

SECOND EDITION

*Anesthesia and
Analgesia
in Laboratory
Animals*

EDITORS:

**Richard E. Fish
Marilyn J. Brown
Peggy J. Danneman
Alicia Z. Karas**



*American College of Laboratory
Animal Medicine Series*



Anesthesia and Analgesia in Laboratory Animals

AMERICAN COLLEGE OF LABORATORY
ANIMAL MEDICINE SERIES

Steven H. Weisbroth, Ronald E. Flatt, and Alan L. Kraus, eds.:

The Biology of the Laboratory Rabbit, 1974

Joseph E. Wagner, and Patrick J. Manning, eds.:

The Biology of the Guinea Pig, 1976

Edwin J. Andrews, Billy C. Ward, and Norman H. Altman, eds.:

Spontaneous Animal Models of Human Disease, volume 1, 1979

Edwin J. Andrews, Billy C. Ward, and Norman H. Altman, eds.:

Spontaneous Animal Models of Human Disease, volume 2, 1980

Henry J. Baker, J. Russell Lindsey, and Steven H. Weisbroth, eds.:

The Laboratory Rat, Volume I: Biology and Diseases, 1979; Volume II: Research Applications, 1980

Henry L. Foster, J. David Small, and James G. Fox, eds.:

The Mouse in Biomedical Research, Volume I: History, Genetics and Wild Mice, 1981, Volume II: Diseases, 1982; Vol. III: Normative Biology, Immunology and Husbandry, 1983; Vol. IV: Experimental Biology and Oncology, 1982

James G. Fox, Bennett J. Cohen, and Franklin M. Loew, eds.:

Laboratory Animal Medicine, 1984

G.L. Van Hoosier, Jr., and Charles W. McPherson, eds.:

Laboratory Hamsters, 1987

Patrick J. Manning, Daniel H. Ringler, and Christian E. Newcomer, eds.:

The Biology of the Laboratory Rabbit, second edition, 1994

B. Taylor Bennett, Christian R. Abee, Roy Henrickson, eds:

Nonhuman Primates in Biomedical Research, Biology and Management, 1995

Dennis F. Kohn, Sally K. Wixson, William J. White, and G. John Benson, eds.:

Anesthesia and Analgesia in Laboratory Animals, 1997

B. Taylor Bennett, Christian R. Abee, Roy Henrickson, eds:

Nonhuman Primates in Biomedical Research, Diseases, 1998

James G. Fox, Lynn C. Anderson, Franklin M. Loew, and Fred W. Quimby, eds.:

Laboratory Animal Medicine, second edition, 2002

Mark A. Suckow, Steven H. Weisbroth, and Craig L. Franklin, eds.:

The Laboratory Rat, second edition, 2006

James G. Fox, Stephen W. Barthold, Muriel T. Davisson, Christian E. Newcomer,
Fred W. Quimby, and Abigail L. Smith, eds.:

*The Mouse in Biomedical Research, second edition, 2007 Volume I: History, Wild Mice,
and Genetics; Volume II: Diseases; Volume III: Normative Biology, Husbandry, and
Models; Volume IV: Immunology, 2007*

Richard E. Fish, Peggy J. Danneman, Marilyn Brown, and Alicia Z. Karas, eds.:

Anesthesia and Analgesia in Laboratory Animals, second edition, 2008

In Preparation:

Jack R. Hessler, Noel Lehner, and Clifford R. Roberts, eds.:

Planning and Designing Research Animal Facilities

For more information on other titles in the ACLAM series, visit our website at

<http://books.elsevier.com/aclam>

ANESTHESIA AND ANALGESIA IN LABORATORY ANIMALS

2ND EDITION

EDITED BY

Richard E. Fish

*Laboratory Animal Resources
College of Veterinary Medicine
North Carolina State University
Raleigh, North Carolina*

Marilyn J. Brown

*Animal Welfare and Training
Charles River Laboratories, Inc.
Wilmington, Massachusetts*

Peggy J. Danneman

*Laboratory Animal Health Services
The Jackson Laboratory
Bar Harbor, Maine*

Alicia Z. Karas

*Department of Clinical Sciences
Cummings School of Veterinary Medicine
Tufts University
North Grafton, Massachusetts*



Amsterdam • Boston • Heidelberg • London • New York • Oxford • Paris
San Diego • San Francisco • Singapore • Sydney • Tokyo
Academic Press is an imprint of Elsevier



Academic Press is an imprint of Elsevier
84 Theobald's Road, London WC1X 8RR, UK
Radarweg 29, PO Box 211, 1000 AE Amsterdam, The Netherlands
30 Corporate Drive, Suite 400, Burlington, MA01803, USA
525 B Street, Suite 1900, San Diego, CA92101-4495, USA

First edition 1997
Copyright © 2008 Elsevier Inc. All rights reserved

No part of this publication may be reproduced, stored in a retrieval system or transmitted in any form or by any means electronic, mechanical, photocopying, recording or otherwise without the prior written permission of the publisher. Permissions may be sought directly from Elsevier's Science & Technology Rights Department in Oxford, UK: phone (+44) (0) 1865 843830; fax (+44) (0) 1865 853333; email: permissions@elsevier.com. Alternatively you can submit your request online by visiting the Elsevier web site at <http://elsevier.com/locate/permissions>, and selecting Obtaining permission to use Elsevier material

Notice

No responsibility is assumed by the publisher for any injury and/or damage to persons or property as a matter of products liability, negligence or otherwise, or from any use or operation of any methods, products, instructions or ideas contained in the material herein. Because of rapid advances in the medical sciences, in particular, independent verification of diagnoses and drug dosages should be made

British Library Cataloguing in Publication Data

A catalogue record for this book is available from the British Library

Library of Congress Cataloging in Publication Data

A catalog record for this book is available from the Library of Congress

ISBN: 978-0-12-373898-1

For information on all Academic Press publications
visit our website at books.elsevier.com

Typeset by Charon Tec Ltd., A Macmillan Company (www.macmillansolutions.com)

Printed and bound in the USA

08 09 10 10 9 8 7 6 5 4 3 2 1

Working together to grow
libraries in developing countries

www.elsevier.com | www.bookaid.org | www.sabre.org

ELSEVIER

BOOK AID
International

Sabre Foundation

Contents

List of Contributors

Preface

List of Reviewers for Chapters in This Volume

Abbreviations

xi

xiii

xv

xvii

Section I—Anatomy, Physiology, and Pharmacology

1

Chapter 1 Anatomy, Physiology, and Effects of Pain

3

*George J. DeMarco and
Peter J. Pascoe*

- I. Definitions 3
- II. Anatomy and Physiology of Nociception 5
- III. Neuropharmacology of Nociception 8
- IV. Neonatal Development and Pain 9
- V. Physiologic Effects of Pain 10
- VI. Neuroplasticity and Pain: Peripheral and Central Sensitization 11
- VII. Pathophysiology of Chronic Pain 14
- References 16

Chapter 2 Pharmacology of Injectable Anesthetics, Sedatives, and Tranquilizers

27

Robert E. Meyer and Richard E. Fish

- I. Introduction 28
- II. Gamma-Aminobutyric Acid Receptor Agonists 29
- III. NMDA-Antagonists 47
- IV. Alpha2-Adrenoceptor Agonists 50
- V. Dopaminergic Receptor Antagonists 54
- VI. Miscellaneous Agents 56
- VII. Local Anesthetics 60
- VIII. Anesthetic Combinations 64
- References 67

Chapter 3 Pharmacology of Inhalation Anesthetics

83

David B. Brunson

- I. Introduction 83
- II. Chemical and Physical Properties 84
- III. Mode of Action 89
- IV. Uptake—Distribution—Elimination 89
- V. Inhaled Anesthetics 90
- VI. Measurement and Qualification of Anesthetic Concentration for Research 92
- VII. Summary 94
- References 94

Chapter 4 Pharmacology of Analgesics

97

James E. Heavner and Dale M. Cooper

- I. Introduction 98
- II. Analgesic-Antipyretic and Anti-Inflammatory Drugs 99
- III. Opioids 109
- IV. α_2 -Adrenergic Agonists 115
- V. NMDA-Receptor Antagonists 117
- VI. Analgesic Adjuvants 118
- VII. Future Prospects 118
- Acknowledgment 118
- References 118

Section II—Monitoring and Equipment

125

Chapter 5 Anesthesia Delivery Systems

127

George A. Vogler

- I. Introduction 128
- II. Compressed Gases 128
- III. Anesthetic Machine Components 130
- IV. Breathing Circuits 141

V. Anesthetic Machines	145	IV. Oversight, Planning, and Organization	224
VI. Ventilators	151	V. Monitoring and Intervention	226
VII. Induction Chambers and Masks	155	VI. Record Keeping	233
VIII. Injectable Anesthetic Delivery Systems	158	VII. Conclusions	233
IX. Equipment for Airway Access and Control	159	References	233
Additional Reading	167		
References	167		
Chapter 6 Monitoring of Anesthesia	171	Section III—Practical Anesthesia and Analgesia of Traditional Laboratory Animal Species	237
<i>Jennifer C. Smith and Peggy J. Danneman</i>			
I. Introduction	171	Chapter 10 Anesthesia and Analgesia for Laboratory Rodents	239
II. Monitoring of the Anesthetized Patient	172	<i>Diane J. Gaertner, Troy M. Hallman, F. Claire Hankenson, and Margaret A. Batchelder</i>	
III. Special Circumstances	180		
IV. Summary and Conclusions	181	I. Introduction	240
Acknowledgement	181	II. Considerations in selection of Anesthetics for Rodents	245
References	181	III. General Anesthetic Plan	249
		IV. Recommended Anesthetic Methods for Routine Use in Rodents	250
		V. Drugs Used as Adjuvants to Primary Anesthetic Agents	261
		VI. Anesthetic Regimens Used for Special Purposes	265
		VII. Other Anesthetics	266
		VIII. Use of Neuromuscular Blocking Agents and Antagonists	266
		IX. Analgesics for mice and rats	268
		X. Anesthesia and Analgesia in Neonatal Mice and Rats	277
		XI. Special Considerations for Postprocedural Monitoring of Rodents	278
		XII. Other Rodents, Including Guinea Pigs, Hamsters, and Gerbils	279
		References	282
Chapter 7 Waste Anesthetic Gas Safety	183	Chapter 11 Anesthesia and Analgesia in Rabbits	299
<i>Jennifer C. Smith</i>		<i>Neil S. Lipman, Robert P. Marini, and Paul A. Flecknell</i>	
I. Introduction	183	I. Introduction	300
II. Potential Health Effects	185	II. Preoperative Considerations	300
III. Sources of Waste Anesthetic Gas	187	III. Methods of Delivery/Administration	306
IV. Evacuation of WAG	188	IV. Parenteral Techniques	310
V. Risk Assessment and Mitigation	189	V. Inhalation Anesthesia	317
VI. Summary and Conclusions	192	VI. Regional Anesthesia	319
References	192	VII. Special Anesthetic Considerations	320
		VIII. Intraoperative Support and Monitoring	321
		IX. Postoperative Considerations	323
		X. Analgesia	324
		References	327
Chapter 8 Strategies for Assessing and Minimizing Pain	195		
<i>Alicia Z. Karas, Peggy J. Danneman, and Joan Cadillac</i>			
I. Introduction	195		
II. Why Prevent Pain?	196		
III. Preprocedural Considerations: Predicting and Preventing Pain	199		
IV. Postprocedural Considerations: Recognizing and Monitoring Pain	206		
V. Summary	213		
References	213		
Chapter 9 Postprocedural Care of Commonly Utilized Research Animal Subjects	219		
<i>Victoria A. Hampshire and Judith A. Davis</i>			
I. Introduction	219		
II. Recruitment and Organization of Space	220		
III. Staffing and Personnel	223		

Chapter 12 Anesthesia and Analgesia in Nonhuman Primates	335	Chapter 15 Anesthesia and Analgesia in Swine	413
<i>Sulli J. Popilskis, Donald R. Lee, and David B. Elmore</i>		<i>Alison C. Smith and M. Michael Swindle</i>	
I. Introduction	336	I. Introduction	414
II. Preanesthetic Considerations	336	II. Breed, Anatomic, and Physiologic Characteristics	414
III. Anesthetic Delivery and Techniques	337	III. Anesthetic Delivery	415
IV. Anticholinergic Drugs	340	IV. Inhalational Anesthesia	417
V. Parenteral Anesthetics	340	V. Injectable Anesthetics and Tranquilizers	419
VI. Inhalational Anesthesia	348	VI. Regional Analgesia	422
VII. Intraoperative Monitoring	351	VII. Analgesia	423
VIII. Intraoperative Support	352	VIII. Intraoperative Monitoring and Support	423
IX. Special Anesthetic Considerations	353	IX. Cardiac Arrhythmias	424
X. Postoperative Care	357	X. Support	424
XI. Analgesia	358	XI. Postsurgical Care	425
References	360	XII. Special Anesthetic Considerations	425
Personal Communications	363	XIII. Cardiopulmonary Bypass	426
		XIV. Summary and Additional Reference Material	431
		Appendix Tables	432
		A1: Dissociative Anesthetics and Combinations	432
		A2: Tranquilizers, Hypnotics, and Sedatives	433
Chapter 13 Anesthesia and Analgesia in Dogs and Cats	365	A3: Miscellaneous Anesthetic and Perioperative Drugs	434
<i>Elizabeth Armitage-Chan</i>		A4: NSAID and Opioid Analgesics	434
I. Introduction	366	A5: Protocol for Routine Surgery without Physiologic Measurements	435
II. Preanesthetic Considerations	366	A6: Protocol for Nonsurvival Teaching Laboratories	435
III. Anesthetic Techniques	368	A7: Opioid Infusion Protocol for Cardiopulmonary Bypass with Cardiac Compromise	435
IV. Preanesthetic Medications	370	References	436
V. Induction of Anesthesia	372		
VI. Anesthetic Maintenance	374	Section IV—Practical Anesthesia and Analgesia of Nontraditional Laboratory Animal Species	441
VII. Monitoring	375		
VIII. Supportive Care	376	Chapter 16 Anesthesia and Analgesia in Ferrets	443
IX. Recovery	377	<i>Jeff Ko and Robert P. Marini</i>	
X. Analgesia	377		
XI. Specific Considerations	380	I. Introduction	443
Suggested Additional Reading	383	II. Preanesthetic Considerations	444
References	383	III. Anesthetic Techniques	444
		IV. Preanesthesia: Sedative and Analgesic Drugs in Ferrets	445
Chapter 14 Anesthesia and Analgesia of Ruminants	385	V. Anesthetic Induction and Maintenance	449
<i>Alexander Valverde and Thomas J. Doherty</i>		VI. Monitoring Techniques	452
I. Introduction	386	VII. Recovery and Pain Management	453
II. Physiological and Anatomical Considerations	386	VIII. Special Considerations	454
III. Premedication	389	IX. Authors' Preferences	454
IV. Induction	395	References	455
V. General Anesthesia	398	Additional Reading	456
VI. Local and Regional Anesthesia	401		
VII. Anesthesia for Husbandry Procedures	404	Chapter 17 Anesthesia and Analgesia in Other Mammals	457
VIII. Monitoring the Anesthetized Patient	405	<i>Jeff Wyatt</i>	
IX. Intraoperative Support	407		
X. Analgesia	407	I. Marsupialia: Marsupials	458
References	408	II. Scandentia and Insectivora: Insectivores	459

III. Rodentia: Nontraditional Species of Laboratory Rodents	462	IV. Anesthetic Techniques	513
IV. Lagomorpha: Pikas, Hares	470	V. Physical Restraint and Handling	514
V. Xenarthra: Edentates (Armadillos)	471	VI. Routes of Drug Administration	514
VI. Chiroptera: Bats	472	VII. Immersion Anesthesia	514
VII. Carnivora: Bears, Hyena	473	VIII. Volatile Anesthesia	515
VIII. Prosimii: Gray Mouse Lemur	475	IX. Injectable Anesthesia	516
References	475	X. Topical/Regional Anesthesia	516
		XI. Preanesthesia/Anesthetic Induction	516
		XII. Anesthetic Maintenance and Monitoring	516
		XIII. Recovery	516
Chapter 18 Anesthesia and Analgesia in Birds	481	XIV. Pain Management/Analgesia	517
<i>John W. Ludders</i>		XV. Field Anesthesia	517
I. Introduction	481	XVI. Larval Anesthesia	517
II. The Pulmonary System: Form, Function, and Implications for Anesthetic Management	483	References	518
III. Specific Considerations for Anesthesia	489		
IV. Euthanasia of Birds	496	Chapter 21 Anesthesia and Restraint of Laboratory Fish	519
V. Recommended Reading	497	<i>Michael Stoskopf and Lysa Pam Posner</i>	
References	497	I. Introduction	519
		II. Fish and Pain	520
Chapter 19 Anesthesia and Analgesia in Reptiles	501	III. Physical Restraint of Fish	520
<i>Dorcas P. O'Rourke and Audrey L. Jenkins</i>		IV. Basic Principles and Application of Anesthesia in Fish	521
I. Introduction	501	V. Monitoring	522
II. General Considerations	501	VI. Anesthetic Agents	523
III. Preanesthetic Evaluation and Preparation	503	VII. Analgesic Agents	531
IV. Anesthetic Techniques	503	VIII. Nonchemical Methods	531
V. Physical Restraint and Handling	503	IX. Euthanasia in Fish	532
VI. Anesthesia of Venomous Species	503	References	533
VII. Routes of Drug Administration	505		
VIII. Inhalant Anesthesia	505	Chapter 22 Anesthesia and Analgesia of Invertebrates	535
IX. Injectable Anesthesia	506	<i>Cornelia Gunkel and Gregory A. Lewbart</i>	
X. Local/Regional Anesthesia	506	I. Introduction	535
XI. Total Intravenous Anesthesia	506	II. Anesthesia	536
XII. Neuromuscular Blocking Agents	506	III. Pain and Analgesia in Invertebrates	542
XIII. Preanesthesia	506	IV. Euthanasia	542
XIV. Anesthetic Induction	507	References	543
XV. Anesthetic Maintenance	507		
XVI. Monitoring	508	Section V—Special Topics in Anesthesia and Analgesia of Laboratory Animals	547
XVII. Recovery	508		
XVIII. Pain Management/Analgesia	508	Chapter 23 Pain Testing in the Laboratory Mouse	549
XIX. Prolonged/Repeated Anesthesia	508	<i>Dale J. Langford and Jeffrey S. Mogil</i>	
References	509	I. Introduction	549
		II. Experimental Models of Acute/Tonic Pain	550
Chapter 20 Anesthesia and Analgesia in Amphibians	511	III. Experimental Models of Chronic Pain	554
<i>Dorcas P. O'Rourke and Audrey L. Jenkins</i>		IV. Modulating Factors	556
I. Introduction	511	V. New Directions in Animal Pain Testing	557
II. General Considerations	511	References	557
III. Preanesthetic Evaluation and Preparation	512		

Chapter 24 Ethical Issues in Anesthesia and Analgesia in Laboratory Animals	561	VIII. Prevention of Post-Operative Pre-Term Labour	601
<i>Larry Carbone and Nelson Garnett</i>		IX. Functional Maturity of Key Organ Systems in Newborn Animals	601
I. Introduction	561	X. Anaesthesia of Neonatal Animals	602
II. Ethical Issues in Laboratory Animal Anesthesia, Analgesia, and Pain Management	564	XI. Supportive Measures During Neonatal Anaesthesia	603
Additional Reading	567	XII. Post-Operative Period	604
References	567	XIII. Neonatal Analgesia	604
		XIV. Concluding Comments	605
		References	606
Chapter 25 Regulatory Issues	569	Chapter 28 Novel Delivery Systems for Analgesic Drugs in Laboratory Animals	609
<i>Laura A. Conour, Sonja T. Chou, and Lynn C. Anderson</i>		<i>Lisa Krugner-Higby, Lesley J. Smith, and Timothy D. Heath</i>	
I. Introduction	569	I. Introduction	609
II. US Animal Welfare Regulations, Policies, and Standards	570	II. Other Approaches to Analgesic Drug Delivery in Laboratory Animals	611
III. Drug Enforcement Regulations and Policies	573	III. Conclusion	616
IV. Occupational Health and Safety Considerations	576	References	616
V. International Considerations	577	Chapter 29 Nonpharmacologic Pain Control	619
References	579	<i>Sara Savage</i>	
Chapter 26 Management of Chronic Pain	581	I. Introduction	619
<i>George J. DeMarco</i>		II. Preventative Strategies	620
I. Introduction	581	III. Nonpharmacologic Interventions	622
II. Diagnosis	583	IV. Summary and Future Scope	627
III. Treatment	585	References	627
References	588	Chapter 30 Anesthetic Considerations for In Vivo Imaging Studies	629
Chapter 27 Anaesthesia and Analgesia in the Foetus and Neonate	593	<i>Anthony Nicholson and Brenda Klaunberg</i>	
<i>J.C. Murrell, D.J. Mellor, and C.B. Johnson</i>		I. Introduction	629
I. Introduction	594	II. Imaging Modalities	630
II. Is the Foetus Conscious?	594	III. Anesthetic Considerations	633
III. Does Foetal Unconsciousness Persist During Noxious Interventions?	596	IV. Imaging-Specific Considerations	636
IV. Does Noxious Stimulation Activate the Foetal Stress Response?	597	V. Anesthesia	636
V. Might Noxious Stimulation of the Foetus Cause Long-Term Changes in Pain Processing?	597	References	637
VI. Anaesthesia of the Dam for Foetal Surgery	598	<i>Index</i>	641
VII. Epidural Analgesia/Anaesthesia	600		

This page intentionally left blank

List of Contributors

Number in parentheses indicate the pages on which the authors' contributions begin.

- LYNN C. ANDERSON (569), Charles River Laboratories, Inc.,
Wilmington, MA 01887
- ELIZABETH ARMITAGE-CHAN (365), Department of Veterinary
Clinical Sciences, Royal Veterinary College, Queen Mother
Hospital, North Mymms, Hatfield AL9 7TA, UK
- MARGARET A. BATCHELDER (239), Bristol-Myers Squibb Phar-
maceutical Research Institute, Wallingford, CT 06492-7660
- DAVID B. BRUNSON (83), Department of Surgical Sciences,
University of Wisconsin, School of Veterinary Medicine,
Madison, WI 53706
- JOAN CADILLAC (195), Laboratory Animal Health Services, The
Jackson Laboratory, Bar Harbor, ME 04609
- LARRY CARBONE (561), Laboratory Animal Resource Center,
University of California San Francisco, San Francisco, CA
94143-0564
- DALE M. COOPER (97), Veterinary Resources, Eli Lilly and
Company, Greenfield, IN 46140
- LAURA A. CONOUR (569), Charles River Laboratories, Inc.,
Wilmington, MA 01887
- PEGGY J. DANNEMAN (171, 195), Laboratory Animal Health
Services, The Jackson Laboratory, Bar Harbor, ME 04609
- JUDITH A. DAVIS (219), Office of Laboratory Animal Science,
Division of Intramural Research (DIR), National Institute on
Alcohol Abuse and Alcoholism, National Institutes of Health,
Bethesda, MD 20892
- GEORGE J. DEMARCO (3, 581), Yale University School of
Medicine, New Haven, CT 06520-8016
- THOMAS J. DOHERTY (385), Department of Large Animal Clin-
ical Sciences, College of Veterinary Medicine, University of
Tennessee, Knoxville, TN 37996-0001
- DAVID B. ELMORE (335), Charles River Laboratories, Inc.,
San Diego, CA 92107-3652
- RICHARD E. FISH (27), College of Veterinary Medicine, NC
State University, Raleigh, NC 27606-1499
- PAUL A. FLECKNELL (299), Medical School, Comparative
Biology Centre, Newcastle NE2 4HH, UK
- DIANE J. GAERTNER (239), School of Veterinary Medicine,
University of Pennsylvania, Philadelphia, PA 19104
- NELSON GARNETT (561), Johns Hopkins University, Baltimore,
MD 21205-1911
- CORNELIA GUNKEL (535), Department of Clinical Sciences,
College of Veterinary Medicine, Oregon State University,
Corvallis, OR 97331-4803
- TROY M. HALLMAN (239), School of Veterinary Medicine,
University Laboratory Animal Resources, Philadelphia, PA
19104
- VICTORIA A. HAMPSHIRE (219), US Food and Drug Administra-
tion, Center for Devices and Radiological Health, Rockville,
MD 20855
- F. CLAIRE HANKENSON (239), Department of Pathobiology,
School of Veterinary Medicine, University Laboratory Ani-
mal Resources, University of Pennsylvania, Philadelphia, PA
- TIMOTHY D. HEATH (609), School of Pharmacy, Madison, WI
53706
- JAMES E. HEAVNER (97), Physiology Department of Anes-
thesiology, Health Sciences Center, Texas Tech University,
Lubbock, TX 79416
- AUDREY L. JENKINS (501, 511), Department of Compara-
tive Medicine, East Carolina University Brody School of
Medicine, Greenville, NC 27834
- CRAIG B. JOHNSON (593), Institute of Veterinary, Animal and
Biomedical Sciences, Massey University, Palmerston North
4410, New Zealand
- ALICIA Z. KARAS (195), Department of Clinical Sciences, Cum-
mings School of Veterinary Medicine at Tufts University,
North Grafton, MA 01536
- BRENDA KLAUNBERG (629), Mouse Imaging Facility, National
Institute of Neurological Disorders and Stroke, National
Institutes of Health, Bethesda, MD 20892-1060
- JEFF KO (443), Department of Veterinary Clinical Sciences,
School of Veterinary Medicine, Purdue University, West
Lafayette, IN 47907-2026

- LISA KRUGNER-HIGBY (609), Research Animal Resources Center, University of Wisconsin, Madison, WI 53705-4098
- DALE J. LANGFORD (549), Department of Psychology, McGill University, Montreal, Quebec, H3A 1B1 Canada
- DONALD R. LEE (335), Charles River Laboratories, Inc., Alamogordo Primate Facility, Holloman Air Force Base, NM 88330
- GREGORY A. LEWBART (535), College of Veterinary Medicine, North Carolina State University, Raleigh, NC 27606
- NEIL S. LIPMAN (299), Memorial Sloan-Kettering Cancer Center, New York, NY 10021
- JOHN W. LUDDERS (481), Department of Clinical Sciences, College of Veterinary Medicine, Cornell University, Ithaca, NY 14853
- ROBERT P. MARINI (299, 443), MIT-DCM, Cambridge, MA 02139
- DAVID J. MELLOR (593), Animal Welfare Science and Bioethics Centre and Institute of Food, Nutrition and Human Health, Massey University, Palmerston North, New Zealand
- ROBERT E. MEYER (27), Department of Clinical Sciences, College of Veterinary Medicine, Mississippi State, MS 39762-6100
- JEFFREY S. MOGIL (549), Department of Psychology, McGill University, Montreal, Quebec, H3A 1B1 Canada
- JOANNA C. MURRELL (593), Department of Clinical Veterinary Science, University of Bristol Veterinary School, North Somerset BS40 5DU, UK
- ANTHONY NICHOLSON (629), The Jackson Laboratory, Bar Harbor, ME 04609
- DORCAS P. O'ROURKE (501, 511), The Brody School of Medicine, East Carolina University, Greenville, NC 27834
- LYSA PAM POSNER (519), College of Veterinary Medicine, North Carolina State University, Raleigh, NC 27606
- PETER J. PASCOE (3), Department of Surgical and Radiological Sciences, School of Veterinary Medicine, University of California, Davis, CA 95616
- SULLI J. POPILSKIS (335), Barton' West End Farm Facility, Oxford, NJ 07863
- SONJA (SCOUT) CHOU (569), Charles River Laboratories, Wilmington, MA 01887
- SARA SAVAGE (619), Department of Comparative Medicine, Genzyme Corporation, Framingham, MA 01701
- MICHAEL STOSKOPF (519), College of Veterinary Medicine, North Carolina State University, Raleigh, NC 27606
- ALISON C. SMITH (413), Department of Comparative Medicine, Medical University of South Carolina, Charleston, SC 29425
- JENNIFER C. SMITH (171, 183), LA Consulting Services, Newbury Park, CA 91320
- LESLEY J. SMITH (609), Department of Surgical Sciences, School of Veterinary, University of Wisconsin, Madison, WI 53706
- M. MICHAEL SWINDLE (413), Department of Comparative Medicine, Medical University of South Carolina, Thurmond/Gazes Research Building, Charleston, SC 29425
- ALEXANDER VALVERDE (385), Department of Clinical Studies, Ontario Veterinary College, University of Guelph, Guelph, Ontario, N1G 2W1 Canada
- GEORGE A. VOGLER (127), Department of Comparative Medicine, St. Louis University Medical School, St. Louis, MO 63104
- JEFF WYATT (457), Department of Comparative Medicine, University of Rochester School of Medicine and Dentistry, Rochester, NY 14642

Preface

Like the first edition, this book presents a comprehensive review of anesthesia and analgesia as applied to animals used in a research setting. It differs in approach from other veterinary anesthesia texts in that it takes into account the research environment as well as a wide range of species, and will be useful to those engaged in biomedical research, including veterinarians, investigators, technical staff, and institutional animal care and use committees.

In the biomedical research setting, it is important not only to choose agents and methods that ensure the well-being of the research animal, but also to select agents that allow scientifically valid and reproducible observations to be obtained with minimal or no effect on research outcomes. Wherever possible, background information and appropriate references have been provided to alert the reader to important effects and interactions of various drugs on physiology and metabolism. Where appropriate, authors have indicated key references in *italic font*.

The second edition has been updated, expanded, and partially reorganized. There are five sections covering topics that range from basic science, to practical applications and recommendations for anesthesia and analgesia, to ethics, regulations, and current topics in pain research and pain alleviation.

Section I provides the reader with detailed reviews of our current understanding of the anatomy/physiology of pain and the pharmacology of the agents used to relieve pain. Each of these chapters has a lengthy bibliography, because the scope of the reviews far exceeds that which can be dealt with in subsequent chapters. Those who have limited experience in administering anesthetics and analgesics to laboratory animals should consult these chapters for the background information required to understand the nature of these agents, including their mechanism of action.

Section II contains chapters that provide thorough discussions of the practical aspects of providing and monitoring anesthesia,

recognizing and assessing pain in research animals, and supporting those animals in the post-procedural period. Although the later species-specific chapters address some of these issues, this section provides useful discussions of essential topics that would be useful for all readers.

Sections III and IV include chapters that are oriented toward species-specific aspects of anesthesia and analgesia in traditional and non-traditional species, respectively. They provide the reader with a comprehensive discussion of agents, methods, and procedures from peer-reviewed reports as well as unpublished observations of the authors. Because the published data on many agents and species are quite limited, unpublished observations are included to give the reader a useful starting point. These observations are identified as such. To further aid those who have limited experience in anesthetizing a particular species, the authors' preferences for agents and dosages are noted. The reader is encouraged to consult the extensive reference lists for more detail on specific agents and their use in specific research settings.

The final section, entitled *Special Topics in Anesthesia and Analgesia of Laboratory Animals*, assembles chapters intended to highlight current topics of both general relevance to all who are involved with the minimization of pain and distress in laboratory animals (e.g., ethics and regulations) and more specialized areas of current interest (i.e., pain models, chronic pain, pain in the fetus and neonate, imaging studies, and new frontiers in pain control).

This volume is one of a series of texts that the American College of Laboratory Animal Medicine has sponsored since 1974 as a means to nurture continuing education for its diplomates, trainees, and their colleagues who have responsibilities for the care and use of laboratory animals. We are indebted to the chapter authors for the dedication and effort each extended during the development of this book, and to the authors and editors of the first edition, whose work in

many cases provided the foundation for the current effort. We thank the reviewers whose suggestions and comments were extremely helpful to the chapter authors and editors. Finally, this book could not have been completed without the support and resources of the authors', editors', and reviewers' parent institutions. Royalties from the ACLAM-sponsored

texts are used to help support future continuing education programs.

RICHARD E. FISH
MARILYN J. BROWN
PEGGY J. DANNEMAN
ALICIA Z. KARAS

List of Reviewers for Chapters in This Volume

Andrutis, Karl A.	Division of Teaching and Research Resources, Tufts University, Cummings School of Veterinary Medicine, North Grafton, MA
Baccanale, Cecile L.	Marshall Bioresources, North Rose, NY
Bayne, Kathryn A.	Pacific Rim Activities, AAALAC International, Waikoloa, HI
Brady, Alan G.	Comparative Medicine, University South Alabama, Mobile, AL
Clemons, Donna J.	Laboratory Animal Medicine, Covance Laboratories, Inc, Madison, WI
Cooper, Dale	Lilly Research Laboratories, Eli Lilly & Co, Greenfield, IN
Dennis, John U.	SAIC – Frederick Lab Animal Science Program, National Cancer Institute, Bethesda, MD
Flecknell, Paul A.	Comparative Biology Centre, The Medical School, Newcastle-Upon-Tyne, UK
Foley, Patricia L.	Office of Animal Welfare, University of Virginia, Charlottesville, VA
Harper, James S.	Brown University, Providence, RI
Heard, Darryl J.	University of Florida, Gainesville, FL
Kraus, A. Lanny	St. Helena, SC
Lee-Paritz, David E.	Comparative Medicine, Genzyme Corporation, Farmingham, MA
Mook, Deborah	Emory University, Atlanta, GA
Murphy, Stephanie J.	Department of Anesthesiology and Peri-Operative Medicine, Oregon Health & Science University, Portland, OR
Myers, David D.	Laboratory Animal Health Services, The Jackson Laboratory, Bar Harbor, ME
Nicholson, Anthony I.	Animal Husbandry and Performance, The Jackson Laboratory, Bar Harbor, ME
Paster, Eden V.	Department of Anesthesiology and Peri-Operative Medicine, Oregon Health & Science University, Portland, OR
Perkins, Scott E.	Division of Laboratory Animal Medicine, Tufts University, Boston, MA
Portnoy, Lisa	Warren G. Magnusen Clinical Center, National Institutes of Health, Bethesda, MD
Prattis, Susan M.	VIP Veterinary Hospital, PC, New York, NY
Reuter, Jon D.	Animal Resources Department, The Salk Institute, La Jolla, CA
Schech, Joseph Mat	National Institute of Child Health and Human Development, Bethesda, MD
Senter, Lucy H.	Laboratory Animal Resources, Mississippi State University, Mississippi State, MS

Turner, Patricia V.	Department of Pathobiology, Ontario Veterinary College, Guelph, ON, Canada
Underwood, Wendy J.	Eli Lilly & Co, Greenfield, IN
Wilson, Ronald P.	Comparative Medicine, Penn State University College of Medicine, Hershey, PA

Abbreviations

μCT or microCT	Micro-computed tomography	AST	Aspartate aminotransferase
μg	microgram	atm	Atmospheres of pressure
μPET or microPET	Micro-positron emission tomography	AD	Atopic dermatitis
¹⁸ F-FDG	2-deoxy-2-[¹⁸ F]fluoro-D-glucose	ATP	adenosine triphosphate
2-PE	2-phenoxyethanol	AtrE	Atropinesterase
3Rs	Replacement, reduction, refinement	AV	Attending veterinarian
5-HT	5-hydroxy-tryptamine (serotonin)	AVMA	American Veterinary Medical Association
6-MAM	6-monoacetylmorphine	AWA	Animal Welfare Act
AAALAC	Association for the Assessment and Accreditation of Laboratory Animal Care – International	AWAR	Animal Welfare Act regulations
		AWIC	Animal Welfare Information Center
		AWR	Animal Welfare Act regulations
AALAS	American Association for Laboratory Animal Science	BDNF	Brain derived neurotrophic factor
AANA	American Association of Nurse Anesthetists	BG	Blood glucose
		BIS	Bispectral Index
ABG	Arterial Blood Gases	BP	Blood pressure
AC	Animal Care (APHIS)	BSC	Biosafety cabinet
ACGIH	American Conference of Governmental Industrial Hygienists	BUN	Blood urea nitrogen
		CBC	Complete blood count
ACH	Acetylcholinesterase	CBF	Cerebral blood flow
ACLAM	American College of Laboratory Animal Medicine	CCAC	Canadian Council on Animal Care
		CCD	Charge-coupled device
ACTH	Adrenocorticotrophic hormone	CCI	Chronic constriction injury
ACVA	American College of Veterinary Anesthesiologists	CFA	Compete Freund's adjuvant
		CFR	Code of Federal Regulations
ADH	Antidiuretic hormone	CGRP	Calcitonin gene related product
AEP	Auditory evoked potential	CI	Cardiac Index
AI	Apneic index	CIP	Chronic inflammatory pain
ALT	Alanine aminotransferase	CK	Creatine kinase
AMPA	α-amino-3-hydroxyl-5-methyl-4-isoxazolepropionic acid	Cl ⁻	Chloride
		cm	Centimeter
AP	Action potential	cm H ₂ O	Centimeter of water
APHIS	Animal and Plant Health Inspection Service	CMS	Composite measurement scale
		CNS	Central nervous system
APL	Adjustable pressure limiting valve	CO ₂	Carbon dioxide
APV	Association of Primate Veterinarians	COX 1, 2 and 3	Three different forms of Cyclooxygenase
AQUI-S	AQUI-S (2-methoxy-4 propenyl phenol)	CPB	Cardiopulmonary bypass
ASA	American Society of Anesthesiologists	CREB	CAMP responsive element-binding protein
ASIC	Acid-sensing ion channels		

CRF	Corticotropin-releasing factor	H-CFCs	Halogenated chlorofluorocarbons (halothane, enflurane, isoflurane)
CRH	Corticotrophin releasing hormone	HIV	Human immunodeficiency virus
CRI	Constant rate infusions	HPA	Hypothalamic-pituitary-adrenal axis
CRT	Capillary refill time	HR	Heart rate
CS	Central sensitization	HRV	Heart rate variability
CSA	Controlled Substances Act	I:E ratio	Inspiratory-expiratory phase time
CVP	Central venous pressure	IACUC	Institutional Animal Care and Use Committee
CYP2D6	Cytochrome P2D6	IASP	International Association for the Study of Pain
D5W	Dextrose 5% in Water	ICP	Intracranial pressure
DEA	Drug Enforcement Agency	ICS	Intercostal space
DEXA	Dual-energy X-ray absorptiometry	ID	Inner diameter
DH	Dorsal horn	IIN	Inhibitory interneurons
DHPN	Dorsal horn projection neurons	IL-1	Interleukin-1
DMSO	Dimethyl sulfoxide	ILAR	Institute for Laboratory Animal Research
DPPC	Dipalmitoyl phosphatidyl choline	IM	Intramuscular, intramuscularly
DISS	Diameter index safety system	IO	Institutional Official
DP	Prostaglandin receptor	IP	Intraperitoneal, intraperitoneally
DRG	Dorsal root ganglion	IP	Prostaglandin receptor
EAA	Excitatory amino acids	IPC	Intrapulmonary chemoreceptors
ECG	Electrocardiogram, electrocardiography	IPPV	Intermittent positive pressure ventilation
ED ₅₀	Effective dose when 50% of subjects are affected	IRAC	Interagency Research Animal Committee
ED ₉₅	Effective dose when 95% of subjects are affected	IT	Intrathecal
EEG	Electroencephalogram, electroencephalography	IV	Intravenous, intravenously
EMS	Electrical muscle stimulation	IVBP	Invasive blood pressure
EP	Prostaglandin receptor	IVRA	Intravenous regional anesthesia
EP-1	Prostaglandin receptor	kg	Kilogram
EPSP	Excitatory postsynaptic potential	KLH	Keyhole limpet hemocyanin
ERK-CREB	Extracellular signal-regulated kinase-CREB	kPa	Kilopascal
ET	Embryo transfer	L	Liter
ETCO ₂	End-tidal carbon dioxide partial pressure	LA	Left arm
F _a	Arterial gas	LAWA	Laboratory Animal Welfare Act of 1966
FASEB	The Federation of American Societies for Experimental Biology	LDH	Lactate dehydrogenase
FDA	Food and Drug Administration	LDI	Laser Doppler imaging
F _E CO ₂	Expired CO ₂ concentration	LED	Light emitting diode
FHCs	Fluorinated Hydrocarbons (sevoflurane and desflurane)	LL	Left leg
F _i	Inspired gas	LMA	Laryngeal Mask Airway
fMRI	Functional magnetic resonance imaging	LOX	Lipoxygenase
FP	Prostaglandin receptor	lpm	Liters per minute
GABA	Gamma-amino-butyric acid	LPS	Lipopolysaccharide
gm	gram	LRS	Lactated Ringer's solution
GRAS	Generally regarded as safe	LTP	Long term potentiation
GTE	Given to effect	M1	1st metabolite
Guide	<i>Guide for the Care and Use of Laboratory Animals</i>	MAC	Minimal Alveolar Concentration
		MAP	Mean arterial pressure
		MAPK	Mitogen activated protein kinase
		MD	Medical Doctor
		mg	Milligrams
		MgCl ₂	Magnesium chloride
		mGlu5	Metabotropic glutamate receptor 5
		MH	Malignant hyperthermia

MHz	Megahertz	PEEP	Positive end-expiratory pressure
ml	Milliliter	PELs	Permissible exposure limits
mm	Millimeter	P _E O ₂	Oxygen in end-parabronchial gas
mmHg	Millimeters of mercury	PET	Positron-emission tomography
MOF	Methoxyflurane	PG	Prostaglandin
MRI	Magnetic resonance imaging	PGD2, PGE2,	Different prostaglandins
MRI/S	Magnetic resonance imaging or spectroscopy	PGG2, PGF2a,	
mRNA	Messenger RNA (ribonucleic acid)	PGH2, PGI2	
MS-222	Tricaine methanesulfonate	PC	Phosphatidyl Choline
		PHS	Public Health Service
		PIMs	Pulmonary intravascular macrophages
N ₂	Nitrogen		
N ₂ O	Nitrous oxide	ppm	Parts per million
NASA	National Aeronautics and Space Administration	psi	Pounds per square inch (pressure)
		psig	Pounds per square inch gauge
N _v	Voltage gated sodium ion channels	PSL	Partial sciatic nerve ligation
NE	Norepinephrine	PT	Prothrombin Time
NHP	Non-human primates	PTT	Partial Thromboplastin Time
NIBP	Non-invasive blood pressure	PVG	Periventricular grey
NIH	National Institutes of Health	q30 min, q20–30 min, etc	refers to “every 30 minutes”, or “every 20–30 min”
NIOSH	National Institute of Occupational Safety and Health		
NK	Natural killer (cell)	RA	Right arm
NK-1	Neurokinin-1	RBC	Red blood cell
NMB	Neuromuscular blocker	REL	Recommended Exposure Limits
NMBD	Neuromuscular blocking agent drug	REM	Rapid eye movement
NMDA	<i>N</i> -methyl-D-aspartic acid	RVM	Rostroventral medulla
NMES	Neuromuscular electrical stimulation		
N-NOC	Non-nociceptive specific neurons	SC	Subcutaneous
NO	Nitric oxide	SDS	Simple descriptive scale
NP	Neuropathic pain	SHF	Simian hemorrhagic fever
NRC	National Research Council	SHR	Spontaneously hypertensive rat
NRS	Numeric rating scale	SHT	Spinohypothalamic tract
NS	Nociceptive specific neurons	SIV	Simian immunodeficiency virus
NSAID	Non-steroidal antiinflammatory drug	SMT	Spinomesencephalic tract
NWP	New world primate	SNI	Spared nerve injury
		SNL	Spinal nerve ligation
O ₂	Oxygen	SNR	Signal-to-noise ratio
OD	Outer diameter	SNS	Sympathetic nervous system
OLAW	Office of Laboratory Animal Welfare	SP	substance P
OSHA	Occupational Safety and Health Administration	SPECT	Single-photon emission computed tomography
		SPF	Specific Pathogen Free
P.L.	Public Law	SQ	Subcutaneous
PA	Primary afferent	SRT	Spinoreticular tract
PA	Pulmonary artery	STT	Spinohthalamic tract
PaCO ₂	Arterial partial pressure of carbon dioxide		
PAG	Periaqueductal grey	TBE	Tribromoethanol
PaO ₂	Arterial partial pressure of oxygen	TENS	Transcutaneous electrical nerve stimulation
PCO ₂	Partial pressure of carbon dioxide		
PCV	Packed cell volume	TIVA	Total intravenous anesthesia
P _E CO ₂	Carbon dioxide in end-parabronchial gas	TLV	Threshold Limit Values
		TNF	Tumor necrosis factor

TP	Thromboxane receptor	UN	United Nations
trkB	Tyrosine kinase B	UOP	Urinary output
TRPs	Transient receptor potential ion channels	US	United States
TRPV1	Transient receptor potential, family V, member 1	USDA	United States Department of Agriculture
TTX	Tetrodotoxin	V/Q	Ventilation/perfusion
TWA	Time weighted average	VAP	Vascular access port
TxA2	Thromboxane A2	VAS	Visual analog scale
		VBG	Venous blood gases
		VLF	Ventrolateral funiculus
U.S. Government Principles	“U.S. Government Principles for the Utilization and Care of Vertebrate Animals Used in Testing, Research, and Training”	VPC	Ventricular premature contractions
UK	United Kingdom	WAG	Waste anesthetic gases;
		WDR	Wide dynamic range neurons
		WHO	World Health Organization

Section I

Anatomy, Physiology, and Pharmacology

This page intentionally left blank

Anatomy, Physiology, and Effects of Pain

George J. DeMarco and Peter J. Pascoe

I. Definitions	3
A. Pain	3
II. Anatomy and Physiology of Nociception	5
A. Nociception	5
III. Neuropharmacology of Nociception	8
A. Excitatory Neurotransmitters and Receptors	9
B. Inhibitory Neurotransmitters and Receptors	9
IV. Neonatal Development and Pain	9
A. Pain in the Neonate	10
B. Developmental Effects of Pain	10
V. Physiologic Effects of Pain	10
A. Neuroendocrine Response	10
B. Cardiovascular Effects	11
C. Pulmonary Compromise	11
D. Miscellaneous Effects	11
VI. Neuroplasticity and Pain: Peripheral and Central Sensitization	11
A. Peripheral Sensitization	11
B. Central Sensitization	12
VII. Pathophysiology of Chronic Pain	14
A. Role of Neuroplasticity and Sensitization	14
B. Etiologies	16
References	16

I. DEFINITIONS

A. Pain

Pain has been defined by the International Association for the Study of Pain (IASP) as “an unpleasant sensory and emotional experience associated with actual or potential tissue damage, or described in terms of such damage” (Merskey and Bogduk,

1994). The IASP has also added the following comments: “The inability to communicate verbally does not negate the possibility that an individual is experiencing pain and is in need of appropriate pain-relieving treatment,” and “pain is always subjective.” Irrespective of statements regarding verbal communication, this is a human description for pain, based on the experience of physicians. Molony and Kent have used the following for an animal-specific definition of pain: “an aversive

sensory, emotional experience representing an awareness by the animal of damage or threat to the integrity of its tissues (note, there may not be any damage); it changes the animal's physiology and behavior to reduce or avoid damage, reduce the likelihood of recurrence, and to promote recovery; non-functional pain occurs when the intensity or duration of the experience is not appropriate for the damage sustained (especially if none exists) and when physiological and behavioral responses are unsuccessful in alleviating it." This definition is predicated on animal pain having similar purpose and significance but not in equivalence to human pain (Molony, 1997; Molony and Kent, 1997). It puts pain in the context of an evolutionary survival mechanism by which the animal recognizes and learns to avoid injury. This definition also addresses forms of pain that serve no known function and situations where the animal has exhausted its ability to adapt or compensate and is condemned to suffer.

Although neither definition has been universally accepted for animals, it is interesting that both human and animal definitions squarely cast pain as an experience. The scientific and philosophical arguments for or against animal pain are beyond the scope of this work. Although the debate continues, the consensus among veterinarians and a growing number of neuroscientists is that animals do feel pain, and this volume is predicated on this concept.

1. *Acute Pain*

Acute pain usually has a proximate cause and often serves an essential protective function by associating potentially damaging noxious stimuli with an unpleasant sensation (Woolf, 2004). It can last from seconds to days, and perhaps longer; some have suggested somewhat arbitrary time frames even up to 3 months for humans. Acute pain can be further characterized as physiologic or clinical. Physiologic pain, sometimes referred to as nociceptive pain, is an early-warning system that aids in protecting the body from tissue damage by physical, thermal, or chemical threats (Woolf and Salter, 2000). This type of pain is initiated by the activation of high-threshold nociceptive neurons by noxious stimuli that produce minimal tissue damage, is highly localized to the site of nociceptor activation, and is transient. Another important feature of physiologic pain is that neurophysiologic and subjective responses are closely tied and proportional to the intensity of the inciting stimulus (Casey et al., 1996; Cervero and Laird, 1996; Granovsky et al., 2005). Nociceptive pain initiates physiologic and avoidance behaviors accompanied by protective reflexes, all of which serve to prevent or limit tissue damage. (Nociception is discussed in detail below. Note that the term, nociceptive pain, is also commonly used to distinguish pain arising from nociceptors, from neuropathic pain (NP), i.e., some kind of centrally mediated pain resulting from nerve injury or changes in central processing.)

Clinical pain refers to prolonged unpleasant sensations arising from significant tissue damage. In contrast to physiologic

pain, clinical pain induces augmented or abnormal signal processing, may be spontaneous, and may be characterized by hypersensitivity, hyperalgesia, and allodynia (see definitions below), pain at the site of injury (primary allodynia and/or hyperalgesia), and pain in surrounding noninjured tissues (secondary mechanical allodynia and/or hyperalgesia) (Merskey and Bogduk, 1994). The primary causes of clinical pain are tissue inflammation or damage to peripheral or central neurons (neuropathic); thus, the number and type of initiating conditions or events (trauma, surgery, infection) are quite extensive. In some cases, such as cancer-associated pain, amputations, or vertebral disk prolapse, both inflammatory and neuropathic mechanisms are at work. Clinical pain may serve a useful biologic function by coupling pain to tissue healing, thus, helping limit further injury during the recovery process. However, in many instances, excessive inflammation develops or damaged nervous tissue functions abnormally, and clinical pain becomes a disease, serving no benefit to the individual. Any potential benefits of clinical pain should not be taken as evidence that pain is an acceptable means of restraint or that it should be untreated. Besides ethical considerations, it is generally accepted that untreated pain significantly increases morbidity and mortality.

2. *Chronic Pain*

In human medicine, chronic pain has been defined as "pain which persists past the normal time of healing" (Bonica, 1953). This definition has significant shortcomings since healing may never occur in chronic-pain-associated diseases like arthritis, may never be recognized, as in forms of NP, or may remit and relapse over time. A more useful definition is that chronic pain is said to be present when the pain continues beyond the stage where it is useful to protect the region, or is persistent and may not have a clearly identifiable cause. The IASP has adopted temporal endpoints based on common medical experience to classify chronic pain. The IASP regards 3 months of pain as the most expedient point at which the transition from acute to chronic nonmalignant pain can be defined (Merskey et al., 1994). (See additional discussion in the chapter Management of Chronic Pain.)

3. *Pain Threshold*

Pain threshold is the least experience of pain an individual can recognize. It has also been incorrectly defined as the minimum intensity or duration of a stimulus perceived as pain, an approach based on the external stimulus and not the experience of the individual (Merskey and Bogduk, 1994). Thresholds for a given stimulus are relatively consistent across species if applied in a similar fashion. This suggests that nociception is evolutionarily conserved as a mechanism to prevent injury. Interindividual, species, or strain variability does occur and can result from several factors including skin thickness, perfusion,

rate of stimulus application, and the stress level of the individual. Recent evidence suggests that genetic factors play a prominent role in pain threshold, as well. Polymorphisms in genes coding for catechol-*O*-methyltransferase, opioid receptors, transient receptor potential A subtype 1 channels, and fatty acid hydroxylase have been linked to a variation in pain threshold (Diatchenko et al., 2006; Kim et al., 2006; Mogil et al., 2005). Female gender is associated with lower pain thresholds in humans and, although unclear, the underlying mechanisms seem to involve sociobiologic phenomena (Pool et al., 2007; Shinal and Fillingim, 2007; Wiesenfeld-Hallin, 2005). Sex has not been conclusively demonstrated to influence pain thresholds in animals.

4. *Pain Tolerance*

Pain tolerance is the greatest level of pain an individual is willing to tolerate. As with threshold, tolerance is properly defined by an individual's subjective experience of pain; it is not a measurement of external stimuli (Merskey and Bogduk, 1994). Tolerance is primarily a human concept based on communication of a point at which an individual can no longer cope with pain. People exhibit significant variability for pain tolerance, which is influenced by many factors including age, gender, ethnicity, genetics, anxiety, stress, distraction, sleep deprivation, and drugs (Forys and Dahlquist, 2007; George et al., 2007; Magora et al., 2006; Miller and Newton, 2006; Onen et al., 2001; Rahim-Williams et al., 2007; Thompson et al., 2007). This concept similarly applies to animals and may help explain variation in species and individual responses to noxious stimuli and clinical pain.

5. *Hyperalgesia*

Hyperalgesia is an exaggerated response to a stimulus that would normally be painful.

6. *Hypersensitivity*

Hypersensitivity refers to reduced threshold to noxious stimuli.

7. *Allodynia*

Allodynia is the pain induced by a non-noxious stimulus.

8. *Analgesia*

Analgesia is the absence of pain in response to stimulation that would normally be painful.

II. ANATOMY AND PHYSIOLOGY OF NOCICEPTION

A. Nociception

Nociception is the sensation of noxious stimuli. It involves detection and quantitation of noxious stimuli (transduction), the processes involved in modifying and conveying that information to the brain (transmission, modulation, and projection), and recognition of the stimulus. Although some authors state that nociception includes perception, most psychologists maintain a distinction between sensation and perception, although unequivocally proving that the difference between the two remains elusive (Chapman, 2005; Chapman et al., 2001). Sensation can be thought of as a discriminative response to physical stimulation of a sensor, nerve, or brain area. Perception is the cognitive and emotive processing of sensation into a subjective experience. Thus, the important distinction between nociception and pain is that nociception includes the neurobiological processes by which noxious stimuli are encoded as neural impulses and sent to the brain where the impulses are decoded into the stimuli's physical properties (hot, cold, sharp, dull) (Chapman and Nakamura, 1999), while pain is the cognitive and emotive interpretation of the sensation as a hurtful or unpleasant experience. It should be noted that these differences account for the fact that pain is not entirely dependent on nociception nor does all encoding of noxious stimuli result in pain. Many investigators believe that animals are only capable of nociception and reserve the concept of "pain" exclusively for human beings. This is based on the notion that we do not actually know what animals "experience" and can only define pain in a species that expresses recognition of the experience. Clearly, though, the behavior and effect on animals in response to noxious stimuli indicate that they do experience pain (Dubner and Ren, 1999).

1. *Transduction*

Transduction is the process of converting noxious thermal, mechanical, or chemical stimuli into an action potential (AP). The transducers are high-threshold, nonselective cation or sodium ion channels gated by chemical ligands, temperature, or mechanical shearing forces. These transducers are located on the distal terminus (nociceptor) of highly specialized primary afferent sensory neurons (C and A δ fibers). When activated, the channels open and inward-flowing ions produce "generator" potentials: small, sub-AP threshold current. When sufficient numbers of transducers are activated, enough current is produced to trigger the opening of voltage-gated sodium channels, initiating an AP (Bevan and Szolcsanyi, 1990). The frequency and duration of the AP is proportional to the intensity and duration of the stimulus. Through their gating and activation, transducers qualitatively detect a stimulus, and quantitate its intensity and duration. Transducer expression profiles also

define the receptive character of nociceptors. Most nociceptors are polymodal; they express various transducers and respond to a wide variety of stimuli. Others are unimodal; they have limited expression patterns and only respond to thermal or mechanical stimuli. Lastly, some nociceptors are referred to as “silent”; they express transducers with such high activation thresholds that they are only activated when sensitized by tissue injury (Millan, 1999; Schmidt et al., 1995).

The major transducer types identified (probably not all) include transient receptor potential ion channels (TRPs), ATP-gated ion channels, and acid-sensing ion channels (ASIC). The TRP family, which includes the capsaicin-sensitive vanilloid receptor, responds to thermal, chemical, and possibly mechanical stimuli [reviewed in Wang and Woolf (2005)]. The ATP-gated ion channels of the P2X family are activated by extracellular ATP, released in response to mechanical forces, inflammation, and nerve damage. Forms of P2X are involved in sensing bladder distension and appear important in mediating neuropathic mechanical allodynia and inflammatory pain [reviewed in Khakh and North (2006)]. ASIC are subunits of the degenerin–epithelial sodium channel group that transduce innocuous mechanical stimuli such as touch, yet to be proven as detectors of noxious mechanical stimuli (Garcia-Anoveros et al., 2001; Price et al., 2000).

2. *Transmission*

Transmission is the process by which primary afferent (PA) sensory neurons (first order) propagate APs to the spinal cord. Nociceptive neurons originate in the dorsal root ganglia (DRG) or trigeminal ganglia, and their axons terminate in the various laminae of the spinal cord dorsal horn (DH). Nociceptive neurons are characterized by size, myelination, peptide content, receptive characteristics, and site of termination in the spinal cord. The principal peripheral nociceptive neurons are comprised of A δ and C-type fibers. A β fibers, also found in the periphery, transmit innocuous mechanical stimuli such as touch and proprioceptive information. In visceral organs, noxious and innocuous stimuli are transmitted by A δ and C-type fibers [reviewed in Millan (1999)]. A δ fibers are thinly myelinated, have intermediate velocities (10–30 m/s), punctate receptive fields, and respond to thermal and mechanical stimuli. C fibers, which constitute the majority of peripheral nociceptive fibers, have small unmyelinated axons, slow conduction velocities (0.5–2 m/s), wide receptive fields, and respond to mechanical, thermal, and chemical stimuli or are polymodal. By contrast, A β fibers are large, myelinated, and have fast conduction velocities (30–100 m/s). A δ neurons propagate with short latency and high intensity, producing sharp, rapid sensation and reflex initiation. C fibers propagate much more slowly, often after A δ activation, and produce a dull, slower onset pain [Handwerker and Kobal, 1993; reviewed in Millan (1999)]. Multiple classes of C and A δ neurons exist, although designations are complicated by inconsistent terminology, tissue and species variation, and

other factors. For good overviews of nociceptor classification, see Giordano (2005), Julius and Basbaum (2001), Millan (1999), and Raja et al. (1999).

All neurons express voltage-gated sodium ion channels (Na $_V$) and, of the nine known forms (Na $_V$ 1.1–1.9), DRG neurons express five (Na $_V$ 1.1, 1.3, 1.7, 1.8, and 1.9) that play critical roles in both acute and chronic pain (Amir et al., 2006; Rush et al., 2007). Based on tetrodotoxin (TTX) susceptibility, Na $_V$ can be subdivided into TTX-sensitive (TTXs) or TTX-resistant (TTXr) forms, and C fibers tend to predominantly express TTXr forms (Raja et al., 1999). The TTXr isoforms Na $_V$ 1.9 and 1.8 are selectively expressed in DRG nociceptive neurons, and TTXs Na $_V$ 1.7 is selectively expressed in nociceptive DRG neurons and sympathetic ganglia (Amaya et al., 2000; Black et al., 1996; Dib-Hajj et al., 2002; Fang et al., 2002). The lack of any Na $_V$ -subtype-specific inhibitors has prevented elucidating the exact role the subtypes play. It appears that Na $_V$ 1.9 current does not contribute substantially to AP generation and has been postulated to amplify generator potentials (Dib-Hajj et al., 2002). Na $_V$ 1.8 contributes substantially to AP electrogenesis (Renganathan et al., 2001) and has specialized functions that appear to modulate nociception (Akopian et al., 1999; Cummins et al., 1999; Patrick Harty and Waxman, 2007). Na $_V$ 1.7 has also been hypothesized to contribute to AP initiation by amplifying generator potentials and increasing excitability by shifting the membrane potential toward the voltage gate of Na $_V$ 1.8 (Cummins et al., 1998; Herzog et al., 2003). Na $_V$ 1.7 is upregulated by inflammation and modulates inflammatory pain (Black et al., 2004a; Nassar et al., 2004). Activating mutations in Na $_V$ 1.7 are responsible for pain in the genetic human neuropathy erythromelalgia and reduce lidocaine sensitivity (Cummins et al., 2004; Sheets et al., 2007), and deactivating mutations in Na $_V$ 1.7 are linked to congenital inability to experience pain (Cox et al., 2006).

3. *Projection*

a. Spinal Cord to Brainstem and Thalamus

Projection starts in the DH and is the process of conveying information through the spinal cord to the brain. The majority of PA nociceptive neurons enter the DH and synapse on projection (second order) neurons originating in the DH gray. PA connect either directly (monosynaptic) or through polysynaptic connections with interneurons, primarily in lamina I, the substantia gelatinosa (II, II $_a$), and lamina V of the dorsal spinal cord (Willis and Coggeshall, 1991). Although neuroanatomical terminology and description varies in the literature, C fibers predominantly innervate laminae II, II $_a$, and V; A δ primarily innervate I, II, and II $_a$; and A β innervate III–VI (Almeida et al., 2004; Millan, 1999). The organization of ascending spinal tracts and response patterns to nociceptive transmission depend on dorsal horn projection neurons (DHPN) which are differentiated by the afferent information they receive and code into nociceptive-specific (NS), wide dynamic range (WDR), and

non-nociceptive (N-NOC) neurons. NS neurons are found in laminae I, II, V, and VI; are innervated by high-threshold A δ , heat, and polymodal C fibers; are somatotopically organized in laminae I; and code localizing and qualitative information about noxious stimuli [Leem et al., 1994; Price et al., 1978; Sorkin et al., 1986; Woolf and Fitzgerald, 1983; reviewed in Almeida et al. (2004) and Dubner and Bennett (1983)]. WDR neurons are innervated by C, A δ , and A β fibers; are found in laminae I, II, IV, V, VI, and X; and function to convey the intensity of noxious and innocuous mechanical, thermal, and chemical stimuli [Leem et al., 1994; Price et al., 1978; Sorkin et al., 1986; Woolf and Fitzgerald, 1983; reviewed in Almeida et al. (2004) and Dubner and Bennett (1983)]. Both NS and WDR neurons contribute to the temporal aspects of pain. N-NOC fibers code innocuous thermal and mechanical information from A β and A δ fibers.

The neuroanatomy and organization of ascending pain projections is quite complex. Axons of NS and WDR neurons are components of seven parallel spinal tracts rising in the anterolateral, dorsolateral, and ventrolateral funiculi [reviewed in Millan (1999)]. These tracts project nociceptive information to numerous brainstem, midbrain, and forebrain areas involved in sensory-discriminative, affective-motivational, autonomic, and endocrine aspects of pain, as well as descending antinociception. The laminar origin and relative contribution of each tract to nociception varies between species and may also be differentially involved in somatic versus visceral pain (Carstens and Trevino, 1978; Giesler et al., 1976; Jones et al., 1987; Klop et al., 2005; Palecek, 2004; Willis et al., 1979). For clarity, the salient features of four tracts that may be the most important will be discussed: the spinothalamic tract (STT), spinoreticular tract (SRT), spinomesencephalic tract (SMT), and spinohypothalamic tract (SHT). It is also worth pointing out that with the exception of the SHT, these tracts are not NS; they are also comprised of N-NOC fibers. [For more detailed information on spinal nociceptive tracts, see Almeida et al. (2004), Millan (1999), and Willis and Coggeshall (1991)].

Most NS and WDR neurons project as components of the STT, still considered the primary route by which nociceptive information reaches the brain in most species. The STT rises for the most part in the ventrolateral funiculus (VLF) and also has components in the dorsolateral funiculus of the spinal cord (Apkarian and Hodge, 1989; Martin et al., 1990). In humans and nonhuman primates, DHPN rise predominantly in the contralateral STT, which is uninterrupted in the spinal cord (De Lahunta, 1977; Kerr, 1975). Domestic animals appear to have a larger percentage of projections entering the ipsilateral tract, and there is indication that the STT has frequent synapses with gray matter neurons that rejoin the originating or contralateral STT. In contrast to humans and nonhuman primates, other animals have a bilateral, diffuse and multisynaptic nociceptive pathway in the spinal cord (De Lahunta, 1977). The neuroanatomy of the STT explains why total anterolateral cordotomy of the VLF would be a less than effective procedure for controlling pain in domestic animals.

Fibers from the STT primarily connect to thalamic nuclei (lateral, medial, and posterior groups), but also innervate the parabrachial nucleus, which is involved in arousal and autonomic responses to pain, and areas of the rostroventral medulla, caudal pons, and midbrain, which are involved with bulbospinal antinociception [reviewed in Almeida et al. (2004) and Millan (1999)]. STT connections to various thalamic nuclei also show considerable variation across species (Boivie, 1979; Craig and Dostrovsky, 1999; Giesler et al., 1981; Mantyh, 1983; Martin et al., 1990; Ralston and Ralston, 1992).

The SRT and SMT are comprised primarily of NS and WDR neurons, the SHT by NS neurons, and all rise in the VLF. SRT neurons synapse in serotonergic raphe nuclei and noradrenergic magnocellular nuclei of the rostroventral medulla and caudal pons, and the SMT to the midbrain periaqueductal gray (PAG) and periventricular gray (PVG) [reviewed in Almeida et al. (2004) and Millan (1999)]. The brainstem and midbrain connections of the SRT and SMT suggest they are important pathways for modulating descending control of nociception and, through projections from target nuclei to the limbic system, appear to function in motivational-affective components of pain (Mancia et al., 1987; Willis, 1991).

The SHT projects directly to the hypothalamus. From there, a substantial portion of the SHT fibers course as part of the supraoptic decussation to reach the ipsilateral hypothalamus, thalamus, basal forebrain, and limbic nuclei (Burstein et al., 1996; Dado et al., 1994b; Kostarczyk et al., 1997; Malick et al., 2000; Zhang et al., 2002). By virtue of their connection and activity, SHT projections are believed to be important in visceral and somatic pain, and autonomic and endocrine responses to pain (Burstein et al., 1990; Dado et al., 1994a; Katter et al., 1991; Palkovits, 1999; Zhang et al., 1999, 2002).

The propriospinal and dorsal columns may also contain nociceptive afferents, the latter being particularly important in projection of visceral pain, especially when visceral inflammation is present (Palecek, 2004). Recently, using transneuronal tracing, it has been shown that the lamina II nonpeptidergic cells project via lamina V to the hypothalamus, amygdala, bed nucleus of the stria terminalis, and the globus pallidus. These centers in the brain are associated with the affective dimension of pain.

b. Thalamus to Cortex

The thalamus has long been considered the key relay for receiving and integrating spinal nociceptive input and projecting that information to cortical and subcortical areas of the brain. As with the organization of the spinal cord, the neuroanatomy of the thalamus and its afferents and efferents is quite extensive. Unfortunately the use of inconsistent and species-specific terminology and absolute or legacy designations, which are derived from less than conclusive studies, is confusing (Willis et al., 2002). Although across species structures described may be analogs not homologs, the terminology generally used for primates will

be employed for clarity, and the salient features will be presented (for more detailed descriptions, see Almeida et al. (2004), Craig and Dostrovsky (1999), Lenz et al. (2004), and Millan (1999)).

Nociceptive afferents (third-order neurons) to cortical and subcortical regions arise from thalamic nuclei in the lateral, medial, and posterior groups. The thalamus is much more than a simple relay station; specific thalamic nuclei have distinct and complementary functional roles integrating nociceptive information for processing into the sensory-discriminative (intensity, duration, quality, location) and affective-cognitive (emotion, perception, recognition, learning, attention, memory retrieval, action) aspects of pain (Craig and Dostrovsky, 1999; Sherman and Guillery, 1996, 2002). Nuclei of the lateral group project principally to the primary and secondary somatosensory cortices, important in sensory-discriminative aspects of pain, and to the prefrontal cortex, an area critical for affective-cognitive function. The ventroposterolateral (VPL) nuclei of this group are often referred to as the primary somatosensory relay. The posterior thalamic nuclei project to the insula and anterior cingulate cortex, brain areas involved in the affective-cognitive dimensions of pain. The medial thalamic nuclei project to the anterior cingulate cortex and areas of the basal ganglia involved in attention and motor control (Craig and Dostrovsky, 1999; Lenz et al., 2004). The cortical structures mentioned also have complex patterns of interconnection (Cavada and Goldman-Rakic, 1989a, 1989b; Neal et al., 1990) and connectivity with the thalamus, hypothalamus, limbic and basal forebrain, including “reverberating” circuits between the thalamus and cortex that augment cortical and thalamic activation by noxious stimuli (Kuroda et al., 2004; Narikashvili, 1976; Nothias et al., 1988), and may be important in central and phantom-limb pain (Canavero, 1994).

4. Modulation

Modulation is the process by which nociceptive information from PA is inhibited or augmented. It occurs primarily in the spinal DH as well as in supraspinal sites. PA nociceptive signals can undergo extensive modulation in the DH by segmental spinal and/or descending mechanisms, which inhibit or facilitate neurotransmission (Sandkuhler, 1996). Teleologically, antinociceptive systems are thought to be a part of the “flight or fight” response and allow escape and making rational judgments after severe injury.

a. Intersegmental Inhibition

Most DH neurons are inhibitory interneurons (IIN), some of which synapse on A and C fibers and their projection neurons. Specific spatial and temporal firing patterns of PA activate IIN, which decreases the excitation of PA and second-order neurons inhibiting nociceptive neurotransmission in the DH (Giordano, 2005; Westlund, 2005).

b. Descending Inhibition

Although pain is modulated at the supraspinal level in the thalamus, cerebral cortex, and other brain areas, descending pathways may be the most important for antinociception (Sandkuhler, 1996; Yoshimura et al., 2004). Descending antinociception was first demonstrated by Reynolds in 1969, who produced surgical analgesia by electrical stimulation of the PAG in rats (Reynolds, 1969). Since then, descending antinociceptive systems and the role of the rostroventral medulla (RVM) and PAG in descending antinociception have been firmly established [reviewed in Sandkuhler (1996)]. Nuclei in the RVM are innervated by the STT and SRT (and possibly other tracts) and send descending projections through the dorsal funiculus that synapse on DH IIN. When activated by nociceptive signals from the STT/SRT, RVM nuclei initiate the activation of DH IIN that inhibit the presynaptic release of neurotransmitters from A and C fibers and reduce the excitability of second-order projection neurons [reviewed in Fields et al. (1991)]. Direct inhibition of PA fibers or inhibition of excitatory interneurons by RVM projections is also possible [reviewed in Fields et al. (1991)].

The PAG influences the DH almost exclusively through serotonergic and noradrenergic nuclei in the pons and RVM. Although often described as simple monosynaptic pathways, the connections between the PAG and pons/RVM are more likely through a polysynaptic pontobulbar network (Odeh and Antal, 2001). The PAG is activated by nociceptive input from spinal, thalamic, and cortical projections, and its antinociceptive functions might be mediated by the same descending pathways and DH mechanisms as the RVM [Yu and Han, 1989; Zhao et al., 2006; reviewed in Cui et al. (1999)]. The PAG is also involved in mediating the antinociceptive effects of endogenous and exogenous opioids through several mechanisms including descending inhibition (Hirakawa et al., 1999; Morgan et al., 1991; Osaki et al., 2003; Vaughan et al., 1997; Vazquez et al., 2005).

c. Facilitation

Although not as well characterized as descending inhibition, facilitation of inflammatory and NP can also occur through the same nuclei responsible for descending inhibition but involving the action of different cell types (Heinricher et al., 1987; Neubert et al., 2004; Vanegas and Schaible, 2004). Facilitation is thought to occur by increased excitation of pre- and postsynaptic nociceptive neurons, which enhances DH nociceptive neurotransmission (Almeida et al., 1996; Morgan and Fields, 1994).

III. NEUROPHARMACOLOGY OF NOCICEPTION

The pharmacology of nociception involves a plethora of neurotransmitters, excitatory and inhibitory amino acids, peptides,

enzymes, signaling molecules, lipids, and their receptors. The following discussion will focus on DH neuropharmacology, the best characterized and of most clinical significance.

A. Excitatory Neurotransmitters and Receptors

The primary excitatory neurotransmitter released by nociceptive terminals is glutamate, which preferentially binds to α -amino-3-hydroxy-5-methyl-4-isoxazolepropionic acid (AMPA), kainate, and *N*-methyl-D-aspartate (NMDA) receptors on postsynaptic membranes of second-order neurons. These receptors are ligand-gated ion channels (AMPA/kainate- Na^+ , K^+ ; NMDA- Na^+ , K^+ , Ca^{++}). AMPA receptor activation produces fast, transient (several milliseconds) excitatory postsynaptic potentials (EPSPs) (Bleakman et al., 2006). NMDA receptors are normally inhibited by a voltage-gated magnesium (Mg^{++}) channel and produce slow sustained (>10 seconds) EPSPs (Petrenko et al., 2003). The role of kainate receptors in nociception is not fully understood [reviewed in Wu et al. (2007)]. Glutamate is released in response to brief- or low-intensity noxious stimuli, usually from A δ fibers, activating AMPA/kainate receptors. Primary afferents also express kainate and AMPA receptors on the presynaptic membrane (autoreceptors), which function in a feedback loop decreasing glutamate release. Fast EPSPs encode onset, duration, intensity, and location of a noxious stimulus, and are responsible for the well-localized, transient, sharp, and stinging/stabbing quality of physiologic pain (Muir and Woolf, 2001; Woolf and Salter, 2000). Nociceptor activation from intense or sustained noxious stimuli (C-fiber intensity) results in the release of greater amounts of glutamate and metabotropic neuromodulators such as substance P (SP). The increased glutamate and SP release initiates activation and recruitment of NMDA receptors, producing a greater, more sustained response. The details and significance of NMDA receptor activation will be addressed in Section VI.B.

B. Inhibitory Neurotransmitters and Receptors

1. GABA and Glycine

The principal inhibitory neurotransmitter in the nervous system, including the spinal DH, is gamma-amino-butyric acid (GABA), with glycine being the next most significant. GABA and glycine are primarily released from DH IIN in response to segmental or descending activation. There also exists a population of nonserotonergic neurons originating in the RVM that likely release GABA and glycine in the DH (Cho and Basbaum, 1991; Kato et al., 2006). GABA's action in the DH is mediated by ionotropic GABA_A (chloride channel) and metabotropic GABA_B (G protein coupled) receptor subtypes present on presynaptic A δ - and C-fibers and postsynaptic projection fibers. GABA_A activation hyperpolarizes the

cell decreasing excitation, and GABA_B activation reduces the release of glutamate, SP, and calcitonin gene related product (CGRP) (Melcangic and Bowery, 1996). GABA modulation of nociception in A δ and C fibers appears to be through GABA_B activation, and in projection neurons by GABA_A activation (Lin et al., 1994, 1996; Maeda et al., 2007; Melcangic and Bowery, 1996). Much less is known about glycine modulation of nociception. Glycine receptors are ligand-gated ion channels distributed mostly in lamina II of the DH on postsynaptic sites (Harvey et al., 2004). The distribution and function of these receptors suggests they modulate nociception by hyperpolarizing second-order neurons, decreasing their excitability (Harvey et al., 2004).

2. Serotonin and Norepinephrine

Serotonin (5-hydroxy-tryptamine, 5-HT) and norepinephrine (NE) are the neurotransmitters most critical to descending antinociception. The antinociceptive actions of 5-HT and NE also appear to be interdependent; depleting one reduces the effects of the other (Fields et al., 1991). Descending antinociceptive fibers arise from serotonergic nuclei in the RVM and adrenergic nuclei in the pons, releasing 5-HT and NE in the DH [reviewed in Fields et al. (1991), and Yoshimura and Furue (2006)].

NE inhibits nociception by activating alpha-1 receptors on IIN, stimulating the release of GABA and glycine, and by reducing the excitation of excitatory interneurons through alpha-2 receptors. NE also binds to alpha-2 receptors on PA presynaptic and second-order postsynaptic membranes, mediating antinociception by reducing the glutamate release from PA and reducing the excitation of projection neurons (Sonohata et al., 2004).

5-HT receptors of various subtypes are expressed on DH interneurons, PA presynaptic, and second-order postsynaptic membranes. The exact subtypes and mechanisms involved in 5-HT-mediated antinociception are not firmly established. Electrophysiological studies suggest that 5-HT modulates nociception in a similar fashion as NE [reviewed in Yoshimura and Furue (2006)].

The neuropharmacology of pain facilitation appears to involve many of the same neurotransmitters as descending inhibition, but is not nearly as well understood. It likely involves the activation of NE and 5-HT receptor subtypes that facilitate excitation (Yoshimura and Furue, 2006).

IV. NEONATAL DEVELOPMENT AND PAIN

Much study has focused on the developmental neurobiology of nociceptive systems in rats and humans but relatively little for other species. Mellor et al. suggest that a fetus is unconscious until birth, the implication being that a fetus does not feel pain, because perception requires consciousness (Mellor and Gregory, 2003; Mellor et al., 2005). Neurologic development at birth varies significantly across species, making conclusions

about neonatal pain processing difficult. For an excellent review of the developmental biology of peripheral and spinal nociception, the reader is referred to Fitzgerald (2005) and the Chapter ‘Anesthesia and Analgesia in the Fetus and Neonate’, later in this book. The reader is also referred to the website <http://www.translatingtime.net/> where there are data correlating the development of the CNS between a number of species.

A. Pain in the Neonate

In neonatal rats, A fibers evoke excitatory synaptic processes normally restricted to C-fiber input in adults, and low-threshold input dominates the newborn DH (Fitzgerald and Jennings, 1999). This is because the innervation of nociceptive-related DH laminae (I and II) in neonatal rats is initially from A fibers, which regress over the first 3 weeks of life concurrent with C fiber in-growth and development of physiologic activity (Baccei and Fitzgerald, 2005; Beggs et al., 2002; Fitzgerald and Gibson, 1984; Jennings and Fitzgerald, 1998). In atricial rats, intersegmental reflexes are hyperresponsive, reflexive thresholds for noxious stimuli are much lower than in adults, and both noxious and non-noxious stimuli elicit the same type of unlocalized whole body responses (Fitzgerald, 2005). As the nervous system develops, responses become more localized and discriminating between noxious and non-noxious stimuli. In rats, descending inhibitory systems that help fine-tune responses are immature at birth and do not appear to be functional until 3 weeks after birth (Boucher et al., 1998; van Praag and Frenk, 1991).

B. Developmental Effects of Pain

The concept of neonatal pain has led to active research on the long-term effects of exposing neonates to noxious stimuli. Studies in rat and mouse have demonstrated that exposing neonates to noxious stimuli results in altered behavior and nociception in adulthood (Anand et al., 1999; Anseloni et al., 2005; Bhutta et al., 2001). The type of noxious stimuli applied to a neonate and the stage of development at which it is applied influence the outcome in adulthood. Neonates exposed to noxious agents may have increased or decreased sensitivity to noxious stimuli in adulthood, depending upon the type and duration of the stimulus (Hohmann et al., 2005; Lin and Al-Chaer, 2003; Randich et al., 2006; Ruda et al., 2000; Shimada et al., 1990; Sternberg et al., 2005; Wang et al., 2004). It is likely that the extremely plastic nature of the neonatal nervous system is responsible for these effects (Nothias et al., 1988; Ren et al., 2005a; Ruda et al., 2000; Saab et al., 2004; Walker et al., 2003).

V. PHYSIOLOGIC EFFECTS OF PAIN

In addition to the ethical considerations for relieving pain, the physiologic consequences of untreated or undertreated pain

may significantly impact animal health and bias research results. Pain has significant effects on the cardiovascular, pulmonary, endocrine, and autonomic nervous systems that contribute to increased morbidity and mortality (Kehlet, 1988, 1989; Yeager et al., 1987). The effects of pain may be clinical, as in an animal that fails to groom, loses body condition, or exhibits autotomy, or subclinical, and only manifests after a research manipulation, e.g., enhanced tumor promotion in response to surgical pain (Bar-Yosef et al., 2001; Page, 2003). Pain initiates integrated neuroendocrine and autonomic nervous system responses which may represent a feedback mechanism for limiting inflammation (Miao and Levine, 1999), as well as mechanisms for maintaining homeostasis. The physiologic effects of these responses may start out as beneficial and adaptive, but become pathologic if activated for prolonged periods or if dysregulated. Counter to Selye’s stress theory of a generalized response to any perturbation of homeostasis, specific stressors elicit a characteristic neuroendocrine and autonomic “signature”; thus, responses to pain are not the mirror image of those elicited by restraint or other stressors (Pacak and Palkovits, 2001; Pacak et al., 1995; Pan et al., 1997), and visceral pain may not evoke the same response as somatic (Mineta et al., 2004).

The primary system affecting the neuroendocrine response to pain is the hypothalamic–pituitary–adrenal axis (HPA), with hypothalamic–pituitary control of other endocrine glands, fluid and electrolyte balance and appetite contributing as well. The best-characterized physiologic responses to pain arise from the activation of the sympathetic nervous system (SNS). The neuroendocrine and SNS responses to pain are initiated by neuronal stimulation through direct (Almeida et al., 2004; Millan, 1999; Palkovits et al., 1999) or indirect connection with nociceptive pathways (Van de Kar and Blair, 1999), or by interleukin-1 (IL-1) or tumor necrosis factor (TNF) released from inflammation (Besedovsky and del Rey, 1996; DeKeyser et al., 2000).

A. Neuroendocrine Response

Acute pain activates the HPA axis resulting in the release of corticotrophin-releasing hormone (CRH) from the hypothalamus, antidiuretic hormone (ADH), prolactin, adrenocorticotrophic hormone (ACTH), and β -endorphin from the pituitary, and glucocorticoids from the adrenal glands (Aloisi et al., 1995; Bodnar et al., 2006; Culman et al., 1997; Mellor et al., 2002; Pacak et al., 1995). From the known effects of glucocorticoids and β -endorphin, it is reasonable to assume that pain could be immunosuppressant. Although often stated as fact, the best evidence that pain is immunosuppressive is indirect and comes from models and studies of surgical stress and trauma, mostly in humans. A pain component likely contributes to known immunologic effects of surgical stress: reduced neuropeptide Y cell activity, depressed cell-mediated immunity and lymphocyte proliferation, altered T-cell ratios, and production

of proinflammatory cytokines [Beilin et al., 2003a, 2003b; Toge et al., 1981; reviewed in Page (2003)].

Pain may also play a role in tumor growth. Several studies, mostly in rodents, have established that controlling pain reduces experimentally induced tumor burden (Page et al., 1993, 2001), and that the effect is centrally mediated (Bar-Yosef et al., 2001). This concept is supported by preliminary data from human breast cancer patients in which paravertebral analgesia was associated with lower rates of cancer recurrence at 24 and 36 months (Exadaktylos et al., 2006).

B. Cardiovascular Effects

Pain-induced activation of the SNS increases plasma catecholamines and has well-documented cardiovascular effects including increases in heart rate, blood pressure, cardiac output, and systemic vascular resistance (Brand et al., 1995; Culman et al., 1997; Hoar et al., 1976; Sjogren and Wright, 1972; Wang et al., 2005). Pain has also been shown to increase SNS-mediated myocardial oxygen demand, coronary arterial vasoconstriction, and fetal/neonatal pulmonary vasoconstriction (Debarge et al., 2007; Klassen et al., 1980; Vik-Mo et al., 1978). It is also likely that activation of the SNS increases the circulating levels of angiotensin II and aldosterone, which, in concert with ADH, increases retention of sodium and water (Cousins and Power, 1999).

C. Pulmonary Compromise

Pronounced pain can significantly compromise pulmonary function through SNS activation, reductions in chest excursion and coughing, and possibly diaphragmatic dysfunction. In studies of human thoracic surgery patients, pain has been shown to decrease tidal volume, functional residual capacity, and minute ventilation, and cause ventilation–perfusion mismatch, resulting in hypoxemia and hypercarbia (Erdogan et al., 2005; Lewis et al., 1994; Rawal, 2001; Roediger et al., 2006; Solak et al., 2007). Pain is also associated with an increased prevalence of pneumonia in postoperative patients (Cousins and Power, 1999; Lewis et al., 1994). Although not well investigated, pain probably elicits similar pulmonary effects in animals (Dhokarikar et al., 1996; Flecknell et al., 1991; Vesal et al., 1996).

D. Miscellaneous Effects

Other metabolic and physiologic effects attributed to pain include glucose intolerance, ileus, induction of a “catabolic state,” decreased reproductive function, and sleep disturbance (Cousins and Power, 1999).

VI. NEUROPLASTICITY AND PAIN: PERIPHERAL AND CENTRAL SENSITIZATION

In response to stimulation or activity, neurons can alter their structure and/or function, a process referred to as neural plasticity. In nociceptive neurons, neuroplastic changes can increase the responsiveness of primary afferents (peripheral sensitization) and amplify and facilitate synaptic activity in the spinal DH or spinal nucleus of the trigeminal (CS, central sensitization). Since peripheral and central sensitization underlie the development and maintenance of pain as disease, understanding and controlling its initiation is a cornerstone of appropriate pain management.

A. Peripheral Sensitization

Nociceptors express a constellation of receptors for biochemicals released by inflammatory cells or injured/inflamed tissue, which produce pain (algogens) and/or increase nociceptor responsiveness and excitability (sensitization). The principal inflammatory products (which may be synergistic) and their action are listed in Table 1-1. The initial mechanism by which these chemicals sensitize nociceptors is receptor-mediated activation of protein kinase A or C, which phosphorylate transducers, receptors, and TTXr Na_v, reducing their activation thresholds (McCleskey and Gold, 1999; Numazaki et al., 2002; Obreja et al., 2005). Transducer phosphorylation increases nociceptor responsiveness to stimuli (hypersensitivity and primary allodynia), and likely increases the number of APs delivered to the DH by activating silent nociceptors [reviewed in Milan (1999), Woolf and Salter (2000)]. The phosphorylation of TTXr Na_v causes greater neuronal excitability, which increases the AP frequency initiated by stimuli (primary hyperalgesia) [Gold et al., 1998; reviewed in Julius and Basbaum (2001)]. The process is further amplified by nociceptor release of SP, CGRP, and excitatory amino acids (EAA) that act on neighboring neurons, vasculature, and immune cells, and form a positive feedback loop on the initiating nociceptor. These neuronally

TABLE 1-1
PRINCIPLE INFLAMMATORY PRODUCTS RESPONSIBLE FOR PERIPHERAL SENSITIZATION

Inflammatory mediator	Action
Bradykinin	Algogen/sensitization
Prostagandin E ₂	Sensitization
Histamine	Sensitization
Serotonin	Algogen/sensitization
Hydrogen ions	Algogen/sensitization
ATP	Algogen/sensitization
Nerve growth factor	Sensitization

Note: Order in chart does not denote significance.

derived chemicals may activate or sensitize adjacent nociceptors directly or indirectly, cause “neurogenic inflammation” (vasodilatation, increased vascular permeability), and initiate or amplify inflammatory cell responses [Lin et al., 2000; Szolcsanyi, 1988; reviewed in Willis (1999)]. Changes in gene transcription and translation further help in perpetuating the cycle. Neurotrophic factors and cytokines released by inflammatory cells or inflamed tissue initiate PA upregulation of Na_V , TRPs, SP, and other peptides and proteins involved in sensitization (Black et al., 2004a; Lai et al., 2004; Mamet et al., 2002, 2003; Michael and Priestley, 1999; Sachs et al., 2002; Tate et al., 1998; Woolf, 1996). Through the aforementioned mechanisms, peripheral sensitization contributes to clinical pain and the initiation of CS (Muir and Woolf, 2001; Woolf, 2004).

B. Central Sensitization

1. *Wind-up*

Throughout the literature on pain, the term “wind-up” is often cited as a mechanism for rapid acute pain augmentation and a predecessor to CS. In actuality, “wind-up” is a progressive increase in AP frequency generated by closely repeated constant pulses of electricity (Mendell and Wall, 1965). It is an experimental electrophysiologic demonstration of neural plasticity and occurs within seconds of stimulation. Wind-up is neither necessary nor sufficient for CS to occur and, though it has perceptual correlates in people and animals and is quite dependent on NMDA receptor activity, its physiologic significance and role in pain is uncertain (Davies and Lodge, 1987; Dickenson and Sullivan, 1987; Herrero et al., 2000; Price et al., 1977; Sarkar et al., 2006; Woolf and Thompson, 1991). It has been proposed that “wind-up like” events may facilitate the development of pathologic pain by contributing to the initiation of long-term potentiation (discussed in Section VII.A.2) in C-fiber synapses (Herrero et al., 2000; Sandkuhler, 2000; Sivilotti et al., 1993).

2. *Activity-dependent Neuronal Model*

CS contributes to primary hyperalgesia, and is the only mechanism by which secondary hyperalgesia and secondary allodynia occur (Woolf and Salter, 2000). It is initiated by activity (nociceptive transmission)-dependent posttranslational modulation of neuronal function, and maintained by changes in gene transcription and translation (Woolf and Salter, 2000).

The acute phase of CS depends on the activation of intracellular signaling cascades and protein kinases initiated within minutes of a barrage of C-fiber transmission (Woolf and Costigan, 1999). The “barrage” can occur through three basic mechanisms: an intense stimulus such as traumatic injury or a surgical incision, stimulation of sensitized peripheral nociceptors, or spontaneous activity from injured sensory neurons. As previously described in Section III.A, nociceptor activation from intense or sustained noxious stimuli results in transmission of

high-frequency AP trains to the DH and the release of large amounts of glutamate and metabotropic neuromodulators, such as SP, brain-derived neurotrophic factor (BDNF), and others with less well-characterized actions (CGRP and neurokinin A) (Duggan et al., 1990, 1995; Hope et al., 1990; Woolf and Salter, 2000). SP binds to receptors that mediate increased intracellular Ca^{++} levels and opening of voltage-gated Ca^{++} channels that (like NMDA receptors) produce slow sustained EPSPs. Increased glutamate release intensifies AMPA-mediated postsynaptic depolarization, generating sufficient current to recruit NMDA receptors by releasing their Mg^{++} blockade and initiating their activation (Petrenko et al., 2003). Activation of metabotropic glutamate receptors and specific receptors for BDNF and SP appear to increase postsynaptic neuron excitability by triggering a host of interrelated signaling cascades and protein kinases, many of which may be regulated by the mitogen-activated protein kinase (MAPK) cascade [reviewed in Ji and Woolf (2001), Pezet et al. (2002), and Woolf and Costigan (1999)]. Activation of these pathways results in increased intracellular calcium and related signaling and phosphorylation of AMPA and NMDA receptors. Increased intracellular calcium also activates nitric oxide (NO) synthase and production of NO, and activates phospholipase A_2 and cyclooxygenase-2 (COX-2), leading to prostaglandin (PG) formation [reviewed in Yaksh et al. (1999)]. NO and PG appear to facilitate CS through increasing presynaptic SP and increasing postsynaptic membrane excitability (Hingtgen and Vasko, 1994; Malmberg and Yaksh, 1993; Yaksh et al., 1999).

Although it is probable that other proteins contributing to CS are modulated by phosphorylation, AMPA and NMDA are the best characterized. Phosphorylation increases the trafficking of AMPA to the cell membrane, may reduce the voltage gating of NMDA Mg^{++} blockade, and increases the ion conductance of both receptors (Chen and Huang, 1992; Hayashi and Haganir, 2004; Song and Haganir, 2002; Wang and Salter, 1994; Yu and Salter, 1998, 1999; Yu et al., 1997). The net effect of these changes is increased responsiveness of second-order DH neurons to synaptic glutamate release, which amplifies A δ - and C-fiber transmission (hyperalgesia) and allows A β transmission to activate nociceptive projections (mechanical allodynia). Another effect is the expansion of DH receptive fields to include areas outside the primary zone of injury, accounting for the secondary mechanical allodynia and secondary hyperalgesia that characterizes CS (Woolf and King, 1990).

3. *Activity-dependent Glial Model*

An important advance in neurobiology has been the discovery that many aspects of pain, in particular CS, are not completely neuronal events, and may depend upon glial cell (microglia and astrocytes) activation. Glial cells surround every synapse in the central nervous system and, superimposed on the aforementioned classic neuronal model of CS initiation, is

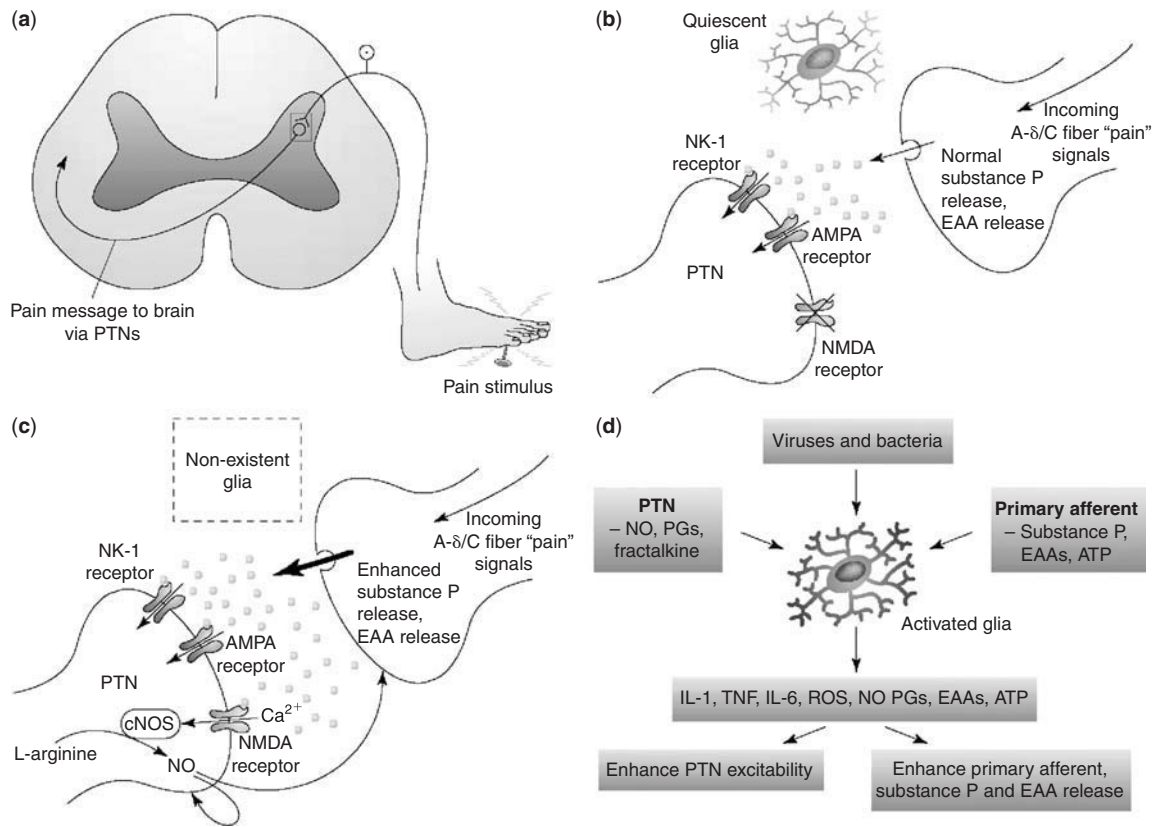

Fig. 1-1 Schematic of central sensitization (CS). Neuronal model of (a) pain signaling and (c) CS. (b) Glial model: Quiescent gliosis during physiologic pain. (d) Role of glial activation in initiating and maintaining CS superimposed on neuronal-driven model. PTN, projection neuron; EAAs, excitatory amino acids; ROS, reactive oxygen species; cNOS, nitric oxide synthase; NK-1, neurokinin-1, the receptor for SP. Not all events involved in neuronal models (a, b, c) are depicted. See text for other abbreviations and description of events. Reprinted from Watkins et al. (2001) with permission from Elsevier.

the proposed role of microglia depicted in Figure 1-1. In the glial model, intense C-fiber activity related SP and glutamate release (described in Section VI.A.2) activates DH microglial cells [reviewed in DeLeo and Yeziarski (2001), Watkins and Maier (2005), and Wieseler-Frank et al. (2005b)]. Microglial cells are also activated by ATP, NO, PG, and fractalkine, a chemokine which may be released by DH neurons under similar conditions (Inoue, 2006; Owolabi and Saab, 2006). Microglial cells alone (not neurons or astrocytes) express fractalkine receptors, lending further support to this model (Watkins et al., 2001). When activated, microglia release a host of substances (Fig. 1-1) known to enhance SP and glutamate release from first-order fiber terminals, increase the excitability of second-order neurons, and activate astrocytes (DeLeo and Yeziarski, 2001; Inoue, 2006; Wieseler-Frank et al., 2005a). The role of astrocyte activation will be discussed in Section VII.A.2.

A significant aspect of this model is that microglia can be activated by viruses, bacteria, or proinflammatory cytokines produced anywhere in the body by any means, explaining pain and hyperalgesia in the absence of injury or during illness [Milligan et al., 2003; Watkins et al., 1994; reviewed in Watkins and Maier (2005)]. Abundant experimental evidence supports

the contention that glial activation is necessary and sufficient for initiating and maintaining CS [Ledeboer et al., 2005; Zhuang et al., 2005; reviewed in DeLeo et al. (2004) and Watkins et al. (2001)]. The glial model suggests that central nervous system synapses have a tetrapartite structure, comprised of microglia, astrocytes, and the pre- and postsynaptic neurons (DeLeo et al., 2006).

4. Transcription/translation Dependent

Over a period of hours to days, CS switches from activity-dependent processes to transcription- and translation-dependent processes. The intracellular signaling pathways triggered in the acute phase of CS likely converge to activate the cAMP-responsive element-binding protein (CREB), which regulates the transcription of numerous genes (Ji et al., 2003). This includes upregulation of COX-2 and concomitant production of PG within hours (Beiche et al., 1996; Hay et al., 1997; Samad et al., 2001), and upregulation of receptors for SP and BDNF [neurokinin-1 (NK-1) and tyrosine kinase B (trkB), respectively] over 24 hours or more (Ji et al., 2002; Mannon et al., 1999). These changes, the activation of astrocytes,

and other events to be discussed allow for the maintenance of CS independent of an afferent barrage, and appear to play an important role in the development of chronic pain (Cervero and Laird, 1996).

VII. PATHOPHYSIOLOGY OF CHRONIC PAIN

Unlike physiologic pain, chronic pain is maladaptive and serves no known purpose. In animals, chronic pain likely arises from injury or inflammation-initiated cascades of neurobiological, immune, and endocrine processes that cause functional and morphologic changes in the nervous system. The physiologic consequences of these modifications modulate and/or uncouple pain from noxious stimuli, or dissociate pain from healing (Cervero and Laird, 1996). Although how and when the transition from acute to chronic pain occurs is unclear, the initiation and maintenance of long-term pathologic alterations in neuronal function, characteristic of chronic pain, undoubtedly involves neuroplasticity in the form of genotypic, phenotypic, and functional changes across the nervous system, some of which may be irreversible.

A. Role of Neuroplasticity and Sensitization

Chronic pain models have demonstrated altered gene and protein expression of a dizzying array of ion channels, receptors, peptides, lipids, enzymes, growth factors, and intracellular signaling molecules, some with distinct temporal and etiologic signatures (Kunz et al., 2005; Shi et al., 2000; Urch et al., 2003; Wang et al., 2002; Waxman et al., 2000; Wiesenfeld-Hallin and Xu, 2001; Woolf and Costigan, 1999; Woolf and Salter, 2000; Zhuang et al., 2005). Also demonstrated in chronic pain paradigms are phenotypic switching in peripheral, DH, and brainstem neurons; topographic and somatotopic neuronal reorganization; death of IIN in the DH; and astrocyte activation (Chung et al., 1996; Hu et al., 2004; Ramer and Bisby, 1998; Ueda, 2006; Yen et al., 2006; Yoshimura et al., 2004). Together, these processes give rise to and maintain the cardinal signs of chronic pain: allodynia, hyperalgesia, and spontaneous pain. Both peripheral and central sensitization appear critical in the genesis of chronic pain. As should be apparent from the description of peripheral and central sensitization, this is a dynamic process; mechanisms giving rise to sensitization-related clinical signs transition over time and differ in acute and chronic pain.

Salient features of these processes that relate to clinical signs and treatment of chronic pain will be discussed later. For detailed information on the pathophysiology of chronic pain, the reader is referred to some excellent reviews (Cervero and Laird, 1996; DeLeo and Yezierski, 2001; Ji and Woolf, 2001; Millan, 1999; Sandkuhler, 2007; Ueda, 2006; Watkins and Maier, 2002; Waxman et al., 2000; Wieseler-Frank et al., 2004).

1. Long-term Potentiation

Many of the signaling cascades involved in the acute phase of CS converge on MAPK-dependent pathways that mediate late-onset transcription-dependent CS (Ji and Woolf, 2001; Zhuang et al., 2005). This includes induction of the extracellular signal-regulated kinase–CREB (ERK–CREB) pathway. ERK–CREB induction in nociceptive pathways bears striking similarity to MAPK-pathway induction responsible for hippocampal long-term potentiation (LTP) (Ji et al., 2003). LTP is an activity-dependent increase in synaptic strength or efficiency that can last for hours to years. Physiologically, this translates into a larger postsynaptic output from a constant level of presynaptic stimulation and is generally believed to be a synaptic substrate for memory and learning (Sandkuhler, 2000). LTP in spinal nociceptive systems has been proposed as a mechanism by which acute pain may become chronic (Ikeda et al., 2006; Rygh et al., 2005; Sandkuhler and Liu, 1998; Suzuki et al., 2005). Therefore, MAPK-dependent pathways represent a novel target for the development of new therapeutic strategies for pain management (Ji and Woolf, 2001).

2. Glial Activation

Injury or inflammation initiates immune–neuronal processes that appear to influence the development of chronic pain. As described in Section VI.B.3, activated microglia in turn activate astrocytes, which may play a role in maintaining chronic pain by releasing cytokines and signaling molecules, perpetuating CS (DeLeo et al., 2004; Narita et al., 2006; Raghavendra et al., 2004). Astrocyte activation occurs about 4 days after microglia are activated (Raghavendra et al., 2004), and brain astrocytes can activate in response to peripheral nerve injury without prior microglial differentiation (Kuzumaki et al., 2007). Preventing microglial activation or blocking the action of their products (prior to astrocyte activation) inhibits the development of hyperalgesia and allodynia (Ledeboer et al., 2005; Mika et al., 2007; Milligan et al., 2005; Raghavendra et al., 2003). However, once astrocytes are activated, inhibiting microglial cells has no effect on pain (Ledeboer et al., 2005; Owolabi and Saab, 2006; Raghavendra et al., 2003). Finally, the nonspecific glial modulator, propentofylline, has been shown to reverse existing nerve-injury-induced mechanical allodynia 14 days after its development (Tawfik et al., 2007). Taken together, these lines of evidence support the pivotal role of glial cells in the pathogenesis of acute and chronic pain.

3. Voltage-gated Sodium Channels

Nav ion channels (Nav 1.3, 1.7, 1.8) have been implicated in the pathogenesis of both neuropathic and inflammatory chronic pain [Lai et al., 2002; reviewed in Lai et al. (2004) and Waxman and Hains (2006)]. In response to injury and inflammation, altered expression and distribution of sodium ion channels

occur in nociceptive afferents and DH neurons (Black et al., 2004b; Devor et al., 1989; Gold et al., 2003; Hains et al., 2004; Tanaka et al., 1998). These changes increase membrane excitability, which augments nociceptor and DH responsiveness and leads to the generation of spontaneous (ectopic) impulses in the absence of stimuli (Chu et al., 2004; Djouhri et al., 2006; Hains et al., 2003, 2006; Lampert et al., 2006; Liu et al., 2002; Pertovaara et al., 2001; Sotgiu and Biella, 2000). Ectopic activity appears to be another significant factor in the initiation and development of chronic pain, and may contribute to allodynia, hyperalgesia, and spontaneous pain (Abdulla and Smith, 2001; Liu et al., 2000; Nakamura and Atsuta, 2004; Pitcher and Henry, 2000). Na_V channel blockade inhibits peripheral nerve-injury-induced spontaneous activity in A and C fibers and the development of NP (Araujo et al., 2003; Smith et al., 2002). However, the temporal relationship between injury, activity blockade, and the development of pain is critical. To abolish the development of allodynia and hyperalgesia, nerve blockade must be initiated within the first 10 days after injury and applied for—three to five consecutive days (Xie et al., 2005).

The expression of Na_V 1.3, 1.7, and 1.8 in DRG neurons is increased in inflammatory chronic pain models (Black et al., 2004a; Tanaka et al., 1998). In contrast, Na_V 1.8 is downregulated in mechanically injured neurons (Decosterd et al., 2002; Dib-Hajj et al., 2002), but redistributed in neighboring uninjured neurons (Gold et al., 2003). Peripheral nerve injury also produces a novel expression of Na_V 1.3 in peripheral nociceptive and second-order DH neurons, and spinal cord injury increases Na_V 1.3 in second-order DH neurons and likely increases it in VPL thalamic neurons (Hains et al., 2004, 2006). Induced changes in Na_V expression are important in the pathogenesis of acute and chronic pain; thus, the development of subtype-specific Na channel blocking agents could provide more specific treatment for inflammatory and NP.

4. Voltage-gated Calcium Channels

Voltage-gated N-type calcium channels are almost exclusively neuronal, densely expressed in laminae I and II of the DH, concentrated at presynaptic terminals, and appear to regulate neurotransmitter release (Westenbroek et al., 1992; Zamponi, 2003). Several studies demonstrate the role of N-type calcium channels in nociception and the development of chronic pain. Inflammation and peripheral nerve injury induce upregulation of the $\alpha 1\beta$ and $\alpha 2\beta$ subunits of N-type calcium channels, which may contribute to peripheral and central sensitization (Abe et al., 2002; Cizkova et al., 2002; Luo et al., 2001; Newton et al., 2001; Yokoyama et al., 2003). In neuropathic and inflammatory models, pharmacologic blockade or targeted deletion of the $\alpha 1\beta$ subunit suppresses the development of allodynia and hyperalgesia [reviewed in McGivern (2006)]. An important step in pain management is the recent development of novel drugs targeting N-type calcium channels. This includes synthetic ω -conotoxins,

developed from toxins produced by marine cone snails, which have been approved or are in clinical trials for treating severe chronic pain (McGivern, 2006).

5. Inhibitory Interneuron Apoptosis

Mechanical nerve-injury-induced ectopic activity leads to apoptosis of cells in the superficial laminae of the DH, including GABAergic IIN (Moore et al., 2002; Whiteside and Munglani, 2001). Loss of these cells appears to be triggered by glutamatergic neurotransmission and mediated by metabotropic glutamate receptor 5 (mGlu5) (de Novellis et al., 2004) and neuronal intercellular caspase-3 activity (Scholz et al., 2005). Nerve-injury-induced apoptosis in the DH exhibits slow onset, persists for weeks, and results in substantial neuronal loss (Scholz et al., 2005). Although not well characterized, the possibility exists that inflammation induces apoptosis in spinal neurons as well (Hassanzadeh and Ahmadiani, 2006). The loss of GABAergic IIN is believed to dissociate the DH from descending antinociceptive signals and further increase CS (Moore et al., 2002; Whiteside and Munglani, 2001). Apoptosis of GABAergic IIN accounts in part for the efficacy of GABA agonists in treating NP, and the mechanism suggests that mGlu5 and caspase-3 may be novel therapeutic targets.

6. Phenotypic Switching

Phenotypic switching is the induced expression of nociceptive-related ion channels, molecules, and receptors not normally found in non-nociceptive sensory neurons, and novel up- or downregulation of similar molecules in nociceptive neurons [reviewed in Malcangio et al. (2000), Ueda (2006), and Zhou et al. (1999)]. In the periphery, this may result in a loss of input from C fibers and novel nociceptive input from A fibers to second-order DH neurons. This form of phenotype switching is noted in nerve injury models and would account for allodynia and CS in the absence of C-fiber input (Neumann et al., 1996; Ueda, 2006). Phenotype switching has been proposed as a mechanism for sympathetic nervous system modulation of chronic pain conditions (Chen et al., 1996; Drummond et al., 1996; Ren et al., 2005b; Treede, 1998) and may also account for the differential effect of some analgesic drugs. For example, the analgesic effects of capsaicin cream in NP may be due to desensitization of de novo vanilloid receptor 1 expressed on fibers that are normally capsaicin-insensitive (Rashid et al., 2003a, 2003b). Although a definitive role has not been ascribed, the diversity of changes noted in a variety of induced chronic pain models supports the role of phenotypic switching in the pathogenesis of chronic pain.

7. Supraspinal Contributions

Although recognized, investigation of supraspinal neurobiology contributing to chronic pain lags far behind what is known

about peripheral nerves and the spinal DH. Supraspinal changes, including somatotopic reorganization, glial activation, altered cortical and subcortical activation, changes in neurotransmitter release and receptor expression, and induction of COX-2, have been suggested to play roles in the pathobiology of chronic pain (Casey et al., 2003; Hagelberg et al., 2004; Hansson and Ronnback, 2004; Karl et al., 2001, 2004; Laemmle et al., 2003; Morrow et al., 2000; Neto et al., 1999; Nystedt et al., 2004; Raghavendra et al., 2004; Samad et al., 2001; Tanga et al., 2004).

8. Psychosocial Factors

The development of chronic pain in people is strongly dependent on psychosocial factors, some of which arise from the cognitive and emotional responses to pain (Koleck et al., 2006; Manchikanti et al., 2002). This lends support to the concept that pain involves interaction between nociceptive, antinociceptive, cognitive, and emotive systems. It also suggests that functional disorder within these intertwined networks may be the physiologic substrate for the development of chronic pain and comorbid conditions (Apkarian et al., 2005; Ashkinazi and Vershinina, 2000; Curatolo et al., 2004; Sud et al., 2006). How, or even if, cognitive and emotive factors influence the development of chronic pain in animals is unknown.

B. Etiologies

Most chronic pain encountered in veterinary medicine is likely neuropathic, inflammatory, or neoplastic in origin. These categories are by no means mutually exclusive, and often overlap or form a continuum. The following section discusses neuropathic, inflammatory, and neoplastic etiologies for chronic pain.

1. Neuropathic Pain

NP is defined by the IASP as “pain initiated or caused by a primary lesion or dysfunction of the nervous system” (Merskey and Bogduk, 1994). An alternative has been proposed, defining NP as “pain caused by a lesion of the peripheral (PNS) or central nervous system (or both) manifesting with sensory symptoms and signs” (Backonja, 2003). Both have strengths and weaknesses, and neither is universally accepted by scientists or clinicians (Bennett, 2003). Numerous experimental studies in animals demonstrate that disease or injury involving nociceptive components of the PNS and/or CNS gives rise to allodynia, hyperalgesia, and/or spontaneous behaviors assumed to be correlates of NP. Although recognized in veterinary medicine, clinical descriptions of NP are limited (O’Hagan, 2006). Etiologies responsible for NP include traumatic, toxic (chemotherapy-induced polyneuropathy), metabolic (diabetes), infectious (herpes virus), neurodegenerative, and inflammatory (multiple sclerosis) diseases. For a complete list, see Dworkin et al. (2003). The examples in parentheses have not necessarily been noted in veterinary medicine.

2. Chronic Inflammatory Pain

Chronic inflammatory pain (CIP) develops from chemicals (algogens, sensitizers, immunomodulators) released by immunocytes infiltrating injured or diseased tissue, and generally refers to somatic or visceral inflammatory pain. With CIP, the underlying disease process often causes long-term production of algogens and sensitizers, which may contribute to the unique neurochemical signatures noted in models of inflammatory pain (Honore et al., 2000). Osteoarthritis, endometriosis, feline lower urinary tract disease, hoof rot, and possibly ulcerative dermatitis are examples of diseases associated with CIP.

3. Cancer-associated Chronic Pain

Although neoplasia is an established cause, its place as an etiology for chronic pain in laboratory animal medicine is somewhat uncertain. Virtually all in vivo tumorigenicity studies are done in rodents, many of which carry significant tumor burdens without showing overt signs of pain. This seems particularly true for immunocompromised mice used to propagate tumor lines. With the exception of bone and neuropathic studies (almost all of which are acute), little is known about pain in animal cancer models or pain associated with spontaneous tumors (other than bone) in animals (Mantyh and Hunt, 2004; Peters et al., 2005; Roughan et al., 2004).

REFERENCES

- Abdulla, F.A., and Smith, P.A. (2001). Axotomy- and autotomy-induced changes in the excitability of rat dorsal root ganglion neurons. *J. Neurophysiol.* **85**, 630–643.
- Abe, M., Kurihara, T., Han, W., Shinomiya, K., and Tanabe, T. (2002). Changes in expression of voltage-dependent ion channel subunits in dorsal root ganglia of rats with radicular injury and pain. *Spine* **27**, 1517–1524; discussion 1525.
- Akopian, A.N., Souslova, V., England, S., Okuse, K., Ogata, N., Ure, J., Smith, A., Kerr, B.J., McMahon, S.B., Boyce, S., Hill, R., Stanfa, L.C., Dickenson, A.H., and Wood, J.N. (1999). The tetrodotoxin-resistant sodium channel SNS has a specialized function in pain pathways. *Nat. Neurosci.* **2**, 541–548.
- Almeida, A., Tjolsen, A., Lima, D., Coimbra, A., and Hole, K. (1996). The medullary dorsal reticular nucleus facilitates acute nociception in the rat. *Brain Res. Bull.* **39**, 7–15.
- Almeida, T.F., Roizenblatt, S., and Tufik, S. (2004). Afferent pain pathways: A neuroanatomical review. *Brain Res.* **1000**, 40–56.
- Aloisi, A.M., Albonetti, M.E., Muscettola, M., Facchinetti, F., Tanganelli, C., and Carli, G. (1995). Effects of formalin-induced pain on ACTH, beta-endorphin, corticosterone and interleukin-6 plasma levels in rats. *Neuroendocrinology* **62**, 13–18.
- Amaya, F., Decosterd, I., Samad, T.A., Plumpton, C., Tate, S., Mannion, R.J., Costigan, M., and Woolf, C.J. (2000). Diversity of expression of the sensory neuron-specific TTX-resistant voltage-gated sodium ion channels SNS and SNS2. *Mol. Cell Neurosci.* **15**, 331–342.
- Amir, R., Argoff, C.E., Bennett, G.J., Cummins, T.R., Durieux, M.E., Gerner, P., Gold, M.S., Porreca, F., and Strichartz, G.R. (2006). The role of sodium channels in chronic inflammatory and neuropathic pain. *J. Pain* **7**, S1–S29.
- Anand, K.J., Coskun, V., Thirivikraman, K.V., Nemeroff, C.B., and Plotsky, P.M. (1999). Long-term behavioral effects of repetitive pain in neonatal rat pups. *Physiol. Behav.* **66**, 627–637.

- Anseloni, V.C., He, F., Novikova, S.I., Turnbach Robbins, M., Lidow, I.A., Ennis, M., and Lidow, M.S. (2005). Alterations in stress-associated behaviors and neurochemical markers in adult rats after neonatal short-lasting local inflammatory insult. *Neuroscience* **131**, 635–645.
- Apkarian, A.V., Bushnell, M.C., Treede, R.D., and Zubieta, J.K. (2005). Human brain mechanisms of pain perception and regulation in health and disease. *Eur. J. Pain* **9**, 463–484.
- Apkarian, A.V., and Hodge, C.J. (1989). A dorsolateral spinothalamic tract in macaque monkey. *Pain* **37**, 323–333.
- Araujo, M.C., Sinnott, C.J., and Strichartz, G.R. (2003). Multiple phases of relief from experimental mechanical allodynia by systemic lidocaine: Responses to early and late infusions. *Pain* **103**, 21–29.
- Ashkinazi, I., and Vershina, E.A. (2000). Nociceptive system response to repetitive painful stimuli during chronic psychoemotional stress in humans. *Russ. Fiziol. Zh. Im. I. M. Sechenova* **86**, 1441–1448.
- Baccei, M.L., and Fitzgerald, M. (2005). Intrinsic firing properties of developing rat superficial dorsal horn neurons. *Neuroreport* **16**, 1325–1328.
- Backonja, M.M. (2003). Defining neuropathic pain. *Anesth. Analg.* **97**, 785–790.
- Bar-Yosef, S., Melamed, R., Page, G.G., Shakhar, G., Shakhar, K., and Ben-Eliyahu, S. (2001). Attenuation of the tumor-promoting effect of surgery by spinal blockade in rats. *Anesthesiology* **94**, 1066–1073.
- Beggs, S., Torsney, C., Drew, L.J., and Fitzgerald, M. (2002). The postnatal reorganization of primary afferent input and dorsal horn cell receptive fields in the rat spinal cord is an activity-dependent process. *Eur. J. Neurosci.* **16**, 1249–1258.
- Beiche, F., Scheuerer, S., Brune, K., Geisslinger, G., and Goppelt-Struebe, M. (1996). Up-regulation of cyclooxygenase-2 mRNA in the rat spinal cord following peripheral inflammation. *FEBS Lett.* **390**, 165–169.
- Beilin, B., Bessler, H., Mayburd, E., Smirnov, G., Dekel, A., Yardeni, I., and Shavit, Y. (2003a). Effects of preemptive analgesia on pain and cytokine production in the postoperative period. *Anesthesiology* **98**, 151–155.
- Beilin, B., Shavit, Y., Trabek, E., Mordashev, B., Mayburd, E., Zeidel, A., and Bessler, H. (2003b). The effects of postoperative pain management on immune response to surgery. *Anesth. Analg.* **97**, 822–827.
- Bennett, G.J. (2003). Neuropathic pain: A crisis of definition? *Anesth. Analg.* **97**, 619–620.
- Besedovsky, H., and del Rey, A. (1996). Immune-neuro-endocrine interactions: Facts and hypotheses. *Endocr. Rev.* **17**, 64–102.
- Bevan, S., and Szolcsanyi, J. (1990). Sensory neuron-specific actions of capsaicin: Mechanisms and applications. *Trends Pharmacol. Sci.* **11**, 331–333.
- Bhutta, A.T., Rovnaghi, C., Simpson, P.M., Gossett, J.M., Scalzo, F.M., and Anand, K.J. (2001). Interactions of inflammatory pain and morphine in infant rats: Long-term behavioral effects. *Physiol. Behav.* **73**, 51–58.
- Black, J.A., Dib-Hajj, S., McNabola, K., Jeste, S., Rizzo, M.A., Kocsis, J.D., and Waxman, S.G. (1996). Spinal sensory neurons express multiple sodium channel alpha-subunit mRNAs. *Brain Res. Mol. Brain Res.* **43**, 117–131.
- Black, J.A., Liu, S., Tanaka, M., Cummins, T.R., and Waxman, S.G. (2004a). Changes in the expression of tetrodotoxin-sensitive sodium channels within dorsal root ganglia neurons in inflammatory pain. *Pain* **108**, 237–247.
- Black, J.A., Liu, S., Tanaka, M., Cummins, T.R., and Waxman, S.G. (2004b). Changes in the expression of tetrodotoxin-sensitive sodium channels within dorsal root ganglia neurons in inflammatory pain. *Pain* **108**, 237–247.
- Bleakman, D., Alt, A., and Nisenbaum, E.S. (2006). Glutamate receptors and pain. *Semin. Cell Dev. Biol.* **17**, 592–604.
- Bodnar, I., Banky, Z., and Halasz, B. (2006). Non-NMDA glutamate receptor antagonist injected into the hypothalamic paraventricular nucleus inhibits the prolactin response to formalin stress of male rats. *Neurochem. Res.* **31**, 201–208.
- Bovivé, J. (1979). An anatomical reinvestigation of the termination of the spinothalamic tract in the monkey. *J. Comp. Neurol.* **186**, 343–369.
- Bonica, J. (1953). "The Management of Pain." Lea and Febiger, Philadelphia, PA.
- Boucher, T., Jennings, E., and Fitzgerald, M. (1998). The onset of diffuse noxious inhibitory controls in postnatal rat pups: A C-Fos study. *Neurosci. Lett.* **257**, 9–12.
- Brand, H.S., Gortzak, R.A., Palmer-Bouva, C.C., Abraham, R.E., and Abraham-Impijn, L. (1995). Cardiovascular and neuroendocrine responses during acute stress induced by different types of dental treatment. *Int. Dent. J.* **45**, 45–48.
- Burstein, R., Cliffer, K.D., and Giesler, G.J., Jr. (1990). Cells of origin of the spinothalamic tract in the rat. *J. Comp. Neurol.* **291**, 329–344.
- Burstein, R., Falkowsky, O., Borsook, D., and Strassman, A. (1996). Distinct lateral and medial projections of the spinothalamic tract of the rat. *J. Comp. Neurol.* **373**, 549–574.
- Canavero, S. (1994). Dynamic reverberation. A unified mechanism for central and phantom pain. *Med. Hypotheses* **42**, 203–207.
- Carstens, E., and Trevino, D.L. (1978). Laminar origins of spinothalamic projections in the cat as determined by the retrograde transport of horseradish peroxidase. *J. Comp. Neurol.* **182**, 161–165.
- Casey, K.L., Lorenz, J., and Minoshima, S. (2003). Insights into the pathophysiology of neuropathic pain through functional brain imaging. *Exp. Neurol.* **184** (Suppl 1), S80–S88.
- Casey, K.L., Minoshima, S., Morrow, T.J., and Koeppe, R.A. (1996). Comparison of human cerebral activation pattern during cutaneous warmth, heat pain, and deep cold pain. *J. Neurophysiol.* **76**, 571–581.
- Cavada, C., and Goldman-Rakic, P.S. (1989a). Posterior parietal cortex in rhesus monkey: I. Parcellation of areas based on distinctive limbic and sensory corticocortical connections. *J. Comp. Neurol.* **287**, 393–421.
- Cavada, C., and Goldman-Rakic, P.S. (1989b). Posterior parietal cortex in rhesus monkey: II. Evidence for segregated corticocortical networks linking sensory and limbic areas with the frontal lobe. *J. Comp. Neurol.* **287**, 422–445.
- Cervero, F., and Laird, J.M. (1996). From acute to chronic pain: Mechanisms and hypotheses. *Prog. Brain Res.* **110**, 3–15.
- Chapman, C.R. (2005). Pain perception and assessment. *Minerva Anestesiol.* **71**, 413–417.
- Chapman, C.R., and Nakamura, Y. (1999). A passion of the soul: An introduction to pain for consciousness researchers. *Conscious Cogn.* **8**, 391–422.
- Chapman, C.R., Nakamura, Y., Donaldson, G.W., Jacobson, R.C., Bradshaw, D.H., Flores, L., and Chapman, C.N. (2001). Sensory and affective dimensions of phasic pain are indistinguishable in the self-report and psychophysiology of normal laboratory subjects. *J. Pain* **2**, 279–294.
- Chen, L., and Huang, L.Y. (1992). Protein kinase C reduces Mg²⁺ block of NMDA-receptor channels as a mechanism of modulation. *Nature* **356**, 521–523.
- Chen, Y., Michaelis, M., Janig, W., and Devor, M. (1996). Adrenoreceptor subtype mediating sympathetic-sensory coupling in injured sensory neurons. *J. Neurophysiol.* **76**, 3721–3730.
- Cho, H.J., and Basbaum, A.I. (1991). GABAergic circuitry in the rostral ventral medulla of the rat and its relationship to descending antinociceptive controls. *J. Comp. Neurol.* **303**, 316–328.
- Chu, K.L., Faltynek, C.R., Jarvis, M.F., and McGaraughty, S. (2004). Increased WDR spontaneous activity and receptive field size in rats following a neuropathic or inflammatory injury: Implications for mechanical sensitivity. *Neurosci. Lett.* **372**, 123–126.
- Chung, K., Lee, B.H., Yoon, Y.W., and Chung, J.M. (1996). Sympathetic sprouting in the dorsal root ganglia of the injured peripheral nerve in a rat neuropathic pain model. *J. Comp. Neurol.* **376**, 241–252.
- Cizkova, D., Marsala, J., Lukacova, N., Marsala, M., Jergova, S., Orendacova, J., and Yaksh, T.L. (2002). Localization of N-type Ca²⁺ channels in the rat spinal cord following chronic constrictive nerve injury. *Exp. Brain Res.* **147**, 456–463.
- Cousins, M., and Power, I. (1999). Acute and post operative pain. In "Textbook of Pain" (P. Wall and R. Melzack, eds.), pp 447–491. Churchill, Edinburgh.
- Cox, J.J., Reimann, F., Nicholas, A.K., Thornton, G., Roberts, E., Springell, K., Karbani, G., Jaffi, H., Mannan, J., Raashid, Y., Al-Gazali, L., Hamamy, H.,

- Valente, E.M., Gorman, S., Williams, R., McHale, D.P., Wood, J.N., Gribble, F.M., and Woods, C.G. (2006). An SCN9A channelopathy causes congenital inability to experience pain. *444*, 894–898.
- Craig, A., and Dostrovsky, J.O. (1999). Medulla to thalamus. In “Textbook of Pain” (P. Wall and R. Melzack, eds.), pp 183–214. Churchill, Edinburgh.
- Cui, M., Feng, Y., McAdoo, D.J., and Willis, W.D. (1999). Periaqueductal gray stimulation-induced inhibition of nociceptive dorsal horn neurons in rats is associated with the release of norepinephrine, serotonin, and amino acids. *J. Pharmacol. Exp. Ther.* **289**, 868–876.
- Culman, J., Ritter, S., Ohlendorf, C., Haass, M., Maser-Gluth, C., Spitznagel, H., and Unger, T. (1997). A new formalin test allowing simultaneous evaluation of cardiovascular and nociceptive responses. *Can. J. Physiol. Pharmacol.* **75**, 1203–1211.
- Cummins, T.R., Dib-Hajj, S.D., Black, J.A., Akopian, A.N., Wood, J.N., and Waxman, S.G. (1999). A novel persistent tetrodotoxin-resistant sodium current in SNS-Null and wild-type small primary sensory neurons. *J. Neurosci.* **19**, 43RC.
- Cummins, T.R., Dib-Hajj, S.D., and Waxman, S.G. (2004). Electrophysiological properties of mutant Nav1.7 sodium channels in a painful inherited neuropathy. *J. Neurosci.* **24**, 8232–8236.
- Cummins, T.R., Howe, J.R., and Waxman, S.G. (1998). Slow closed-state inactivation: A novel mechanism underlying ramp currents in cells expressing the hNE/PN1 sodium channel. *J. Neurosci.* **18**, 9607–9619.
- Curatolo, M., Arendt-Nielsen, L., and Petersen-Felix, S. (2004). Evidence, mechanisms, and clinical implications of central hyper-sensitivity in chronic pain after whiplash injury. *Clin. J. Pain* **20**, 469–476.
- Dado, R.J., Katter, J.T., and Giesler, G.J., Jr. (1994a). Spinothalamic and spino-hypothalamic tract neurons in the cervical enlargement of rats. II. Responses to innocuous and noxious mechanical and thermal stimuli. *J. Neurophysiol.* **71**, 981–1002.
- Dado, R.J., Katter, J.T., and Giesler, G.J., Jr. (1994b). Spinothalamic and spinohypothalamic tract neurons in the cervical enlargement of rats. III. Locations of antidromically identified axons in the cervical cord white matter. *J. Neurophysiol.* **71**, 1003–1021.
- Davies, S.N., and Lodge, D. (1987). Evidence for involvement of *N*-methylaspartate receptors in “wind-up” of class 2 neurones in the dorsal horn of the rat. *Brain Res.* **424**, 402–406.
- Debarge, V.H., Sicot, B., Jaillard, S., Gueorgiva, I., Delelis, A., Deruelle, P., Ducloy, A.S., and Storme, L. (2007). The mechanisms of pain-induced pulmonary vasoconstriction: An experimental study in fetal lambs. *Anesth. Analg.* **104**, 799–806.
- Decosterd, I., Ji, R.R., Abdi, S., Tate, S., and Woolf, C.J. (2002). The pattern of expression of the voltage-gated sodium channels Na(v)1.8 and Na(v)1.9 does not change in uninjured primary sensory neurons in experimental neuropathic pain models. *Pain* **96**, 269–277.
- DeKeyser, F.G., Leker, R.R., and Weidenfeld, J. (2000). Activation of the adrenocortical axis by surgical stress: Involvement of central norepinephrine and interleukin-1. *Neuroimmunomodulation* **7**, 182–188.
- De Lahunta, A. (1977). “Veterinary Neuroanatomy and Clinical Neurology.” W.B. Saunders, Philadelphia, PA.
- DeLeo, J.A., Tanga, F.Y., and Tawfik, V.L. (2004). Neuroimmune activation and neuroinflammation in chronic pain and opioid tolerance/hyperalgesia. *Neuroscientist* **10**, 40–52.
- DeLeo, J.A., Tawfik, V.L., and LaCroix-Fralish, M.L. (2006). The tetra-partite synapse: Path to CNS sensitization and chronic pain. *Pain* **122**, 17–21.
- DeLeo, J.A., and Yezierski, R.P. (2001). The role of neuroinflammation and neuroimmune activation in persistent pain. *Pain* **90**, 1–6.
- de Novellis, V., Siniscalco, D., Galderisi, U., Fuccio, C., Nolano, M., Santoro, L., Cascino, A., Roth, K.A., Rossi, F., and Maione, S. (2004). Blockade of glutamate mGlu5 receptors in a rat model of neuropathic pain prevents early over-expression of pro-apoptotic genes and morphological changes in dorsal horn lamina II. *Neuropharmacology* **46**, 468–479.
- Devor, M., Keller, C.H., Deerinck, T.J., Levinson, S.R., and Ellisman, M.H. (1989). Na⁺ channel accumulation on axolemma of afferent endings in nerve end neuromas in *Apterionotus*. *Neurosci. Lett.* **102**, 149–154.
- Dhokariker, P., Caywood, D.D., Stobie, D., Raffae, M.R., Albrecht, M., Kannan, M., King, V., Hegstad, B., and Randall, D. (1996). Effects of intramuscular or interpleural administration of morphine and interpleural administration of bupivacaine on pulmonary function in dogs that have undergone median sternotomy. *Am. J. Vet. Res.* **57**, 375–380.
- Diatchenko, L., Nackley, A.G., Slade, G.D., Bhalang, K., Belfer, I., Max, M.B., Goldman, D., and Maixner, W. (2006). Catechol-*O*-methyltransferase gene polymorphisms are associated with multiple pain-evoking stimuli. *Pain* **125**, 216–224.
- Dib-Hajj, S., Black, J., Cummins, T., and Waxman, S. (2002). Na⁺/Nav1.9: A sodium channel with unique properties. *Trends Neurosci.* **25**, 253–259.
- Dickenson, A.H., and Sullivan, A.F. (1987). Evidence for a role of the NMDA receptor in the frequency dependent potentiation of deep rat dorsal horn nociceptive neurones following c fibre stimulation. *Neuropharmacology* **26**, 1235–1238.
- Djohri, L., Koutsikou, S., Fang, X., McMullan, S., and Lawson, S.N. (2006). Spontaneous pain, both neuropathic and inflammatory, is related to frequency of spontaneous firing in intact C-fiber nociceptors. *J. Neurosci.* **26**, 1281–1292.
- Drummond, P.D., Skipworth, S., and Finch, P.M. (1996). Alpha 1-adrenoceptors in normal and hyperalgesic human skin. *Clin. Sci. (Lond.)* **91**, 73–77.
- Dubner, R., and Bennett, G.J. (1983). Spinal and trigeminal mechanisms of nociception. *Annu. Rev. Neurosci.* **6**, 381–418.
- Dubner, R., and Ren, K. (1999). In “Textbook of Pain” (P. Wall and R. Melzack, eds.), pp 359–369. Churchill, Edinburgh.
- Duggan, A.W., Hope, P.J., Jarrott, B., Schaible, H.G., and Fleetwood-Walker, S.M. (1990). Release, spread and persistence of immunoreactive neurokinin A in the dorsal horn of the cat following noxious cutaneous stimulation. Studies with antibody microprobes. *Neuroscience* **35**, 195–202.
- Duggan, A.W., Riley, R.C., Mark, M.A., Macmillan, S.J.A., and Schaible, H.-G. (1995). Afferent volley patterns and the spinal release of immunoreactive substance P in the dorsal horn of the anaesthetized spinal cat. *Neuroscience* **65**, 849–858.
- Dworkin, R.H., Backonja, M., Rowbotham, M.C., Allen, R.R., Argoff, C.R., Bennett, G.J., Bushnell, M.C., Farrar, J.T., Galer, B.S., Haythornthwaite, J.A., Hewitt, D.J., Loeser, J.D., Max, M.B., Saltarelli, M., Schmadler, K.E., Stein, C., Thompson, D., Turk, D.C., Wallace, M.S., Watkins, L.R., and Weinstein, S.M. (2003). Advances in neuropathic pain: Diagnosis, mechanisms, and treatment recommendations. *Arch. Neurol.* **60**, 1524–1534.
- Erdogan, M., Erdogan, A., Erbil, N., Karakaya, H.K., and Demircan, A. (2005). Prospective, randomized, placebo-controlled study of the effect of TENS on postthoracotomy pain and pulmonary function. *World J. Surg.* **29**, 1563–1570.
- Fang, X., Djohri, L., Black, J.A., Dib-Hajj, S.D., Waxman, S.G., and Lawson, S.N. (2002). The presence and role of the tetrodotoxin-resistant sodium channel Na(v)1.9 (NaN) in nociceptive primary afferent neurons. *J. Neurosci.* **22**, 7425–7433.
- Fields, H.L., Heinricher, M.M., and Mason, P. (1991). Neurotransmitters in nociceptive modulatory circuits. *Annu. Rev. Neurosci.* **14**, 219–245.
- Fitzgerald, M. (2005). The development of nociceptive circuits. *Nat. Rev. Neurosci.* **6**, 507–520.
- Fitzgerald, M., and Gibson, S. (1984). The postnatal physiological and neurochemical development of peripheral sensory C fibres. *Neuroscience* **13**, 933–944.
- Fitzgerald, M., and Jennings, E. (1999). The postnatal development of spinal sensory processing. *Proc. Natl. Acad. Sci. U.S.A.* **96**, 7719–7722.
- Flecknell, P.A., Kirk, A.J., Liles, J.H., Hayes, P.H., and Dark, J.H. (1991). Post-operative analgesia following thoracotomy in the dog: An evaluation of the effects of bupivacaine intercostal nerve block and nalbuphine on respiratory function. *Lab. Anim.* **25**, 319–324.

- Forys, K.L., and Dahlquist, L.M. (2007). The influence of preferred coping style and cognitive strategy on laboratory-induced pain. *Health Psychol.* **26**, 22–29.
- Frassoni, C., Arcelli, P., Regondi, M.C., Selvaggio, M., De Biasi, S., and Spreafico, R. (1995). Branching pattern of corticothalamic projections from the somatosensory cortex during postnatal development in the rat. *Brain Res. Dev. Brain Res.* **90**, 111–121.
- Garcia-Anoveros, J., Samad, T.A., Zuvela-Jelaska, L., Woolf, C.J., and Corey, D.P. (2001). Transport and localization of the DEG/ENaC ion channel BNaC1alpha to peripheral mechanosensory terminals of dorsal root ganglia neurons. *J. Neurosci.* **21**, 2678–2686.
- George, S.Z., Wittmer, V.T., Fillingim, R.B., and Robinson, M.E. (2007). Sex and pain-related psychological variables are associated with thermal pain sensitivity for patients with chronic low back pain. *J. Pain* **8**, 2–10.
- Giesler, G.J., Menetrey, D., Guilbaud, G., and Besson, J.M. (1976). Lumbar cord neurons at the origin of the spinothalamic tract in the rat. *Brain Res.* **118**, 320–324.
- Giesler, G.J., Jr., Spiel, H.R., and Willis, W.D. (1981). Organization of spinothalamic tract axons within the rat spinal cord. *J. Comp. Neurol.* **195**, 243–252.
- Giordano, J. (2005). The neurobiology of nociceptive and anti-nociceptive systems. *Pain Physician.* **8**, 277–290.
- Gold, M.S., Levine, J.D., and Correa, A.M. (1998). Modulation of TTX-R INa by PKC and PKA and their role in PGE2-induced sensitization of rat sensory neurons in vitro. *J. Neurosci.* **18**, 10345–10355.
- Gold, M.S., Weinreich, D., Kim, C.S., Wang, R., Treanor, J., Porreca, F., and Lai, J. (2003). Redistribution of Na(V)1.8 in uninjured axons enables neuropathic pain. *J. Neurosci.* **23**, 158–166.
- Granovsky, Y., Matre, D., Sokolik, A., Lorenz, J., and Casey, K.L. (2005). Thermoreceptive innervation of human glabrous and hairy skin: A contact heat evoked potential analysis. *Pain* **115**, 238–247.
- Guy, E.R., and Abbott, F.V. (1992). The behavioral response to formalin in preweanling rats. *Pain* **51**, 81–90.
- Hagelberg, N., Jaaskelainen, S.K., Martikainen, I.K., Mansikka, H., Forssell, H., Scheinin, H., Hietala, J., and Pertovaara, A. (2004). Striatal dopamine D2 receptors in modulation of pain in humans: A review. *Eur. J. Pharmacol.* **500**, 187–192.
- Hains, B.C., Saab, C.Y., Klein, J.P., Craner, M.J., and Waxman, S.G. (2004). Altered sodium channel expression in second-order spinal sensory neurons contributes to pain after peripheral nerve injury. *J. Neurosci.* **24**, 4832–4839.
- Hains, B.C., Saab, C.Y., and Waxman, S.G. (2006). Alterations in burst firing of thalamic VPL neurons and reversal by Na(v)1.3 antisense after spinal cord injury. *J. Neurophysiol.* **95**, 3343–3352.
- Hains, B.C., Willis, W.D., and Hulsebosch, C.E. (2003). Temporal plasticity of dorsal horn somatosensory neurons after acute and chronic spinal cord hemisection in rat. *Brain Res.* **970**, 238–241.
- Handwerker, H.O., and Kobal, G. (1993). Psychophysiology of experimentally induced pain. *Physiol. Rev.* **73**, 639–671.
- Hansson, E., and Ronnback, L. (2004). Altered neuronal–glial signaling in glutamatergic transmission as a unifying mechanism in chronic pain and mental fatigue. *Neurochem. Res.* **29**, 989–996.
- Harvey, R.J., Depner, U.B., Wassle, H., Ahmadi, S., Heindl, C., Reinold, H., Smart, T.G., Harvey, K., Schutz, B., Abo-Salem, O.M., Zimmer, A., Poisbeau, P., Welzl, H., Wolfner, D.P., Betz, H., Zeilhofer, H.U., and Muller, U. (2004). GlyR {alpha}3: An essential target for spinal PGE2-mediated inflammatory pain sensitization. *Science* **304**, 884–887.
- Hassanzadeh, P., and Ahmadiani, A. (2006). Nitric oxide and c-Jun N-terminal kinase are involved in the development of dark neurons induced by inflammatory pain. *Synapse* **59**, 101–106.
- Hay, C.H., Trevethick, M.A., Wheeldon, A., Bowers, J.S., and De Belleruche, J.S. (1997). The potential role of spinal cyclooxygenase-2 in the development of Freund's complete adjuvant-induced changes in hyperalgesia and allodynia. *Neuroscience* **78**, 843–850.
- Hayashi, T., and Huganir, R.L. (2004). Tyrosine phosphorylation and regulation of the AMPA receptor by SRC family tyrosine kinases. *J. Neurosci.* **24**, 6152–6160.
- Heinricher, M.M., Cheng, Z.F., and Fields, H.L. (1987). Evidence for two classes of nociceptive modulating neurons in the periaqueductal gray. *J. Neurosci.* **7**, 271–278.
- Herrero, J.F., Laird, J.M., and Lopez-Garcia, J.A. (2000). Wind-up of spinal cord neurones and pain sensation: Much ado about something? *Prog. Neurobiol.* **61**, 169–203.
- Herzog, R.I., Cummins, T.R., Ghassemi, F., Dib-Hajj, S.D., and Waxman, S.G. (2003). Distinct repriming and closed-state inactivation kinetics of Nav1.6 and Nav1.7 sodium channels in mouse spinal sensory neurons. *J. Physiol.* **551**, 741–750.
- Hingtgen, C.M., and Vasko, M.R. (1994). Prostacyclin enhances the evoked-release of substance P and calcitonin gene-related peptide from rat sensory neurons. *Brain Res.* **655**, 51–60.
- Hirakawa, N., Tershner, S.A., and Fields, H.L. (1999). Highly delta selective antagonists in the RVM attenuate the antinociceptive effect of PAG DAMGO. *Neuroreport* **10**, 3125–3129.
- Hoar, P.F., Hickey, R.F., and Ulyot, D.J. (1976). Systemic hypertension following myocardial revascularization. A method of treatment using epidural anesthesia. *J. Thorac. Cardiovasc. Surg.* **71**, 859–864.
- Hohmann, A.G., Neely, M.H., Pina, J., and Nackley, A.G. (2005). Neonatal chronic hind paw inflammation alters sensitization to intradermal capsaicin in adult rats: A behavioral and immunocytochemical study. *J. Pain* **6**, 798–808.
- Honore, P., Rogers, S.D., Schwei, M.J., Salak-Johnson, J.L., Luger, N.M., Sabino, M.C., Clohisey, D.R., and Mantyh, P.W. (2000). Murine models of inflammatory, neuropathic and cancer pain each generates a unique set of neurochemical changes in the spinal cord and sensory neurons. *Neuroscience* **98**, 585–598.
- Hope, P.J., Jarrott, B., Schaible, H.G., Clarke, R.W., and Duggan, A.W. (1990). Release and spread of immunoreactive neurokinin A in the cat spinal cord in a model of acute arthritis. *Brain Res.* **533**, 292–299.
- Hu, J., Mata, M., Hao, S., Zhang, G., and Fink, D.J. (2004). Central sprouting of uninjured small fiber afferents in the adult rat spinal cord following spinal nerve ligation. *Eur. J. Neurosci.* **20**, 1705–1712.
- Huang, L.Y. (1989). Origin of thalamically projecting somatosensory relay neurons in the immature rat. *Brain Res.* **495**, 108–114.
- Ikedo, H., Stark, J., Fischer, H., Wagner, M., Drdla, R., Jager, T., and Sandkuhler, J. (2006). Synaptic amplifier of inflammatory pain in the spinal dorsal horn. *Science* **312**, 1659–1662.
- Inoue, K. (2006). The function of microglia through purinergic receptors: Neuropathic pain and cytokine release. *Pharmacol. Ther.* **109**, 210–226.
- Jennings, E., and Fitzgerald, M. (1998). Postnatal changes in responses of rat dorsal horn cells to afferent stimulation: A fibre-induced sensitization. *J. Physiol.* **509** (Pt 3), 859–868.
- Ji, R.-R., Befort, K., Brenner, G.J., and Woolf, C.J. (2002). ERK MAP kinase activation in superficial spinal cord neurons induces prodynorphin and NK-1 upregulation and contributes to persistent inflammatory pain hypersensitivity. *J. Neurosci.* **22**, 478–485.
- Ji, R.R., Kohno, T., Moore, K.A., and Woolf, C.J. (2003). Central sensitization and LTP: Do pain and memory share similar mechanisms? *Trends Neurosci.* **26**, 696–705.
- Ji, R.R., and Woolf, C.J. (2001). Neuronal plasticity and signal transduction in nociceptive neurons: Implications for the initiation and maintenance of pathological pain. *Neurobiol. Dis.* **8**, 1–10.
- Jones, M.W., Apkarian, A.V., Stevens, R.T., and Hodge, C.J., Jr. (1987). The spinothalamic tract: An examination of the cells of origin of the dorsolateral and ventral spinothalamic pathways in cats. *J. Comp. Neurol.* **260**, 349–361.
- Julius, D., and Basbaum, A.I. (2001). Molecular mechanisms of nociception. *Nature* **413**, 203–210.
- Karl, A., Birbaumer, N., Lutzenberger, W., Cohen, L.G., and Flor, H. (2001). Reorganization of motor and somatosensory cortex in upper extremity amputees with phantom limb pain. *J. Neurosci.* **21**, 3609–3618.

- Karl, A., Muhlneckel, W., Kurth, R., and Flor, H. (2004). Neuroelectric source imaging of steady-state movement-related cortical potentials in human upper extremity amputees with and without phantom limb pain. *Pain* **110**, 90–102.
- Kato, G., Yasaka, T., Katafuchi, T., Furue, H., Mizuno, M., Iwamoto, Y., and Yoshimura, M. (2006). Direct GABAergic and glycinergic inhibition of the substantia gelatinosa from the rostral ventromedial medulla revealed by in vivo patch-clamp analysis in rats. *J. Neurosci.* **26**, 1787–1794.
- Katter, J.T., Burstein, R., and Giesler, G.J., Jr. (1991). The cells of origin of the spinothalamic tract in cats. *J. Comp. Neurol.* **303**, 101–112.
- Kehlet, H. (1988). The modifying effect of anesthetic technique on the metabolic and endocrine responses to anesthesia and surgery. *Acta Anaesthesiol. Belg.* **39**, 143–146.
- Kehlet, H. (1989). Surgical stress: The role of pain and analgesia. *Br. J. Anaesth.* **63**, 189–195.
- Kerr, F.W. (1975). The ventral spinothalamic tract and other ascending systems of the ventral funiculus of the spinal cord. *J. Comp. Neurol.* **159**, 335–356.
- Khakh, B.S., and North, R.A. (2006). P2X receptors as cell-surface ATP sensors in health and disease. *Nature* **442**, 527–532.
- Kim, H., Mittal, D.P., Iadarola, M.J., and Dionne, R.A. (2006). Genetic predictors for acute experimental cold and heat pain sensitivity in humans. *J. Med. Genet.* **43**, e40.
- Klassen, G.A., Bramwell, R.S., Bromage, P.R., and Zborowska-Sluis, D.T. (1980). Effect of acute sympathectomy by epidural anesthesia on the canine coronary circulation. *Anesthesiology* **52**, 8–15.
- Klop, E.M., Mouton, L.J., and Holstege, G. (2005). Segmental and laminar organization of the spinothalamic neurons in cat: Evidence for at least five separate clusters. *J. Comp. Neurol.* **493**, 580–595.
- Koleck, M., Mazaux, J.M., Rasclé, N., and Bruchon-Schweitzer, M. (2006). Psycho-social factors and coping strategies as predictors of chronic evolution and quality of life in patients with low back pain: A prospective study. *Eur. J. Pain* **10**, 1–11.
- Kostarczyk, E., Zhang, X., and Giesler, G.J., Jr. (1997). Spinothalamic tract neurons in the cervical enlargement of rats: Locations of antidromically identified ascending axons and their collateral branches in the contralateral brain. *J. Neurophysiol.* **77**, 435–451.
- Kunz, S., Tegeder, I., Coste, O., Marian, C., Pfenninger, A., Corvey, C., Karas, M., Geisslinger, G., and Niederberger, E. (2005). Comparative proteomic analysis of the rat spinal cord in inflammatory and neuropathic pain models. *Neurosci. Lett.* **381**, 289–293.
- Kuroda, M., Yokofujita, J., Oda, S., and Price, J.L. (2004). Synaptic relationships between axon terminals from the mediodorsal thalamic nucleus and gamma-aminobutyric acidergic cortical cells in the prelimbic cortex of the rat. *J. Comp. Neurol.* **477**, 220–234.
- Kuzumaki, N., Narita, M., Hareyama, N., Niikura, K., Nagumo, Y., Nozaki, H., Amano, T., and Suzuki, T. (2007). Chronic pain-induced astrocyte activation in the cingulate cortex with no change in neural or glial differentiation from neural stem cells in mice. *Neurosci. Lett.* **415**, 22–27.
- Laemmle, B., Schindler, M., Beilmann, M., Hamilton, B.S., Doods, H.N., and Wieland, H.A. (2003). Characterization of the NPGP receptor and identification of a novel short mRNA isoform in human hypothalamus. *Regul. Pept.* **111**, 21–29.
- Lai, J., Gold, M.S., Kim, C.S., Bian, D., Ossipov, M.H., Hunter, J.C., and Porreca, F. (2002). Inhibition of neuropathic pain by decreased expression of the tetrodotoxin-resistant sodium channel, NaV1.8. *Pain* **95**, 143–152.
- Lai, J., Porreca, F., Hunter, J.C., and Gold, M.S. (2004). Voltage-gated sodium channels and hyperalgesia. *Annu. Rev. Pharmacol. Toxicol.* **44**, 371–397.
- Lampert, A., Hains, B.C., and Waxman, S.G. (2006). Upregulation of persistent and ramp sodium current in dorsal horn neurons after spinal cord injury. *Exp. Brain Res.* **174**, 660–666.
- Ledeboer, A., Sloane, E.M., Milligan, E.D., Frank, M.G., Mahony, J.H., Maier, S.F., and Watkins, L.R. (2005). Minocycline attenuates mechanical allodynia and proinflammatory cytokine expression in rat models of pain facilitation. *Pain* **115**, 71–83.
- Leem, J.W., Lee, B.H., Willis, W.D., and Chung, J.M. (1994). Grouping of somatosensory neurons in the spinal cord and the gracile nucleus of the rat by cluster analysis. *J. Neurophysiol.* **72**, 2590–2597.
- Lenz, F.A., Weiss, N., Ohara, S., Lawson, C., and Greenspan, J.D. (2004). The role of the thalamus in pain. *Suppl. Clin. Neurophysiol.* **57**, 50–61.
- Lewis, K.S., Whipple, J.K., Michael, K.A., and Quebbeman, E.J. (1994). Effect of analgesic treatment on the physiological consequences of acute pain. *Am. J. Hosp. Pharm.* **51**, 1539–1554.
- Lin, C., and Al-Chaer, E.D. (2003). Long-term sensitization of primary afferents in adult rats exposed to neonatal colon pain. *Brain Res.* **971**, 73–82.
- Lin, Q., Peng, Y., and Willis, W.D. (1994). Glycine and GABA antagonists reduce the inhibition of primate spinothalamic tract neurons produced by stimulation in periaqueductal gray. *Brain Res.* **654**, 286–302.
- Lin, Q., Peng, Y.B., and Willis, W.D. (1996). Role of GABA receptor subtypes in inhibition of primate spinothalamic tract neurons: Difference between spinal and periaqueductal gray inhibition. *J. Neurophysiol.* **75**, 109–123.
- Lin, Q., Zou, X., and Willis, W.D. (2000). A delta and C primary afferents convey dorsal root reflexes after intradermal injection of capsaicin in rats. *J. Neurophysiol.* **84**, 2695–2698.
- Liu, C.N., Devor, M., Waxman, S.G., and Kocsis, J.D. (2002). Subthreshold oscillations induced by spinal nerve injury in dissociated muscle and cutaneous afferents of mouse DRG. *J. Neurophysiol.* **87**, 2009–2017.
- Liu, C.N., Wall, P.D., Ben-Dor, E., Michaelis, M., Amir, R., and Devor, M. (2000). Tactile allodynia in the absence of C-fiber activation: Altered firing properties of DRG neurons following spinal nerve injury. *Pain* **85**, 503–521.
- Luo, Z.D., Chaplan, S.R., Higuera, E.S., Sorkin, L.S., Stauderman, K.A., Williams, M.E., and Yaksh, T.L. (2001). Upregulation of dorsal root ganglion (alpha)2(delta) calcium channel subunit and its correlation with allodynia in spinal nerve-injured rats. *J. Neurosci.* **21**, 1868–1875.
- Maeda, Y., Lisi, T.L., Vance, C.G., and Sluka, K.A. (2007). Release of GABA and activation of GABA(A) in the spinal cord mediates the effects of TENS in rats. *Brain Res.* **1136**, 43–50.
- Magora, F., Cohen, S., Shochina, M., and Dayan, E. (2006). Virtual reality immersion method of distraction to control experimental ischemic pain. *Isr. Med. Assoc. J.* **8**, 261–265.
- Malcangio, M., Ramer, M.S., Jones, M.G., and McMahon, S.B. (2000). Abnormal substance P release from the spinal cord following injury to primary sensory neurons. *Eur. J. Neurosci.* **12**, 397–399.
- Malick, A., Strassman, R.M., and Burstein, R. (2000). Trigeminothalamic and reticulohypothalamic tract neurons in the upper cervical spinal cord and caudal medulla of the rat. *J. Neurophysiol.* **84**, 2078–2112.
- Malmberg, A.B., and Yaksh, T.L. (1993). Spinal nitric oxide synthesis inhibition blocks NMDA-induced thermal hyperalgesia and produces antinociception in the formalin test in rats. *Pain* **54**, 291–300.
- Mamet, J., Baron, A., Lazdunski, M., and Voilley, N. (2002). Proinflammatory mediators, stimulators of sensory neuron excitability via the expression of acid-sensing ion channels. *J. Neurosci.* **22**, 10662–10670.
- Mamet, J., Lazdunski, M., and Voilley, N. (2003). How nerve growth factor drives physiological and inflammatory expressions of acid-sensing ion channel 3 in sensory neurons. *J. Biol. Chem.* **278**, 48907–48913.
- Manchikanti, L., Fellows, B., and Singh, V. (2002). Understanding psychological aspects of chronic pain in interventional pain management. *Pain Physician* **5**, 57–82.
- Mancia, M., Mariotti, M., Caraceni, A., Formenti, A., Imeri, L., and Palestini, M. (1987). Center median parafascicular thalamic complex and mediodorsal nucleus unitary responses to noxious stimuli and their conditioning by limbic and mesencephalic stimulations. In “Advances in Pain Research and Therapy.” (E.J. Tiengo, M., Cuello A.C., Ottoson, D., ed.), Vol. 10, pp 17–30. Raven Press, New York.
- Mannion, R.J., Costigan, M., Decosterd, I., Amaya, F., Ma, Q.-P., Holstege, J.C., Ji, R.-R., Acheson, A., Lindsay, R.M., Wilkinson, G.A., and Woolf, C.J. (1999). Neurotrophins: Peripherally and centrally acting modulators of tactile stimulus-induced inflammatory pain hypersensitivity. *PNAS* **96**, 9385–9390.

- Mantyh, P.W. (1983). The terminations of the spinothalamic tract in the cat. *Neurosci. Lett.* **38**, 119–124.
- Mantyh, P.W., and Hunt, S.P. (2004). Mechanisms that generate and maintain bone cancer pain. *Novartis Found. Symp.* **260**, 221–238; discussion 238–240, 277–279.
- Martin, R.J., Apkarian, A.V., and Hodge, C.J., Jr. (1990). Ventrolateral and dorsolateral ascending spinal cord pathway influence on thalamic nociception in cat. *J. Neurophysiol.* **64**, 1400–1412.
- McCleskey, E.W., and Gold, M.S. (1999). Ion channels of nociception. *Annu. Rev. Physiol.* **61**, 835–856.
- McGovern, J.G. (2006). Targeting N-type and T-type calcium channels for the treatment of pain. *Drug Discov. Today* **11**, 245–253.
- McHaffie, J.G., Wang, S., Walton, N., Stein, B.E., and Redgrave, P. (2002). Covariant maturation of nocifensive oral behaviour and c-fos expression in rat superior colliculus. *Neuroscience* **109**, 597–607.
- McKelvey, A.D., Mark, T.R., and Sweitzer, S.M. (2007). Age- and sex-specific nociceptive response to endothelin-1. *J. Pain* **8**, 657–666.
- Melcangic, M., and Bowery, N.G. (1996). GABA and its receptors in the spinal cord. *Trends Pharmacol. Sci.* **17**, 457–462.
- Mellor, D.J., Diesch, T.J., Gunn, A.J., and Bennet, L. (2005). The importance of 'awareness' for understanding fetal pain. *Brain Res. Brain Res. Rev.* **49**, 455–471.
- Mellor, D.J., and Gregory, N.G. (2003). Responsiveness, behavioural arousal and awareness in fetal and newborn lambs: Experimental, practical and therapeutic implications. *N.Z. Vet. J.* **51**, 2–13.
- Mellor, D.J., Stafford, K.J., Todd, S.E., Lowe, T.E., Gregory, N.G., Bruce, R.A., and Ward, R.N. (2002). A comparison of catecholamine and cortisol responses of young lambs and calves to painful husbandry procedures. *Aust. Vet. J.* **80**, 228–233.
- Mendell, L.M., and Wall, P.D. (1965). Responses of single dorsal cord cells to peripheral cutaneous unmyelinated fibres. *Nature* **206**, 97–99.
- Merskey, H., and Bogduk, N. (1994). "Classification of Chronic Pain Descriptions of Chronic Pain Syndromes and Definitions of Pain Terms." pp 1–215. IASP press, Seattle, WA.
- Miao, F.J., and Levine, J.D. (1999). Neural and endocrine mechanisms mediating noxious stimulus-induced inhibition of bradykinin plasma extravasation in the rat. *J. Pharmacol. Exp. Ther.* **291**, 1028–1037.
- Michael, G.J., and Priestley, J.V. (1999). Differential expression of the mRNA for the vanilloid receptor subtype 1 in cells of the adult rat dorsal root and nodose ganglia and its downregulation by axotomy. *J. Neurosci.* **19**, 1844–1854.
- Mika, J., Osikowicz, M., Makuch, W., and Przewlocka, B. (2007). Minocycline and pentoxifylline attenuate allodynia and hyperalgesia and potentiate the effects of morphine in rat and mouse models of neuropathic pain. *Eur. J. Pharmacol.* **560**, 142–149.
- Millan, M.J. (1999). The induction of pain: An integrative review. *Prog. Neurobiol.* **57**, 1–164.
- Miller, C., and Newton, S.E. (2006). Pain perception and expression: The influence of gender, personal self-efficacy, and lifespan socialization. *Pain Manag. Nurs.* **7**, 148–152.
- Milligan, E., Zapata, V., Schoeniger, D., Chacur, M., Green, P., Poole, S., Martin, D., Maier, S.F., and Watkins, L.R. (2005). An initial investigation of spinal mechanisms underlying pain enhancement induced by fractalkine, a neuronally released chemokine. *Eur. J. Neurosci.* **22**, 2775–2782.
- Milligan, E.D., Twining, C., Chacur, M., Biedenkapp, J., O'Connor, K., Poole, S., Tracey, K., Martin, D., Maier, S.F., and Watkins, L.R. (2003). Spinal glia and proinflammatory cytokines mediate mirror-image neuropathic pain in rats. *J. Neurosci.* **23**, 1026–1040.
- Mineta, K., Nomura, M., Terado, M., Fujimoto, N., Sasaguri, T., Ueta, Y., and Matsumoto, T. (2004). Upregulation of corticotropin-releasing hormone gene expression in the paraventricular nucleus of cyclophosphamide-induced cystitis in male rats. *Brain Res.* **1018**, 193–200.
- Mogil, J.S., Ritchie, J., Smith, S.B., Strasburg, K., Kaplan, L., Wallace, M.R., Romberg, R.R., Bijl, H., Sarton, E.Y., Fillingim, R.B., and Dahan, A. (2005). Melanocortin-1 receptor gene variants affect pain and mu-opioid analgesia in mice and humans. *J. Med. Genet.* **42**, 583–587.
- Molony, V. (1997). Comments on Anand and Craig, PAIN, 67 (1996) 3–6. *Pain* **70**, 293.
- Molony, V., and Kent, J.E. (1997). Assessment of acute pain in farm animals using behavioral and physiological measurements. *J. Anim. Sci.* **75**, 266–272.
- Moore, K.A., Kohno, T., Karchewski, L.A., Scholz, J., Baba, H., and Woolf, C.J. (2002). Partial peripheral nerve injury promotes a selective loss of GABAergic inhibition in the superficial dorsal horn of the spinal cord. *J. Neurosci.* **22**, 6724–6731.
- Morgan, M.M., and Fields, H.L. (1994). Pronounced changes in the activity of nociceptive modulatory neurons in the rostral ventromedial medulla in response to prolonged thermal noxious stimuli. *J. Neurophysiol.* **72**, 1161–1170.
- Morgan, M.M., Gold, M.S., Liebeskind, J.C., and Stein, C. (1991). Periaqueductal gray stimulation produces a spinally mediated, opioid antinociception for the inflamed hindpaw of the rat. *Brain Res.* **545**, 17–23.
- Morrow, T.J., Paulson, P.E., Brewer, K.L., Yezierski, R.P., and Casey, K.L. (2000). Chronic, selective forebrain responses to excitotoxic dorsal horn injury. *Exp. Neurol.* **161**, 220–226.
- Muir, W.W. III, and Woolf, C.J. (2001). Mechanisms of pain and their therapeutic implications. *J. Am. Vet. Med. Assoc.* **219**, 1346–1356.
- Nakamura, S., and Atsuta, Y. (2004). Electrophysiological study on primary afferent properties of a chronic constriction nerve injury model in spinal rats. *J. Orthop. Sci.* **9**, 386–391.
- Narikashvili, S.P. (1976). Facts and reflections on thalamocortical reverberation of impulses. *Neurosci. Behav. Physiol.* **7**, 77–81.
- Narita, M., Yoshida, T., Nakajima, M., Miyatake, M., Takagi, T., Yajima, Y., and Suzuki, T. (2006). Direct evidence for spinal cord microglia in the development of a neuropathic pain-like state in mice. *J. Neurochem.* **97**, 1337–1348.
- Nassar, M.A., Stirling, L.C., Forlani, G., Baker, M.D., Matthews, E.A., Dickenson, A.H., and Wood, J.N. (2004). Nociceptor-specific gene deletion reveals a major role for Nav1.7 (PN1) in acute and inflammatory pain. *PNAS* **101**, 12706–12711.
- Neal, J.W., Pearson, R.C., and Powell, T.P. (1990). The connections of area PG, 7a, with cortex in the parietal, occipital and temporal lobes of the monkey. *Brain Res.* **532**, 249–264.
- Neto, F.L., Schadrack, J., Ableitner, A., Castro-Lopes, J.M., Bartenstein, P., Ziegler, W., and Tolle, T.R. (1999). Supraspinal metabolic activity changes in the rat during adjuvant monoarthritis. *Neuroscience* **94**, 607–621.
- Neubert, M.J., Kincaid, W., and Heinricher, M.M. (2004). Nociceptive facilitating neurons in the rostral ventromedial medulla. *Pain* **110**, 158–165.
- Neumann, S., Doubell, T.P., Leslie, T., and Woolf, C.J. (1996). Inflammatory pain hypersensitivity mediated by phenotypic switch in myelinated primary sensory neurons. *Nature* **384**, 360–364.
- Newton, R.A., Bingham, S., Case, P.C., Sanger, G.J., and Lawson, S.N. (2001). Dorsal root ganglion neurons show increased expression of the calcium channel $\alpha 2\delta$ -1 subunit following partial sciatic nerve injury. *Brain Res. Mol. Brain Res.* **95**, 1–8.
- Nothias, F., Peschanski, M., and Besson, J.M. (1988). Somatotopic reciprocal connections between the somatosensory cortex and the thalamic Po nucleus in the rat. *Brain Res.* **447**, 169–174.
- Numazaki, M., Tominaga, T., Toyooka, H., and Tominaga, M. (2002). Direct phosphorylation of capsaicin receptor VR1 by protein kinase C epsilon and identification of two target serine residues. *J. Biol. Chem.* **277**, 13375–13378.
- Nystedt, J.M., Lemberg, K., Lintunen, M., Mustonen, K., Holma, R., Kontinen, V.K., Kalso, E., and Panula, P. (2004). Pain- and morphine-associated transcriptional regulation of neuropeptide FF and the G-protein-coupled NPFF2 receptor gene. *Neurobiol. Dis.* **16**, 254–262.
- Obreja, O., Biasio, W., Andratsch, M., Lips, K.S., Rathee, P.K., Ludwig, A., Rose-John, S., and Kress, M. (2005). Fast modulation of heat-activated ionic current by proinflammatory interleukin 6 in rat sensory neurons. *Brain* **128**, 1634–1641.

- Odeh, F., and Antal, M. (2001). The projections of the midbrain periaqueductal grey to the pons and medulla oblongata in rats. *Eur. J. Neurosci.* **14**, 1275–1286.
- O'Hagan, B.J. (2006). Neuropathic pain in a cat post-amputation. *Aust. Vet. J.* **84**, 83–86.
- Onen, S.H., Alloui, A., Gross, A., Eschallier, A., and Dubray, C. (2001). The effects of total sleep deprivation, selective sleep interruption and sleep recovery on pain tolerance thresholds in healthy subjects. *J. Sleep Res.* **10**, 35–42.
- Osaki, M.Y., Castellan-Baldan, L., Calvo, F., Carvalho, A.D., Felippotti, T.T., de Oliveira, R., Ubiali, W.A., Paschoalin-Maurin, T., Elias-Filho, D.H., Motta, V., da Silva, L.A., and Coimbra, N.C. (2003). Neuroanatomical and neuropharmacological study of opioid pathways in the mesencephalic tectum: Effect of mu(1)- and kappa-opioid receptor blockade on escape behavior induced by electrical stimulation of the inferior colliculus. *Brain Res.* **992**, 179–192.
- Owolabi, S.A., and Saab, C.Y. (2006). Fractalkine and minocycline alter neuronal activity in the spinal cord dorsal horn. *FEBS Lett.* **580**, 4306–4310.
- Pacak, K., and Palkovits, M. (2001). Stressor specificity of central neuroendocrine responses: Implications for stress-related disorders. *Endocr. Rev.* **22**, 502–548.
- Pacak, K., Palkovits, M., Kvetnansky, R., Yadid, G., Kopin, I.J., and Goldstein, D.S. (1995). Effects of various stressors on in vivo norepinephrine release in the hypothalamic paraventricular nucleus and on the pituitary-adrenocortical axis. *Ann. N.Y. Acad. Sci.* **771**, 115–130.
- Page, G.G. (2003). The immune-suppressive effects of pain. *Adv. Exp. Med. Biol.* **521**, 117–125.
- Palkovits, M. (1999). Interconnections between the neuroendocrine hypothalamus and the central autonomic system. Geoffrey Harris Memorial Lecture, Kitakyushu, Japan, October 1998. *Front. Neuroendocrinol.* **20**, 270–295.
- Palkovits, M., Baffi, J.S., and Pacak, K. (1999). The role of ascending neuronal pathways in stress-induced release of noradrenaline in the hypothalamic paraventricular nucleus of rats. *J. Neuroendocrinol.* **11**, 529–539.
- Pan, B., Castro-Lopes, J.M., and Coimbra, A. (1997). Chemical sensory deafferentation abolishes hypothalamic pituitary activation induced by noxious stimulation or electroacupuncture but only decreases that caused by immobilization stress. A c-fos study. *Neuroscience* **78**, 1059–1068.
- Patrick Hartly, T., and Waxman, S.G. (2007). Inactivation properties of sodium channel Nav1.8 maintain action potential amplitude in small DRG neurons in the context of depolarization. *Mol. Pain* **3**, 12.
- Pertovaara, A., Wei, H., Kalmari, J., and Ruotsalainen, M. (2001). Pain behavior and response properties of spinal dorsal horn neurons following experimental diabetic neuropathy in the rat: Modulation by nitecapone, a COMT inhibitor with antioxidant properties. *Exp. Neurol.* **167**, 425–434.
- Peters, C.M., Ghilardi, J.R., Keyser, C.P., Kubota, K., Lindsay, T.H., Luger, N.M., Mach, D.B., Schwei, M.J., Sevcik, M.A., and Mantyh, P.W. (2005). Tumor-induced injury of primary afferent sensory nerve fibers in bone cancer pain. *Exp. Neurol.* **193**, 85–100.
- Petrenko, A.B., Yamakura, T., Baba, H., and Shimoji, K. (2003). The role of *N*-methyl-D-aspartate (NMDA) receptors in pain: A review. *Anesth. Analg.* **97**, 1108–1116.
- Pezet, S., Malcangio, M., and McMahon, S.B. (2002). BDNF: A neuromodulator in nociceptive pathways? *Brain Res. Brain Res. Rev.* **40**, 240–249.
- Pitcher, G.M., and Henry, J.L. (2000). Cellular mechanisms of hyperalgesia and spontaneous pain in a spinalized rat model of peripheral neuropathy: Changes in myelinated afferent inputs implicated. *Eur. J. Neurosci.* **12**, 2006–2220.
- Pool, G.J., Schwegler, A.F., Theodore, B.R., and Fuchs, P.N. (2007). Role of gender norms and group identification on hypothetical and experimental pain tolerance. *Pain* **129**, 122–129.
- Price, D.D., Hayes, R.L., Ruda, M., and Dubner, R. (1978). Neural representation of cutaneous aftersensations by spinothalamic tract neurons. *Fed. Proc.* **37**, 2237–2239.
- Price, D.D., Hu, J.W., Dubner, R., and Gracely, R.H. (1977). Peripheral suppression of first pain and central summation of second pain evoked by noxious heat pulses. *Pain* **3**, 57–68.
- Price, M.P., Lewin, G.R., McIlwraith, S.L., Cheng, C., Xie, J., Heppenstall, P.A., Stucky, C.L., Mannsfeldt, A.G., Brennan, T.J., Drummond, H.A., Qiao, J., Benson, C.J., Tarr, D.E., Hrstka, R.F., Yang, B., Williamson, R.A., and Welsh, M.J. (2000). The mammalian sodium channel BNC1 is required for normal touch sensation. *Nature* **407**, 1007–1011.
- Raghavendra, V., Tanga, F., and DeLeo, J.A. (2003). Inhibition of microglial activation attenuates the development but not existing hypersensitivity in a rat model of neuropathy. *J. Pharmacol. Exp. Ther.* **306**, 624–630.
- Raghavendra, V., Tanga, F.Y., and DeLeo, J.A. (2004). Complete Freund's adjuvant-induced peripheral inflammation evokes glial activation and proinflammatory cytokine expression in the CNS. *Eur. J. Neurosci.* **20**, 467–473.
- Rahim-Williams, F.B., Riley, J.L., 3rd, Herrera, D., Campbell, C.M., Hastie, B.A., and Fillingim, R.B. (2007). Ethnic identity predicts experimental pain sensitivity in African Americans and Hispanics. *Pain* **129**, 177–184.
- Raja, S.N., Meyer, R.A., Ringkamp, M., and Campbell, J. (1999). Peripheral mechanisms of nociception. In "Textbook of Pain" (P. Wall and R. Melzack, eds.), pp 11–57. Churchill, Edinburgh.
- Ralston, H.J. III, and Ralston, D.D. (1992). The primate dorsal spinothalamic tract: Evidence for a specific termination in the posterior nuclei (Po/SG) of the thalamus. *Pain* **48**, 107–118.
- Ramer, M.S., and Bisby, M.A. (1998). Normal and injury-induced sympathetic innervation of rat dorsal root ganglia increases with age. *J. Comp. Neurol.* **394**, 38–47.
- Randich, A., Uzzell, T., DeBerry, J.J., and Ness, T.J. (2006). Neonatal urinary bladder inflammation produces adult bladder hypersensitivity. *J. Pain* **7**, 469–479.
- Rashid, M.H., Inoue, M., Bakoshi, S., and Ueda, H. (2003a). Increased expression of vanilloid receptor 1 on myelinated primary afferent neurons contributes to the antihyperalgesic effect of capsaicin cream in diabetic neuropathic pain in mice. *J. Pharmacol. Exp. Ther.* **306**, 709–717.
- Rashid, M.H., Inoue, M., Kondo, S., Kawashima, T., Bakoshi, S., and Ueda, H. (2003b). Novel expression of vanilloid receptor 1 on capsaicin-insensitive fibers accounts for the analgesic effect of capsaicin cream in neuropathic pain. *J. Pharmacol. Exp. Ther.* **304**, 940–948.
- Rawal, N. (2001). Treating postoperative pain improves outcome. *Minerva Anesthesiol.* **67**, 200–205.
- Ren, K., Novikova, S.I., He, F., Dubner, R., and Lidow, M.S. (2005a). Neonatal local noxious insult affects gene expression in the spinal dorsal horn of adult rats. *Mol. Pain* **1**, 27.
- Ren, Y., Zou, X., Fang, L., and Lin, Q. (2005b). Sympathetic modulation of activity in Adelta- and C-primary nociceptive afferents after intradermal injection of capsaicin in rats. *J. Neurophysiol.* **93**, 365–377.
- Renganathan, M., Cummins, T.R., and Waxman, S.G. (2001). Contribution of Nav1.8 sodium channels to action potential electrogenesis in DRG neurons. *J. Neurophysiol.* **86**, 629–640.
- Reynolds, D.V. (1969). Surgery in the rat during electrical analgesia induced by focal brain stimulation. *Science* **164**, 444–445.
- Roediger, L., Joris, J., Senard, M., Larbuisson, R., Canivet, J.L., and Lamy, M. (2006). The use of pre-operative intrathecal morphine for analgesia following coronary artery bypass surgery. *Anaesthesia* **61**, 838–844.
- Roughan, J.V., Flecknell, P.A., and Davies, B.R. (2004). Behavioural assessment of the effects of tumour growth in rats and the influence of the analgesics carprofen and meloxicam. *Lab. Anim.* **38**, 286–296.
- Ruda, M.A., Ling, Q.D., Hohmann, A.G., Peng, Y.B., and Tachibana, T. (2000). Altered nociceptive neuronal circuits after neonatal peripheral inflammation. *Science* **289**, 628–631.
- Rush, A.M., Cummins, T.R., and Waxman, S.G. (2007). Multiple sodium channels and their roles in electrogenesis within dorsal root ganglion neurons. *J. Physiol.* **579**, 1–14.

- Rygh, L.J., Svendsen, F., Fiska, A., Haugan, F., Hole, K., and Tjolsen, A. (2005). Long-term potentiation in spinal nociceptive systems—how acute pain may become chronic. *Psychoneuroendocrinology* **30**, 959–964.
- Saab, C.Y., Park, Y.C., and Al-Chaer, E.D. (2004). Thalamic modulation of visceral nociceptive processing in adult rats with neonatal colon irritation. *Brain Res.* **1008**, 186–192.
- Sachs, D., Cunha, F.Q., Poole, S., and Ferreira, S.H. (2002). Tumor necrosis factor- α , interleukin-1 β and interleukin-8 induce persistent mechanical nociceptor hypersensitivity. *Pain* **96**, 89–97.
- Samad, T.A., Moore, K.A., Sapirstein, A., Billet, S., Allchorne, A., Poole, S., Bonventre, J.V., and Woolf, C.J. (2001). Interleukin-1 β -mediated induction of Cox-2 in the CNS contributes to inflammatory pain hypersensitivity. *Nature* **410**, 471–475.
- Sandkuhler, J. (1996). The organization and function of endogenous antinociceptive systems. *Prog. Neurobiol.* **50**, 49–81.
- Sandkuhler, J. (2000). Learning and memory in pain pathways. *Pain* **88**, 113–118.
- Sandkuhler, J. (2007). Understanding LTP in pain pathways. *Mol. Pain* **3**, 9.
- Sandkuhler, J., and Liu, X. (1998). Induction of long term potentiation at spinal synapses by noxious stimulation or nerve injury. *Eur. J. Neurosci.* **10**, 2476–2480.
- Sarkar, S., Woolf, C.J., Hobson, A.R., Thompson, D.G., and Aziz, Q. (2006). Perceptual wind-up in the human oesophagus is enhanced by central sensitisation. *Gut* **55**, 920–925.
- Schmidt, R., Schmelz, M., Forster, C., Ringkamp, M., Torebjork, E., and Handwerker, H. (1995). Novel classes of responsive and unresponsive C nociceptors in human skin. *J. Neurosci.* **15**, 333–341.
- Scholz, J., Broom, D.C., Youn, D.H., Mills, C.D., Kohno, T., Suter, M.R., Moore, K.A., Decosterd, I., Coggeshall, R.E., and Woolf, C.J. (2005). Blocking caspase activity prevents transsynaptic neuronal apoptosis and the loss of inhibition in lamina II of the dorsal horn after peripheral nerve injury. *J. Neurosci.* **25**, 7317–7323.
- Sheets, P.L., Jackson, J.O. II, Waxman, S.G., Dib-Hajj, S.D., and Cummins, T.R. (2007). A Nav1.7 channel mutation associated with hereditary erythromelalgia contributes to neuronal hyperexcitability and displays reduced lidocaine sensitivity. *J. Physiol.* **581**, 1019–1031.
- Sherman, S.M., and Guillery, R.W. (1996). Functional organization of thalamocortical relays. *J. Neurophysiol.* **76**, 1367–1395.
- Sherman, S.M., and Guillery, R.W. (2002). The role of the thalamus in the flow of information to the cortex. *Philos. Trans. R. Soc. Lond. B Biol. Sci.* **357**, 1695–1708.
- Shi, T.S., Winzer-Serhan, U., Leslie, F., and Hokfelt, T. (2000). Distribution and regulation of $\alpha(2)$ -adrenoceptors in rat dorsal root ganglia. *Pain* **84**, 319–330.
- Shimada, C., Kurumiya, S., Noguchi, Y., and Umemoto, M. (1990). The effect of neonatal exposure to chronic footshock on pain-responsiveness and sensitivity to morphine after maturation in the rat. *Behav. Brain Res.* **36**, 105–111.
- Shinal, R.M., and Fillingim, R.B. (2007). Overview of orofacial pain: Epidemiology and gender differences in orofacial pain. *Dent. Clin. North Am.* **51**, 1–18, v.
- Sivilotti, L.G., Thompson, S.W., and Woolf, C.J. (1993). Rate of rise of the cumulative depolarization evoked by repetitive stimulation of small-caliber afferents is a predictor of action potential windup in rat spinal neurons in vitro. *J. Neurophysiol.* **69**, 1621–1631.
- Sjogren, S., and Wright, B. (1972). Circulatory changes during continuous epidural blockade. *Acta Anaesthesiol. Scand. Suppl.* **46**, 5–25.
- Smith, L.J., Shih, A., Miletic, G., and Miletic, V. (2002). Continual systemic infusion of lidocaine provides analgesia in an animal model of neuropathic pain. *Pain* **97**, 267–273.
- Solak, O., Turna, A., Pekcolaklar, A., Metin, M., Sayar, A., and Gurses, A. (2007). Transcutaneous electric nerve stimulation for the treatment of post-thoracotomy pain: A randomized prospective study. *Thorac. Cardiovasc. Surg.* **55**, 182–185.
- Song, I., and Huganir, R.L. (2002). Regulation of AMPA receptors during synaptic plasticity. *Trends Neurosci.* **25**, 578–588.
- Sonohata, M., Furue, H., Katafuchi, T., Yasaka, T., Doi, A., Kumamoto, E., and Yoshimura, M. (2004). Actions of noradrenaline on substantia gelatinosa neurones in the rat spinal cord revealed by in vivo patch recording. *J. Physiol.* **555**, 515–526.
- Sorkin, L.S., Ferrington, D.G., and Willis, W.D., Jr. (1986). Somatotopic organization and response characteristics of dorsal horn neurons in the cervical spinal cord of the cat. *Somatosens. Res.* **3**, 323–238.
- Sotgiu, M.L., and Biella, G. (2000). Contribution of central sensitization to the pain-related abnormal activity in neuropathic rats. *Somatosens. Mot. Res.* **17**, 32–38.
- Sternberg, W.F., Scorr, L., Smith, L.D., Ridgway, C.G., and Stout, M. (2005). Long-term effects of neonatal surgery on adulthood pain behavior. *Pain* **113**, 347–353.
- Sud, R., Ignatowski, T.A., Lo, C.P., and Spengler, R.N. (2006). Uncovering molecular elements of brain-body communication during development and treatment of neuropathic pain. *Brain Behav. Immun.*
- Suzuki, R., Rahman, W., Rygh, L.J., Webber, M., Hunt, S.P., and Dickenson, A.H. (2005). Spinal-supraspinal serotonergic circuits regulating neuropathic pain and its treatment with gabapentin. *Pain* **117**, 292–303.
- Szolcsanyi, J. (1988). Antidromic vasodilatation and neurogenic inflammation. *Agents Actions* **23**, 4–11.
- Tanaka, M., Cummins, T.R., Ishikawa, K., Dib-Hajj, S.D., Black, J.A., and Waxman, S.G. (1998). SNS Na⁺ channel expression increases in dorsal root ganglion neurons in the carrageenan inflammatory pain model. *Neuroreport* **9**, 967–972.
- Tanga, F.Y., Raghavendra, V., and DeLeo, J.A. (2004). Quantitative real-time RT-PCR assessment of spinal microglial and astrocytic activation markers in a rat model of neuropathic pain. *Neurochem. Int. Glial Biol.: Func. Interact. Glia Neurons* **45**, 397–407.
- Tate, S., Benn, S., Hick, C., Trezise, D., John, V., Mannion, R.J., Costigan, M., Plumptre, C., Grose, D., Gladwell, Z., Kendall, G., Dale, K., Bountra, C., and Woolf, C.J. (1998). Two sodium channels contribute to the TTX-R sodium current in primary sensory neurons. *Nat. Neurosci.* **1**, 653–655.
- Tawfik, V.L., Nutile-McMenemy, N., Lacroix-Fralish, M.L., and DeLeo, J.A. (2007). Efficacy of propentofylline, a glial modulating agent, on existing mechanical allodynia following peripheral nerve injury. *Brain Behav. Immun.* **21**, 238–246.
- Teng, C.J., and Abbott, F.V. (1998). The formalin test: A dose-response analysis at three developmental stages. *Pain* **76**, 337–347.
- Thompson, T., Keogh, E., French, C.C., and Davis, R. (2007). Anxiety sensitivity and pain: Generalisability across noxious stimuli. *Pain*.
- Toge, T., Hirai, T., Takiyama, W., and Hattori, T. (1981). Effects of surgical stress on natural killer activity, proliferative response of spleen cells and cytostatic activity of lung macrophages in rats. *Gann* **72**, 790–794.
- Treede, R.D. (1998). Pathophysiology and diagnosis in patients with sympathetically dependent pain. *Schmerz* **12**, 250–260.
- Ueda, H. (2006). Molecular mechanisms of neuropathic pain-phenotypic switch and initiation mechanisms. *Pharmacol. Ther.* **109**, 57–77.
- Urch, C.E., Donovan-Rodriguez, T., and Dickenson, A.H. (2003). Alterations in dorsal horn neurones in a rat model of cancer-induced bone pain. *Pain* **106**, 347–356.
- Van de Kar, L.D., and Blair, M.L. (1999). Forebrain pathways mediating stress-induced hormone secretion. *Front. Neuroendocrinol.* **20**, 1–48.
- Vanegas, H., and Schaible, H.G. (2004). Descending control of persistent pain: Inhibitory or facilitatory? *Brain Res. Brain Res. Rev.* **46**, 295–309.
- van Praag, H., and Frenk, H. (1991). The development of stimulation-produced analgesia (SPA) in the rat. *Brain Res. Dev. Brain Res.* **64**, 71–76.
- Vaughan, C.W., Ingram, S.L., Connor, M.A., and Christie, M.J. (1997). How opioids inhibit GABA-mediated neurotransmission. *Nature* **390**, 611–614.
- Vazquez, E., Hernandez, N., Escobar, W., and Vanegas, H. (2005). Antinociception induced by intravenous dipyrone (metamizol) upon dorsal horn

- neurons: Involvement of endogenous opioids at the periaqueductal gray matter, the nucleus raphe magnus, and the spinal cord in rats. *Brain Res.* **1048**, 211–217.
- Vesal, N., Cribb, P.H., and Frketic, M. (1996). Postoperative analgesic and cardiopulmonary effects in dogs of oxymorphone administered epidurally and intramuscularly, and medetomidine administered epidurally: A comparative clinical study. *Vet. Surg.* **25**, 361–369.
- Vik-Mo, H., Ottesen, S., and Renck, H. (1978). Cardiac effects of thoracic epidural analgesia before and during acute coronary artery occlusion in open-chest dogs. *Scand. J. Clin. Lab. Invest.* **38**, 737–746.
- Walker, S.M., Meredith-Middleton, J., Cooke-Yarborough, C., and Fitzgerald, M. (2003). Neonatal inflammation and primary afferent terminal plasticity in the rat dorsal horn. *Pain* **105**, 185–195.
- Wang, G., Ji, Y., Lidow, M.S., and Traub, R.J. (2004). Neonatal hind paw injury alters processing of visceral and somatic nociceptive stimuli in the adult rat. *J. Pain* **5**, 440–449.
- Wang, H., Sun, H., Della Penna, K., Benz, R.J., Xu, J., Gerhold, D.L., Holder, D.J., and Koblan, K.S. (2002). Chronic neuropathic pain is accompanied by global changes in gene expression and shares pathobiology with neurodegenerative diseases. *Neuroscience* **114**, 529–546.
- Wang, H., and Woolf, C.J. (2005). Pain TRPs. *Neuron* **46**, 9–12.
- Wang, Q.X., Wang, X.Y., Fu, N.A., Liu, J.Y., and Yao, S.L. (2005). Stellate ganglion block inhibits formalin-induced nociceptive responses: Mechanism of action. *Eur. J. Anaesthesiol.* **22**, 913–918.
- Wang, Y.T., and Salter, M.W. (1994). Regulation of NMDA receptors by tyrosine kinases and phosphatases. *Nature* **369**, 233–235.
- Watkins, L.R., and Maier, S.F. (2002). Beyond neurons: Evidence that immune and glial cells contribute to pathological pain states. *Physiol. Rev.* **82**, 981–1011.
- Watkins, L.R., and Maier, S.F. (2005). Immune regulation of central nervous system functions: From sickness responses to pathological pain. *J. Intern. Med.* **257**, 139–155.
- Watkins, L.R., Milligan, E.D., and Maier, S.F. (2001). Glial activation: A driving force for pathological pain. *Trends Neurosci.* **24**, 450–455.
- Watkins, L.R., Wiertelak, E.P., Goehler, L.E., Smith, K.P., Martin, D., and Maier, S.F. (1994). Characterization of cytokine-induced hyperalgesia. *Brain Res.* **654**, 15–26.
- Waxman, S.G., Cummins, T.R., Dib-Hajj, S.D., and Black, J.A. (2000). Voltage-gated sodium channels and the molecular pathogenesis of pain: A review. *J. Rehabil. Res. Dev.* **37**, 517–528.
- Waxman, S.G., and Hains, B.C. (2006). Fire and phantoms after spinal cord injury: Na^+ channels and central pain. *Trends Neurosci.* **29**, 207–215.
- Westenbroek, R.E., Hell, J.W., Warner, C., Dubel, S.J., Snutch, T.P., and Catterall, W.A. (1992). Biochemical properties and subcellular distribution of an N-type calcium channel $\alpha 1$ subunit. *Neuron* **9**, 1099–1115.
- Westlund, K. (2005). Neurophysiology of nociception. In “The Neurobiological Basis of Pain.” (M. Pappagallo, ed.), pp 4–19. McGraw Hill, New York.
- Whiteside, G.T., and Munglani, R. (2001). Cell death in the superficial dorsal horn in a model of neuropathic pain. *J. Neurosci. Res.* **64**, 168–173.
- Wiedenmayer, C.P., and Barr, G.A. (1998). Ontogeny of defensive behavior and analgesia in rat pups exposed to an adult male rat. *Physiol. Behav.* **63**, 261–269.
- Wieseler-Frank, J., Maier, S.F., and Watkins, L.R. (2004). Glial activation and pathological pain. *Neurochem. Int.* **45**, 389–395.
- Wieseler-Frank, J., Maier, S.F., and Watkins, L.R. (2005a). Central proinflammatory cytokines and pain enhancement. *Neurosignals* **14**, 166–174.
- Wieseler-Frank, J., Maier, S.F., and Watkins, L.R. (2005b). Immune-to-brain communication dynamically modulates pain: Physiological and pathological consequences. *Brain Behav. Immun.* **19**, 104–111.
- Wiesenfeld-Hallin, Z. (2005). Sex differences in pain perception. *Gen. Med.* **2**, 137–145.
- Wiesenfeld-Hallin, Z., and Xu, X.J. (2001). Neuropeptides in neuropathic and inflammatory pain with special emphasis on cholecystokinin and galanin. *Eur. J. Pharmacol.* **429**, 49–59.
- Willis, W.D. (1991). “Sensory Mechanisms of the Spinal Cord.” Plenum Press, New York.
- Willis, W.D. (1999). Dorsal root potentials and dorsal root reflexes: A double-edged sword. *Exp. Brain Res.* **124**, 395–421.
- Willis, W.D., and Coggeshall, R.E. (1991). “Sensory Mechanisms of the Spinal Cord.” Plenum Press, New York.
- Willis, W.D., Kenshalo, D.R., Jr., and Leonard, R.B. (1979). The cells of origin of the primate spinothalamic tract. *J. Comp. Neurol.* **188**, 543–573.
- Willis, W.D., Jr., Zhang, X., Honda, C.N., and Giesler, G.J., Jr. (2002). A critical review of the role of the proposed VMpo nucleus in pain. *J. Pain* **3**, 79–94.
- Woolf, C.J. (1996). Phenotypic modification of primary sensory neurons: The role of nerve growth factor in the production of persistent pain. *Philos. Trans. R. Soc. Lond. B Biol. Sci.* **351**, 441–448.
- Woolf, C.J. (2004). Pain: Moving from symptom control toward mechanism-specific pharmacologic management. *Ann. Intern. Med.* **140**, 441–451.
- Woolf, C.J., and Costigan, M. (1999). Transcriptional and posttranslational plasticity and the generation of inflammatory pain. *Proc. Natl. Acad. Sci. U.S.A.* **96**, 7723–7730.
- Woolf, C.J., and Fitzgerald, M. (1983). The properties of neurons recorded in the superficial dorsal horn of the rat spinal cord. *J. Comp. Neurol.* **221**, 313–328.
- Woolf, C.J., and King, A.E. (1990). Dynamic alterations in the cutaneous mechanoreceptive fields of dorsal horn neurons in the rat spinal cord. *J. Neurosci.* **10**, 2717–2726.
- Woolf, C.J., and Salter, M.W. (2000). Neuronal plasticity: Increasing the gain in pain. *Science* **288**, 1765–1769.
- Woolf, C.J., and Thompson, S.W. (1991). The induction and maintenance of central sensitization is dependent on N-methyl-D-aspartic acid receptor activation: Implications for the treatment of post-injury pain hypersensitivity states. *Pain* **44**, 293–299.
- Wu, L.J., Ko, S.W., and Zhuo, M. (2007). Kainate receptors and pain: From dorsal root ganglion to the anterior cingulate cortex. *Curr. Pharm. Des.* **13**, 1597–1605.
- Xie, W., Strong, J.A., Meij, J.T., Zhang, J.M., and Yu, L. (2005). Neuropathic pain: Early spontaneous afferent activity is the trigger. *Pain* **116**, 243–256.
- Yaksh, T.L., Hua, X.-Y., Kalcheva, I., Nozaki-Taguchi, N., and Marsala, M. (1999). The spinal biology in humans and animals of pain states generated by persistent small afferent input. *PNAS* **96**, 7680–7686.
- Yeager, M.P., Glass, D.D., Neff, R.K., and Brinck-Johnsen, T. (1987). Epidural anesthesia and analgesia in high-risk surgical patients. *Anesthesiology* **66**, 729–736.
- Yen, L.D., Bennett, G.J., and Ribeiro-da-Silva, A. (2006). Sympathetic sprouting and changes in nociceptive sensory innervation in the glabrous skin of the rat hind paw following partial peripheral nerve injury. *J. Comp. Neurol.* **495**, 679–690.
- Yokoyama, K., Kurihara, T., Makita, K., and Tanabe, T. (2003). Plastic change of N-type Ca channel expression after preconditioning is responsible for prostaglandin E2-induced long-lasting allodynia. *Anesthesiology* **99**, 1364–1370.
- Yoshimura, M., and Furue, H. (2006). Mechanisms for the anti-nociceptive actions of the descending noradrenergic and serotonergic systems in the spinal cord. *J. Pharmacol. Sci.* **101**, 107–117.
- Yoshimura, M., Furue, H., Nakatsuka, T., Matayoshi, T., and Katafuchi, T. (2004). Functional reorganization of the spinal pain pathways in developmental and pathological conditions. *Novartis. Found. Symp.* **261**, 116–124; discussion 124–131, 149–154.
- Yu, L.C., and Han, J.S. (1989). Involvement of arcuate nucleus of hypothalamus in the descending pathway from nucleus accumbens to periaqueductal grey subserving an antinociceptive effect. *Int. J. Neurosci.* **48**, 71–78.
- Yu, X.M., Askalan, R., Keil, G.J. II, and Salter, M.W. (1997). NMDA channel regulation by channel-associated protein tyrosine kinase Src. *Science* **275**, 674–678.

- Yu, X.M., and Salter, M.W. (1998). Gain control of NMDA-receptor currents by intracellular sodium. *Nature* **396**, 469–474.
- Yu, X.M., and Salter, M.W. (1999). Src, a molecular switch governing gain control of synaptic transmission mediated by *N*-methyl-D-aspartate receptors. *Proc. Natl. Acad. Sci. U.S.A.* **96**, 7697–7704.
- Zamponi, G.W. (2003). Regulation of presynaptic calcium channels by synaptic proteins. *J. Pharmacol. Sci.* **92**, 79–83.
- Zhang, X., Gokin, A.P., and Giesler, G.J., Jr. (2002). Responses of spinothalamic tract neurons in the thoracic spinal cord of rats to somatic stimuli and to graded distention of the bile duct. *Somatosens. Mot. Res.* **19**, 5–17.
- Zhang, X., Wenk, H.N., Gokin, A.P., Honda, C.N., and Giesler, G.J., Jr. (1999). Physiological studies of spinothalamic tract neurons in the lumbar enlargement of monkeys. *J. Neurophysiol.* **82**, 1054–1058.
- Zhao, M., Li, Q., and Tang, J.S. (2006). The effects of microinjection of morphine into thalamic nucleus submedius on formalin-evoked nociceptive responses of neurons in the rat spinal dorsal horn. *Neurosci. Lett.* **401**, 103–107.
- Zhou, X.F., Chie, E.T., Deng, Y.S., Zhong, J.H., Xue, Q., Rush, R.A., and Xian, C.J. (1999). Injured primary sensory neurons switch phenotype for brain-derived neurotrophic factor in the rat. *Neuroscience* **92**, 841–853.
- Zhuang, Z.Y., Gerner, P., Woolf, C.J., and Ji, R.R. (2005). ERK is sequentially activated in neurons, microglia, and astrocytes by spinal nerve ligation and contributes to mechanical allodynia in this neuropathic pain model. *Pain* **114**, 149–159.

This page intentionally left blank

Chapter 2

Pharmacology of Injectable Anesthetics, Sedatives, and Tranquilizers

Robert E. Meyer and Richard E. Fish

I. Introduction	28
II. Gamma-Aminobutyric Acid Receptor Agonists	29
A. Mechanism of Action	29
B. Barbiturates	30
C. Chloral Hydrate	35
D. Alpha-Chloralose	36
E. Metomidate and Etomidate	37
F. Propofol	38
G. Tribromoethanol	42
H. Steroids	43
I. Benzodiazepine Derivatives	44
III. NMDA-Antagonists	47
A. Mechanism of Action	47
B. Cyclohexamines	47
IV. Alpha2-Adrenoceptor Agonists	50
A. Mechanism of Action and General Description	50
B. Xylazine	52
C. Medetomidine	52
D. Detomidine	53
E. Romifidine	53
F. Alpha2-Adrenoceptor Antagonists	53
V. Dopaminergic Receptor Antagonists	54
A. Mechanism of Action and General Description	54
B. Phenothiazine Derivatives	55
C. Butyrophenone Derivatives	55
VI. Miscellaneous Agents	56
A. Urethane	56
B. Eugenol	59
VII. Local Anesthetics	60
A. Mechanism of Action	60
B. Description	61

C. Biodistribution	61
D. Pharmacologic Effects	62
E. Tissue and Histopathology Effects	63
F. Immune System Effects	64
VIII. Anesthetic Combinations	64
A. Neuroleptanalgesia	64
B. Ketamine Combinations	65
C. Tiletamine–Zolazepam (Telazol)	66
D. Other Anesthetic Combinations	66
References	67

I. INTRODUCTION

The term “injectable anesthetic,” as applied to this chapter covers a broad range of substances with varied effects. The use of injectable anesthetics in laboratory animals is preferred by many for a variety of reasons: ease of administration, a widely available database supporting the use in laboratory animals, fewer specialized equipment needs, avoidance of endotracheal intubation, and fewer potential occupational health concerns for laboratory workers (Fish, 1997). The use of continuous infusion techniques has attracted attention in veterinary and human medicine, not only to account for individual variation, but also to improve anesthetic stability by approaching a steady-state blood concentration (Hedenqvist and Hellebrekers, 2003; Ilkiw and Pascoe, 2003; Ting et al., 2004; White, 1989). There has also been interest in developing injectable anesthetic agents that may approach inhalants in speed of recovery or that have the potential for pharmacologic antagonism (Nunn et al., 1989).

By definition, an injectable anesthetic agent is a compound that by itself produces a state of general anesthesia; this can be further characterized as pharmacologically induced central nervous system (CNS) depression that permits invasive surgical or experimental procedures to be performed. The basic components of general anesthesia include amnesia, unconsciousness, and immobility in response to noxious stimulation. However, many of the agents discussed in this chapter, such as the benzodiazepines, dopaminergic receptor antagonists, and alpha2 adrenergic agonists do not meet the above definition of general anesthetics and generally have adjunctive roles.

Inclusion of analgesia as a necessary component of general anesthesia is arguable (Antognini and Carstens, 2002). Analgesia is the absence of pain, and pain is defined as “an unpleasant sensory and emotional experience associated with actual or potential tissue damage, or described in terms of such damage” (IASP Task Force on Taxonomy, 1994). As such, pain is a conscious experience and analgesia is therefore not an absolutely necessary component of general anesthesia because unconscious animals (or humans) cannot experience pain (Antognini et al., 2005). Many injectable anesthetics, such as the GABA_A agonist propofol, do not routinely produce analgesia (Frolich et al., 2005), yet can produce adequate general anesthesia in humans and animals. Animals administered injectable anesthetics often require supplemental pre- or perioperative analgesic

administration to prevent autonomic or physiologic responses to noxious stimulation; those subjected to extensive or invasive procedures will likely require postoperative analgesics for pain control following return to consciousness.

There is a need while evaluating research literature on anesthetic agents, to consider the importance of recognizing: how (if) the parameters of anesthetic duration are defined, and the distinction between depth of anesthesia and antinociceptive potency (Antognini et al., 2005; Whelan and Flecknell, 1992; Wixson et al., 1987a); shortcomings of control data such as absence of nonmedicated animal data, and use of conscious animals which are restrained, not at rest, or are evaluated shortly after recovery from instrumentation surgery/anesthesia; and failure to maintain normal body temperature and ventilation status. It should also be remembered that, although a pharmacologic effect may be attributed to a particular anesthetic agent, many reported effects are a more generalized feature of the anesthetic state. For example, barbiturate anesthesia has been reported to reduce ionizing radiation effectiveness in killing tumor cells. Although this effect has been attributed to a direct effect on cellular respiration (Aldridge and Parker, 1960), it is instead due to anesthetic-mediated reduction and redistribution of tumor blood flow in anesthetized animals (Meyer et al., 2002).

As a general rule, injectable anesthetics tend to produce drug-specific and dose-dependent circulatory, respiratory, and CNS effects. The mechanisms by which anesthetics exert their systemic effects in the intact animal are modified by their direct and indirect influence on myocardial contractility, peripheral smooth muscle tone, and autonomic nervous system activity. These effects vary substantially among different anesthetics, even at equivalent doses, and can greatly affect physiologic processes as well as the uptake and distribution of concurrently administered pharmaceuticals.

Determining an equivalent dose for injectable anesthetic agents can be quite difficult. In order to make meaningful comparisons of anesthetic effect, including potency and safety, it is essential that equally potent doses of anesthesia are administered under well-defined conditions. Individual anesthetic dose-response curves tend to be quite steep and are not necessarily parallel. Higher doses of hypnotic agents, such as propofol or the barbiturates, do not induce additional antinociception commensurate with increased CNS and cardiopulmonary depression. For inhaled anesthetics, the minimum alveolar

concentration (MAC) provides a quantitative measure of CNS potency based on movement in response to a standardized noxious stimulus; the equivalent for injectable anesthetics would be the free concentration of drug in plasma required to prevent response to noxious stimulus in 50% of subjects, which is a difficult measurement to make in real time.

Injectable anesthetic agents producing adequate anesthesia in one strain or species may be insufficient or may provide different signs of anesthesia at similar doses in other strains or species. There are several possible reasons for this. Anesthetic uptake, distribution, and effect are governed by the pharmacokinetic and pharmacodynamic properties of the anesthetic agent in that strain or species. As is true for other drugs, individual variation plays an important role in biodisposition and pharmacokinetics, as well as in therapeutics. Components of this variation include genotype (breed, stock, strain), sex, age, body composition, and nutritional and disease status.

Allometric scaling is often applied when extrapolating drug disposition across species. Allometric scaling is based on the empirical observation that certain physiological functions, such as renal glomerular filtration rate, oxygen consumption, cardiac output, and basal metabolic rate, can be scaled across species as a function of body size or surface area according to a power function or its log-transformed linear equivalent:

$$Y = aW^b$$

where Y is the parameter under study, a an allometric coefficient (intercept) that is constant for a drug, W the species average body weight, and b the allometric exponent, generally between 0.67 and 1.0 (Adolph, 1949). Although allometry applies well to antibiotics, it appears to be of limited use for most injectable anesthetic drugs. This may be due to factors such as species differences in protein binding, as well as species-dependent differences in "flow-dependent" and "capacity-dependent" hepatic clearances (Riviere et al., 1997).

Abundant, detailed information on the pharmacology of injectable anesthetics is available in both human and veterinary literature. While it is presumed that the cellular mechanisms underlying anesthetic effects are well conserved among species, it is clear that pharmacokinetics (or biodisposition) and clinical effects differ markedly among species. The focus of this chapter, therefore, is on the pharmacologic aspects of injectable agents in experimental animals, with particular emphasis on nondomestic species, and the effects of these agents on the physiology and metabolism of the animal.

II. GAMMA-AMINOBUTYRIC ACID RECEPTOR AGONISTS

A. Mechanism of Action

The barbiturates, chloral hydrate, alpha-chloralose, tribromoethanol (TBE), propofol, metomidate, etomidate, the

steroid anesthetics, and the benzodiazepines all exert sedative and hypnotic effects through interactions with the inhibitory γ -aminobutyric acid (GABA) neurotransmitter system (Im et al., 1990; Krasowski and Harrison, 2000; Macdonald and McLean, 1986; Olsen, 1987; Saunders and Ho, 1990; Stoelting and Hillier, 2006; Suzdak et al., 1986; Turner et al., 1989). Both the GABA and adrenergic neurotransmitter systems act to counterbalance the action of excitatory neurotransmitters. The GABA type A receptor (GABA_A) receptor is comprised of five glycoprotein subunits (α , β , γ 2 subunits). Transmembrane chloride conductance increases when the GABA_A receptor is activated, resulting in postsynaptic cell membrane hyperpolarization and postsynaptic neuron resistance to stimulation by excitatory transmitters. Barbiturates and propofol appear to decrease the rate of dissociation of GABA from its receptor, thus increasing the duration of the GABA-activated opening of chloride channels. Barbiturates also can mimic the action of GABA by activating the chloride channels directly. Etomidate augments GABA-gated chloride currents (indirect modulation), and produces chloride currents in the absence of GABA at higher concentrations (direct modulation). Although propofol, like the barbiturates, enhances GABA-activated chloride channel activity, it also has ion-channel-blocking effects in cerebral cortex and nicotinic acetylcholine receptors, and inhibits lysophosphatidate signaling in lipid mediator receptors. Thus, by acting on a single receptor via different mechanisms, quite different anesthetic agents can act synergistically to increase GABA_A receptor-mediated inhibition of the CNS. The use of GABA_A-targeted mutant knockout and knockin mice has greatly assisted in determining the role of individual receptor subtypes to anesthetic action (Rudolph and Mohler, 2004; Wafford et al., 2004).

The benzodiazepines are unusual, in that they do not directly activate GABA_A receptors, but rather enhance the affinity of the receptors for GABA (Mohler and Richards, 1988); in the absence of GABA, benzodiazepines have no effects on GABA_A receptor function. As a result, there is increased affinity of the GABA receptor for the inhibitory neurotransmitter, which facilitates opening of chloride-gated channels and increases chloride conductance. The subsequent resistance to excitation is presumed to be the mechanism by which benzodiazepines produce anxiolysis, sedation, potentiation of other CNS drug effects, anterograde amnesia, and anticonvulsant and muscle relaxation effects.

The degree of benzodiazepine receptor modulation is limited and may explain the CNS "ceiling effect" observed with these drugs. Greatest binding capacity is found in alpha1 subunits of the GABA_A receptor present in the cerebral cortex, cerebellar cortex, and thalamus (McKernan et al., 2000; Rall, 1990); this is thought to produce sedation, while the less abundant alpha2 subunits present in the limbic system are associated with anxiolysis (Low et al., 2000). The overall pharmacologic effect is modulation of release of excitatory neurotransmitters, such as norepinephrine, dopamine, and serotonin (Muir et al., 1991).

It is important to realize that although GABA_A-agonist injectable anesthetics can produce sedation, hypnosis, and, with the exception of the benzodiazepines, general anesthesia, they are generally considered to be poor analgesics and therefore may be insufficient for extensive or highly invasive surgery. However, even large doses of opioids (covered elsewhere in this text) or alpha2-adrenergic agonists (Section IV) induce an incomplete anesthetic state, and usually require the addition of a hypnotic GABA_A-agonist (or NMDA-antagonist) to cause unconsciousness (Stoelting and Hillier, 2006).

B. Barbiturates

1. Description

Barbiturates are derived from barbituric acid, which itself is nondepressant, but appropriate side-chain substitutions result in CNS depressant activity that varies in potency and duration with carbon chain length, branching, and saturation. Oxybarbiturates retain an oxygen atom on number 2-carbon atom of the barbituric acid ring. Thiobarbiturates replace this oxygen atom with a sulfur atom, which confers greater lipid solubility. Generally speaking, a substitution such as sulfuration that increases lipid solubility is associated with greater hypnotic potency and more rapid onset, but shorter duration of action. Addition of a methyl group to the nitrogen atom of the barbituric acid ring, as with oxybarbiturate methohexital, also results in a compound with a short duration of action.

Classification of barbiturates as long, short, and ultrashort acting is no longer recommended, as it suggests that drug action ends abruptly after specified time periods; residual plasma concentrations and drug effects persist for several hours, even following anesthetic induction with "ultra-short acting" barbiturates (Stoelting and Hillier, 2006). Barbiturates in general are readily absorbed by most sites, including the gastrointestinal tract; however, the highly alkaline pH of some barbiturate solutions limits their administration via the intravenous route.

As with other GABA_A agonists, the barbiturates are generally considered to be good hypnotic agents, but relatively poor analgesics (Booth, 1988a; Tomemori et al., 1981). Barbiturates at low doses may not provide reliable sedation in the presence of pain without supplemental analgesia, such that the barbiturates may be classified as hypnotic sedatives, reflecting their dose-dependent ability to produce either sedation or a deeper hypnotic state (Heavner, 1986). Instead of sedation, paradoxical excitement can occur, especially at low doses or with slow intravenous administration, but this is likely due to barbiturate-induced depression of CNS inhibitory centers. Although hyperalgesic properties have been attributed to the barbiturates, spinal cord analgesic effects can be demonstrated (Jewett et al., 1992), as well as peripheral antihyperalgesia effects in a rat intraplantar formalin injection model (da Motta et al., 2004).

Barbiturate administration is not associated with increased sympathetic activity (Zimpfer et al., 1982). They selectively suppress transmission in sympathetic nervous system ganglia at concentrations that have no detectable effect on nerve conduction. This effect may contribute to decreased systemic blood pressure that is sometimes observed with intravenous (IV) administration of barbiturates or associated with barbiturate overdose. High doses of barbiturates decrease sensitivity of postsynaptic membranes to acetylcholine at the neuromuscular junction.

Barbiturates decrease cerebral blood flow (CBF) and thus decrease intracranial pressure (ICP); cerebral vascular reactivity to carbon dioxide is preserved (Ilkiw, 1992). Although amelioration of neuronal damage through decreased cerebral metabolic rate is provided by barbiturates following a focal ischemic event (Hall and Murdoch, 1990), the ability of barbiturates to improve brain survival after global cerebral ischemia is unlikely, as these drugs are only effective when the EEG remains active and metabolic suppression is possible.

Tolerance to barbiturate effects, due to hepatic NADPH-dependent cytochrome P450 enzyme induction, can be demonstrated following previous exposure to the same or different barbiturate drug. For example, rats treated with phenobarbital and later with hexobarbital were anesthetized only 5% as long as untreated rats (Conney et al., 1960), and pentobarbital plasma half-life following chronic pentobarbital pretreatment was only 12% that of control rats (Commissaris et al., 1982). Chronic exposure to barbiturates, particularly phenobarbital and pentobarbital, has been associated with induction of cytochrome P450 2B monooxygenase activity and implicated in hepatic tumor carcinogenesis in male F344/NCr rats initiated with *N*-nitrosodiethylamine (Rice et al., 1994). In contrast to tolerance phenomena, drugs which suppress hepatic microsomal enzyme function may prolong barbiturate effect. The antibiotic chloramphenicol prolongs pentobarbital anesthesia in the rat, mouse, dog, cat, and monkey (Adams, 1970; Adams and Dixit, 1970; Azadegan et al., 1980; Teske and Carter, 1971).

Species differences in barbiturate response are directly related to pharmacokinetics rather than differences in drug receptor sensitivity (Davis et al., 1973; Dos Santos and Bogan, 1974). For example, pentobarbital half-life is 38, 85, 100, and 200 minutes in the mouse, rabbit, rat, and dog, respectively (Thurmon, 1985), and thiopental elimination half-life and steady-state volume of distribution in the rabbit are markedly lower than those in the dog or sheep (Ilkiw et al., 1991). Differences in plasma protein binding of barbiturates may contribute to both species and individual differences in drug disposition (Sharma et al., 1970; Thurmon, 1985).

Barbiturates selectively inhibit glucose transport by some, but not all, facilitative glucose transporter isoforms in cultured mammalian cells, human erythrocytes, and across the blood-brain barrier (Haspel et al., 1999); these effects are pharmacologically specific and isoform-specific. Barbiturate inhibition of the glucose transporter can be antagonized by

thyroid-releasing hormone (Naftalin et al., 2004). On the other hand, glucose administration to animals recovering from barbiturate anesthesia can result in reanesthetization. This "glucose effect" can also be induced by fructose, lactate, pyruvate, and glutamate (Booth, 1988a; Lumb and Jones, 1984); a similar reanesthetization effect may occur with the administration of adrenergic agents (Heavner and Bowen, 1968; Lamson et al., 1952). The glucose effect is of limited practical concern when these agents are administered properly (Hatch, 1966).

2. *Thiopental, Thiamylal, and Methohexital*

Thiamylal, thiopental, and methohexital are generally administered intravenously to larger laboratory animals. These agents are supplied as highly alkaline sodium salts that are soluble in water or saline (the pH of a 2.5% solution of thiopental is 10.5). Commercial barbiturate preparations contain added anhydrous sodium carbonate to prevent precipitation of the insoluble acid form of the barbiturate by atmospheric carbon dioxide. These alkaline solutions are incompatible with acidic drugs such as opioids, catecholamines, and neuromuscular blocking agents. The powder form of thiopental is stable at room temperature for an indefinite period of time; reconstituted solutions of thiopental are stable and sterile for at least 6 days at room temperature (Haws et al., 1998); refrigerated solutions of thiobarbiturates are stable for up to 2 weeks while refrigerated solutions of methohexital are stable for up to 6 weeks. Thiobarbiturates are commercially marketed as racemic mixtures and the *S*(-) isomers are twice as potent as the *R*(+) isomers. Similarly, methohexital is a racemic mixture of the *S*(-) and *R*(+) isomers. Although the *S*(-) isomer of methohexital is four to five times more potent than the *R*(+) isomer, the *S*(-) isomer is responsible for the excessive skeletal muscle activity that accompanies methohexital use. These agents rapidly pass the blood-brain barrier due to their high lipid solubility and result in a rapid onset of action compared to less lipid-soluble barbiturates (Booth, 1988a).

Pharmacokinetics of thiamylal were determined after 13.2 mg/kg body weight was administered IV to cats. Disposition of thiamylal best conformed to two multicompartmental models, a 2-compartment and a 3-compartment open pharmacokinetic model. The first or rapid distribution half-life was 1.91 minutes and a second, or slower, distribution half-life was 26.5 minutes. The elimination half-life was 14.3 hours. The apparent volume of distribution was 3.61 L/kg, whereas the apparent volume of the central compartment was 0.46 L/kg; total clearance was 0.135 L/kg/h (Wertz et al., 1988).

Thiobarbiturates tend to cause dose-dependent suppression of ventilation. In dogs, thiopental decreases the hypercapnic and hypoxic drive of respiration, and attenuates carbon dioxide augmentation of the hypoxic response (Hirshman et al., 1975). In rabbits, thiopental results in hypercapnia with decreased minute volume and respiratory rate (Bellman and Pleuvry, 1981).

Regain of consciousness with these agents is due primarily to redistribution via blood flow away from CNS to other tissues. With large or repeated doses, recovery becomes prolonged, as drug initially sequestered in fat and skeletal muscle reenters the circulation due to equilibration between blood and tissues (Booth, 1988a). Thiobarbiturates are extensively protein-bound, mainly to albumin. Decreased protein binding due to hypoproteinemia or displacement by other drugs, such as aspirin or phenylbutazone, can lead to enhanced thiobarbiturate effect. Distribution of thiobarbiturates between blood and tissues is also influenced by the ionization state of the drug and subsequent binding to plasma proteins: such that acidosis increases and alkalosis decreases thiobarbiturate effect. The duration of action is also affected by the speed of injection. Bolus administration resulting in high plasma levels produces a relatively greater fraction of unbound drug (Kurz and Fichtl, 1981). Thiobarbiturates act preferentially in the reticular activating system, suppressing polysynaptic pathways in higher brain centers (Muir et al., 1991). An excitement phase is commonly observed during a slow IV anesthetic induction, likely due to depression of CNS inhibitory centers, especially in large animals (Booth, 1988a).

Unlike return to consciousness, thiobarbiturate elimination depends almost entirely on metabolism. Thiobarbiturates are metabolized primarily in the (Booth, 1988a). These metabolites are inactive and more water soluble, facilitating renal excretion. The initial step in metabolism, which occurs within the hepatocyte endoplasmic reticulum, is side-chain oxidation at the number 5 carbon atom of the benzene ring, yielding carboxylic acid. Hepatic reserve capacity for oxidation of barbiturates is quite large, such that hepatic dysfunction is extreme before barbiturate activity is prolonged due to decreased metabolism. Methohexital is metabolized three to four times more rapidly than the thiobarbiturates; its lower lipid solubility allows more drug to remain within the circulation and thus be available for metabolism.

The arrhythmogenic potential of thiobarbiturates is well accepted (Booth, 1988a; Hayashi et al., 1989; Lumb and Jones, 1984), but there is little information on comparative aspects of this effect in different species. Sinus tachycardia, bigeminy, ventricular escape rhythm, ventricular tachycardia, and ventricular fibrillation have all been observed following administration of small doses of epinephrine in both awake dogs and dogs anesthetized with thiamylal (Muir et al., 1975). Constantly coupled ventricular bigeminy observed with thiobarbiturate bolus injection appears to be due to an autonomic imbalance between parasympathetic and sympathetic efferent activity (Muir, 1977).

Thiamylal anesthesia in the rabbit has little effect on the cardiovascular response to bilateral carotid artery occlusion or mild hemorrhage (Yamazaki and Sagawa, 1984). Myocardial contractility is impaired with thiopental exposure in the paced, isolated guinea pig heart and isolated rabbit ventricular myocardium preparation (Frankl and Poole-Wilson, 1981; Stowe et al., 1992). Barbiturates alter the contractility of isolated

mesenteric lymphatics and vascular smooth muscle, apparently by interfering with calcium-dependent processes (Altura and Altura, 1975; Altura et al., 1980; McHale and Thornbury, 1989). Thiopental inhibits rat atrial and portal vein contractions in vitro (Bunting et al., 1989).

Ischemic preconditioning, where brief ischemic episodes are followed by periods of reperfusion, increases resistance to further ischemic tissue damage. Pharmacological preconditioning can be induced by volatile anesthetics and opioids. Anesthetic-induced preconditioning and ischemic preconditioning share many fundamental steps, including activation of G-protein-coupled receptors, multiple protein kinases, and ATP-sensitive potassium channels (K_{ATP}); the opening of K_{ATP} channels ultimately elicits cytoprotection by decreasing cytosolic and mitochondrial Ca^{++} overload. In isolated rat hearts subjected to 30 minutes of global no-flow ischemia followed by 60 minutes of reperfusion, recovery of left ventricular-developed pressure was improved by ischemic preconditioning compared with the control group; this improvement of myocardial function was not altered by thiopental, implying that thiopental does not block the cardioprotective effects of ischemic preconditioning (Mullenheim et al., 2001a). On the other hand, in a cellular model of simulated ischemia, diazoxide-induced cell protection of mitochondrial K_{ATP} channel activity was reduced by thiopental and pentobarbital (Zaugg et al., 2002).

3. Thiobutabarbital

Although Inactin, the product name for ethyl-(1-methyl-propyl) malonyl-thiourea (also referred to as thiobutabarbital, or EMTU), is no longer available, it continues to be popular for its prolonged and stable anesthetic state in rats for renal studies (Buelke-Sam et al., 1978; Cupples et al., 1982; Rieg et al., 2004; Turner and Howards, 1977). In rats, thiobutabarbital decreases arterial pressure, renal blood flow and glomerular filtration rate (Walker et al., 1983); renal and single nephron function during thiobutabarbital and thiopental anesthesia were judged to be similar (100 mg/kg intraperitoneal (IP) for each agent) (Haberle et al., 1993). In rabbits, however, thiobutabarbital is ineffective, and results in both short periods of anesthesia and death (Hobbs et al., 1991). Reagent-grade thiobutabarbital can be obtained from chemical suppliers such as Sigma-Aldrich.

4. Pentobarbital

The oxybarbiturate pentobarbital continues to be used to produce rodent anesthesia. The use of pentobarbital stems from its generalized availability, modest cost, widely available database encompassing decades of use, rapid anesthetic onset, nonirritant nature, and ease of IP injection to rodents of varying ages and body weights (Wixson and Smiler, 1997). Pentobarbital provides inadequate or inconsistent analgesia in mice (Erhardt et al., 1984), rats (Wixson et al., 1987b), and rabbits (Borkowski et al., 1990). It is not associated with a rise in plasma beta-endorphins,

in contrast to significant increases following administration of fentanyl-fluanisone, urethane, and ether (Ramirez-Gonzalez et al., 1991). IP administration of pentobarbital in rats is associated with mild excitement both on induction and on recovery (Wixson et al., 1987a).

Commercial preparations of pentobarbital are racemic mixtures. The (+) isomer causes a transient period of hyperexcitability before CNS depression, while the (−) isomer produces relatively smooth and progressively deeper hypnosis (Huang and Barker, 1980). At anesthetic doses, pentobarbital suppresses high-frequency neuronal firing by inhibiting voltage-dependent Na^+ channels; higher doses reduce voltage-dependent K^+ conductances (Hardman et al., 1996). Pentobarbital is metabolized primarily by hepatic cytochrome P450 microsomal enzymes and hydroxylation of the 3-carbon methylbutyl side chain (Freudenthal and Carroll, 1973). In sheep, excretion via routes other than urine is negligible (Dos Santos and Bogan, 1974), in contrast to the rat, in which 28% of a dose is excreted in bile within 6 hours (Klaassen, 1971).

a. Route of Administration and Cardiovascular Effects

Pentobarbital can be administered either intravenously or intraperitoneally. Reduced blood pressure, stroke volume, pulse pressure, and central venous pressure are common findings in pentobarbital-anesthetized animals (Parker and Adams, 1978). Although pentobarbital is reported to produce prolonged hypotension in the rat (Svendson and Carter, 1985; Wixson et al., 1987c), other investigators have reported an increased arterial pressure (Folle and Levesque, 1976). Cardiac output in the rat is reduced (Gumbleton et al., 1990a; Kawaue and Iriuchijima, 1984; Lee et al., 1985; Seyde et al., 1985), and cardiovascular reflex responses are altered (Aisaka et al., 1991; Fluckiger et al., 1985; Wang et al., 1991). Kawaue and Iriuchijima (1984) examined the effect of 30 mg/kg IV pentobarbital in rats chronically implanted with electromagnetic flow probes. IV administration was initially associated with an acute decrease in blood pressure, from 105 to 75 mmHg, with recovery to 90 mmHg during the next 30 minutes. Cardiac output gradually decreased 30% by 30 minutes; hindquarter blood flow decreased 25%, and splanchnic blood flow initially increased 40% then recovered to baseline by 30 minutes. Myocardial contractility is impaired following pentobarbital anesthesia in the dog (Vatner et al., 1971), been demonstrated in vitro (Parker and Adams, 1978).

The cardiovascular effects of pentobarbital are less pronounced following IP administration. Peak blood concentration is reached more slowly than with IV injection, and the portion of drug absorbed into the portal system is subject to early metabolism in the liver. Tuma et al. (1985) examined the cardiovascular and tissue perfusion effects of 35 mg/kg IP pentobarbital in 12-month-old female Fischer 344 rats. Compared with awake controls, IP injection increased mean arterial blood pressure to 130 mmHg (awake control 114 mmHg) while

cardiac output decreased nonsignificantly. Renal perfusion was maintained at awake levels; however, blood flow to most organs decreased from awake levels, with the exception of the liver. Skeletal muscle blood flow showed the greatest decrease, with a four to sixfold reduction from the awake state (to 3 ml/min/100 g, awake control 18 ml/min/100 g). Similar results were described by Skolleborg et al. (1990) for cardiac output and organ blood flow following administration of 50 mg/kg pentobarbital in Mol:WIST male rats.

Taie et al. (1999) reported stable mean arterial pressures centered around 100 mmHg during a 90 minute observation period in male Sprague-Dawley rats anesthetized with 40 mg/kg IP pentobarbital; a dose of 80 mg/kg reduced mean arterial pressure to around 90 mmHg, which was also stable during a 180 minute observation period. In contrast, Wixson et al. (1987c) found that IP injections of 30 and 40 mg/kg pentobarbital in male Sprague-Dawley rats resulted in sustained MAP decreases of about 20% (30 mmHg). The lower dose of pentobarbital showed minimal effect on heart rate, while the 40 mg/kg dose decreased heart rate by 9.2% initially with mild tachycardia at later times.

In SvEv/Tac mice, 50 mg/kg IP pentobarbital reduced heart rate, from 658 beats/min (awake) to 377 beats/min, and reduced cardiac output, from 13 to 8.6 ml/min/g. In comparison, 15/150 mg/kg xylazine/ketamine IP produced greater reduction in heart rate and cardiac output, to 293 beats/min and 7.2 ml/min/g (Yang et al., 1999). At a dose of 50 mg/kg, which was insufficient to induce surgical-level anesthesia, pentobarbital reduced MAP in male adult BALB/c mice from 129 to 107 mmHg and reduced heart rate from 509 to 228 beats/min (Erhardt et al., 1984). Respiratory rate was also depressed, decreasing from 195 to 71 breaths/min.

Pentobarbital anesthesia in the dog typically increases heart rate (Booth, 1988a; Manders and Vatner, 1976). Heart rate in pentobarbital-anesthetized rats (Wixson et al., 1987c) and rabbits (Borkowski et al., 1990; Flecknell et al., 1983) is not significantly altered, although tachycardia is seen in rabbits with subanesthetic doses (Murthy et al., 1982). Increased heart rate observed with barbiturates is not due to increased sympathetic activity (Zimpfer et al., 1982).

Pharmacologic activation of adenosine triphosphate-regulated K_{ATP} channels mimics ischemic myocardial preconditioning, and may decrease infarct size and improve functional recovery of ischemic-reperfused stunned myocardium. Pentobarbital inhibits the ischemic preconditioning-like cardioprotective effect of inhalational anesthetics (Kohro et al., 2001). In a cellular model of simulated myocardial ischemia, diazoxide-induced cell protection of mitochondrial K_{ATP} channel activity was blocked by pentobarbital (Zaugg et al., 2002).

b. Effect on Ventilation and Blood Gases

Pentobarbital can be a potent dose-dependent ventilatory depressant. Respiratory depression is reported in the rat (Folle and Levesque, 1976; Seyde et al., 1985; Svendsen and Carter,

1985; Wixson et al., 1987c), mouse (Erhardt et al., 1984), rabbit (Borkowski et al., 1990; Flecknell et al., 1983), and hamster (Reid et al., 1989). In the dog, pentobarbital decreases hypercapnic and hypoxic drive of respiration, and attenuates carbon dioxide augmentation of the hypoxic response (Hirshman et al., 1975). Wixson et al. (1987c) reported that 40 mg/kg pentobarbital administered IP to male Sprague-Dawley rats decreased pH by 1.2% or 0.09–0.10 pH units, and increased PaCO₂ by 46% (11 mmHg); 30 and 40 mg/kg pentobarbital decreased PaO₂ by 19–20% (34 mmHg). Even at doses insufficient to produce antinociception, similar ventilatory effects were observed in mice (Erhardt et al., 1984): pentobarbital (50 mg/kg IP) in male adult BALB/c mice decreased arterial pH almost 0.15 units, from 7.285 to 7.137, while arterial PCO₂ increased from 26.5 to 38.8 mmHg and PaO₂ dropped from 111.7 to 93.0 mmHg.

In contrast, Skolleborg et al. (1990) reported arterial blood gas values for pH, PCO₂ and PO₂ within the normal awake range in male Mol:WIST rats following administration of 50 mg/kg IP pentobarbital. Similar findings of minimal respiratory depression have been reported for female Fischer 344 rats anesthetized with 50 mg/kg IP pentobarbital (Dewhirst et al., 1996) and for male Sprague-Dawley rats anesthetized with 40 mg/kg IP pentobarbital (Taie et al., 1999). It has been speculated that these respiratory effects may have been due to maintenance of body temperature (Collado et al., 1987; Heys et al., 1989).

c. Tolerance and Strain Differences

Barbiturate sleep time in rats and mice has been used in pharmacologic and toxicologic studies as a noninvasive measure of liver function. Although pentobarbital blood levels also decrease, in part, due to redistribution (Thurmon, 1985), sleep time is inversely proportional to the rate of drug metabolism (Lovell, 1986b). A variety of factors affect sleep time, including age, sex, strain, feed and nutritional status, bedding material, and temperature (Collins and Lott, 1968; Cunliffe-Beamer et al., 1981; Hall et al., 1976; Jondorff et al., 1958; Lovell, 1986a–c; Quinn et al., 1958; Taber and Irwin, 1969; Vesell, 1968; Westenberg and Bolam, 1981; Westfall et al., 1964). Sleep time can be prolonged by administration of sulfonamides, salicylates, doxycycline, and phenylbutazone, each of which acts by displacing barbiturates from serum protein-binding sites (Booth, 1988a; Chaplin et al., 1973). At doses of 30–55 mg/kg, female rats take three times longer to recover than males, and mortality is higher in the females (Holck et al., 1937).

There are large differences in pentobarbital dose-response among strains of mice, such that underdosage or overdosage frequently occurs. A dose of 50 mg/kg provided adequate sedation, but insufficient analgesia in male adult BALB/c mice (Erhardt et al., 1984); some mortality was noted at doses of 60 mg/kg, indicating a narrow safety margin. Lovell studied the effects of 60 mg/kg pentobarbital administered IP to 23 strains of inbred mice (Lovell, 1986a–1986c). The variation

in sleep time among strains of mice is considerable, ranging from 50 minutes for female NZW mice to 250 minutes for male dibromoacetaldehyde (DBA) mice. Male mice generally sleep longer than female mice. C57BL/6 mice sleep longer than CBA mice, which sleep longer than BALB/c mice. There are also within-strain differences for age, sex, litter size, and fasting prior to anesthesia. Environmental variables affecting sleep time include diet, environmental temperature, and bedding material, with inbred strains showing greater variation than F1 hybrids. At an environmental temperature of 18°C, sleep time in BALB/c mice administered 60 mg/kg pentobarbital IP is 195 minutes, and raising environmental temperature to 26°C decreases sleep time to 100 minutes. However, at an environmental temperature of 18°C, C57BL/10ScSn mice sleep over 400 minutes. It is likely that strain and environmental factors have contributed to the confusion surrounding anesthetic effect on tumor physiology and radiotherapy outcome (Meyer et al., 2002).

5. *Immune System Effects*

The *in vitro* anti-inflammatory effects of anesthetics have been reviewed by Schneemilch et al. (2004).

Thiopental directly inhibits cell-mediated immune response and has a strong anti-inflammatory effect. Long-term administration of high doses of thiopental is associated with increased nosocomial infection and mortality, possibly due to inhibition of nuclear transcription factor kappaB, which is a central regulator of the immune response (Loop et al., 2002). Bone marrow suppression and leukopenia are reported following long-term thiopental administration to treat increased ICP in human patients. At clinically used concentrations, thiopental has been shown to inhibit the bactericidal functions of leukocytes as well as polarization, chemotaxis, adherence, phagocytosis, and the respiratory burst of neutrophils and chemotaxis of monocytes, while at high concentrations, thiopental affects neutrophil and monocyte phagocytosis.

Thiopental impairs neutrophil function at clinically relevant concentrations (Nishina et al., 1998). In normothermic Fischer 344 rats, thiopental anesthesia (70 mg/kg IP) reduced natural killer cell activity to 40% of the control value (Ben-Eliyahu et al., 1999). These changes were not accompanied by alterations in the numbers of circulating natural killer cells. Barbiturates decrease leukocyte counts in dogs (Usenik and Cronkite, 1965), and cause profound and prolonged decrease of lymphocytes in the sheep lymphocyte traffic model, where efferent and afferent lymphatic vessels from a single peripheral lymph node are cannulated for study of cells and substances (Hall and Morris, 1962). Thiopental depresses lymphocyte proliferation due to mitogen/antigen exposure and decreases the quantity of cytokines released. Pentobarbital causes injury to lymphocytes and to hepatic Kupffer and endothelial cells in ICR mice within 6 hours of administration, as indicated by elevated hepatic aspartate transferase and alanine transaminase levels (Thompson et al., 2002). On the other hand, spontaneous leukocyte

rolling in postcapillary venules is not affected by pentobarbital (Janssen et al., 1997).

Lipopolysaccharide (LPS) administration to animals under anesthesia is often used to study proinflammatory cytokine release. Thiopental inhibits endotoxin-induced production of tumor necrosis factor (TNF α), IL-1 and IL-8 and increases IL-10 release *in vitro* (Taniguchi and Yamamoto, 2005). In adult male HsdBrl:WH Wistar rats, pentobarbital enhances basal expression of IL-1 β and IL-6 mRNA in rat spleen; TNF α mRNA is unaffected (Bette et al., 2004). In C57BL/6 mice anesthetized with 90 mg/kg pentobarbital IP, 40 mg/kg LPS causes endotoxemia and results in hypoglycemia and increased serum alanine aminotransferase, lipase, and creatinine levels, suggesting LPS damage to the liver, exocrine pancreas, and kidney (Kazerani and Furman, 2006). Importantly, lung myeloperoxidase activity, an indicator of neutrophil infiltration, is also increased by LPS, implying that pentobarbital does not protect mice against LPS-mediated damage to the lung and is a suitable anesthetic for studies of endotoxemia (Kazerani and Furman, 2006). In contrast, Yang et al. (2007) report pentobarbital suppression of LPS-induced TNF α mRNA, possibly due to decreased nuclear factor kappaB and activator protein 1 and reduced expression of p38 mitogen-activated protein kinase; these authors conclude pentobarbital protects cells from death directly and indirectly induced by TNF α during the LPS-induced inflammatory response.

Pentobarbital enhances *in vitro* GABA-inhibition of anti-CD3 and antigen-specific T cell proliferation in a dose-dependent manner (Tian et al., 1999). Unlike halothane, methoxyflurane, and ketamine/xylazine, pentobarbital decreases *in vivo* antibody levels in male Holtzman Sprague-Dawley rats even 3 weeks after exposure; surgery does not produce larger changes in antibody levels than anesthesia itself (Lockwood et al., 1993).

6. *Other Pharmacologic Effects*

Other reported pharmacologic effects of the barbiturates include the following: progressive decrease in core temperature in rats (Commissaris et al., 1982; Wixson et al., 1987d) and mice (Johnson et al., 1976); decreased renal blood flow and urine output, secondary to lowered blood pressure (Booth, 1988a); increased sensitivity to barbiturate anesthesia in uremia, probably due to reduced protein binding (Booth, 1988a); reduced renal blood flow and glomerular filtration rate in rats (Gumbleton et al., 1990a; Walker et al., 1986), apparently responsible for decreased elimination rate of aminoglycoside antibiotics (Higashi et al., 1982); rapid increase in plasma renin (Barrett et al., 1988); depressed antipyrine clearance, an indicator of intrinsic hepatic clearance (Gumbleton and Benet, 1991); reduced *in vivo* rate of protein synthesis in liver and lung (Heys et al., 1989); decreased packed cell volumes in dogs (Usenik and Cronkite, 1965), miniature swine (Sawyer et al., 1971), and mice (Friedman, 1959); altered

gonadotropin secretion patterns in the rat (Chappel and Barraclough, 1976), baboon (Hagino, 1979), and rabbit (Mills et al., 1981); increased level of plasma growth hormone (GH), and accentuated GH response to GH-releasing hormone administration due, at least in part, to reduced somatostatin release from the hypothalamus (Hosoi et al., 1988); elevated serum prolactin in pentobarbital-anesthetized rats following decapitation (Nazian, 1988); age-dependent changes in serum testosterone of rats decapitated after administration of pentobarbital, thiopental, or thiamylal (Nazian, 1988); inhibition of normal masculinization in male hamsters given pentobarbital on postnatal days 2–4 (Clemens et al., 1979); altered morphology of Type I hair cells from the vestibular epithelium of the inner ear of guinea pigs after thiopental administration (Scarfone et al., 1991); decreased intraocular pressure (Ilkiw, 1992); resting myopia in humans and nonhuman primates, due largely to changes in central parasympathetic neuronal tone (Crawford et al., 1990); increased metastasis in rats (Agostino and Clifton, 1964); increased lethality in mice when barbiturates are used concurrently with cyclophosphamide (Rose et al., 1973); altered proximal tubule reabsorption in rats given thiobutabarbitol (Inactin) (Elmer et al., 1972); and hyperglycemia in hamsters, unrelated to duration of anesthesia or degree of surgical manipulation (Turner and Howards, 1977), not seen in rats (Hinton, 1982).

7. Barbiturate Antagonists

Although concurrent use of preanesthetic agents can substantially reduce the dosage of barbiturate needed for anesthesia (Booth, 1988a; Muir et al., 1991), there are no clinically useful specific barbiturate antagonists. Bicuculline and picrotoxin, as GABA_A-antagonists, are used experimentally for confirmation of GABA-mediated effects (Bloom, 2006). Barbiturate sleep time in rats is decreased by the neurostimulatory neurosteroid pregnenolone sulfate, which is consistent with its antagonist action on the GABA_A receptor (Akwa and Baulieu, 1999). Thyrotropin-releasing hormone (TRH) reduces pentobarbital sleep time in dogs (Hernandez et al., 1987), likely due to pharmacodynamic effects associated with sympathoadrenal activation (Schaefer et al., 1989). Effects of thiopental anesthesia are reduced in dogs and cats following administration of nonspecific agents such as 4-aminopyridine, amphetamine, or yohimbine (Hatch, 1973; Hatch et al., 1984).

C. Chloral Hydrate

1. Description

Chloral hydrate (trichloroacetaldehyde monohydrate) is a Schedule IV (Controlled Substances Act) sedative and hypnotic agent that has been in human clinical use since 1869, and in veterinary use since shortly thereafter (Branson, 2001). Its use has declined steadily in recent years, the result of improved drugs

and concerns over drug safety. Current human use of chloral hydrate is limited largely to the short-term treatment of insomnia in adults, to aid in the performance of dental and diagnostic procedures in children (Charney et al., 2006).

Chloral hydrate has been used in veterinary medicine primarily as a premedication prior to general anesthesia in horses and cattle. It has also been used alone and in combination with magnesium sulfate for surgical anesthesia in horses and cattle; the products Chloropent and Equithesin, in which chloral hydrate was combined with magnesium sulfate and pentobarbital, are no longer commercially available (Branson, 2001). Current use of chloral hydrate in veterinary practice is limited, and generally not recommended (Hall et al., 2001).

In the research setting, chloral hydrate has been used to achieve medium-duration, light anesthesia, with minimal effects on cardiovascular function or reflexes. However, at doses required for surgical anesthesia, the safety margin is reduced significantly and recovery is prolonged (Flecknell, 1996). There have been few, if any, controlled studies of the anesthetic or analgesic actions of chloral hydrate (Silverman and Muir, 1993).

2. Biodisposition

Chloral hydrate is readily absorbed from the GI tract, but onset of full effect by this route is slow (Green, 1979). Rate of metabolism varies with species but is generally rapid in mammals, and occurs predominately in the liver (Daniel et al., 1992). Most of the drug is reduced by hepatic alcohol dehydrogenase to trichloroethanol, an active metabolite that accounts for most of its hypnotic action. Trichloroethanol is metabolized primarily by hepatic conjugation with glucuronic acid to form an inactive metabolite that is excreted in the urine; a small portion of the drug is excreted unchanged (Branson and Booth, 1995; Charney et al., 2006). Although hypnotic action of chloral hydrate is attributed to trichloroethanol, both chloral hydrate and trichloroethanol enhance the response to submaximal concentrations of GABA on GABA_A receptor subunits expressed in *Xenopus laevis* oocytes (Garrett and Gan, 1998) and human embryonic kidney 239 cells (Krasowski and Harrison, 2000).

Trichloroacetic acid is a quantitatively lesser metabolite of chloral hydrate without sedative effect. There are species-specific differences in the predominant pathway of its formation, by either oxidation of trichloroethanol or direct oxidation of chloral hydrate. There are significant differences in the rates of metabolism of chloral hydrate, trichloroethanol, and trichloroacetic acid in rat, mouse, and humans (Daniel et al., 1992; Lash et al., 2000; Lipscomb et al., 1996).

The metabolism of chloral hydrate has received increased attention in recent years, because of its place in the metabolism of trichloroethylene, a common metal-degreasing solvent that is a rodent carcinogen (Caldwell and Keshava, 2006; Lash et al., 2000). Hepatocarcinogenicity of trichloroethylene in the mouse is believed due primarily to trichloroacetic acid (Bronley-DeLancey et al., 2006), which also may be responsible for the

cardiac effects of high doses of chloral hydrate (Laurent et al., 2006).

3. *Reported Pharmacologic Effects*

In hypnotic doses, the depressant effect of chloral hydrate is limited to the cerebrum, with minimal effects on medullary centers. Motor and sensory nerves are not affected except at high doses, and analgesia is minimal (Branson and Booth, 1995; Flecknell, 1987). Cerebral depression occurs slowly, and use of chloral hydrate for euthanasia of small animals may be preceded by gasping, muscle spasms, and vocalization (AVMA, 2001). In the rat, the basal activity of nigrostriatal dopamine-containing neurons is reduced compared with unanesthetized paralyzed controls (Kelland et al., 1990). The high-affinity states of dopamine D2 and D3 receptors, serotonin 5HT-2A receptors, beta-2-adrenoceptors, alpha1 and alpha2 adrenoceptors, opiate receptors, and muscarinic receptors are inhibited in vitro by clinical concentrations of chloral hydrate (Seeman and Kapur, 2003). Steward et al. (2005) reviewed the effect of several anesthetics, including chloral hydrate, on neurotransmitter systems in the context of the rat brain blood oxygen level-dependent (BOLD) contrast pharmacological MRI.

Hypnotic doses of chloral hydrate have minimal effects on cardiorespiratory function (Branson and Booth, 1995), but anesthetic doses may be severely depressive (Field et al., 1993; Rodrigues et al., 2006). In the dog, IV administration results in respiratory depression and lowered blood pressure, and sensitization of the heart to sudden vagal arrest or arrhythmias (Soma, 1983; Strobel and Wollman, 1969). Cardiac dysrhythmias are the main complication of acute chloral hydrate overdose in humans (Laurent et al., 2006). In a cellular model of simulated myocardia ischemia, diazoxide-induced cell protection of mitochondrial K_{ATP} channel activity was potentiated by the chloral hydrate metabolite 2,2,2-trichloroethanol (Zaugg et al., 2002).

Chloral hydrate solution is irritating to the stomach mucosa and causes severe inflammation and necrosis with perivascular injection (Booth, 1988a; Ogino et al., 1990). Concentrated solutions may produce hemolysis and hematuria, and hepatic and renal damage may follow large repeated doses (Soma, 1983; Strobel and Wollman, 1969). Adynamic ileus, with morbidity and death, has been attributed to IP administration of high concentrations of chloral hydrate in the rat (Fleischman et al., 1977) and hamster (Dada et al., 1992); lower concentrations will minimize this effect (Vachon et al., 2000). Transient adynamic ileus has also been observed following IP administration in the calf and pig (Silverman and Muir, 1993); this route cannot be recommended for survival procedures. Chloral hydrate in relatively large and repeated doses is carcinogenic in the mouse (Caldwell and Keshava, 2006). Genotoxic effects have been demonstrated in a number of in vivo and in vitro studies (Ikbal et al., 2004).

In adult male HsdBrl:WH Wistar rats, chloral hydrate enhances basal expression of IL-1 β and IL-6 mRNA in rat

spleen; TNF α mRNA is unaffected (Bette et al., 2004). Chloral hydrate decreases in vivo antibody levels in adult male Holtzman Sprague-Dawley rats even 3 weeks after exposure, whereas halothane, methoxyflurane, and ketamine/xylazine do not (Lockwood et al., 1993).

D. Alpha-Chloralose

1. *Description*

Chloralose is the weakly water-soluble reaction product of glucose with anhydrous chloral (trichloroacetaldehyde); the reaction produces alpha and beta isomers. While hypnotic activity resides almost exclusively with alpha-chloralose, the beta isomer is thought to be responsible for convulsions and toxicity (Branson and Booth, 1995). Alpha-chloralose is solubilized for administration by several routes, including oral, by heating to 60°C, or mixing with 25% urethane or other solubilizing agents (Storer et al., 1997).

Alpha-chloralose produces hypnosis of long duration (8–10 hours), with minimal effect on reflexes. Analgesia generally has been considered poor (Flecknell, 1987; Strobel and Wollman, 1969), although it may be adequate for some procedures (Silverman and Muir, 1993). The effectiveness of alpha-chloralose as an anesthetic appears to vary among species; it is probably not effective in the dog (Holzgreffe et al., 1987). Chloralose use alone in veterinary practice, or experimentally for survival procedures, is not recommended due to rough induction, prolonged recovery, and seizure-like activity in some species (Hall et al., 2001; Silverman and Muir, 1993). It has been useful in avian capture (Belant and Seamans, 1999; Hayes et al., 2003).

Alpha-chloralose is still used in physiological studies to preserve respiratory and cardiac reflexes (Branson and Booth, 1995), in long-term neuroscience regimens (Storer et al., 1997), and for functional MRI studies in rats (Steward et al., 2005). Surgical manipulations should not be performed with chloralose alone, and physiological experiments typically involve induction with a short-acting anesthetic.

2. *Biodisposition*

Chloralose is metabolized to glucose and chloral which, in turn, is metabolized to trichloroethanol. Its metabolism and action, therefore, should resemble those of chloral hydrate (Branson and Booth, 1995). However, the duration of effect following a single dose is much longer with chloralose than with chloral hydrate, and it has been reported in human toxic exposures that alpha-chloralose, but not trichloroethanol, could be detected in blood and urine (Kintz et al., 1996). Furthermore, alpha-chloralose directly enhances the response to submaximal concentrations of GABA on GABA_A receptor subunits expressed in *X. laevis* oocytes (Garrett and Gan, 1998) and human embryonic kidney 239 cells (Krasowski and Harrison, 2000).

3. Reported Pharmacologic Effects

Alpha-chloralose is used especially for chemical restraint with minimal cardiac and respiratory depression (Flecknell, 1987), although assisted respiration may be required at the higher doses necessary when the agent is used alone (Holzgrefe et al., 1987). Spinal reflexes may actually be increased, and strychnine-like convulsions have been reported in the dog and cat. Spontaneous movements are common, and animals may respond to tactile and auditory stimuli (Branson and Booth, 1995; Soma, 1983). Alpha-chloralose, like barbiturates, induces a GABA-mimetic action on chloride currents in frog isolated sensory neurons (Ishizuka et al., 1989).

Transient changes following chloralose administration in the dog include decreased mean arterial blood pressure and peripheral resistance, and increased heart rate (Boucher et al., 1991; Cox, 1972). However, there appear to be relatively few maintained changes in cardiopulmonary variables when this agent is used alone. Arterial pressure and heart rate of chloralose-anesthetized rats are similar (Wang et al., 1991) or elevated (Folle and Levesque, 1976) compared with values in conscious controls. In a cellular model of simulated myocardia ischemia, diazoxide-induced cell protection of mitochondrial K_{ATP} channel activity was potentiated by the alpha-chloralose metabolite 2,2,2-trichloroethanol (Zaug et al., 2002).

Alpha-chloralose is commonly considered to preserve normal autonomic reflex activity, including baroreceptor and chemoreceptor reflexes (see review by Holzgrefe et al., 1987). However, chloralose alters the baroreceptor reflex in lambs (Covert et al., 1988), rats (Fluckiger et al., 1985; Shimokawa et al., 1998; Wang et al., 1991), and rabbits (Ishikawa et al., 1984); the somato-sympathetic-adrenal reflex (Gaumann and Yaksh, 1990) and micturition reflex (Rudy et al., 1991) in cats; and the response to carotid chemoreceptor stimulation in the dog (Zimpfer et al., 1981). Myocardial contractility is impaired (Parker and Adams, 1978). Steward et al. (2005) has reviewed the effect of several anesthetics, including alpha-chloralose, on neurotransmitter systems in the context of the rat brain blood oxygen level-dependent (BOLD) contrast pharmacological MRI.

In the rat, subanesthetic doses of chloralose do not increase serum renin activity, in contrast to several other anesthetic agents (Pettinger et al., 1975). IP administration of chloralose to guinea pigs, rats, pigs, and calves leads to severe inflammatory responses, which may be related to the concentration used (Silverman and Muir, 1993).

E. Metomidate and Etomidate

1. Description

Etomidate is a hypnotic agent developed and used primarily in humans. There is no analgesic effect, and cardiorespiratory effects are minimal. Metomidate is a hypnotic agent

used in a variety of animal species. It has strong central muscle-relaxant effects, but little to no analgesic properties in larger animals; muscular tremors and involuntary movements may occur. Both metomidate and etomidate generally require addition of an opioid for surgical anesthesia (Flecknell, 1987). (*R*)-metomidate hydrochloride is commercially available (ABX GmbH, Germany) and is marketed as Aquacalm for use in aquarium and non-food fish (Syndel Laboratories, Canada). Metomidate was previously available as Hypnodil for use in swine; however, it was banned in the European Union in 1997 (Ungemach et al., 1997). These imidazole agents are potentially useful for long-term, continuous infusion anesthesia due to minimal cumulative effect and good preservation of cardiovascular function.

Despite the lack of analgesic properties in larger mammals, Green et al. (1981) found that short-term, light surgical anesthesia lasting 12–15 minutes could be produced in the mouse with either metomidate (50 mg/kg) or etomidate (30 mg/kg) given IP; side effects included jerking and twitching movements, but cardiorespiratory depression was minimal. Anesthetic duration and depth were improved by a metomidate–fentanyl combination (60 mg/kg:0.06 mg/kg) given subcutaneously (Green et al., 1981). Adverse reactions, including marked bradycardia, were observed in chickens using metomidate (Christiansen et al., 1987). Red-necked ostriches (*Struthio camelus*) darted with metomidate (18 mg/kg) showed no signs of sedation (Ostrowski and Ancrenaz, 1995).

Although not approved for use in food fish, metomidate immersion produces dose-dependent sedation and anesthesia in hybrid striped bass (*Morone chrysops* × *M. saxatilis*), channel catfish (*Ictalurus punctatus*), and Chinook salmon (*Oncorhynchus tshawytscha*). In channel catfish, 16 ppm metomidate caused 65% mortality while 6 ppm was judged the minimum concentration required for sedation and anesthesia (Small, 2003). In Chinook salmon, 6–10 ppm was judged effective, with no change in cardiovascular parameters (Hill and Forster, 2004). Cortisol levels were not increased in both hybrid striped bass and channel catfish, implying that metomidate may be useful in reducing fish stress (Davis and Griffen, 2003; Small, 2003). This conclusion, however, may not hold true in light of the inhibiting effect of imidazole drugs on steroidogenesis (see below).

2. Biodisposition

Etomidate is lipophilic (octanol/water partition coefficient: 1,000) and a weak base ($pK_a = 4.5$; $pH = 8.2$, 99% unionized at physiological pH). It is rapidly distributed following IV administration with peak brain levels reached in less than 1 minute, and has a biologic half-life of about 40 minutes in rats. Etomidate is rapidly metabolized by ester hydrolysis in the liver (primarily) and plasma to inactive products that are excreted in the urine (Heykants et al., 1975; Lewi et al., 1976). The therapeutic index in rats and mice is wide for loss of the righting reflex (LD50:ED50 = 29:1) (Green et al., 1981).

Etomidate pharmacokinetics were determined in cats after IV administration (3.0 mg/kg); disposition best conformed to a 2- and a 3-compartment open pharmacokinetic model. The first and most rapid distribution half-life was 0.05 hours, with a second distribution half-life of 0.35 hours. Other data included elimination half-life (2.89 hours), apparent volume of distribution (11.87 L/kg), apparent volume of distribution at steady state (4.88 L/kg), apparent volume of the central compartment (1.17 L/kg), and total clearance (2.47 L/kg/h) (Wertz et al., 1990). Hemorrhagic shock in swine produces minimal changes in etomidate pharmacokinetics and no change in pharmacodynamics (Johnson et al., 2003). Increased hypnotic effect attributed to pharmacokinetic changes is observed in hemorrhaged rats (De Paepe et al., 1999).

The pharmacokinetics of IV (3 mg/kg), external bath treatment (9 mg/L), and oral administration of metomidate (7 mg/kg) were described for halibut (*Hippoglossus hippoglossus*) and turbot (*Scophthalmus maximus*) (Hansen et al., 2003). Metomidate had shorter elimination half-life and higher plasma concentrations in turbot compared with halibut, with both species displaying rapid uptake, distribution and excretion phases. Following IV administration, the volumes of distribution at steady-state were 0.21 L/kg (halibut) and 0.44 L/kg (turbot). Plasma clearance was 0.099 L/h/kg in halibut and 0.26 L/h/kg in turbot, and the elimination half-life was calculated to be 5.8 and 2.2 hours in halibut and turbot, respectively. Mean residence time was 2.2 hours in halibut and 1.7 hours in turbot. Following oral administration, elimination half-life was 3.5 hours in turbot. The maximum plasma concentration was 7.8 mg/L in turbot 1 hour after administration. The oral bioavailability was calculated to be 100% in turbot. The maximum plasma concentration following 5 minutes external bath treatment was 9.5 and 13.3 mg/L in halibut and turbot, respectively.

3. Reported Pharmacologic Effects

The neurophysiologic actions of etomidate are similar in many respects to the barbiturates and other injectable anesthetic agents such as alphaxalone (Way and Trevor, 1986). Etomidate decreases cerebral metabolic rate and ICP, and has anticonvulsant properties (Batjer, 1993; Milde et al., 1985; Robertson, 1992; Wauquier, 1983). In rats, the pattern of metabolic depression produced by etomidate differs markedly from that produced by barbiturates, which affect all brain regions to a similar degree (Davis et al., 1986). Etomidate reduces glucose consumption the most in the forebrain (telencephalon and diencephalon) (−25 to −35%) while the hindbrain is minimally affected. There is no demonstrable dose dependency; 1 mg/kg suppressed regional cerebral glucose utilization as much as 12 mg/kg.

In contrast to other IV anesthetics, the depressive effects of etomidate on myocardial contractility are minimal at concentrations necessary to produce anesthesia. In dogs, anesthetic doses

of etomidate have little or no effect on heart rate, blood pressure, myocardial performance, or respiratory function (Muir and Mason, 1989; Pascoe et al., 1992). In artificially ventilated rats, there is minimal effect on heart rate and blood pressure, but aortic flow is markedly decreased (De Wildt et al., 1983). Rat atrial and portal vein contractions are inhibited by etomidate addition in vitro (Bunting et al., 1989); however, direct negative inotropic effects of etomidate are dose-dependent and may not reflect concentrations encountered clinically (Stowe et al., 1992). In a model of stunned myocardial ischemic preconditioning, etomidate has no effect on cardiac myocyte K_{ATP} channel activity (Zaugg et al., 2002).

Imidazole compounds, including etomidate and metomidate, inhibit adrenal steroidogenesis through inhibition of 11 beta-hydroxylase (CYP11B1, P450 11beta) (Mitterhauser et al., 2003; Preziosi and Vacca, 1988). Compared with thiopental, a single bolus injection of etomidate (2 mg/kg IV) suppresses adrenocortical function in dogs for 2–6 hours (Dodam et al., 1990). Compared with diazepam–ketamine, etomidate (2 mg/kg IV) suppresses adrenocortical function in cats for at least 5 hours (Moon, 1997). In a metomidate (2.5 mg/kg/h) and ketamine (3.0 mg/kg/h)-anesthetized swine model infused with live *Pseudomonas aeruginosa*, circulatory failure occurred at 4.3 hours of bacteremia; when supplemental cortisol was administered, hemodynamics were stabilized, but death occurred after 11 hours due to bacteremia-induced pulmonary edema (Neumann et al., 1989).

Side effects of etomidate use include pain on injection, nausea, vomiting, and myoclonic movements during induction (Booth, 1988a). These effects are reduced following IV administration of diazepam, acepromazine, or morphine immediately prior to etomidate (Muir and Mason, 1989).

Due to its formulation in propylene glycol, hemolysis may occur following IV administration of etomidate (Doenicke et al., 1997; Moon, 1994). An etomidate formulation in aqueous sulfobutyl ether β -cyclodextrin has been developed. Pharmacokinetic and pharmacodynamic parameters were not statistically different for the two formulations in dogs (McIntosh et al., 2004). In vivo hemolysis after IV administration of etomidate in propylene glycol was 10-fold higher than that in the case of sulfobutyl ether β -cyclodextrin enabled formulation. Although etomidate in propylene glycol cannot be given subcutaneously because of the cosolvent in the formulation, a 12 mg/ml aqueous solution of etomidate in 20% (w/v) sulfobutyl ether β -cyclodextrin was well tolerated by this route (McIntosh et al., 2004).

F. Propofol

1. Description

Propofol is a substituted isopropylphenol (2,6-diisopropylphenol), chemically distinct from the barbiturates, steroids, and imidazoles. Propofol is an oil at room temperature and insoluble

in aqueous solution. Unlike the thiobarbiturates, etomidate, and ketamine, propofol is not a chiral drug.

The currently available 1% commercial preparation is an aqueous emulsion of 10% soybean oil, 2.25% glycerol, and 1.2% purified egg phosphatide (Sebel and Lowdon, 1989; Stoelting and Hillier, 2006). Commercially available soybean emulsion preparations differ with respect to pH and the presence of preservative, either disodium edentate (EDTA) or metabisulfite (Marik, 2004; Stoelting and Hillier, 2006); these formulations, however, are not considered antimicrobially preserved products under USP standards (Sklar, 1997). The soybean emulsion supports bacterial growth such that strict asepsis must be used during handling, administration, and storage; the manufacturer of PropoFlo (Abbott Animal Health, North Chicago, IL) recommends discarding unused product within 6 hours of opening.

Propofol is degraded in the presence of oxygen and supplied in single-dose vials under nitrogen. Initial clinical formulations of the oil used the solubilizing agent Cremophor EL (polyoxyethylated castor oil); however, Cremophor is known to result in histamine release in the dog, and has been associated with pain on injection and anaphylactoid reactions in the rat and pig (Glen and Hunter, 1984). The currently available 1% soybean emulsion is also associated with pain on IV injection, but this can be reduced by selecting a larger vein or prior administration of 1% lidocaine through the same vein. Mixing propofol with other drugs is not recommended, as coalescence of oil droplets may pose a risk for pulmonary embolism. Hypertriglyceridemia and pancreatitis are uncommon complications with the soybean emulsion preparation. Newer alternatives being investigated include 1% and 5% nanodroplet microemulsions (Boscan et al., 2006; Morey et al., 2006a, 2006b), the water-soluble propofol prodrug propofol phosphate (Banaszczyk et al., 2002), and an 80% propofol-propylene glycol transdermal preparation (Takahashi et al., 2005).

2. Biodisposition

The anesthetic properties of propofol are similar in most respects to those of the thiobarbiturates. Recovery from a single dose of propofol is more rapid, however, and there is greater potential as a continuous infusion agent due to minimal cumulative effect (Glen, 1980; Sebel and Lowdon, 1989). Pulmonary uptake of propofol is significant and can influence initial availability. Redistribution of propofol is extensive. Propofol clearance from plasma exceeds hepatic blood flow, such that tissue uptake, as well as hepatic oxidative metabolism by cytochrome P450 2B6 and 2C9, is an important factor (Court et al., 2001). Hepatic metabolism results in inactive, water-soluble sulfate and glucuronic acid metabolites that are excreted by the kidneys. Propofol also undergoes ring hydroxylation by cytochrome P450 to form 4-hydroxypropofol, which has approximately one-third of the hypnotic activity of propofol; 4-hydroxypropofol is subsequently glucuronidated or sulfated

to inactive metabolites. Metabolism is sufficiently rapid that the speed of IV injection can affect both time to induction and the dose needed (Glen, 1980).

Pharmacokinetic profiles following IV administration of the Cremophor preparation are similar in the rat, pig, rabbit, and cat. Plasma concentrations follow a biexponential curve, with a very short distribution half-life (1–6 minutes) and an elimination half-life between 16 and 55 minutes; in each case, lowest values are observed in the rat and rabbit. Total apparent volume of distribution is large, consistent with that for a lipophilic drug. The plasma concentration associated with awakening ranges from 1 to 4 mg/ml in the pig, rat, and cat, but is 7 mg/ml in the rabbit; in the latter, awakening occurs during the distribution phase of the drug (Adam et al., 1980). Cockshott et al. (1992) came to similar conclusions using bolus injection of the soybean emulsion formulation, although they also found that the data were better fitted by a triexponential function when the sampling period was adequate. Total body clearance was rapid in the dog, rat, and pig (50–80 ml/min/kg) and even higher in the rabbit (340 ml/min/kg). In hemorrhaged hypovolemic rats, the propofol dose needed to reach the target electroencephalographic end-point was reduced by 60%; this was attributed to a decrease in propofol clearance and distribution volume (De Paepe et al., 2000).

The context-sensitive half-time describes the time required for drug concentration to decrease by 50% after terminating infusion, and reflects both distribution and metabolism. In humans, the context-sensitive half-time is less than 40 minutes for propofol infusions lasting up to 8 hours (Hughes et al., 1992). The duration of propofol infusion minimally influences the context-sensitive half-time because rapid metabolic clearance of drug returning from tissue storage sites to the circulation does not slow the decrease in drug plasma concentration.

The clearance of propofol is slower in greyhounds compared with other dog breeds. At a substrate concentration of 20 μ M, propofol hydroxylase activity was significantly lower in greyhound microsomes (1.7 nmol/mg/min) compared with beagle dog microsomes (5.1 nmol/mg/min), but was not statistically different compared with mixed-breed dog microsomes (3.1 nmol/mg/min). These results indicate breed-specific differences in propofol hydroxylase activity and that a lower level of hydroxylation of propofol by one or more hepatic cytochrome P450 isoforms may contribute to slow pharmacokinetic clearance of propofol by greyhounds (Court et al., 1999).

Brain sensitivity to propofol is influenced by age and administration rate. In male Sprague-Dawley rats (MOL:SPDR:Han) ranging in age from 23 to 776 days, younger animals require higher induction doses of propofol and have higher serum concentrations than older animals. Older animals, however, have higher brain concentrations of propofol at the EEG end-point than younger animals (Larsson and Wahlstrom, 1998). These differences can be explained by pharmacokinetic rather than pharmacodynamic differences.

Clear aqueous microemulsions of propofol are being developed as alternatives with potentially fewer adverse side effects than the turbid soybean macroemulsion preparation. A study in adult Sprague-Dawley rats of either sex demonstrated that significantly greater IV doses of propofol microemulsion were required to induce anesthesia, irrespective of surfactant concentration or type, than with the soybean macroemulsions (Morey et al., 2006a). In dogs administered either a 24.5 nm microemulsion or a commercial 1% soybean macroemulsion of propofol, no differences were noted with respect to the administered dose (10.3 and 9.7 mg/kg, respectively), time to induction (1.0 and 1.0 minutes), time to recovery (17.4 and 18.2 minutes), heart rate, arterial blood pressure, respiratory rate, hemogram variables, prothrombin time, activated partial thromboplastin time, fibrinogen concentration, platelet concentration, or plasma propofol concentrations (Morey et al., 2006b). In horses, the quality of induction was judged slightly better with either a 1 or 5% high micellar 12 nm microemulsion propofol than with the standard 1% soybean macroemulsion; recovery characteristics were qualitatively and quantitatively indistinguishable among treatment groups (time to stand after anesthesia was 34.3, 34.1, and 39.0 minutes in horses treated with the commercial formulation, 1% microemulsion, and 5% microemulsion, respectively) (Boscan et al., 2006). No clinically relevant changes in hematologic and serum biochemical analytes were detected during a 3-day period following anesthesia.

Propofol phosphate, a water-soluble propofol prodrug, has also been developed as an alternative to the 1% soybean macroemulsion (Banaszczyk et al., 2002). It is enzymatically converted by alkaline phosphatase to active propofol and an inorganic phosphate following IV injection. In 2-month-old female CD-1 mice, the hypnotic dose (HD_{50}), lethal dose (LD_{50}), and safety index (defined as a ratio: LD_{50}/HD_{50}) of propofol phosphate were 165.4 mg/kg, 600.6 mg/kg, and 3.6 mg/kg, respectively. Active propofol was produced with half-lives of 5.3 minutes in 8-week-old Sprague-Dawley rats, 2.1 minutes in female New Zealand White rabbits, and 4.4 minutes in 8–12 week old male and female White Barrow and Duroc pigs. Doses greater than 125 mg/kg were necessary to produce ataxia and sedation in mice. Doses greater than 50 mg/kg induced sedation in rats, with death occurring at 200 mg/kg. Rabbits injected with 150 mg/kg only became lethargic prior to death at 158 minutes after injection. In pigs, 14 mg/kg produced ataxia, and 72 and 84 mg/kg produced sedation; prolonged apnea (125 minutes) and recovery (5 hours) occurred at 144 mg/kg. The elimination half-life was 24 minutes in rats, 21 minutes in rabbits, and 225 minutes in pigs.

3. *Reported Pharmacologic Effects*

As with other GABA_A agonists, propofol is generally considered to be poorly analgesic, but spinal cord analgesic effects can be demonstrated (Frolich et al., 2005; Jewett et al., 1992). Anesthetic properties and hemodynamic effects of propofol are

similar for the Cremophor and soybean emulsion formulations, although the soybean formulation has slightly greater potency in mice and male rats (Glen and Hunter, 1984).

Propofol is less effective in the rabbit than other species (Flecknell, 1996). Administration at relatively high doses (≥ 10 mg/kg IV) results in sedation of very short duration with little reflex depression or antinociception, while higher doses or longer infusions produce respiratory arrest and death (Aeschbacher and Webb, 1993a, 1993b; Banaszczuk et al., 2002; Blake et al., 1988; Glen, 1980; Ko et al., 1992; Ypsilantis et al., 2006). In mice, induction time and time to recover coordination are shorter with propofol than with thiopental; "utilization rate" of propofol, the amount required to maintain prolonged anesthesia, is greatest in mice compared with several other species (Glen, 1980). Apnea commonly occurs in mice, rabbits, cats, and pigs, especially at higher doses; in rhesus monkeys it is seldom seen. In rabbits, there is a dose-dependent decrease in minute volume (Bellman and Pleuvry, 1981); respiratory arrest may follow the administration of doses high enough to prevent pain response (Glen, 1980). Apnea occurred in cats at 10 mg/kg propofol, but not in dogs at 6 mg/kg, administered IV on three consecutive days (Matthews et al., 2004).

Propofol decreases cerebral oxygen consumption, reduces ICP, and has anticonvulsive activity (Marik, 2004); it is also a potent antioxidant, has anti-inflammatory properties, and is a bronchodilator. Propofol is associated with excitatory motor activity, such as myoclonic jerking and opisthotonus; however, barbiturate-like EEG changes are observed in rats (Glen, 1980). Propofol has anticonvulsive properties in mice and rats (Lee et al., 1998; Lowson et al., 1990), as well as in other species, presumably due to GABA-mediated presynaptic and postsynaptic inhibition of chloride channels. Steward et al. (2005) have reviewed the effect of several anesthetics, including propofol, on brain neurotransmitter systems in the context of the rat brain blood oxygen level-dependent (BOLD) contrast pharmacological MRI.

Hypotension associated with propofol administration has raised concerns regarding its use in patients with cardiovascular disease, particularly volume depletion or endotoxemia; changes other than hypotension are more variably reported (Ilkiw et al., 1992). Heart rate is elevated following propofol in rats (Rocchiccioli et al., 1989) and rabbits (Blake et al., 1988). Blood pressure is maintained during light propofol anesthesia in the rabbit (Blake et al., 1988), but decreased at higher doses; cardiac output may be elevated, reduced, or remain unchanged (Aeschbacher and Webb, 1993b; Blake et al., 1988; Glen, 1980; Van Leeuwen et al., 1990). Antinociceptive doses of propofol in the rat result in lowered arterial pressure and heart rate (Tan et al., 1993). Carmichael et al. (1993) confirmed a dose-dependent decrease in blood pressure in rats. There was no effect on cardiac output, or coronary or renal blood flows, and splanchnic hemodynamics and liver oxygenation were not adversely affected. Propofol dose-dependently antagonizes beta-adrenoceptors in rat myocardial membranes

(Zhou et al., 1999). Oxygen utilization is impaired and electron flow is inhibited in the guinea pig cardiomyocyte, and ventricular performance is significantly depressed in the isolated perfused heart (Schenkman and Yan, 2000). In swine, propofol causes a dose-dependent decrease in myocardial contractility (Coetzee et al., 1989; Glen, 1980; Glen and Hunter, 1984). A negative inotropic response has been demonstrated in vitro along with marked attenuation of coronary flow autoregulation (Stowe et al., 1992). Rat atrial and portal vein contractions are inhibited in vitro by propofol addition (Bunting et al., 1989).

The baroreceptor-heart rate reflex is suppressed following propofol administration in rats (Rocchiccioli et al., 1989) and rabbits. The suppression is much less than with alphaxalone/alphadolone (Blake et al., 1988), thiopentone, or ketamine (Blake et al., 1982; Van Leeuwen et al., 1990). In the rabbit and cat, carotid artery infusion of propofol suppresses afferent impulses from single chemoreceptor fibers in response to hypoxia and hypercapnia (Ponte and Sadler, 1989). Pharmacologic activation of adenosine triphosphate-regulated K_{ATP} channels mimics ischemic preconditioning and decreases infarct size or improves functional recovery of ischemic-reperfused stunned myocardium; propofol does not affect cardiac myocyte K_{ATP} channel activity (Zaugg et al., 2002), and may inhibit the ischemic preconditioning-like cardioprotective effect of inhalational anesthetics (Kohro et al., 2001).

In a sheep model, propofol crosses the placenta and reaches the fetus within 2 minutes of administration (Andaluz et al., 2003). Maternal levels are three times higher than fetal levels following a single bolus IV dose and six to nine times higher following 1 hour continuous infusion, demonstrating a placental barrier effect. Mean residence times are similar for the mother and fetus following a single IV bolus but increased in the fetus with continuous infusion. Fetal elimination is prolonged following a single bolus or continuous infusion, with half-life times more than twice that observed for the mother. Plasma protein binding is higher in the mother than the fetus (Gin et al., 1991), which tends to limit placental transfer as only unbound drug can pass. However, as propofol may bind less to fetal plasma proteins than to maternal plasma proteins, Andaluz et al. (2003) speculate that the free fraction of fetal drug may be higher and is likely to be pharmacologically active. Hence, the use of continuous infusion or multiple bolus injections of propofol are not recommended for cesarean section anesthesia.

In cats, repetitive daily anesthesia with propofol is associated with Heinz body formation; this may be due to propofol being a phenol compound. Heinz bodies developed following three consecutive days of induction with 6 mg/kg IV propofol combined with 30 minutes of maintenance anesthesia at a constant rate infusion of 0.2–0.3 mg/kg/min; generalized malaise, anorexia, and diarrhea were reported after five consecutive days of propofol anesthesia (Andress et al., 1995). On the other hand, clinically insignificant increases in the number of Heinz bodies were reported in cats anesthetized for three consecutive days with 10 mg/kg propofol (Matthews et al., 2004).

Propofol infusion syndrome is a real, albeit rare, entity. It is characterized by metabolic acidosis, acute cardiomyopathy and skeletal myopathy, is often lethal, and is strongly associated with propofol infusions rates of 5 mg/kg/h and greater for more than 48 hours. There is evidence that the syndrome is caused by the failure of free fatty acid metabolism due to inhibition of entry into the mitochondria and also specific sites in the mitochondrial respiratory chain. The syndrome therefore mimics the mitochondrial myopathies (Short and Young, 2003).

4. Immune System Effects

Propofol may produce an additional risk factor for perioperative infection (Sklar, 1997); this appears to be due to reticuloendothelial system dysfunction caused by the soybean lipid emulsion rather than an effect of propofol itself. In a retrospective study of 863 dogs and cats with clean surgical wounds, 6 out of 46 animals receiving propofol (13%) developed postoperative infections, compared with 33 of 817 (4%) animals not receiving propofol (Heldmann et al., 1999). Confounding factors for this study include the sharing of propofol syringes between more than one patient following change of hypodermic needle, no handwashing or external vial disinfection, and retention of opened drug for >6 hours as recommended by the manufacturer. In addition, intraoperative hypothermia, suture type, incision size and location, and duration of surgery and anesthesia were not controlled or considered in the analysis. *Staphylococcus aureus* grows poorly in propofol at clinically relevant temperatures (Langevin et al., 1999). In a rabbit bacteremia model, both propofol and the soybean lipid emulsion alone increased accumulation of *Escherichia coli* in lung and spleen compared to saline, thus reflecting lipid-induced reticuloendothelial system dysfunction (Kelbel et al., 1999). Propofol impairs several monocyte and neutrophil functions of the non-specific immune system, including polarization, chemotaxis, oxidative burst, and phagocytosis; however, these changes are thought to be due to the soybean emulsion rather than propofol itself (Schneemilch et al., 2004).

On the other hand, propofol has been reported to attenuate proinflammatory cytokine responses, alter expression of nitric oxide, and decrease neutrophil activation in a rat model of endotoxemia (Marik, 2005; Taniguchi et al., 2000, 2002). The molecular mechanism for these effects is not clear. Unlike thiopental, propofol does not inhibit the activation of nuclear factor kappaB (Loop et al., 2002). Propofol is also a potent antioxidant. The added preservatives may have biologic activity: EDTA has anti-inflammatory properties, and metabisulfite may cause lipid peroxidation (Marik, 2005). In a swine model of aortic reconstructive surgery, propofol anesthesia was associated with less neutrophil infiltration, lower plasma proinflammatory cytokine levels, lower production of oxygen free radicals, less lipid peroxidation, and reduced inducible nitric oxide synthase activity compared with sevoflurane (Rodriguez-Lopez et al., 2006).

5. Propofol Antagonists

Although concurrent use of preanesthetic agents can substantially reduce the dosage of propofol needed for anesthesia (Pablo et al., 1997; Watney and Pablo, 1992), there are no specific propofol antagonists that are clinically useful. Picrotoxin, a noncompetitive GABA_A antagonist, and gabazine, a competitive GABA_A antagonist, both increase propofol ED₅₀ in male Sprague-Dawley [CrI:CD(SD)Br] rats by 379 and 362%, respectively (Sonner et al., 2003). TRH reduces propofol sleep time in rats (Larsson et al., 1996), likely due to a pharmacodynamic effects associated with sympathoadrenal activation (Schaefer et al., 1989).

G. Tribromoethanol

1. Description

Tribromoethanol (TBE) solutions are often referred to as Avertin, which is a misnomer. Avertin was the trade name for Winthrop Laboratories proprietary TBE formulation, which is no longer available. Pharmaceutical-grade TBE was marketed under several proprietary names, including Avertin, Bromethol, Ethobrom, Narcolan, and Narkolan, each as a 66.7% w/w solution of TBE in *t*-amyl alcohol where each milliliter contained 1 g TBE (The Merck Index, 1976; Reynolds, 1982). Although this TBE formulation is not commercially available or routinely used for human or veterinary anesthesia for several decades, it has received widespread acceptance for use in the various manipulations required for the production of genetically engineered mice and rats (BVAAF/FRAME/RSPCA/UFAW Joint Working Group on Refinement, 2003; Hogan et al., 1986, 1996; Papaioannou and Fox 1993). Since TBE produces inflammation and peritonitis, it is recommended only for acute terminal studies when administered IP to laboratory animals (Meyer and Fish, 2005).

2. Biodisposition

TBE acts at the GABA_A and glycine receptors (Krasowski and Harrison, 2000). The high-affinity states of dopamine D2 and D3 receptors, serotonin 5HT-2A receptors, beta2-adrenoceptors, alpha2-1 and alpha2-2 adrenoceptors, opiate receptors, and muscarinic receptors are inhibited *in vitro* by clinical concentrations of ethanol anesthetics (Seeman and Kapur, 2003). TBE is metabolized in the liver by conjugation with glucuronic acid and is excreted in the urine as TBE glucuronate (Green, 1979). The pharmacokinetics of TBE have not been described yet.

The concerns regarding the efficacy and safety of TBE, combined with the availability of effective pharmaceutical-grade alternatives, have made the continued routine use of TBE for rodent anesthesia controversial (Silverman, 2003). Acute concentration-dependent abdominal muscle necrosis,

peritoneal inflammation, fibrinous splenic serositis, visceral adhesions, and death have been described in CD-1, OF-1, NMRI, ICR, and NCR (nu/nu) mice, as well as in Mongolian gerbils and Sprague-Dawley rats, following a single IP dose of TBE (Buetow et al., 1999; Goelz, 1994; Lieggi et al., 2005a, 2005b; Norris and Turner, 1983; Reid et al., 1999; Zeller et al., 1998). Even with freshly prepared solutions, high mortality has been reported following a second TBE injection (Green, 1979; Norris and Turner, 1983; Papaioannou and Fox, 1993). High death losses in mice after recovery were associated with fluid distension of the stomach and small intestine, suggesting intestinal ileus as the cause of death (Tarin and Sturdee, 1972). Similar results have been reported in Mongolian gerbils; these effects could be reduced, but not eliminated, by dilution to 1.25% and by reducing the dosage to 300 mg/kg or less (Norris and Turner, 1983).

Recently, Lieggi et al. (2005b) showed that TBE toxicity is not caused by breakdown to DBA in solution, that the pH decrease observed in stored TBE solutions does not necessarily indicate a reaction leading to toxic products, and that pH > 5 does not indicate a safe TBE solution for administration. In an accompanying *in vivo* study, mortality occurred in 10 of 17 female ICR mice receiving 400 mg/kg freshly made TBE (Lieggi et al., 2005a). The pH of this lethal TBE solution was 6.5, as recommended, the solution was found to be free of bacterial contamination and endotoxins, and DBA levels were not increased. Compared with nonlethal stock or working TBE solutions, no new or additional compounds were found by means of gas chromatography-mass spectroscopy. However, ¹H nuclear magnetic resonance spectra of the lethal working solution detected a broad, low-intensity signal at 6.5 ppm, not seen in other tested solutions. Although the identification of this signal was not possible, it is speculated that toxicity was likely associated with the storage of the TBE powder in the bottle and not with the storage of a TBE stock or working solution.

3. Reported Pharmacological Effects

TBE produces a generalized CNS depression, including both the respiratory and cardiovascular centers. In cats, the anesthetic dose by rectal administration is 300 mg/kg, but the margin of safety between anesthetic and lethal dose is narrow. Depression of respiration and circulation, together with its general unpredictability, eventually discouraged clinical use. In dogs, sedation occurs within 10–15 minutes after rectal administration and lasts for more than 1 hour, whereas in cats the depressant effects can last as long as 24 hours (Soma, 1971). In addition to rectal use in cats and dogs, TBE has been administered orally to mammals, reptiles, and birds (Mosby and Canter, 1956).

The duration of TBE anesthesia in mice varies considerably with strain and sex. Recommended TBE doses (IP) in mice range from 125 to 500 mg/kg with 1.25–2.5% solution, with most authors recommending approximately 250 mg/kg (Buetow et al., 1999; Hogan et al., 1986; Papaioannou and Fox, 1993;

Wixson and Smiler, 1997). At 250 mg/kg, surgical anesthesia lasting 16–20 minutes is produced, with good skeletal muscle relaxation, moderate respiratory depression, and full recovery reported within 40–90 minutes. In contrast, others have indicated a highly variable response to TBE, even at relatively high dosages. Koizumi et al. (2002) evaluated TBE sleep-time variation in outbred Jcl:ICR and MCH(ICR) mice; TBE was diluted to 2.5% and administered at 400 mg/kg IP. Sleep time ranged from 0 to 120 minutes, with a mean of 21.5 ± 2.2 minutes (SEM). Susceptibility of Jcl:ICR mice to TBE anesthesia was equivalent between experimental groups, but differed widely between male and female mice, with females showing more susceptibility (greater sleep time) than males. Sex differences were not observed in the inbred strains IAI, IQI, or MCH(ICR). Gardner et al. (1995) administered 400 mg/kg of 2.5% TBE IP to male Hsd:ICR mice. They reported a 3 minute onset of loss of righting reflex (range: 1–14.4 minutes), and a mean time of adequate anesthesia (based on loss of withdrawal reflex to toe pinch) of 6.9 minutes (range: 3.9–15.2 minutes), with 5 of 12 mice not reaching a surgical plane of anesthesia (retention of withdrawal response to interdigital toe pinch). They concluded that TBE produced a high degree of variability in induction times with a relatively short period of adequate anesthesia. Avila et al. (2001) administered TBE (300 mg/kg IP) to black Swiss outbred mice of mixed sex and noted that, in contrast to ketamine (250 mg/kg IP), the duration of anesthesia with TBE was sometimes too brief to conduct experiments measuring intraocular pressure lasting 30 minutes or less. Goelz (1994) concluded that TBE can produce an anesthetic state in CD-1 mice, but that it was inconsistent and often variable.

Generally speaking, cardiac performance is better in mice during TBE anesthesia than with ketamine combinations, but cardiac performance with TBE is not as repeatable over time as with the inhaled anesthetic isoflurane (Hart et al., 2001; Roth et al., 2002). Hart et al. (2001), using a combination of transthoracic echocardiography and closed chest cardiac catheterization, examined cardiac performance in male Swiss Webster mice administered xylazine/ketamine anesthesia (4.1 mg/kg xylazine, 65 mg/kg ketamine) or TBE (375 mg/kg). TBE produced less bradycardia, and less effect on cardiac loading and ventricular function than xylazine/ketamine. In male C57BL/6N mice, Roth et al. (2002) reported that 300 mg/kg TBE produced heart rates and echocardiographic fractional shortening values 15–20 minutes following IP administration similar to the inhaled anesthetic isoflurane. Midazolam/ketamine produced trends similar to, but absolute values lower than those of TBE, while xylazine/ketamine produced significant cardiac depression as evidenced by low heart rate and percent fractional shortening. Roth et al. concluded that isoflurane was the most consistent anesthetic in repeat studies at 12 days and that the anesthetic agent, the timing of echocardiographic measurements, and the genetic background were all critical variables during murine echocardiography.

A single dose of TBE before pregnancy results in impaired fertility (Kaufman, 1977), and administration following ovulation results in postimplantation parthenogenic development in (C57BL \times A₂G) F₁ hybrid mice (Kaufman, 1975). In female Crl:CD-1(ICR)BR, Icolbm:OF-1, and Hanlbm:NMRI mice, xylazine (16 mg/kg) and ketamine (120 mg/kg), administered IP at a volume of 10 ml/kg, produces embryo transfer success rate similar to that observed with TBE (82% surviving offspring with X/K compared with 85% with TBE) (Zeller et al., 1998). In comparison, Papaioannou and Fox (1993) reported an embryo transfer success rate of 60% with TBE.

Thompson et al. (2002) investigated the effects of anesthetic agents, including TBE, on hepatic and splenic injury in ICR mice. Injury to lymphocytes and to hepatic Kupffer and endothelial cells occur within 3 hours, as indicated by marked increases in apoptosis in splenic follicles and hepatic Kupffer and endothelial cells; three to fourfold increases in serum aspartate transaminase were noted, as well. In adult male HsdBr1:WH Wistar rats, TBE, but not chloral hydrate or pentobarbital, reduced TNF α mRNA levels in spleen (Bette et al., 2004).

H. Steroids

1. Description

Anesthetic effects of steroids have been recognized for more than 60 years (Sutton, 1972). While a number of anesthetic steroids have been investigated, most work has focused on the combination of alphaxalone and alphadolone, introduced into human clinical practice in 1970 as Althesin, and for veterinary use as Saffan. Althesin is no longer available, and Saffan is not available in the US; it is licensed in the UK for use in cats and nonhuman primates, and has been used safely in a number of other species. Alphaxalone/alphadolone is characterized by a rapid induction of short-term anesthesia, with rapid recovery, a wide safety margin, and minimal accumulation with repeated doses (Jones, 1985). It has also been used for sedation or light anesthesia when administered intramuscularly (Branson, 2001).

Alphaxalone is insoluble in water, and alphadolone, a steroid with reduced anesthetic potency, has been added to increase solubility (Jones, 1985). The combination is poorly soluble in water, and requires dilution with an excipient (Saffan is prepared in 20% polyoxyethylated castor oil (Cremophor-EL)) for clinical use. Historically, alphadolone was used solely to increase solubility; recent studies have demonstrated antinociceptive effects, without sedation, when administered IP (Nadeson and Goodchild, 2001).

Most of the reported side effects of alphaxalone/alphadolone have been attributed to Cremophor, which induces histamine release and may result in major anaphylactic reactions. This led to withdrawal of Althesin from the market, and its contraindication for use in dogs (Ferre et al., 2006). Allergic reactions are also commonly observed in cats (Branson,

2001). A new formulation of alphaxalone (Alfaxan), without alphadolone, uses 2-hydroxypropyl-beta cyclodextrin as a solubilizing agent. It has been approved for use in dogs and cats in Australia (Ferre et al., 2006) and is safe and effective in pigs (Keates, 2003). New steroid preparations may provide improved alternatives to available products (Sear, 1996).

2. Biodisposition

Induction is almost immediate following IV administration of alphaxalone/alphadolone in the rat. Duration is dose-dependent, but generally short, and recovery is rapid. Alphaxalone plasma half-life is approximately 7 minutes and serum protein binding about 40%. Excretion of the steroids is rapid, through both feces and urine. Following IV injection, 76.5% of a radiolabeled dose can be recovered from bile within 3 hours of injection; fecal excretion continues for several days, suggesting enterohepatic circulation of the steroid metabolites. The principal metabolite in rats apparently is a glucuronide of 2 α -hydroxyalphaxalone. A similar plasma half-life is seen in the mouse and monkey (Child et al., 1972a).

Both alphaxalone and alphadolone have anesthetic activity following IV administration, although alphadolone is only about one-third as potent; both drugs act at the GABA_A receptor (Ferre et al., 2006; Nadeson and Goodchild, 2001). Alphaxalone, but not alphadolone, is also active by IP administration. Alphadolone (but not alphaxalone) has antinociceptive effects, but only when administered IP or orally. This suggests production of an active metabolite in the liver (Winter et al., 2003). Other groups have demonstrated analgesic effects of alphaxalone (Gilron and Coderre, 1996), mediated in part via T-type Ca²⁺ channels (Pathirathna et al., 2005). Anxiolytic effects also can be demonstrated, and may have a site of action independent of the benzodiazepine site on the GABA_A receptor complex (Britton et al., 1991).

3. Pharmacologic Effects

Alphaxalone–alphadolone has anticonvulsant effects in rat epilepsy models, but only at hypnotic/anesthetic doses; this pattern resembles that of pentobarbital (Peterson, 1989). In contrast to anticonvulsant effects, a high incidence of myoclonic jerks occurs in mice following alphaxalone/alphadolone administration (File and Simmonds, 1988).

In humans, induction with alphaxalone/alphadolone may result in hiccoughs, coughing, laryngospasm and involuntary muscle movements (Sear, 1996). Transient hypotension may follow IV alphaxalone/alphadolone administration in cats, sheep, and pigs (Branson, 2001). In the rat, cardiac output is decreased (Gumbleton et al., 1990a) and blood pressure is decreased (Wang et al., 1991) or unchanged (Faber, 1989). Renal and hepatosplanchnic blood flows were highest among five anesthetic regimens evaluated and most nearly those in conscious

animals (Gumbleton et al., 1990a). There is an enhanced pressor response to administration of a nitric oxide inhibitor (Wang et al., 1991).

In pigs, there are minimal changes in blood gas values following alphaxalone/alphadolone administration (Glen, 1980), although transient apnea occurs in some animals (Branson, 2001). Surgical anesthesia in squirrel monkeys results in reduced body temperature and respiratory rate (Lögberg, 1988); in cynomolgus monkeys, there is a rapid decrease in temperature without change in respiratory rate (Box and Ellis, 1973). Gentamicin clearance and glomerular filtration rate in rats are similar to those in conscious controls (Gumbleton et al., 1990b).

Alphaxalone/alphadolone (4–6 mg/kg) has been recommended for use in cats undergoing cesarean section because it undergoes rapid clearance from the circulation and produces minimal respiratory depression (Seymour, 1999). Anecdotally, kittens delivered by cesarean section using alphaxalone/alphadolone are reported to appear sleepy (Duke, personal communication, 2005). There are currently no outcome studies evaluating the use of alphaxalone/alphadolone for feline cesarean section.

Hormonal and reproductive effects of alphaxalone/alphadolone are minimal, although weak antiestrogenic activity can be demonstrated (Child et al., 1972b).

I. Benzodiazepine Derivatives

1. Description

The term benzodiazepine refers to the portion of the chemical structure composed of a benzene ring fused to a seven-member diazepine ring. Because all clinically important benzodiazepines contain a 5-aryl substitution and a 1,4-diazepine ring, the term means the 5-aryl-1,4-benzodiazepine structure. Midazolam is an imidazobenzodiazepine, as is the benzodiazepine antagonist flumazenil. The triazolobenzodiazepines, such as alprazolam, are less commonly used in veterinary medicine.

Although benzodiazepines can produce marked sedation in rodents, pigs, and primates, they are not analgesic. Unlike most GABA_A agonists, benzodiazepines do not produce a true general anesthetic state, because awareness usually persists and relaxation sufficient to permit surgery cannot be achieved even with high doses. A variety of benzodiazepines are used in human medicine for their sedative, anxiolytic, spinal cord-mediated skeletal muscle relaxant, anticonvulsant, and antero-grade (acquisition or encoding of new information) amnesic properties. Although not capable alone of general anesthesia, uses include preanesthesia and anesthesia induction and they may be part of a balanced anesthesia regimen (Rall, 1990). Current veterinary use is limited largely to diazepam, midazolam, and zolazepam, typically in combination with another agent

(e.g., a hypnotic or dissociative) for anesthesia or anesthetic induction.

Diazepam is insoluble in water; parenteral solutions for IV injection include propylene glycol and ethanol. The solution is viscous, with a pH of 6.6–6.9. Dilution with water or saline produces cloudiness, but does not affect the drug potency. Thrombophlebitis is reported (Booth, 1988b; Hall and Clarke, 1991a), and propylene glycol interferes with drug absorption following intramuscular (IM) administration. Diazepam is also available in a soybean formulation, Diazemuls, for IV injection. Midazolam is chemically similar to diazepam, but has a pK of 6.15 which permits the preparation of water-soluble salts. Parenteral midazolam solution is buffered to pH 3.5; this is important because the lipid and water solubilities of midazolam are reversibly pH-dependent. At pH < 4.0, midazolam exists as a water-soluble open ring, but the ring closes and midazolam becomes a lipid-soluble drug at pH > 4.0. Midazolam is compatible with lactated Ringer's solution and can be mixed with the acidic salts of other drugs, including opioids and anticholinergics. Zolazepam is a water-soluble benzodiazepine that is combined with the dissociative agent tiletamine as the veterinary product Telazol (Ilkiw, 1992; Lin, 1996).

2. Biodisposition

Benzodiazepines are well-absorbed following intranasal or oral administration and rapidly enter the CNS and other highly perfused organs following IV administration. Differences in the onset and duration of action reflect differences in receptor-binding affinity, lipid solubility, and pharmacokinetics. All benzodiazepines are highly lipid soluble and bound to plasma proteins, particularly albumin. Benzodiazepine metabolism is prolonged in the presence of drugs that inhibit cytochrome P450 (e.g., cimetidine, erythromycin, calcium channel blockers, antifungal drugs, etc.).

Rall (1990) provides a detailed discussion of benzodiazepine metabolism in humans. Diazepam shows a biexponential decline in plasma following IV administration. There are species-specific differences in elimination half-life from approximately 1 to 7 hours in the rat, guinea pig, rabbit, and dog; by comparison, the value in humans is 33 hours. In the rat, rabbit, and dog, blood clearance rate exceeds liver blood flow, suggesting extrahepatic elimination (Klotz et al., 1976). The major metabolite of diazepam is the active metabolite *N*-desmethyl-diazepam (nordiazepam) (Booth, 1988b).

Diazepam disappearance is monoexponential in rat, monkey and human hepatocytes, and best described by a 2-compartment process in dog hepatocytes. The hepatocytes of all studied species (Wistar rat, cynomolgus monkey, beagle dog, and humans) were found to produce nordiazepam and temezepam as metabolites, with nordiazepam representing the principal metabolite in the dog, monkey and human cells. In the dog, temezepam was found only as a minor metabolite. Oxazepam was a significant metabolite in the monkey and a minor

metabolite in the dog and human hepatocytes, but was not detected in rat cultures. The principal metabolite in rat cells was 4'-hydroxy diazepam, which was further rapidly metabolized to its glucuronide. The drug-metabolizing activities of the hepatocyte cultures toward diazepam were comparable with the in vivo drug metabolism in each species (Seddon et al., 1989).

Lacoste et al. (2000) reported the pharmacokinetics of midazolam following intranasal administration in pigs. In pigs weighing 18 kg, both 0.2 and 0.4 mg/kg intranasal midazolam caused equal and significant anxiolysis and sedation within 3–4 minutes. In 42 kg pigs administered 0.4 mg/kg, plasma concentrations attained a maximum (C_{max}) of 0.13 mg/L at 5 minutes (median T_{max}) and remained higher than 0.04 mg/L until 60 minutes. The intranasal bioavailability factor (F) was $F = 0.64$. The intranasal terminal half-life was comparable with the IV administration half-life. Midazolam is metabolized by cytochrome P450 (CYP3A4) enzymes to active and inactive metabolites. The active metabolite, 1-hydroxymidazolam, is conjugated to 1-hydroxymidazolam glucuronide and subsequently cleared through the kidneys.

Plasma half-life of zolazepam in dogs, cats, rats, and monkeys is 4–5 hours, 4.5 hours, 3 hours, and 1 hour, respectively. In beagle dogs, about 2.9–8.7% of administered zolazepam is detected in the urine and 1% is recovered in the feces. The major metabolite isolated from cat urine is 8-dimethyl-1,6-hydroxy-zolazepam [metabolite 5]. Two other metabolites, 8-dimethyl-zolazepam [metabolite 1] and 1,8-dimethyl-zolazepam [metabolite 3], are also found in cat urine after a single dose. In beagle dogs, 1-dimethyl-zolazepam [metabolite 2] and a hydroxylated derivative of metabolite 2 [metabolite 6] are found in urine. Six-hydroxy-zolazepam [metabolite 4] is found in both male and female rats, while metabolite 2 is found only in female rats (Lin, 1996).

3. Pharmacologic Effects

There are considerable species-specific differences in the pharmacologic profile of the benzodiazepines (Rall, 1990). Tranquilizing effects of the benzodiazepines are species-variable, and excitation may follow administration (Booth, 1988b; Hall, Clarke, and Trim, 2001; Rehm and Schatzman, 1986). In animal models of anxiety, benzodiazepines increase locomotor, feeding, and drinking activity that is suppressed by novel or aversive stimuli (Charney et al., 2006). In chickens, diazepam alone has a slight tranquilizing effect (Christensen et al., 1987). In cats, zolazepam does not induce anesthesia or tranquilization when administered either IM or IV, and when administered at high doses (10 mg/kg), produces fear, continuous territorial exploration, and jumping–climbing reactions similar to those observed with high-dose midazolam (Lin, 1996). In mice, zolazepam induces a delayed increase in random motor activity, while in rats, zolazepam produces anxiolytic effects only within the range of 0.63–10 mg/kg; anxiolysis is not prominent at lower doses, while higher doses mask anxiolysis

with excessive depression (Lin, 1996). Clomazepam has been used in several domestic species (Hall and Clarke, 1991a), and is reported to be an effective sedative in rats, although there is no loss of righting reflex or analgesic effect. There are significant strain and age differences in response (West and Green, 1987). The existence of multiple benzodiazepine receptors may explain the diversity of pharmacological responses in different species.

Benzodiazepines in general have minimal cardiovascular effects and mild respiratory effects (Booth, 1988b). Diazepam in rabbits and mice leads to respiratory depression only at lethal doses (Bradshaw and Pleuvry, 1971). In rabbits, the LD₅₀ for IV diazepam is 60 mg/kg (Thurmon et al., 1996). In swine, midazolam results in decreased respiratory rate, but blood gas values are maintained (Smith et al., 1991). Information on cardiorespiratory effects of zolazepam is limited, but 10 mg/kg IM is reported to increase heart rate and have minimal effects on respiration in cats (Lin, 1996).

Diazepam does not decrease blood pressure in guinea pigs (Flynn et al., 1988). In dogs, IV diazepam (0.5, 1.0, 2.5 mg/kg) does not alter heart rate or mean arterial pressure, but IV midazolam (0.25, 1.0, 10 mg/kg) increases heart rate and decreases mean arterial pressure at the highest tested doses (Jones et al., 1979). At the two higher doses, cardiac output increased 10–12% with midazolam and left ventricular dP/dt_{max} (a measure of contractility) decreased 13–16%. Diazepam (1.0 and 2.5 mg/kg) also produced a 17% decrease in left ventricular dP/dt_{max} , and 2.5 mg/kg produced a 10% increase in cardiac output. Neither diazepam nor midazolam in any dosage altered regional coronary blood flow, systemic or coronary vascular resistance, stroke volume, or stroke work. Decreased myocardial contractility also occurs in swine at higher doses of midazolam (Smith et al., 1991). Direct negative inotropic effects have been demonstrated in vitro, but are dose-dependent and may not reflect concentrations encountered clinically (Stowe et al., 1992). In awake adult beagle dogs, 2 mg/kg IV zolazepam causes no changes in cardiovascular function, while 10 and 50 mg/kg decreased systemic vascular resistance, decreased blood pressure, and produced a reflex tachycardia (Lin, 1996). Increasing, cumulative doses of midazolam in the pig result in a progressive decline in heart rate, but arterial pressure is increased and cardiac output maintained (Smith et al., 1991).

Benzodiazepine receptors are present in the periphery (Booth, 1988b). Peripheral benzodiazepine receptors (PBRs) are abundant in the cardiovascular system (see review by Veenman and Gavish, 2006). In the cardiovascular lumen, PBRs are present in platelets, erythrocytes, lymphocytes, and mononuclear cells. In the walls of the cardiovascular system, PBR can be found in the endothelium, the striated cardiac muscle, the vascular smooth muscles, and the mast cells. The subcellular location of PBR is primarily in mitochondria. Putative PBR functions include regulation of steroidogenesis, apoptosis, cell proliferation, the mitochondrial membrane potential, the mitochondrial respiratory chain, voltage-dependent calcium channels, responses to stress, and microglial activation. PBRs in blood vessel

walls appear to take part in responses to trauma such as ischemia.

Benzodiazepines decrease adenosine degradation by inhibiting the nucleoside transporter, which is the principal mechanism by which the effect of adenosine is terminated through re-uptake into cells (Seubert et al., 2000). Adenosine is an important regulator of cardiac function. It reduces cardiac oxygen demand by slowing heart rate, and increases oxygen delivery through coronary artery vasodilation, thus providing cardioprotection during myocardial ischemia. In a model of ischemic myocardial preconditioning, midazolam does not affect cardiac myocyte K_{ATP} channel activity (Zaugg et al., 2002).

Benzodiazepines should be used cautiously, if at all, in animals presenting for cesarean section. Rapid placental transfer with significant fetal uptake occurs with these agents and elimination from the newborn is quite slow. In human obstetrical practice, maternal benzodiazepine administration prior to or during labor is associated with lower Apgar and neurobehavioral scores and “floppy infant syndrome,” with symptoms ranging from mild sedation, hypotonia, and reluctance to suck, to apneic spells, cyanosis, and impaired metabolic responses to cold stress (Celleno et al., 1993; McElhatton, 1994). Similar depression of neurological reflexes following midazolam–ketamine–enflurane anesthesia has been observed in puppies (Luna et al., 2004). Large IV doses of diazepam in pregnant mice results in high fetal losses (Rank and Jensen, 1989). Diazepam is also reported to produce hypothermia in aged squirrel monkeys (Clark and Lipton, 1981).

4. Immune System Effects

PBRs in blood cells appear to play roles in several aspects of the immune response, such as phagocytosis and the secretion of interleukin-2, interleukin-3, and immunoglobulin A (IgA) (see review by Veenman and Gavish, 2006). In addition, the central benzodiazepine receptor may contribute to the regulation of T-cell function by modulating the activity of the hypothalamo-pituitary-adrenocortical axis, the sympathoadrenal system, or both, which, in turn, exert a significant effect on immune function (Zavala, 1997). Benzodiazepines bind to primary human microglial cells, the principal site of HIV-1 replication in the brain, and inhibit LPS-induced TNF α production by these cells in a concentration-dependent manner. Treatment of HIV-1-infected primary human microglial, as well as mixed glial/neuronal, cell cultures with benzodiazepines inhibits the expression of HIV-1 p24 antigen (Lokensgard et al., 1998). Benzodiazepine-induced inhibition of HIV-1 expression in chronically infected promonocytic (U1) cells has been found to be associated with decreased activation of the nuclear transcription factor kappa B (Lokensgard et al., 1998). Midazolam impairs neutrophil function at clinically relevant concentrations (Nishina et al., 1998). Both the humoral and cell-mediated immune response of adult rats can be altered by administering

diazepam prenatally or in early postnatal life (Dostal et al., 1995; Schlumpf et al., 1992).

5. Antagonists

Flumazenil is a specific benzodiazepine antagonist that attenuates the central effects of the benzodiazepines. In the absence of an agonist for the benzodiazepine-binding site, flumazenil itself does not affect GABA_A-receptor function. Studies of the antagonistic effects of flumazenil in humans, rats, and mice have been reviewed (Brogden and Goa, 1991). The effectiveness of flumazenil reversal appears to vary with species, as Ilkiw et al. (2002) found that IV flumazenil (0.001, 0.005, 0.01, and 0.1 mg/kg) did not shorten or improve recovery from ketamine (3 mg/kg) and midazolam (0.05 mg/kg) anesthesia in cats. The behavioral and electrophysiological effects of the benzodiazepines can also be reduced or prevented by prior treatment with GABA-binding site antagonists, such as bicuculline. Physostigmine has been reported as a nonspecific antidote in rats, rabbits, and cats (Nagy and Desci, 1978).

III. *N*-METHYL-D-ASPARTATE (NMDA) ANTAGONISTS

A. Mechanism of Action

The neuropharmacology of the phencyclidine derivatives is complex, with interactions at *N*-methyl D-aspartate (NMDA) and non-NMDA glutamate/nitric oxide/cGMP receptors, as well as nicotinic and muscarinic cholinergic, and monoaminergic and opioid receptors (Kohrs and Durieux, 1998). Although ketamine does weakly bind at GABA receptors, NMDA receptor antagonism accounts for most of its analgesic effects (Kohrs and Durieux, 1998; Pozzi et al., 2006). Glutamate and its analog, NMDA, are excitatory amino acids. Group 1 metabotropic glutamate receptors are reported to regulate NMDA receptor function (Sou et al., 2006). In addition, interactions with voltage-dependent Na⁺ and L-type Ca⁺⁺ channels have been described. When glutamate occupies the binding site on the NMDA subtype of the glutamate receptor in the presence of glycine, the ligand-gated (ionotropic) channel opens, allowing Ca⁺⁺, Na⁺, and K⁺ to either enter or leave the cell, which leads to postsynaptic neuronal depolarization. Ketamine binds to the phencyclidine receptor in the NMDA channel and prevents further ion flux, thus inhibiting glutamate activation of the channel in a noncompetitive manner. The blockade is time-, concentration-, and stimulation frequency-dependent. The phencyclidine-binding site partly overlaps with a binding site for Mg⁺⁺. In addition, ketamine can produce a mild local anesthetic effect through neuronal Na⁺ channel inhibition, as well as cerebral vasodilation through Ca⁺⁺ channel inhibition.

B. Cyclohexamines

1. Description

The cyclohexamine anesthetics, phencyclidine and its congeners ketamine and tiletamine, have been categorized as dissociative anesthetics and sympathomimetic anesthetics (Soma, 1983). "Dissociative" refers to the apparent dissociation of the patient from its environment, believed to be caused by interruption of CNS impulses as well as differential depression and activation of various areas of the brain (Muir, 1985; Reich and Silvey, 1989). The anesthetic action of ketamine requires a functioning cerebral cortex (Wright, 1982). There is depression or disorganization of the associative areas of the brain, while subcortical areas may be activated (Haskins, 1992; Oguchi et al., 1982). The subject seems completely unaware of the environment, and suggested mechanisms include electrophysiologic inhibition of the thalamocortical pathways and stimulation of the limbic system. Ocular and pharyngeal reflexes are retained, or attenuated less, with ketamine than with other anesthetic agents, which can make traditional monitoring of anesthetic depth using observation of physical signs misleading. The pharmacology of ketamine and tiletamine, as well their use in veterinary medicine, has been reviewed (Lin, 1996; Lin et al., 1993).

The wide veterinary use of ketamine stems from its low cost, wide margin of safety, ease of administration, and initial introduction as a Drug Enforcement Administration noncontrolled anesthetic (presently DEA Class III). Tiletamine was initially developed in an effort to find an agent with potency and duration intermediate between phencyclidine and ketamine. Its current use in veterinary medicine is primarily in a 1:1 combination with the benzodiazepine zolazepam, marketed as the product Telazol (see Anesthetic Combinations, Section VIII.B). One textbook of veterinary anesthesia lists more than 75 species under the index term "ketamine" and more than 105 species under the index term "Telazol" (Thurmon et al., 1996).

Ketamine is water-soluble and structurally resembles phencyclidine. The presence of an asymmetric carbon atom produces two optical isomers, *R*(−) and *S*(+); these isomers differ in anesthetic potency and effect (Muir and Hubbell, 1988; Reich and Silvey, 1989; Ryder et al., 1978). Commercial racemic mixtures of ketamine consist of equal parts of the *R*(−) and *S*(+) isomers; however, *S*(+) ketamine is commercially available. *S*(+) ketamine produces more intense analgesia, more rapid metabolism and recovery, less salivation, and a lower incidence of emergence reactions than *R*(−) ketamine. *S*(+) ketamine has analgesic potency approximately twice that of racemic ketamine and four times greater than *R*(−) ketamine. Like cocaine, both ketamine isomers inhibit postganglionic sympathetic nerve re-uptake of catecholamines.

Ketamine is generally considered to be a potent analgesic, blocking conduction of pain impulses to thalamic and cortical areas. Although analgesia is reportedly more effective for procedures involving the musculoskeletal system than the abdomen

(Wright, 1982), NMDA-antagonists have been shown to provide visceral analgesia in animals as well as humans (Olivar and Laird, 1999; Strigo et al., 2005). Ketamine has recently re-emerged as an important drug for prevention and management of chronic pain, as spinal cord dorsal horn NMDA receptors are important mediators in the "wind-up" chronic pain phenomenon.

2. Biodisposition

Ketamine has high lipid solubility, a pK of 7.5 at physiologic pH, and is associated with rapid induction and return to consciousness following redistribution from the CNS to other body tissues (Thurmon, 1985). The 10% aqueous solution has a pH of 3.5, which may result in pain on injection and muscle necrosis in small animals (Wright, 1982). It has high bioavailability following IV or IM administration (Reich and Silvay, 1989), although IM injection may result in more variable peak plasma concentrations (Löscher et al., 1990). It is not significantly bound to plasma proteins, leaves the blood rapidly following injection, and is initially distributed to highly perfused tissues, such as the brain, where its high lipid solubility ensures rapid transfer across the blood-brain barrier. It is subsequently redistributed away from the brain to other less well-perfused tissues.

Ketamine is metabolized by the liver in most species. The most important pathway is *N*-demethylation by cytochrome P450 to norketamine (metabolite I), an active metabolite with one-third to one-fifth the initial activity. Norketamine is hydroxylated and conjugated to water-soluble products that are excreted by the kidney; reduced renal output can thus result in prolonged ketamine action. The cyclohexanone ring also undergoes oxidative metabolism. The so-called metabolite II is apparently not a naturally occurring *in vivo* metabolite, but a by-product of the chromatographic process (Reich and Silvay, 1989). Ketamine pretreatment decreases the plasma half-life of intravenously administered ketamine by induction of hepatic microsomal enzyme activity (Marietta, 1977). Tolerance has been demonstrated in rats (Livingston and Waterman, 1978) and is recognized in human clinical practice (Reich and Silvay, 1989).

Peak brain levels of ketamine are reached within 1 minute following IV injection in the rat, and brain:plasma ratios remain at 6.5:1 for more than 10 minutes (Cohen et al., 1973). Over half of an oral, IM, or IP dose of radiolabeled ketamine in the rat is recovered in urine and feces within 24 hours. By 72 hours, 53–75% is recovered in urine and 23–25% in feces. Ketamine is transferred readily across the placenta in dogs, monkeys, and humans (Chang and Glazko, 1974). There are significant species differences in the relative amounts of free ketamine and ketamine metabolites in the urine (Chang and Glazko, 1974), and protein binding in serum (Wright, 1982). Löscher et al. (1990) present a detailed analysis of pharmacokinetic data in swine, compared with the data in other domestic species.

Tiletamine produces excitation in mice and rats at low doses; at higher doses, anesthesia may be produced in these species, but not in rabbits or guinea pigs (Chen et al., 1969). Plasma half-life of tiletamine in cats is 2–4 hours; in dogs, monkeys, and rats, it is 1.2 hours, 1–1.5 hours, and 30–40 minutes, respectively (Lin, 1996). Single IM injection of high doses of tiletamine in rabbits results in significant elevations in BUN and creatinine. At lower doses, there are no changes in serum chemistry values, but mild nephrosis is evident histologically in most animals (Doerning et al., 1992).

3. Pharmacologic Effects

a. Route of Administration and Cardiovascular Effects

Ketamine can be administered intravenously, intramuscularly, or intraperitoneally. There is, however, concern that IM injection of ketamine can cause discomfort and tissue reactions in small rodents and, therefore, this route should be avoided (Flecknell, 1996; Wixson and Smiler, 1997). Ketamine potentiates stress-induced ulcers in the stomach of rats, presumably due to splanchnic vasoconstriction (Cheney et al., 1974).

The cardiovascular effects of ketamine are modified by concurrent administration of other anesthetic agents. Ketamine *in vitro* causes direct myocardial depression (Schwartz and Horwitz, 1975). Because of its receptor profile, however, ketamine increases myocardial contractility through increased sympathetic nervous system activity, and ketamine administration to dogs and cats typically increases hemodynamic variables (Muir, 1985; Wright, 1982). The sympathetically mediated positive inotropic and chronotropic effects of ketamine can be blocked by inhaled anesthetics, ganglionic blockade, cervical epidural anesthesia, and spinal cord transection (Stanley, 1973; Traber et al., 1970). Baroreceptor reflex response is altered in ketamine-anesthetized rats (Wang et al., 1991) and rabbits (Blake et al., 1982). The vasoconstrictor response to hemorrhage is suppressed compared with conscious animals (Van Leeuwen et al., 1990). Cardiohemodynamics in the rhesus macaque have been reported (Booker et al., 1982; Ochsner, 1977; Reutlinger et al., 1980).

Decreased myocardial contractility with anesthetic doses of ketamine *in vivo*, and in isolated cardiac preparations (Dowdy and Kaya, 1968; Parker and Adams, 1978), may explain negative inotropic and chronotropic effects seen in pithed rat and rabbit preparations (Clanachan et al., 1976). Conflicting data on the *in vitro* inotropic effects of ketamine may be due to differences in species, tissue preparation, or temperature or calcium concentration of the medium (Stowe et al., 1992). A direct negative inotropic effect is usually overshadowed *in vivo* by central sympathetic stimulation. The arrhythmogenic potential of ketamine remains controversial (Reich and Silvay, 1989).

Ketamine alone results in a short vasodepression followed by a longer lasting strong pressor response (Altura et al., 1980).

Increases in heart rate and mean arterial pressure have been reported following ketamine administration in rats and rabbits (Kumar and Kumar, 1984; Wang et al., 1991). Other studies in rabbits have found an elevated heart rate (Dhasmana et al., 1984), and decreased arterial pressure and cardiac output (Van Leeuwen et al., 1990). The effect of ketamine on cardiac output of the rat has been variable (Idvall et al., 1980; Miller et al., 1980). In nonhuman primates, ketamine administration has resulted in an unchanged heart rate, mean arterial pressure, and rectal temperature (Reutlinger et al., 1980), or cardiodepression (Chimoskey et al., 1975; Ochsner, 1977).

Ketamine has been reported to open arteriovenous shunts in rats (Miller et al., 1980) and pregnant guinea pigs (Mårtensson and Carter, 1984), such that microsphere-based methods of determining cardiac output and organ perfusion may be unreliable. Miller et al. (1980) reported that trapped microspheres were released from muscle and skin in Wistar rats given 125 mg/kg ketamine IP, resulting in an apparent decrease in the distribution of cardiac output to muscle and an apparent increase in flow to the lung.

Pharmacologic activation of adenosine triphosphate-regulated potassium (K_{ATP}) channels mimics ischemic preconditioning and decreases infarct size or improves functional recovery of ischemic-reperfused stunned myocardium. Racemic ketamine blocks K_{ATP} channels in isolated cardiac cells and abolishes short-term cardioprotection against prolonged ischemia; this effect is due to the *R*(−) isomer but not the *S*(+) isomer (Molodjavi et al., 2001; Mullenheim et al., 2001b). In a cellular model of simulated myocardial ischemia, diazoxide-induced cell protection of mitochondrial K_{ATP} channel activity was mitigated by *R*(−) ketamine, but not by *S*(+) ketamine (Zaugg et al., 2002).

b. Effect on Ventilation and Blood Gases

The respiratory effects of ketamine itself are relatively minor, although a dose-dependent suppression can be demonstrated. A characteristic apneustic pattern of breathing is seen commonly (Muir, 1985; Wright, 1982). In rhesus monkeys, normal respiratory variables are maintained, except for transient elevations in arterial PCO_2 and venous PO_2 (Reutlinger et al., 1980). Low doses of ketamine in the rabbit result in decreased respiratory rate and PO_2 (Dhasmana et al., 1984). Ketamine sympathomimetic actions promote bronchial muscle relaxation, and protective airway reflexes are generally maintained (Thurmon and Benson, 1987). Anesthetic agents concurrently administered with ketamine, however, may have a significant effect on blood gases (see Anesthetic Combinations, Section VIII.B).

c. Tolerance and Strain Differences

There are age and sex differences in the response of rats to ketamine (Waterman and Livingston, 1978). Ketamine sleeping

time decreases as young rats mature from 1 to 3 weeks. This decrease in sleeping time seemed to be associated with the increased production of the cyclohexanone oxidation metabolite of ketamine, norketamine. After 3 weeks, females sleep longer in response to ketamine than males; again, which may be due to a greater ability of the male to produce the cyclohexanone oxidation metabolite.

d. Effects on Blood Glucose Levels

Blood glucose levels following an IV glucose challenge are increased by ketamine (Aynsley-Green et al., 1973; Hsu and Hembrough, 1982; Reyes Toso et al., 1995).

e. Nervous System

Ketamine is traditionally considered to increase CBF and ICP (Wright, 1982), while CBF in the rabbit is increased without elevated PCO_2 (Dhasmana et al., 1984). However, direct cerebral vasodilation has not been a consistent finding, likely because many early studies were performed on spontaneously breathing subjects (Reich and Silvey, 1989). When ventilation is not controlled, ICP may rise following vasodilation secondary to hypercapnia (Pfenninger et al., 1985; Schwedler et al., 1982; Tranquilli et al., 1983). Using nuclear magnetic resonance perfusion imaging and electron paramagnetic resonance oximetry, Lei et al. (2001) found that in ventilated rats, ketamine at a dose of 50 mg/kg does not induce significant changes in CBF and increases cortical O_2 partial pressure.

In the human clinical setting, ketamine does not increase ICP when used under conditions of controlled ventilation, coadministration of a $GABA_A$ agonist, and without nitrous oxide (Himmelseher and Durieux, 2005). Compared with other anesthetics or sedatives, level II and III evidence (level II—evidence from at least one randomized clinical trial; level III—evidence from nonexperimental descriptive studies, such as comparative studies, correlation studies, and case control studies) indicates that hemodynamic stimulation induced by ketamine may improve cerebral perfusion; this could make the drug a preferred choice after brain injury. In the laboratory, racemic ketamine has neuroprotective, and *S*(+)-ketamine additional neuroregenerative effects, even when administered after onset of a cerebral insult. However, improved outcomes were only reported in studies with brief recovery observation intervals. In developing animals, and in certain areas of the brain in adult rats without cerebral injury, neurotoxic effects were noted after administration of large doses of ketamine; these were prevented by coadministration of $GABA$ receptor agonists (Himmelseher and Durieux, 2005).

Although ketamine and tiletamine have been reported to induce seizures in dogs and cats (Chen et al., 1969; Garmer, 1969; Wright, 1982), these agents raise the threshold to chemically or electrically induced seizures in rats and mice (Chen et al., 1969; Myslobodsky et al., 1981). Ketamine does not

alter seizure threshold in epilepsy (Celesia et al., 1975), and induces excitatory activity in both the thalamus and limbic systems without evidence of spread to cortical areas (Ferrer-Allado et al., 1973). Thus, ketamine is unlikely to precipitate generalized convulsion even in the presence of pre-existing seizure disorders. Myoclonic- and seizure-like activities may be observed; however, ketamine is considered to have anticonvulsant activity because EEG evidence of cortical epileptic activity is absent (Modica et al., 1990).

The classical stage 2 excitement phase, which occurs with subanesthetic concentrations of ketamine, may be associated with general stimulation of a variety of G-protein-linked receptors. The high-affinity states of dopamine D2 and D3 receptors, serotonin 5HT-2A receptors, beta2-adrenoceptors, alpha2-1 and alpha2-2 adrenoceptors, opiate receptors, and muscarinic receptors are inhibited *in vitro* by clinical concentrations of ketamine; subanesthetic ketamine concentrations stimulate the incorporation of GTP into cloned dopamine D2 receptors (Seeman and Kapur, 2003).

Other reported pharmacologic effects of ketamine include the following: bronchodilatory activity as effective as halothane or enflurane in preventing experimentally induced bronchospasm in dogs (Hirshman et al., 1979); dose-dependent hypothermia in rats (Lin et al., 1978); maintained thermal balance in rhesus monkeys (Hunter et al., 1981); marked (normal) salivation response to hyperthermia, in contrast to five other anesthetic regimens (Furuyama et al., 1989); increased serum renin activity (Pettinger et al., 1975); altered serum follicle-stimulating hormone, testosterone and androstenedione in rats following decapitation (Nazian, 1988); resting myopia in humans and nonhuman primates, due largely to central parasympathetic neuronal tone (Crawford et al., 1990); enhancement of neuromuscular blockade in humans (Reich and Silvy, 1989), and in rabbits (Bogdan et al., 1974) and monkeys (Tsai and Lee, 1989); teratologic effects in rats (Kochhar et al., 1986); muscle necrosis following IM injection of ketamine-xylazine in hamsters (Gaertner et al., 1987) and rabbits (Beyers et al., 1991); autoamputation of digits following ketamine-acepromazine injections in guinea pigs (Latt and Echobichon, 1984).

f. Immune System Effects

Ketamine does not impair neutrophil function at clinically relevant concentrations (Nishina et al., 1998). Ketamine inhibits platelet aggregation in baboons (Atkinson et al., 1985) and humans, possibly due to suppressed formation of inositol 1,4,5-triphosphate and subsequent inhibition of cytosolic free calcium concentrations (Nakagawa et al., 2002). Small decreases in hematocrit and plasma protein, with a larger decrease in leukocyte (principally lymphocyte) count are observed, compared with values in manually restrained animals (Loomis et al., 1980).

In primary cultures of rat glial cells stimulated with LPS in the presence of ketamine, TNF α production is reduced without

significant inhibition of nitrite release in mixed glial cells, astrocyte cultures and microglial cultures. Ketamine also inhibits LPS-induced production of prostaglandin E2 in astrocyte cultures (Shibakawa et al., 2005). It inhibits endotoxin-induced production of TNF α , IL-1, and IL-8 and increases IL-10 release *in vitro*; it also prevents TNF α , IL-1, and IL-6 responses to endotoxemia *in vivo* (Taniguchi and Yamamoto, 2005). The activation of nuclear factor-kappaB by endotoxin is also suppressed.

4. Ketamine Antagonists

Ketamine anesthesia is antagonized in mice by agonist drugs specifically targeting the metabotropic glutamate receptors 1 and 5 (Sou et al., 2006). Reich and Silvy (1989) discuss a number of agents which, based on the proposed mechanisms of action, should antagonize cyclohexamine effects. These agents include metaphit (1-(1-(3-isothiocyanatophenyl)-cyclohexyl)-piperidine; acetylates NMDA receptors), naloxone (opioid antagonist), norepinephrine and serotonin receptor blockers, and anticholinesterase agents (e.g., 4-aminopyridine or physostigmine) (Reich and Silvy, 1989; Wright, 1982).

IV. ALPHA2-ADRENOCEPTOR AGONISTS

A. Mechanism of Action and General Description

Alpha2-adrenoceptor-mediated sedation and antinociception has been reviewed (Maze and Regan, 1991; Maze and Tranquilli, 1991; Lamont and Tranquilli, 2002). The alpha2-agonists stimulate central alpha2-adrenoceptors; however, alpha2-adrenoceptor subtype expression and function appears to be species-specific, making extrapolation between species difficult (Ongioco et al., 2000). Three distinct human alpha2-adrenoceptor subtype genes or complementary DNA have been cloned and named alpha2-C10 (also known as alpha2_A in the earlier pharmacologic nomenclature), alpha2-C4 (or alpha2_B), and alpha2-C2 (or alpha2_C) according to their location on human chromosomes 10, 4, and 2 (Aanta et al., 1995), respectively. Related alpha2-adrenoceptor subtypes have been cloned from a variety of other species, including rat, mouse, pig, opossum, and fish, while partial cDNA sequences for bovine and avian alpha2-receptors have been identified. A fourth alpha2-adrenoceptor subtype has been proposed in the rat (alpha2_D); however, this is thought to be a species homolog of the rat alpha2_A subtype (Aanta et al., 1995). Studies in rats and mice have shown that the alpha2_A subtype is predominant and widely distributed in the brain. Both alpha2_A and alpha2_C subtypes have been identified in the rat spinal cord, with alpha2_A widely distributed and alpha2_C restricted mainly to the dorsal root ganglia. In human spinal cord, however, the alpha2_A and alpha2_B subtypes predominate, with the alpha2_C subtype only

sparsely represented (Maze and Fujinaga, 2000). Lakhiani et al. (1997) have detailed the use of a mouse “hit and run” genetic model to describe alpha2 receptor subtypes; the two-part technique consists of “hitting” cells with an inserted mutated gene and allowing the recombination event to “run,” thus activating the inserted gene.

Analgesia results from a combination of direct activation of alpha2-adrenoceptors located within the spinal cord, and sedative-hypnotic effects activated by supraspinal alpha2-autoreceptors (alpha2-adrenoceptors on noradrenergic neurons) within the brainstem (catecholaminergic nuclei of the pons A5, A6—also called the locus ceruleus—and A7) (Stenberg, 1989). Spinal antinociception occurs when presynaptic alpha2 non-noradrenergic neurons (heteroceptors) in the dorsal horn are activated by norepinephrine or an exogenous alpha2-agonist. Antinociception involves both alpha2-autoreceptors throughout the CNS as well as alpha2-heteroceptors in the dorsal horn of the spinal cord. When these heteroceptors are activated, G_o proteins mediate a reduction in calcium influx, leading to decreased release of neurotransmitters and/or neuropeptides (such as glutamate, vasoactive intestinal peptide, calcitonin gene-related peptide, substance P, and neurotensin). Additionally, alpha2-heteroceptors are located postsynaptically on wide-dynamic range projection neurons targeted by primary afferent fibers in the dorsal horn. Ligand binding at these receptors produces neuronal hyperpolarization through G_i protein-coupled potassium channels and results in postsynaptically mediated spinal analgesia through dampened ascending nociceptive transmission. There is also evidence that supraspinal alpha2-agonist binding may contribute indirectly to spinally mediated alpha2-adrenoceptor-mediated antinociception (Pertovaara et al., 1991).

Alpha2-agonists are not anesthetics (although there may be species differences in this regard), nor are they tranquilizers in the strictest sense. As sole sedative/analgesic agents, alpha2-agonists have limited usefulness at any dose; effects are dose-dependent, such that administration of high doses prolongs sedation without increasing analgesia. They are commonly used alone as sedative/analgesic agents, combined with other anesthetic agents, or administered as constant rate infusions at very low dosages for anxiolysis/analgesia. The most commonly used alpha2-agonists, xylazine, detomidine, medetomidine, and romifidine, are most effective when combined with opioids or dissociative anesthetics (see Anesthetic Combinations, Section VIII.B) (Booth, 1988b; Kastner, 2006; Lamont and Tranquilli, 2002).

Marked variation in sensitivity is seen between species. Cattle are reported to be 10 times more sensitive to xylazine than horses or dogs, but as sensitive to medetomidine as dogs, and equally or less sensitive to detomidine as horses; swine are very resistant to all alpha2-agonists (England and Clarke, 1996; Hall et al., 2001). Variation in specificity for alpha2 and alpha1 receptors may explain some of the clinical differences observed. Xylazine has an alpha2/alpha1 receptor-binding ratio of 160; in

comparison, the ratio for medetomidine, detomidine, and clonidine is 1,620, 260, and 220 (Virtanen, 1989), respectively. The alpha2-agonist clonidine, used primarily as an antihypertensive in human medical practice, has been extensively studied in animals.

Absorption rate is similar for all clinically used alpha2-agonists. At equipotent doses, differences between individual agents exist mainly in length of action, sedative and analgesic properties, and in the extent and significance of side effects. Common cardiovascular side effects include dose-dependent bradycardia (MacDonald and Virtanen, 1992; Ruskoaho and Leppäluoto, 1989; Venugopalan et al., 1994). The mechanism involves central, sympathetic effects at lower doses and peripheral vagal effects at higher doses (MacDonald and Virtanen, 1992). Second-degree atrioventricular block has been observed in dogs (Vainio, 1989). There is typically a transient increase in blood pressure following medetomidine administration, attributed to peripheral alpha2 effects, and a subsequent decrease which is probably centrally mediated. This pattern has been observed in dogs, chloralose-anesthetized cats, pentobarbital-anesthetized rats, and conscious spontaneously hypertensive (SHR) rats (Savola, 1989; Vainio, 1990; Venugopalan et al., 1994). Others have reported unchanged blood pressure in cynomolgus monkeys at sedative doses (Mann et al., 1991) and in SHR rats (Ruskoaho and Leppäluoto, 1989). Cardiac output is decreased due to increased systemic vascular resistance and decreased heart rate; this can be beneficial in the presence of hypertrophic cardiomyopathy and left ventricular outflow tract obstruction (Lamont et al., 2002). Respiratory suppression is variable and related to adjunctive anesthetic agents (see Anesthetic Combinations, Section VIII B). Hypoxemia is reported in sheep, but incidence is highly variable and depends on individual or breed-related factors (Kastner, 2006).

Other common side effects include: decreased insulin release, diuresis and polyuria (Greene and Thurmon, 1988; Hsu et al., 1986); decreased gastrointestinal motility possibly due to localized inhibition of acetylcholine release (Greene and Thurmon, 1988; Hsu, 1982); and thrombasthenia (Haskins, 1992; Venn et al., 2001); inhibition of antidiuretic hormone, antagonism of renal tubular action, and increased glomerular filtration resulting in increased urine output (Maze et al., 1997; Miller et al., 2001; Saleh et al., 2005); hypothermia (MacDonald and Virtanen, 1992; MacDonald et al., 1989; Vainio, 1989); vomiting, especially in cats, and occasional muscle jerks (Vainio, 1989); suppressed gastric secretion in rats (Savola et al., 1989); hormonal changes, including transient alterations in GH, testosterone, prolactin, and follicle-stimulating hormone levels.

Medetomidine, dexmedetomidine, and detomidine are all imidazole derivatives; inhibition of steroidogenesis by imidazoles is well-described (see Section II.E). In dogs, basal cortisol levels decrease and the cortisol response to ACTH is blunted 3 hours after dexmedetomidine administration (Maze et al., 1991). Medetomidine and detomidine inhibit aldosterone, corticosterone, and cortisol release in porcine adrenocortical

cells; medetomidine, dexmedetomidine, and atipamezole inhibit mitochondrial cytochrome P450(11beta/18), unrelated to their alpha2-adrenoceptor actions (Jager et al., 1998). On the other hand, adrenal steroidogenesis was not affected in horses sedated with detomidine (Raekallio et al., 1991), humans sedated with dexmedetomidine (Venn et al., 2001), and ferrets (*Mustela putorius furo*) sedated with medetomidine (Schoemaker et al., 2003).

B. Xylazine

1. Description

Xylazine is a thiazole drug (Salonen, 1992) that is used alone or with other agents for sedation, immobilization and anesthesia; it is an approved drug in the US for use in cats, dogs, and horses. A lot of information is available on the clinical use of this agent in these (and other) domestic species (Benson and Thurmon, 1987; Greene and Thurmon, 1988), including the considerable variation in response among species.

2. Biodisposition

Xylazine is rapidly absorbed following IM administration, and rapidly and extensively metabolized (Salonen, 1992); elimination is relatively rapid (Salonen, 1992). Radiolabeled xylazine is rapidly distributed following IV injection in the rat, and 70% of the radioactivity may be recovered in urine, only 8% of which represents unchanged xylazine. The rapid metabolism of xylazine yields about 20 different metabolic products (Duhm et al., 1969, discussed by Garcia-Villar et al., 1981). Hepatic metabolism includes oxidation of the aromatic moiety and cleavage of the heterocyclic ring; no active metabolites have been reported (Salonen, 1992).

3. Pharmacologic Effects

As in most species, xylazine alone in mice does not produce sleep or loss of the righting reflex (Hsu, 1992). Analgesia following xylazine has been demonstrated in a variety of species including the rat and mouse (Browning et al., 1982; Schmitt et al., 1974). There is, in general, minimal effect of xylazine on the respiratory system (Greene and Thurmon, 1988). In rhesus monkeys, xylazine does not affect respiratory rate or blood gas values (Reutlinger et al., 1980). Xylazine administration results in hypotension and bradycardia in conscious, SHR and urethane-anesthetized rats (Savola, 1986), and in rhesus monkeys (Reutlinger et al., 1980). Arterial pressure in guinea pigs is decreased at relatively low dosage (Flynn et al., 1988). Cardiovascular effects in domestic species include significantly reduced heart rate and a variety of arrhythmias, and effects on cardiac output and blood pressure which vary with species and route of administration (Greene and Thurmon, 1988). Xylazine

does not affect cardiac myocyte K_{ATP} channel activity in a model of ischemic myocardial preconditioning (Zaugg et al., 2002).

Other reported pharmacologic effects of xylazine include the following: decreased rectal temperature in rhesus monkeys (Reutlinger et al., 1980); hyperglycemia due to reduced insulin secretion from pancreatic islets (Hsu and Hummel, 1981); decreased plasma insulin and increased plasma glucagon and blood glucose (Greene and Thurmon, 1988), probably a generalized alpha2 effect on the pancreas (MacDonald and Virtanen, 1992); increased GH and decreased serum antidiuretic hormone (Greene and Thurmon, 1988); increased serum prolactin and altered serum testosterone levels in rats following decapitation (Nazian, 1988); acute reversible corneal desiccation and lens opacity in rats and mice (Calderone et al., 1986); increased uterine pressure in dogs (Wheaton et al., 1989), goats (Perez et al., 1997), horses (Schatzmann et al., 1994), and cattle (Rodriguez-Martinez et al., 1987).

C. Medetomidine

1. Description

Medetomidine is an imidazole derivative more potent than xylazine (Salonen, 1992; Savola et al., 1986), with higher alpha2-adrenoceptor selectivity, greater lipophilicity, and faster elimination (Scheinin and Macdonald, 1989). Medetomidine is an equal mixture of two optical enantiomers, dexmedetomidine and levomedetomidine. The hypnotic/analgesic actions are due to the D-enantiomer dexmedetomidine; levomedetomidine is considered to be pharmacologically inactive (MacDonald and Virtanen, 1992). Dexmedetomidine has recently been approved by the FDA for use in humans (Precedex) and dogs (Dexdomitor; <http://www.fda.gov/cvm/Green_Book/200702.pdf>http://www.fda.gov/cvm/Green_Book/200702.pdf, accessed 24 July 2007). A comprehensive series of articles on the veterinary use of medetomidine and dexmedetomidine have been published (Daunt and Maze, 1992; Lammintausta et al., 1989; Murrell and Hellebrekers, 2005).

2. Biodisposition

Racemic medetomidine is quickly absorbed after IM administration, with peak plasma levels occurring in approximately 30 minutes. Elimination from plasma is rapid, with reported half-lives varying between 0.96 and 1.28 hours (Kuusela et al., 2000; Salonen, 1992). In the rat, absorption of medetomidine following SQ administration is rapid, with peak plasma concentrations reached within 10 minutes. Peak levels in the brain are five times higher than those in the plasma and are reached in 15–20 minutes. Approximately 85% of the drug in plasma is protein-bound. Excretion of ^3H -labeled medetomidine is mainly in the urine: 41% over 72 hours compared with 18% in the feces. Five percent or less of the urine radioactivity

is unchanged medetomidine. Elimination half-life is 1.6 hours (Salonen, 1989).

Medetomidine and detomidine are metabolized similarly, by hepatic monooxygenases. Hydroxylated products may be subsequently oxidized or conjugated with glucuronic acid. The principal metabolite in rats is hydroxydetomidine glucuronide. Simple hepatic hydroxylation can explain the rapid removal of the drug; metabolism is regulated primarily by hepatic blood flow (Salonen, 1992).

3. *Pharmacologic Effects*

In mice, very low doses of medetomidine are anxiolytic without obvious signs of sedation (MacDonald et al., 1989). There is a dose-dependent decrease in spontaneous activity and prolongation of barbiturate sleep time, more than with either detomidine or xylazine (Virtanen, 1986). In rats, there is a dose-dependent sedation and loss of righting reflexes, but deep sedation is not produced in mice or rabbits. Both medetomidine and detomidine can induce loss of the righting reflex in young chicks (MacDonald and Virtanen, 1992). Antinociceptive actions of medetomidine have been demonstrated in a variety of assays and species (Vainio, 1992), including subcutaneous formalin injection in rats (Pertovaara et al., 1990) and the acetic acid-induced writhing test in mice (Virtanen, 1986). Antinociceptive and sedative actions of medetomidine in rabbits, guinea pigs, and hamsters are inconsistent (Vainio, 1992).

D. Detomidine

1. *Description*

Detomidine is an imidazole derivative closely related to medetomidine (Daunt et al., 1993; Salonen, 1986; Salonen, 1992; see series of articles edited by Lindberg, 1986.) The *in vitro* alpha2-adrenoceptor interactions of detomidine are similar to those of medetomidine, although there are differences in potency, both *in vitro* and *in vivo*, which are small relative to xylazine. Detomidine is a sedative and potent analgesic in rats and mice, but does not lead to loss of the righting reflex, even at high doses (Virtanen, 1986).

2. *Biodisposition*

Absorption of detomidine following subcutaneous administration in the rat is rapid, with peak plasma concentrations reached within 10 minutes. Peak levels in the brain are three times higher than those in the plasma. Excretion of ³H-labeled detomidine is mainly in the urine: 62% over 72 hours compared with 22% in the feces. Only a small amount of the urine radioactivity is unchanged detomidine. Because the plasma elimination half-life is 12.7 hours (compared with a much shorter duration of action), redistribution of drug must be relatively important in termination of clinical effect. In the dog,

horse, and calf, approximately 90% of the drug in plasma is protein-bound. Detomidine metabolism is similar to that of medetomidine. In rats, equal amounts of medetomidine glucuronide and medetomidine carboxylic acid are found in urine (Salonen, 1992).

3. *Pharmacologic Effects*

Detomidine prolongs barbiturate sleep time in mice in a dose-dependent manner. Its effect on spontaneous activity of mice is biphasic, with a decrease in activity at lower doses and vice versa; righting reflex is not lost at any dose (Virtanen, 1986). Antinociceptive effects in rodents are similar to those of medetomidine but much greater than the effects of xylazine. Blood pressure and heart rate changes with detomidine are similar to those seen with medetomidine, except that detomidine does not reduce the blood pressure of conscious SHR rats, except at high dosage (Savola, 1986). Low doses of detomidine in rats result in hypothermia which can be blocked by yohimbine. At higher doses, an increased rectal temperature is observed (Virtanen, 1986).

E. Romifidine

Romifidine is an iminoimidazoline alpha2-adrenoceptor agonist closely related to clonidine. It has typical alpha2-agonist effects and is FDA approved for use in horses. When compared in horses given equipotent doses of xylazine or detomidine, less ataxia and less head lowering is observed with similar antinociception (Hall, Clarke, and Trim, 2001).

F. Alpha2-Adrenoceptor Antagonists

Specific alpha2-adrenoceptor antagonists, such as yohimbine, tolazoline, and idazoxan, have historically been used to reverse alpha2-agonist sedation (Thurmon et al., 1992; Sylvina et al., 1990; Heaton and Brauth 1991). Yohimbine is the prototypical alpha2-antagonist. Tolazoline induces potent H2 receptor-mediated effects and has been associated with gastrointestinal bleeding, abdominal pain, nausea, diarrhea, and exacerbation of gastric ulcer (Thurmon et al., 1999). Idazoxan has also been used to characterize imidazoline receptors in synaptic plasma membranes (Dontenwill et al., 1999).

Atipamezole is an imidazole alpha2-adrenoceptor antagonist with higher affinity for alpha2-adrenoceptors and an alpha2/alpha1 selectivity ratio 200–300 times greater than that for yohimbine. Atipamezole is not selective for subtypes of alpha2-adrenoceptors, and unlike other alpha2-adrenoceptor antagonists, has negligible affinity for 5-HT1A and I2 binding sites. Atipamezole rapidly reverses sedation/anesthesia induced by alpha2-adrenoceptor agonists (MacDonald et al., 1989; Pertovaara et al., 2005; Virtanen, 1989). Sedation as well as other behavioral and physiologic effects of alpha2-agonists are readily

reversed, including bradycardia in cynomolgus monkeys (Mann et al., 1991) and rats (MacDonald and Virtanen, 1992), and reduced gastric secretion (Savola et al., 1989). There is both in vivo and in vitro evidence for significant species differences in the action of the alpha2-antagonists (Hsu, 1992). Reduced alpha2-agonist sedation has also been reported using nonspecific CNS stimulants such as 4-aminopyridine, doxapram, or phentolamine (Stenberg, 1989). These agents may also facilitate recovery when xylazine is used in combination with other agents such as ketamine (Greene and Thurmon, 1988).

Pertovaara et al. (2005) recently reviewed the actions and effects of atipamezole. Atipamezole increases sexual activity in rats and monkeys. In animals with sustained nociception, atipamezole increases pain-related responses by blocking the noradrenergic feedback inhibition of pain. In tests assessing cognitive functions, atipamezole at low doses has beneficial effects on alertness, selective attention, planning, learning, and recall in experimental animals, but not necessarily on short-term working memory. At higher doses atipamezole impairs performance in tests of cognitive functions, probably due to noradrenergic overactivity. Recent experimental animal studies suggest that atipamezole likely has beneficial effects in the recovery from brain damage and might potentiate the anti-Parkinsonian effects of dopaminergic drugs.

V. DOPAMINERGIC RECEPTOR ANTAGONISTS

A. Mechanism of Action and General Description

The phenothiazines and butyrophenone tranquilizers are presently included in the dopaminergic antagonist group, a broad class of agents which produce a number of physiologic effects, including mental calming, decreased response to environmental stimuli and muscular relaxation. In general, these agents do not produce sleep, analgesia, or anesthesia, even at increased dosage, and their effects can be reversed with adequate stimulation (Soma, 1983). Previously, these agents were termed neuroleptics, ataractics, or psychotropic agents (Baldessarini and Tarazi, 2006; Booth, 1988b). In human medicine, these agents are used widely in the treatment of various psychiatric disorders, where the distinction between neuroleptic/antipsychotic agents (e.g., phenothiazines and butyrophenones), and antianxiety/sedative agents (e.g., GABA_A agonists) is perhaps more relevant than in animals (Baldessarini, 1990).

Sedation is an unwanted side effect of antipsychotics in humans, but this is precisely why these agents continue to be used extensively in animals. The phenothiazines and butyrophenones produce a state characterized by suppression of spontaneous movements and complex behaviors while spinal reflexes and unconditioned nociceptive-avoidance behaviors remain intact; psychomotor agitation, curiosity, and apparent

aggressiveness are reduced. Sedation typically occurs at low doses; as the dose is increased, the dose-response curve quickly reaches a plateau after which sedation is merely prolonged and incidence of side effects is increased (Tobin and Ballard, 1979). Overdose produces dystonic reactions.

Antagonism of D2 dopamine receptors in the basal ganglia and limbic portions of the forebrain is thought to produce the calming and mood-altering effects. Similarly, the antiemetic action of these agents against opioid-induced vomiting is associated with dopaminergic antagonism within the chemoreceptor trigger zone. Low-potency antipsychotics, such as chlorpromazine, acepromazine, and promethazine, have antagonistic actions at H₁ histamine receptors that further contribute to their sedative effects. Tolerance to sedation typically develops over time, although adverse autonomic and extrapyramidal effects make them unsuitable for long-term use. The mechanism of action of the antipsychotics has been extensively reviewed by Baldessarini and Tarazi (2006).

Phenothiazines and butyrophenones undergo extensive first-pass enteric metabolism. They are highly bound to plasma albumin. Hepatic metabolism is primarily through oxidative hepatic cytochrome P450 isozymes, *N*-demethylation, and subsequent conjugation to glucuronic acid. The hydrophilic metabolites are excreted into urine and to a lesser extent, bile. The elimination half-life is highly variable among species, and pharmacodynamic effects do not correlate with plasma concentration (Marroum et al., 1994). Chlorpromazine stimulates hepatic microsomal enzyme activity in the rat (Aurori and Vesell, 1974).

Hypotension may occur following administration of either phenothiazines or butyrophenones (Booth, 1988b; Hall et al., 2001; Soma, 1983); hypotension associated with general or epidural anesthesia is potentiated, as well (Booth, 1988b). This has been variably attributed to alpha1-adrenergic antagonism, masking of endogenous catecholamine effects on vascular β_2 -receptors, and depression of central pressor reflexes mediated by the hypothalamus and brainstem (Muir and Hubbell, 1985; Stepien et al., 1995). In the dog, acepromazine decreases arterial blood pressure, cardiac output, and left ventricular dP/dt_{max} , but does not affect total systemic vascular resistance. Respiratory rate is decreased but effects on blood gas values are minimal (Stepien et al., 1995). Similar effects are observed with azaperone in swine (Hall et al., 2001). During hypotensive anesthesia, acepromazine preserves renal blood flow and glomerular filtration rate (Bostrom et al., 2003). Ventricular arrhythmias secondary to catecholamines are reduced with both phenothiazines and butyrophenones (Dyson and Pettifer, 1997; Maze et al., 1985).

There is abundant information available on the use of phenothiazines and butyrophenones in the veterinary medical literature, but very little on the pharmacology of these agents in rodents and rabbits. Use of these agents either for calming effect or as preanesthetics has received relatively little attention in

laboratory animal medicine, greatest use has been as an adjunct with other anesthetic agents, especially opioids and ketamine (see Anesthetic Combinations, Section VIII).

B. Phenothiazine Derivatives

The sedative phenothiazines used in veterinary medicine are limited primarily to chlorpromazine (Thorazine), promazine (Sparine), and acepromazine (Booth, 1988b). Acepromazine, the 2-acetyl derivative of promazine, is FDA approved for use in dogs, cats, and horses. Propriopromazine is used in some European countries (Hall et al., 2001). Promethazine is a phenothiazine used chiefly for its antihistaminic properties.

Phenothiazines have a tricyclic structure where two benzene rings are linked by a third central ring containing a sulfur and a nitrogen atom. Unlike promazine, chlorpromazine and acepromazine both have an aliphatic side chain attached to the benzene ring structure at carbon position 2. The addition of the aliphatic side chain confers low potency but pronounced sedative effect. Substitution of piperidine or piperazine side chains at this location changes potential for sedation, autonomic, and extrapyramidal effects (Baldessarini and Tarazi, 2006).

There is little direct evidence that phenothiazines, particularly acepromazine, cause or potentiate seizure activity in animals. Of the common antipsychotic/neuroleptic agents, only high doses of the low-potency aliphatic phenothiazines, particularly chlorpromazine, are linked in humans with reduced seizure threshold and EEG discharge patterns associated with epileptic seizure disorder; the butyrophenones rarely cause seizures (Baldessarini and Tarazi, 2006). As acepromazine is an aliphatic phenothiazine, similar recommendations have been uncritically applied to animals. Although abnormal EEG spiking was observed in some individuals, no seizures were reported in beagle dogs with a familial history of epilepsy when high-dose chlorpromazine was administered together with intermittent light stimulation (Redman et al., 1973). Similarly, no seizures were reported in a retrospective study where acepromazine was administered to seizing dogs or dogs with prior history of seizures (Tobias et al., 2006).

Other reported effects of the phenothiazines vary with drug, dosage, and method of assessment. These include hyperglycemia, reduced hematocrit due to splenic sequestration, gastrointestinal antisecretory activity, and teratogenic effects in mice and rats. These drugs also may be antipyretic, hypometabolic, and antiemetic, and weakly anticholinergic, antihistaminic, and antispasmodic (Booth, 1988b; Niemegeers et al., 1974). Platelet function in the rat is decreased by acepromazine (Dwyer and Meyers, 1986); in dogs, however, the effect is transient and not associated with increased surgical blood loss (Barr et al., 1992). IM chlorpromazine in the rabbit is not recommended due to severe myositis and paralysis (Bree et al., 1971).

C. Butyrophenone Derivatives

The butyrophenone (phenylbutylpiperidine) antipsychotic/neuroleptic tranquilizers are heterocyclic compounds and include droperidol (Inapsine), azaperone (Stresnil), and fluanisone. Although chemically dissimilar to the phenothiazines, the butyrophenones share many functional properties. Their antipsychotic effects are based on antidopaminergic actions in the basal ganglia and limbic portions of the forebrain (Baldessarini and Tarazi, 2006). As with the phenothiazines, no analgesic effects are produced.

1. Droperidol (*Inapsine*)

Droperidol is relatively short-acting compared with other butyrophenones. It is an especially potent antiemetic and antitraumatic shock agent, with potency greater than that of chlorpromazine in its tranquilizing effect and inhibition of learning behavior and amphetamine antagonism in rats (Booth, 1988b). Although the neuroleptic agents have no direct analgesic effects, there remains controversy about the effects of these agents on opioid-mediated antinociception; studies in sheep (Kyles et al., 1993) and mice (Greene, 1972) found that droperidol enhanced the antinociceptive activity of fentanyl. The combination of droperidol with fentanyl (Innovar-Vet) is no longer commercially available (see Anesthetic Combinations, Section VIII).

Droperidol inhibits cardiovascular Na^+ , Ca^{++} , and K^+ channels (Pacher and Kecskemeti, 2004); the FDA recently placed a *black box warning* on human droperidol use regarding the potential for QT prolongation leading to torsades de pointes and sudden death (Kao et al., 2003). Droperidol is effective in reducing epinephrine-induced arrhythmias (Yelnosky et al., 1964), and, like other drugs in this class, increases plasma prolactin (Booth, 1988b).

2. Azaperone (*Stresnil*)

Azaperone has been characterized as a sedative neuroleptic in the rat. Conditioned and exploratory behaviors are inhibited and there is a potent protective effect in traumatic shock (Niemegeers et al., 1974); an analgesic effect is claimed (Olson and Renchko, 1988). Similar sedative and behavioral effects are seen in mice, besides a potent potentiating effect on pentobarbital hypnosis (Niemegeers et al., 1974). Azaperone reverses dominant-subordinate relationships in rats (Desmedt et al., 1975) and mice (Niemegeers et al., 1974), as well as swine (Porter and Slusser, 1985). It is FDA approved in the US and licensed in the EU for use in swine weighing less than 36 kg, to control aggressiveness and fighting when new animals are introduced (Booth, 1988b; Hall et al., 2001).

In the rat, 90% of a radiolabeled azaperone dose is excreted within 48 hours. About 25% of the dose is recovered in the

urine and the remainder in feces; 13% is excreted unchanged. Principal metabolic pathways are oxidative *N*-dearylation and *N*-dealkylation (Heykants et al., 1971).

Azaperone administration to male mice and rats of both sexes results in transient elevation in respiratory rate; in female mice, there is a progressive decline in respiration (Olson and Renchko, 1988). Increased respiratory rate has been reported in swine, horses, and dogs. Azaperone displays a potent alpha-adrenolytic effect on rabbit spleen strips *in vitro*, and a less potent antihistamine effect on guinea pig ileum. In the isolated guinea pig atrium, azaperone does not decrease contractility, but does produce a negative chronotropic effect (Niemegeers et al., 1974). In swine, dose- and route-dependent hypotension is observed (Booth, 1988b).

3. *Fluanisone*

Fluanisone is used most commonly in combination with fentanyl as a neuroleptanalgesic (Flecknell and Mitchell, 1984; Flecknell et al., 1989) (Hypnorm; Anesthetic Combinations, Section VIII).

VI. MISCELLANEOUS AGENTS

A. Urethane

1. *Mechanism of Action*

Relatively little is known about urethane's mechanism of action, although it is apparent that it acts in ways unlike most other anesthetics; effects on GABAergic neurotransmission are unclear (Hara and Harris, 2002). Urethane produces little or no enhancement (Maggi and Meli, 1986a; Shirasaka and Wasterlain, 1995;), or inhibition (Accorsi-Mendonca et al., 2007), of GABAergic neurotransmission in the central and peripheral nervous systems. Sceniak and MacIver (2006) concluded that urethane acts by reducing intrinsic excitability of neuronal membranes, rather than affecting synaptic transmission. However, urethane reverses the antagonistic effect of bicuculline on GABA-induced depolarization in the isolated rat superior cervical ganglion (Bowery and Dray, 1978), and Hara and Harris (2002) found a variety of effects using recombinant neurotransmitter receptors expressed in *Xenopus* oocytes. Urethane, at presumed clinically effective concentrations, enhanced function of $\alpha_1\beta_2\gamma_2\delta$ GABA_A and α_1 glycine receptors (23 and 33%, respectively), inhibited function of NR1a/NR2A NMDA and GluR1/GluR2 AMPA receptors (10 and 18%), and enhanced function of the nACh receptor (15%). These results are unusual, compared with other anesthetic agents, in that (1) most other agents do not have primary effect at more than one receptor type; (2) the magnitude of effect for urethane is less than that reported for other agents; and (3) other agents (e.g., isoflurane, ketamine,

and thiopental) inhibit rather than enhance nACh function. This spectrum of action is similar only to that of ethanol.

2. *Description*

Urethane (ethyl carbamate) is the ethyl ester of carbamic acid. It is readily soluble in water, alcohol and lipids. The frequent and continued use of urethane in neurophysiologic studies derives not only from its relatively minor effects on neurotransmission (Albrecht and Davidowa, 1989), but also from its ability to produce relatively long, stable anesthesia following a single administration (Flecknell, 1996). It is by no means an ideal anesthetic, as indicated by the variety of reported pharmacologic effects (below). Urethane differs from chloralose especially in having analgesic properties sufficient to permit surgery in small rodents (Field and Lang, 1988; Flecknell, 1996; Maggi and Meli, 1986a). In discussing the pharmacologic effects of urethane, Maggi and Meli (1986c) stress the importance of dose and route of administration, and the need to distinguish between normal resting function during anesthesia and the degree of response to physiopharmacologic stimuli.

"Urethane is a potent multisite carcinogen capable of inducing tumors in various organs and animal species regardless of the route of administration" (Ganayem, 2007), and has been classified as "reasonably anticipated to be a human carcinogen" (National Toxicology Program (NTP), 2000). It is also a potent mutagen (Field and Lang, 1988; Ganayem, 2007). Before using urethane, alternative anesthetics should be considered whenever possible. Precautions suitable for handling a moderate carcinogen should be utilized, including the use of appropriate breathing masks, gloves, and fume hoods for preparing solutions from the powdered drug. Given its carcinogenic potential, urethane should not be used for recovery procedures (Flecknell, 1996).

3. *Biodisposition*

Urethane has been administered by most routes, including topical application in frogs (Strobel and Wollman, 1969). Following IV administration, urethane has a wide margin of safety and produces long-lasting narcosis (8–10 hours) with minimal cardiovascular or respiratory depression and maintenance of spinal reflexes (Buelke-Sam et al., 1978). It distributes evenly to most body tissues, except fat (Nomeir et al., 1989).

Until recently, it was widely believed that the principal metabolic path for urethane was esterase-catalyzed hydrolysis to carbon dioxide, ammonia, and ethanol (Nomeir et al., 1989; Skipper et al., 1951). However, recent work has shown that more than 95% of urethane is metabolized via cytochrome P450, specifically CYP2E1, to vinyl carbamate, vinyl carbamate epoxide, and eventually CO₂ and NH₃. Knockout mice (Cyp2e1^{-/-}) given ¹⁴C-labeled urethane have a six-fold decrease in recovered ¹⁴CO₂ compared with wild-type mice, and a marked increase in half-life (22 hours vs. 0.8

hours). Pretreatment of mice with 1-aminobenzotriazole (ABT), a universal P450 inhibitor, results in a similar metabolic pattern in both genotypes. Using a pharmacokinetic model, production of CO₂ from urethane via esterase metabolism is negligible, accounting for less than 0.5% of an administered dose, compared with 96% via CYP2E1 and 3.2% for cytochromes P450 other than CYP2E1. CO₂ is a final end-product of urethane metabolism by each of these pathways, and 91–93% of administered ¹⁴C-urethane is recovered in expired CO₂ within 6 hours (Hoffler et al., 2003). In both rat and mouse given carbonyl-¹⁴C-labeled urethane, there is almost complete recovery of radiolabel in expired CO₂, with small amounts found in feces or urine (Bryan et al., 1949). At low urethane doses, recovery of labeled CO₂ may approach 100% within 12 hours. In vitro metabolism to CO₂ can be demonstrated in a variety of tissues, including liver, plasma, brain, muscle, and kidney (Nomeir et al., 1989).

Because urethane is a known carcinogen, there has been particular interest in its metabolism. Metabolic activation of the ethyl moiety is required for carcinogenic action, but the metabolic pathways leading to activation or detoxication remain incompletely characterized (Kurata et al., 1991). Neoplastic lesions are significantly reduced following 6-week urethane dosing in Cyp2e1^{-/-} mice, indicating a central role of the CYP2E1 pathway, presumably via formation of vinyl carbamate epoxide (Ganayem, 2007).

4. Pharmacologic Effects

As with other anesthetics, there are strain and sex differences in the dose of urethane needed to induce surgical levels of anesthesia. The threshold blood urethane concentration for narcosis in rats was determined by Boyland and Rhoden (1949) by injecting rats SQ with 1.0 g/kg urethane and measuring blood levels of urethane at various times. Rats with blood concentrations below 60 mg/100 ml are not anesthetized, while those with concentrations of at least 80 mg/100 ml (10 mM) are anesthetized for 8–12 hours. A SQ dose of 1.6 g/kg urethane is required to surgically anesthetize male Sprague-Dawley rats (Braun et al., 1997), while female WU (WI) rats require a SQ urethane dose of 1.8 g/kg (Van Der Meer et al., 1975). In male Wistar Morini rats, 1.0 g/kg urethane SQ produces surgical levels of anesthesia in only 30% of the rats after 3 hours and 90% after 6 hours. In contrast, a dose of 1.2 g/kg SQ resulted in surgical anesthesia in 100% of the same rats after 3 hours, with anesthetic effect lasting at least 6 hours (Maggi and Meli, 1986a).

The necessary IP urethane dose ranges from 0.8 to 1.2 g/kg. In male Wistar rats, a surgical level of anesthesia is achieved with 0.8 g/kg urethane IP (Pettinger et al., 1975). In female CD (Sprague-Dawley) rats, a surgical level of anesthesia is achieved with 0.8–1.0 g/kg urethane IP, although 1.2 g/kg is required to ensure anesthesia of all animals (Hamstra et al., 1984). Lincoln et al. (1973) reported that 1.1 g/kg IP provided anesthesia levels suitable for stereotaxic manipulation and neurosurgery for at least 8 hours in female Wistar rats. Female WU (WI) rats require an

IP dose of 1.0 g/kg to reach a surgical level of anesthesia (Van Der Meer et al., 1975).

a. Nervous System Effects

Urethane has slight depressant effects on autonomic reflexes and the activity of subcortical structures of the CNS. Basal activity of nigrostriatal dopamine-containing neurons in the rat is reduced as compared with unanesthetized paralyzed controls (Kelland et al., 1990). There is, in general, an activated sympathetic outflow from the CNS to peripheral organs (Maggi and Meli, 1986a). Cardiovascular stability with urethane is due in part to sustained sympathetic nervous system activity and is associated with high circulating catecholamine levels (Carruba et al., 1987). Urethane attenuates expression of kindled seizures in rats, where brief, low-intensity, electrical stimulation is periodically applied to the amygdala, and may not be an appropriate anesthetic for the study of epileptiform phenomena (Cain et al., 1989). Steward et al. (2005) reviewed the effect of several anesthetics, including urethane, on neurotransmitter systems in the context of the rat brain blood oxygen level-dependent (BOLD) contrast pharmacological MRI.

b. Route of Administration and Cardiovascular Effects

Blood pressure effects of urethane are dependent on the route of administration. IP injection of 1.2 g/kg in female Wistar rats decreases mean blood pressure to 95 mmHg, compared to 125 mmHg in unanesthetized animals, which persisted for at least 1 hour after injection (Hillebrand et al., 1971); in some individual animals, pressure dropped below 80 mmHg. In contrast, IP injection of 1.2 g/kg urethane to male Wistar and Sprague-Dawley rats caused no change in mean arterial blood pressure and heart rate (Carruba et al., 1987). The fall in blood pressure after IP injection of 25% urethane at 1 g/kg can reportedly be reduced by slow injection, and is absent if the dose is given rapidly intraarterially (Van Der Meer et al., 1975).

When urethane was injected IV to male Wistar rats at a dose of 1.3 g/kg, blood pressure transiently dropped, but recovered to near baseline by 5 minutes after the infusion (Volicer and Loew, 1971); this was accompanied by a transient rise in heart rate, which also recovered. IV injection of 0.2–0.8 g/kg urethane also resulted in a 5–10 minute drop in arterial pressure, followed by a progressive increase in pressure (Reinert, 1964).

Arterial pressure, cardiac output, and renal, hepatosplanchnic, and brain blood flows in rats were lowest with IP urethane anesthesia compared with four other anesthetic regimens, and lower than published values for the conscious rat (Gumbleton, 1989, 1990a). Similar depressant effects on cardiac dynamics of the rat have been reported (Maggi et al., 1984; Wang et al., 1991), although others have found cardiorespiratory effects to be minimal (De Wildt et al., 1983; Folle and Levesque, 1976), especially when the IP route of administration is avoided and doses are kept to the minimum required (Maggi and Meli,

1986b). Heart rate and systolic pressure in rats are stable during prolonged (3 hour) anesthesia, although pulse pressure is consistently elevated (due to decreased diastolic pressures) (Buelke-Sam et al., 1978). The baroreceptor reflex in rats is altered (Fluckiger et al., 1985; Wang et al., 1991). In a cellular model of simulated myocardia ischemia, diazoxide-induced cell protection of mitochondrial KATP channel activity was potentiated by urethane anesthesia (Zaugg et al., 2002).

c. Effect on Ventilation

Respiratory effects of urethane anesthesia are minimal (Maggi and Meli, 1986c), although changes in blood gas values have been reported in the rabbit (Collado et al., 1987) and rat (Buelke-Sam et al., 1978; Folle and Levesque, 1976). Significant hypercapnia and hypoxia occur in the hamster (Reid et al., 1989). In contrast, Field et al. (1993) found that rats anesthetized with urethane had a severely depressed arterial pH, with an increased PaO₂ and decreased PaCO₂ suggestive of hyperventilation.

In decerebrate male Wistar rats, 750 mg/kg IV urethane has no effect on respiratory frequency or tidal volume, although blood pressure and heart rate decrease (Sapru and Krieger, 1979). In male Sprague-Dawley and Wistar rats, 1.2 g/kg urethane IP has minimal effects on blood gas parameters until 4 hours after anesthesia (Carruba et al., 1987). There is a tendency for pH to decrease and arterial PO₂ and PCO₂ to rise during the anesthesia. After 3–4 hours under anesthesia, PCO₂ rises significantly from a baseline value of 40–49 mmHg, and PO₂ increases from 80 to 105 mmHg.

In Sprague-Dawley rats, where 1.2 and 1.5 g/kg IP provided sleep time in excess of 24 hours, anesthesia was characterized by progressive acidosis, hypocapnea, hyperoxia, hypotension, and bradycardia (Field et al., 1993). In another study, male Sprague-Dawley rats were injected with 1.5 g/kg urethane IP and blood gas parameters were measured under normothermic and hypothermic conditions (Alfaro and Palacios, 1992). If the rats were maintained at normal body temperature, changes in blood values were minimal. Arterial PO₂ and PCO₂ remained unchanged, while arterial pH dropped from 7.48 to 7.42. Bicarbonate levels decreased from 21.8 to 18.9 mmol/L, and arterial lactate increased from 0.89 to 2.78 mmol/L. If the rats were not warmed, body temperature dropped from 37 to 30°C by 2 hours. The hypothermic rats showed a progressive increase in PaO₂ over time, with an increase of 20–30 mmHg after 2 hours. The changes in arterial bicarbonate, lactate, and pH in the hypothermic group were similar to those seen in the normothermic animals. It is suggested that the increase in arterial PO₂ seen in an earlier study (Carruba et al., 1987) might have been caused by hypothermia.

d. Effect on Hematocrit and Blood Glucose Levels

Urethane is known to affect hematocrit in rats. Rats injected with 1.5 g/kg urethane using a 50 wt% urethane solution show

“marked hemoconcentration” after 8 hours (Spriggs and Stockham, 1964). In a study investigating the effect of administration route on urethane-induced hemoconcentration, urethane was administered at doses sufficient to induce stage 4–5 anesthesia via four different routes: IP, SQ, PO, and IA. After 60 minutes the hematocrit in the rats changed by the following respective amounts: +21.7%, +8.0%, –2.8%, and +1.5%. The large increase in hematocrit following IP injection was attributed to plasma loss to the peritoneal cavity. An approximately linear relationship between dose of IP-injected urethane and relative increase in hematocrit was also found, with a slope of 2.1% increase in hematocrit for every 0.1 g/kg increase in urethane dose (Van Der Meer et al., 1975). Severs et al. (1981) showed that IP urethane causes peritoneal fluid accumulation, hyperosmolality of body fluids, osmotic toxicity to the mesenteric vasculature, and increased plasma renin activity and aldosterone levels.

Urethane also has a profound effect on blood glucose levels. Blood glucose level of fasting rats increases from 58 to 168 mg/dl 1 hour after IP injection of urethane at a dose of 1.25 g/kg (Reinert, 1964); similar findings were reported by Van Der Meer et al. (1975) and Braun et al. (1997). Van Der Meer et al. (1975) speculated that urethane induced hyperglycemia through “stimuli arising in the damaged tissues” at the injection site, although increased peripheral sympathetic activity and increased circulating catecholamine levels is a more plausible explanation (Carruba et al., 1987; Pettinger et al., 1975; Spriggs and Stockham, 1964). Elevated blood glucose also occurs in the rabbit (Collado et al., 1987) and rat, due at least in part to elevated catecholamine levels (Hinton, 1982; Maggi and Meli, 1986a).

e. Immune System Effects

Urethane is immunosuppressive and has demonstrated anti-neoplastic effect. It is, however, more commonly recognized for its carcinogenic and mutagenic properties (Field and Lang, 1988; Iversen, 1991; Inai et al., 1991; Leithauser et al., 1990; Sotomayor and Collins, 1990).

In adult male HsdBrl:WH Wistar rats, urethane reduces splenic IL-1beta mRNA expression while ketamine/xylazine, chloral hydrate, and pentobarbital all enhance the basal expression of IL-1beta and IL-6 mRNA. Urethane, ketamine/xylazine, and TBE reduce basal TNFalpha mRNA levels, whereas TNFalpha mRNA expression is unaffected by chloral hydrate and pentobarbital (Bette et al., 2004).

f. Pathologic Effects

Pathologic effects following IP administration of urethane have been reported in the rat (Gumbleton et al., 1988; Severs et al., 1981; Van der Meer et al., 1975). A toxic effect on the mesenteric vasculature results in peritoneal effusion and secondary impairment of renal function. The resulting hypovolemia

may explain observed increases in serum renin (Severs et al., 1981). Hypertonic urethane administration in the rabbit, by either IV or IP routes, causes hemolysis, increased serum potassium, and prolonged clotting time (Bree and Cohen, 1965).

Other reported pharmacologic effects of urethane include the following: depressed xenobiotic renal clearance in the rat (Gumbleton et al., 1990b); depressed antipyrine clearance, an indicator of intrinsic hepatic clearance, in the rat (Gumbleton and Benet, 1991); blunted plasma GH response to GH-releasing hormone, due in part to enhanced somatostatin release from the hypothalamus (Hosoi et al., 1988); lowered basal gastric acid secretion, due in part to increased synthesis and release of endogenous (gastric) somatostatin (Yang et al., 1990); and rise in plasma beta endorphin activity (Ramirez-Gonzalez et al., 1991).

B. Eugenol

1. Mechanism of Action

The chemical structure of eugenol is similar to that of capsaicin. Like capsaicin, the mechanism of action is thought to be through vanilloid receptor 1 (VR1) antagonism; however, affinity toward the GABA_A and the NMDA glutamate receptor has also been demonstrated.

An important consideration is possible species and dose-response differences in eugenol derivative inhibition of nociception (analgesic or anesthetic effect) and the specific blockade of nicotinic receptors (paralytic effect). Guenette et al. (2006) demonstrated dose-dependent reduction of pedal withdrawal reflex of 167 seconds following administration of 60 mg/kg eugenol IV to isoflurane-anesthetized male Sprague-Dawley rats. Eugenol and isoeugenol, however, have nondepolarizing neuromuscular blocking effects (Brodin and Roed, 1984; Ingvast-Larsson et al., 2003); reduced pedal withdrawal reflex observed with eugenols may, therefore, not be entirely due to antinociception (Meyer, 2007). Neuromuscular blockade has not been explicitly demonstrated in fish with topical exposure to eugenol derivatives; however, mechanisms of neuromuscular transmission are similar for all vertebrates (Ingvast-Larsson et al., 2003). Eugenol derivatives should be used cautiously as general anesthetics in any species until it can be determined that exposure results in sedation or unconsciousness rather than paralysis.

2. Description

Eugenol [2-methoxy-4-(2-propenyl) phenol], the principal constituent of clove oil (a mixture of 85–95% eugenol and 5–15% isoeugenol and methyleugenol), is derived from the clove tree *Eugenia aromatica* and the nutmeg *Myristica fragrans*. Eugenol, isoeugenol, guaiacol, and vanillin are all derivatives of hydroxymethoxybenzene, and each can cause

neurologic depression and coma when used in high concentrations in rats (Taylor et al., 1964). The local analgesic effects of eugenol are well accepted in human dentistry. Isoeugenol has been used as a fish anesthetic in New Zealand, to aid fish harvesting in Australia, and fish vaccination in Norway (Keene et al., 1998; Sladky et al., 2001; Soto and Burhanuddin, 1995).

The National Toxicology Program (NTP), Department of Health and Human Services, conducts studies on nominated drugs and chemicals to determine their potential to cause cancer. The NTP has assessed that eugenol is an equivocal carcinogen and methyleugenol is carcinogenic to rodents. Despite *in vivo* studies conducted on isoeugenol, the NTP has not yet reached a conclusion regarding its carcinogenicity. The status of toxicology studies conducted on these compounds can be found on the NTP website (<http://ntp-server.niehs.nih.gov/>, accessed 20 June 2007). Currently, neither clove oil nor any of its components are the subject of an approved new animal drug application and, because of safety concerns, should not be used as an anesthetic in fish in the United States (<http://www.fda.gov/cvm/Guidance/guide150.pdf>, accessed 20 June 2007).

3. Biodistribution

The pharmacokinetics of eugenol and isoeugenol have been described (Badger et al., 2002; Guenette et al., 2006). Eugenol administered IV to male Sprague-Dawley rats produces dose-dependent reduction of pedal withdrawal reflex lasting 167 seconds at the highest dose tested (60 mg/kg) (Guenette et al., 2006). Mean systemic clearance in plasma and blood were 157 and 204 ml/min/kg, respectively, and glucuronide and sulfate conjugates were identified in urine. Isoeugenol is rapidly metabolized and excreted predominantly in the urine as phase II conjugates of the parent compound. Following a single oral dose of [¹⁴C]isoeugenol (156 mg/kg, 50 microCi/kg) to male Fischer 344 rats, greater than 85% of the administered dose is excreted in the urine, predominantly as sulfate or glucuronide metabolites, by 72 hours (Badger et al., 2002). Approximately 10% is recovered in the feces, and less than 0.1% is recovered as CO₂ or expired organics. Following IV administration (15.6 mg/kg, 100 microCi/kg), isoeugenol disappears rapidly from the blood. The plasma half-life is 12 minutes and the systemic clearance is 1.9 l/min/kg. Excretion characteristics of IV isoeugenol were similar to those following oral administration.

4. Pharmacologic Effects

Eugenol derivatives have been used IV to induce general anesthesia in humans (Dundee and Clarke, 1964), and isoeugenol is reported to induce general anesthetic properties in mice (Sell and Carlini, 1976) and rats (Guenette et al., 2006). Compared with tricaine methanesulfonate (MS-222), eugenol anesthesia in red pacu fish (*Piaractus brachypomus*) was associated with more rapid onset and more prolonged recovery times

(Sladky et al., 2001). Both tricaine methanesulfonate and eugenol immersion produce hypoxemia, hypercapnea, respiratory acidosis, and hyperglycemia. However, eugenol-anesthetized pacu fish require more resuscitation for ventilatory failure, and are more likely to react to a hypodermic needle puncture, implying a narrow margin of safety and questionable analgesia (Sladky et al., 2001). In leopard frogs, eugenol immersion at 310–318 mg/L for 15 minutes results in anesthesia lasting up to 65 minutes, while immersion in a similar concentration of propofol failed to induce anesthesia (Lafortune et al., 2001). In the African clawed frog (*X. laevis*), eugenol immersion at 350 mg/L results in surgical anesthesia lasting at least 30 minutes (Guenette et al., 2007).

VII. LOCAL ANESTHETICS

A. Mechanism of Action

Local anesthetics block nerve conduction by decreasing or preventing the large transient increase in permeability to Na^+ that is normally produced by depolarization of excitable membranes. Studies in adult male Sprague-Dawley rats indicate that neural evoked action potential must be reduced at least 50% before a measurable loss of peripheral nerve function occurs (Popitz-Berger et al., 1995). Molecular mechanisms of local anesthesia have been extensively reviewed (Butterworth and Strichartz, 1990; Catterall and Mackie, 2006; Liu and Joseph, 2006).

Local anesthetics are weak bases with pK_a values somewhat above physiologic pH; local anesthetics thus exist in both charged (RNH^+) and uncharged (RN) forms, the proportion of which varies with drug pK_a and local tissue pH. As a result, <50% of a local anesthetic exists in a lipid-soluble nonionized form (RN) at pH 7.4.



The nonionized active base (RN) formed from the dissociation of the HCl salt in normally slightly alkaline tissue diffuses most easily across lipid barriers. The cation (RNH^+) is subsequently reformed and interacts with the interior of the Na^+ channel from the intracellular side.

The voltage-gated Na^+ channel is a specific receptor for local anesthetics. Binding affinities of local anesthetics to the Na^+ channel are stereospecific and depend on the conformational state (Lee-Son et al., 1992). In the resting nerve membrane, Na^+ channels are distributed in equilibrium between the rested-closed and inactivated-closed states. The cationic RNH^+ form gains binding site access from the intracellular side only when the Na^+ channel is in the activated-open state. By selectively binding to Na^+ channels in inactivated-closed

states, local anesthetics stabilize these channels and prevent their change to the rested-closed and activated-open states in response to nerve impulses; subsequent propagated action potentials can not occur. Repeated stimulation (frequency-dependent block) increases the probability that Na^+ channels will exist in the open-inactive form; a stimulated nerve thus becomes more sensitive to local anesthetic block than a resting nerve. Frequency-dependent block also plays an important role in the cardiac antiarrhythmic activity of local anesthetics.

The potency of a local anesthetic is determined mainly by lipid solubility, the time of onset by the pK_a , and the duration of action by protein binding. Increasing lipid solubility enhances drug partitioning to sites of action and reduces metabolism; both Na^+ channel receptor affinity and toxicity are increased. Although higher lipid solubility enhances neural membrane penetration, onset of blockade is delayed due to sequestration in myelin and other lipid-soluble compartments; similarly, sequestration in myelin slows recovery and prolongs effect by acting as a slow release substrate. Decreasing pK_a , for a given tissue pH, will increase the amount of the lipid-soluble active base and speed neural membrane penetration and onset of action. The pK_a for commonly used local anesthetics ranges from 7.6 (mepivacaine—61% ionized at pH 7.4) to 8.9 (procaine—97% ionized at pH 7.4) (Liu and Joseph, 2006). Protein binding affects activity, as only the unbound, nonionized active base crosses the lipid membranes; in general, the more lipid-soluble and longer-lasting agents increase protein binding.

In addition to Na^+ channels, local anesthetics can interact with K^+ and L-type voltage-dependent Ca^{++} ion channels (Sugiyama and Mutecki, 1994). It is important to note that multiple types of Na^+ channels exist (e.g., Na^+ channels in the brain, axons, and heart are not identical), and a variety of Na^+ channels may be present in tissues, such that some local anesthetic effects (e.g., CNS toxicity) may be mediated by actions other than interference with Na^+ channel function.

Neuraxial administration of local anesthetics may produce spinal dorsal horn antinociception through mechanisms other than Na^+ blockade (Liu and Joseph, 2006). Tachykinins (substance P) are neurotransmitters which modulate antinociception from C fibers; epidural or spinal-administered local anesthetics at clinically relevant concentrations inhibit postsynaptic depolarizations caused by substance P. Other neurotransmitters present in the dorsal horn, such as acetylcholine, GABA, and NMDA, can all be affected pre or postsynaptically by local anesthetics.

Tachyphylaxis occurs when blockade effectiveness decreases following repeated neuraxial or peripheral nerve blocks, and is not limited to any particular agent. Dosing interval appears to play a key role; if dosing intervals are short enough that pain does not occur, tachyphylaxis does not develop. Interestingly,

pretreatment with NMDA agonists or nitric oxide synthetase inhibitors prevents tachyphylaxis in rats (Lee et al., 1994; Wilder et al., 1996).

B. Description

A variety of chemical types ranging from alcohols, to cocaine, to complex toxins such as tetrodotoxin may have local anesthetic effect (Åkerman, 1988; Lee-Son et al., 1992). The effects of clinically relevant concentrations are reversible, with complete recovery of the nerve function and no evidence of damage to the nerve fibers or the cells in most applications. Clinical use does not require absolute suppression of nerve transmission; disruption of information coding in the form of nerve discharges may be sufficient to produce effective analgesia (Liu and Joseph, 2006). Numerous techniques have been described (Booth, 1988c; Gaynor and Mama, 2002; Skarda, 1996). The adjunctive use of local anesthetics has been proposed to reduce the side effects of general anesthetics (Raman et al., 1989).

Routes of administration include: topical application to the mucous membranes (nose, mouth, throat, tracheobronchial tree, esophagus, genitourinary tract), infiltration directly into tissues without taking into consideration the course of cutaneous nerves (infiltration block), infiltration directly into tissues considering the course of cutaneous nerves to produce anesthesia distally (field block), injection in the direct vicinity of individual peripheral nerves or nerve plexuses (conduction block), and IV regional anesthesia (Bier block). Neuraxial anesthesia includes both epidural and intrathecal (spinal) drug administration. The spinal nerve roots are the primary site of action for local anesthetics; however, the spinal cord and paravertebral nerves may also be affected. These agents also have been used for immersion anesthesia of fish and amphibians, ocular topical anesthesia, and skin topical anesthesia (more below).

Agents that interact with spinal cord opioid (e.g., morphine), phencyclidine (e.g., ketamine), or alpha₂-adrenergic receptors (e.g., xylazine) have also been administered, separately or together with local anesthetics, through the neuraxial route (Gaynor and Mama, 2002; Klide, 1992; Schug et al., 2006; Skarda, 1996; Takano and Yaksh, 1992). As with local anesthetics, neuraxial analgesia with these agents is generally confined to sensory nerves that enter the spinal cord dorsal horn in the region of the injection. Unlike local anesthetics, conduction in autonomic, sensory, and motor nerves is not affected, such that blood pressure, motor function, and non-nociceptive sensory perception typically are not affected. It must be noted that neuraxially administered opioids, phencyclidines, or alpha₂-adrenergic agonists do not by themselves provide satisfactory anesthesia for surgical procedures. On the other hand, neuraxial analgesia with opioids, phencyclidines, or alpha₂-adrenergic agonists generally requires much less agent than necessary to produce similar analgesia through systemic administration.

Coadministration with local anesthetics results in synergistic analgesia (Grubb et al., 1992; Kona-Boun et al., 2006).

C. Biodistribution

All currently available local anesthetics are racemic mixtures, with the exception of lidocaine (achiral), levo-bupivacaine ($L = S$), and ropivacaine (S). S -isomers appear to have nearly equal clinical efficacy, but less potential for systemic toxicity. The comparative pharmacokinetics of local anesthetics in several laboratory and domestic species have been reviewed by Craigmill et al. (1994). The biodisposition of the various local anesthetics and the pharmacologic and toxic effects in humans and domestic animals have been discussed (Booth, 1988c; Catterall and Mackie, 2006; Hall and Clarke, 1991b; Liu and Joseph, 2006; Ritchie and Greene, 1990).

Most clinically useful local anesthetics possess an aromatic lipophilic end, an intermediate ester or amide linkage, and a hydrophilic amine group. The hydrophilic group is usually a tertiary or quaternary amine; the hydrophobic moiety must be aromatic and is usually a substituted benzene ring. Thus, local anesthetics can be either aminoesters or aminoamides.

The aminoesters (e.g., tetracaine, procaine, chlorprocaine, benzocaine) are readily hydrolyzed by plasma esterases within the liver to produce the weakly active diethylaminoethanol and para-aminobenzoic acid; the action of sulfonamides is subsequently inhibited. Following hydrolysis, these products are renally excreted; excretion can be enhanced by lowering urine pH. Specificity of plasma esterases to hydrolyze local anesthetics varies considerably among species; plasma procaine esterase in the dog is negligible compared to humans or the horse (Craigmill et al., 1994).

The aminoamides (e.g., lidocaine, bupivacaine, mepivacaine, prilocaine) are metabolized by hepatic cytochrome P450s with the initial reaction involving N -dealkylation and subsequent hydrolysis. Lidocaine is dealkylated to monoethylglycine xylidide and glycine xylidide, both of which retain anesthetic activity; they are subsequently hydrolyzed or conjugated to sulfate prior to urinary excretion. With prilocaine, a component of EMLA cream (eutectic mixture of local anesthetics), the initial hydrolysis forms *o*-toluidine metabolites which increase the risk of methemoglobinemia. Aminoamides are extensively (55–95%) bound to plasma proteins, chiefly alpha₁-acid glycoprotein. Concurrent disease and/or drug therapy can influence alpha₁-acid glycoprotein levels, thereby changing the amount of aminoamide delivered to the liver for metabolism and influencing systemic toxicity. Reduced cardiac output, as occurs during general anesthesia, also prolongs plasma half-life of aminoamide local anesthetics by reducing hepatic delivery (Catterall and Mackie, 2006; Liu and Joseph, 2006).

The efficacy of local anesthetics may be increased by the addition of epinephrine. Reported benefits include prolongation,

increased block intensity, and decreased systemic absorption following local and neuraxial local anesthetic administration. Epinephrine antagonizes the inherent vasodilating effect of local anesthetics and decreases systemic absorption and intraneural clearance. The smallest possible dose should be used to reduce toxic effects on the tissues, the cardiovascular system, and the peripheral and spinal nerves (generally $\leq 1:200,000$) (Liu and Joseph, 2006).

The pH of commercially available local anesthetics ranges from 3.9 to 6.5; the addition of epinephrine to commercial solutions further reduces pH. The addition of sodium bicarbonate has been proposed to raise the pH closer to the pK_a in order to increase the amount of uncharged lipid-soluble active base of local anesthetic. However, clinically used local anesthetics cannot be alkalized beyond a pH of 6.05–8 before precipitation occurs; the increase in active base in this pH range will only be about 10% (Ikuta et al., 1989). In rats, addition of sodium bicarbonate to 1% commercial lidocaine without epinephrine decreased the degree and duration of block, but addition of sodium bicarbonate to solutions with epinephrine hastened onset of blockade without affecting the degree or duration (Sinnott et al., 2000). In horses, carbonated 2% lidocaine produced no differences in onset time, duration, or sensory blockade for caudal epidural block over 2% lidocaine (Schelling and Klein, 1985). In a double-blind study in human volunteers, pain scores were lower with buffered lidocaine–epinephrine, but not statistically different from lidocaine with freshly added epinephrine (Burns et al., 2006).

D. Pharmacologic Effects

In general, increasing nerve diameter and myelination leads to increased conduction velocity and reduced sensitivity to local anesthetics. Autonomic fibers (preganglionic sympathetic nervous system B fibers), small unmyelinated C fibers (pain sensation), and small myelinated A δ (pain and temperature) fibers are blocked with local anesthetics before the larger myelinated A γ , A β , and A α fibers (posture, touch, pressure, and motor information). Although fiber size per se does not seem to determine sensitivity to local anesthetic block, smaller nerves do have more closely spaced nodes of Ranvier. Because a fixed number of nodes must be blocked to prevent impulse conduction (critical length), small fibers with closely spaced nodes may be blocked more rapidly than larger fibers (differential sensory blockade).

The relative *in vitro* potencies for local anesthetics vary depending on nerve fiber type, frequency of stimulation, and increasing lipid solubility. However, *in vitro* studies on isolated nerves can be poor guides to *in vivo* efficacy. Comparing onset of action and suppression of evoked action potential *in vitro*, mepivacaine was less effective than lidocaine or prilocaine. On the other hand, mepivacaine was more potent, with a longer duration of action and comparable onset time, in parallel studies on the sciatic nerve of live animals (Pateromichelakis and

Prokopiou, 1988). Differential ionization was identified as the cause of reduced mepivacaine performance *in vitro*.

Decreased systemic absorption of local anesthetics results in greater clinical safety. In general, higher doses will result in higher systemic absorption and peak blood levels; highly vascular areas will have faster uptake than areas with more fat. Use of more potent agents with greater lipid solubility and protein binding will result in lower systemic absorption. Addition of vasoconstrictors will be most effective at reducing C_{max} for less lipid-soluble, less potent local anesthetics (Stoelting and Hillier, 2006).

Generalized CNS toxicity may occur from systemic absorption or direct vascular injection. Local anesthetics readily cross the blood–brain barrier. Low doses produce CNS depression, while higher doses result in CNS excitation and seizures. Cortical inhibitory neurons may be more sensitive to impulse blocking effects. In general, CNS toxicity increases with the same factors which increase local anesthetic potency; decreases in protein binding and drug clearance increase CNS toxicity, as well. Addition of epinephrine is advocated to increase the clinical safety margin of local anesthetics by reducing systemic absorption and peak blood levels. However, the convulsive threshold for IV lidocaine in Wistar rats is reduced 42% when epinephrine, norepinephrine, or phenylephrine is added; acute hypertension secondary to vasoconstriction may be responsible (Yokoyama et al., 1995).

In general, much greater doses of local anesthetics are necessary to produce acute cardiovascular toxicity than CNS toxicity. The dose of lidocaine, etidocaine, tetracaine, and bupivacaine required to produce irreversible cardiovascular depression in dogs is 3.5–6.7 times greater than that necessary to produce convulsions (Liu et al., 1983). Like CNS toxicity, cardiovascular toxicity is a function of the potency of the local anesthetic, with bupivacaine being the most cardiotoxic; the amino ethylamide ropivacaine was developed as a less cardiotoxic alternative to bupivacaine (Catterall and Mackie, 2006).

IV lidocaine infusion is preferred in the horse as a prokinetic agent to enhance gastrointestinal motility by reducing postoperative intestinal ileus (Brianceau et al., 2002; Dart and Hodgson, 1998; Malone et al., 2006). The most likely mechanism is reduction of excessive sympathetic nervous system activity. Local anesthetics suppress contractions in the intact bowel and isolated intestine. Neuraxial local anesthesia and instillation of local anesthetics into the peritoneal cavity produce similar reduction of sympathetic nervous system activity and improved gastrointestinal tone (Catterall and Mackie, 2006).

Methemoglobinemia following topical use of benzocaine has been well described (Davis et al., 1993; Severinghaus et al., 1991); it has also been associated with prilocaine, procaine, and lidocaine. The development of methemoglobinemia is dependent on the dose, and is more common in neonates due to decreased resistance of fetal hemoglobin to oxidative stress and immature erythrocyte methemoglobin reductase activity (Stoelting and Hillier, 2006).

Local anesthetic immersion is used for fish anesthesia. Tricaine methanesulfonate (MS-222; tricaine; metacaine; ethyl *m*-aminobenzoate; 3-aminobenzoic acid ethyl ester; used as the methanesulfonate salt) is a soluble local anesthetic agent chemically related to procaine, used for sedation, immobilization, and anesthesia of fish and amphibians; it is the only FDA-approved anesthetic for use in food fish. It can be delivered via the ambient water or in the respiratory stream, and produces both central effects, following absorption, and a local anesthetic effect. Because MS-222 is an acid, the chemical should be buffered (2 parts sodium bicarbonate by weight to 1 part MS-222). Sedation can generally be achieved with concentrations between 50 and 100 mg/L, although species-specific sensitivities should be expected. Onset and recovery are generally rapid, although recovery time increases with increasing concentrations of the agent or prolonged exposure (Lemm, 1993; Spath and Schweickert, 1977). MS-222 produces hypoxemia, hypercapnea, respiratory acidosis, and hyperglycemia in red pacu fish (*P. brachypomus*) (Sladky et al., 2001). Benzocaine immersion is also used as a fish anesthetic, although toxicity may occur when used for cardiac function studies. In rainbow trout (*O. mykiss*), heart rate variability was four times higher under benzocaine (108 ppm) than under clove oil (25 ppm) or MS-222 (60 ppm); benzocaine also produced longer QRS complexes (Cotter and Rodnick, 2006).

Although local anesthetics are usually not effective when topically applied to unbroken skin, a number of methods are being developed to produce cutaneous analgesia without injection. The efficacy of transdermal delivery is dependent on the barrier properties of the skin of the targeted species, as well as the ratio of the area of the transdermal patch to the species total body mass needed to achieve effective systemic drug concentrations. The primary challenge lies in the wide species differences in skin structure and function. Drug must have sufficient lipid solubility to traverse the epidermal barrier to be considered for delivery for this route (Riviere and Papich, 2001).

Eutectic mixture of local anesthetics (EMLA) is a topically applied emulsion containing 25 mg lidocaine and 25 mg prilocaine per gram; occlusive contact with skin for 30–60 minutes is required for effective use. The use of EMLA cream in veterinary medicine has been reviewed by Erkert and MacAllister (2005). Flecknell et al. (1990) have suggested that the use of topical agents to reduce the discomfort of venipuncture may be a useful refinement, especially with inexperienced staff. In placement of jugular catheters in cats, pretreatment with EMLA resulted in less struggling, but the difference between treated and untreated cats did not reach statistical significance (Wagner et al., 2006). Liposome-encapsulated lidocaine and 5% lidocaine transdermal patches have been similarly used in animals (Fransson et al., 2002; Weiland et al., 2006). A systematic review of topical anesthesia for dermal instrumentation in humans concluded that tetracaine, liposome-encapsulated tetracaine, and liposome-encapsulated lidocaine were all at least as effective as EMLA cream (Eidelman et al., 2005).

One hour periorbital exposure to EMLA cream produced no adverse effects on the external lid or anterior segment of rabbit eyes (Cohen et al., 1996). Rat, but not guinea pig, tympanic membranes when exposed to EMLA showed minor changes in thickness, submucosal edema, and epithelial reactions, compared with lidocaine, phenol, and Bonain's solution (Schmidt et al., 1988).

E. Tissue and Histopathology Effects

Local anesthetics can cause local tissue injury (Hall and Clarke, 1991b). All local anesthetic agents are myotoxic, with procaine producing the least and bupivacaine the most severe muscle injury. Histopathologically, diffuse myonecrosis is observed, which is both reversible and clinically imperceptible; regeneration occurs within 3–4 weeks (Zink and Graf, 2004).

Although all clinically used local anesthetics can cause nerve fiber damage at high concentrations, use at clinical concentrations is considered safe for peripheral nerves. The spinal cord and nerve roots, however, may be more susceptible to damage. Histopathologic and neurologic deficits and increased levels of the excitatory neurotransmitter glutamate were reported in rabbits following intrathecal 2% bupivacaine, 8% lidocaine, and 1% tetracaine (Yamashita et al., 2003). It must be noted these concentrations are much higher than those typically used in the clinical setting. Long-term neurologic injury incidence rate was reported to be 0–0.02% in a prospective survey of over 80,000 humans undergoing spinal anesthesia, implying safe clinical usage by this route (Liu and Joseph, 2006).

Local anesthetics inhibit collagen synthesis, but wound healing strength is variably affected. Lidocaine and bupivacaine inhibit collagen synthesis in rat 3T3 and W1-38 fibroblasts by causing a reduction in mucopolysaccharide synthesis (Chvapil et al., 1979), and surgical wound healing in rats is slowed by high procaine concentration (Morris and Appby, 1980). Both lidocaine and articaine lower histologic grade and wound breaking strength in healing rats (Dogan et al., 2003). In contrast, Vasseur et al. (1984) examined the histopathologic appearance and breaking strength of healing midline abdominal wounds in rabbits following saline, 0.5% lidocaine, 2% lidocaine, and 0.5% bupivacaine infiltration. Healing wound breaking strength, as well as histopathologic appearance of local anesthetic-infiltrated tissues, did not vary consistently from the control group. There were similar findings in male guinea pigs, infiltrated with 1% lidocaine, in relation to collagenization, edema, or acute or chronic inflammatory processes (Drucker et al., 1998). In mice, EMLA cream applied twice daily to full-thickness abdominal wall incisions improved wound tensile strength and increased 5-hydroxyproline levels (Eroglu et al., 2001).

Durham et al. (1992) provide an excellent general review of topical ocular anesthetics. Both proparacaine and tetracaine

are commonly used for this purpose. Similar to other aminoester local anesthetics, proparacaine has little antigenic effect and can thus be used in sensitized individuals. In a rabbit study, anterior chamber injection of 0.75% bupivacaine, unpreserved 4% lidocaine, or 0.5% proparacaine produced corneal thickening and opacification that was judged clinically and statistically significant. Tetracaine (0.5%) injection produced corneal thickening and opacification that was clinically apparent in some eyes, but judged to be statistically insignificant (Judge et al., 1997). Corneal sensation, toxicity, and healing time were determined in rabbits for topically applied bupivacaine, lidocaine, procaine, and benzocaine. Onset time was within 1 minute, bupivacaine and lidocaine lasted longer than procaine or benzocaine, and buffered bupivacaine and lidocaine had longer effect than non-buffered solutions; no effect was noted on corneal epithelial healing time or corneal toxicity (Sun et al., 1999). Topical local anesthetics have been proposed for use in ocular irritancy testing, but their use would require continuous administration to be efficacious; long-term use may produce irreversible damage to the cornea (Grant and Acosta, 1994; Moreira et al., 1999).

F. Immune System Effects

The effects of local anesthetics on immune function are complex. Local anesthetics are anti-inflammatory and inhibit neutrophil, leukocyte, and lymphocyte function; antimicrobial properties, however, are also reported. Lidocaine and bupivacaine inhibit metabolic activation of human polymorphonuclear leukocytes and inhibit leukotriene B₄ and interleukin IL-1 production (Sinclair et al., 1993). Phagocytosis and bactericidal activity of neutrophils are enhanced by exposure to bacterial components such as LPS; this process is called priming. Local anesthetics inhibit priming of neutrophils by disparate mechanisms, but all impair upregulation of cytochrome b558 and all impair priming of NADPH oxidase by LPS (Jinnouchi et al., 2005). Neutrophil adhesion, phagocytosis, and the production of superoxide anion and hydrogen peroxide are inhibited by exposure to high (1 mg/ml) levels of lidocaine, procaine, mepivacaine, prilocaine, and tetracaine. At low levels (0.01 mg/ml), only tetracaine inhibits superoxide anion and hydrogen peroxide production (Azuma et al., 2000). In sheep, both lidocaine infiltration above a lymph node and distant IV injection of lidocaine sharply reduce numbers of small recirculating and blast lymphocytes (Moore and Khan, 1986). Lidocaine dose-dependently impairs leukocyte metabolism and random mobility (Hammer et al., 1985), and decreases the number of leukocytes observed in surgically created healing wounds (Eriksson et al., 1992). On the other hand, in a guinea pig wound infection model, infiltration with lidocaine prior to *S. aureus* inoculation decreases bacterial counts more than 70% (Stratford et al., 2002).

VIII. ANESTHETIC COMBINATIONS

Most of the individual drugs discussed above lack one or more of the properties of a practical and safe surgical anesthetic, such as hypnosis, analgesia, or muscle relaxation. This has resulted in attempts to improve the overall quality of injectable anesthesia by combination of two or more drugs. Such balanced anesthesia also improves safety by reducing the dosage, and corresponding side effects, of each component. This concept has been integral to human anesthesiology, in which inhalant agents are typically supplemented with opioids and, often, muscle relaxants. The same goal may be achieved by total IV anesthesia, e.g., with propofol and an opioid (Bailey et al., 2000).

Following are general comments about the types of anesthetic combinations that have been used. The reader is referred to the sections on individual agents in this chapter, the species-specific chapters in this edition, as well the first edition of this text for practical information about their use. There is little information available on the biodisposition of anesthetic drugs when used in combination.

A. Neuroleptanalgesia

Neuroleptanalgesia refers to a combination of an opioid analgesic and a tranquilizer, typically a phenothiazine or butyrophenone dopaminergic receptor antagonist. The combination has synergistic effects on sedation of the animal, and may be sufficient for surgical procedures. Additional drug(s) may be used to produce neuroleptanesthesia or balanced anesthesia, including anticholinergic premedication (Short, 1987).

Fentanyl-fluanisone (Hypnorm) is available in the UK, but not in the US. It has proven to be a valuable injectable drug combination for rodent and rabbit procedures, often combined with a benzodiazepine (Carter, 1983; Flecknell, 1996; Flecknell and Mitchell, 1984; Flecknell et al., 1989). Compared with pentobarbital, systemic blood pressure is 25% lower in Hypnorm-anesthetized Fisher 344 rats; however, skeletal muscle blood flow is fivefold greater and cardiac output is nearly doubled (Skolleborg et al., 1990). Compared with urethane- α -chloralose and TBE anesthesia, midazolam-fentanyl-fluanisone produced more stable hemodynamics in mice, as judged by stable mean arterial blood pressure and heart rate (Jong et al., 2002). On the other hand, using the same hemodynamic parameters, midazolam-fentanyl-fluanisone was judged inferior to ketamine-medetomidine-atropine and isoflurane for use in Swiss, CD-1, BALB/c, and C57BL/6 mice (Zuurbier et al., 2002). Hypnorm significantly increases the level of leukocyte rolling in skin venules; this effect seems to be caused mainly by fentanyl (Janssen et al., 1997). Unlike pentobarbital, Hypnorm produces hyperglycemia in fed, but not fasted, rats (Johansen et al., 1993).

Other neuroleptanalgesic combinations include fentanyl-midazolam (Heys et al., 1989); fentanyl-diazepam (Brown et al.,

1989); fentanyl–etomidate (De Wildt et al., 1983); etorphine–methotrimeprazine (Small Animal Immobilon) (Flecknell et al., 1983); etorphine–acepromazine–atropine (Svendsen and Carter, 1985); and midazolam–xylazine–alfentanil (Borkowski et al., 1990). One neuroleptanalgesic combination formerly in wide use is no longer available: fentanyl–droperidol (Innovar-Vet) (Wixson et al., 1987a–d).

The combination of azaperone with metomidate was reported to produce anesthesia lasting approximately 2 hours, with minimal depression of piglets following cesarean section (Dimigen and Reetz, 1970).

B. Ketamine Combinations

The goals of ketamine combinations include improved analgesia, muscle relaxation and sedation, prolonged duration, and decreased side effects (Muir, 1985). Use of adjunctive agents alters the pharmacokinetics of ketamine, in general leading to a potentiated and prolonged effect (Pascoe, 1992; Waterman, 1983, 1984). Ketamine has been combined with xylazine (Dittmar et al., 2004; Schwenke and Cragg, 2004; Wixson et al., 1987a–d), diazepam (Wixson et al., 1987a–d), midazolam (Gumbleton, 1989), azaperone (Olson and Renchko, 1988), guaifenesin (Olson et al., 1987), pentobarbital (Svensen and Carter, 1985), chlorpromazine (Barzago et al., 1992), medetomidine (DiFilippo et al., 2004; Nevalainen et al., 1989; Taylor et al., 2000), and xylazine–acepromazine (Arras et al., 2001; Welberg et al., 2006).

1. Ketamine–xylazine

Ketamine–xylazine mixtures have variable effects on blood pressure and cardiac output in rats and mice. In male Sprague-Dawley rats, an IP injection of 40/5 mg/kg ketamine/xylazine resulted in a 32.3% decrease in MAP (Wixson et al., 1987c). A dose of 60/7.5 mg/kg ketamine/xylazine decreased MAP by 26.7% or 30–35 mmHg. MAP remained decreased until recovery, which was more than 2 hours at the high dose. IP injection of 40/5 and 60/7.5 mg/kg ketamine/xylazine decreased heart rate by 6 and 27%, respectively. Compared to awake rats, MAP decreased 11% and DS carcinosarcoma blood flow decreased 15.5% in Sprague-Dawley rats given xylazine 1 mg/kg SQ with ketamine 50 mg/kg IP (Menke and Vaupel, 1988). In contrast, 50/5 mg/kg and 100/10 mg/kg ketamine/xylazine IM maintained mean arterial pressure around 110 mmHg for 90 minutes, and between 85 and 100 mmHg for 150 minutes, respectively in male Sprague-Dawley rats (Taie et al., 1999).

An IM injection of 100/5 mg/kg ketamine/xylazine in BALB/c mice resulted in a decrease in MAP from 129 to 100 mmHg, a decrease of 22.5% (Erhardt et al., 1984). Heart rate decreased from 509 to 159 beats/min, and the respiratory rate dropped from 195 to 109 breaths/min. In comparison, 150/15 mg/kg ketamine/xylazine IP reduced heart rate in

SvEv/Tac mice from 658 to 293 beats/min and cardiac output from 13.0 to 7.2 ml/min/g (Yang et al., 1999). Hemodynamic effects of ketamine/xylazine anesthesia were fully antagonized by administration of the α_2 -antagonist atipamezole in CD-1, Swiss, and C57BL6 mice (Janssen et al., 2004).

In male Sprague-Dawley rats, IP ketamine/xylazine doses of 40/5 and 60/7.5 mg/kg decreased arterial pH by about 0.1 pH units with slow recovery back to preanesthetic levels (Wixson et al., 1987c). These same doses of ketamine/xylazine increased PaCO₂ by 35% and decreased PaO₂ by 23–24% or about 18 mmHg. Both PaCO₂ and PaO₂ recovered by 60 minutes after the injection. In contrast, ketamine/xylazine doses of 50/5 mg/kg IM in male Sprague-Dawley rats maintained arterial blood gas values within the physiologically normal range (Taie et al., 1999).

Ketamine/xylazine mixtures also affect blood gas values in mice. IM injection of a 100/5 mg/kg mixture of ketamine/xylazine into BALB/c mice decreased arterial blood pH from 7.285 to 7.122, or 0.16 pH units (Erhardt et al., 1984). Arterial PCO₂ increased from 26.5 to 41.0 mmHg (55%), while PaO₂ decreased from 111.7 to 97.3 mmHg or about 13%.

Ketamine combined with xylazine can increase blood glucose levels. Blood glucose levels in male Sprague-Dawley rats injected with 50/10 mg/kg ketamine/xylazine mixture IP rose to 256 mg/dl, compared to 131 mg/dl in pentobarbital-injected rats (Kawai et al., 1997). In the 9L rat glioma, xylazine alone or in combination with ketamine resulted in hyperglycemia and intratumor pH acidification (Pavlovic et al., 1996). Erhardt et al. (1984) reported no effect of ketamine/xylazine (100/5 mg/kg) on hematocrit when injected IM into mice, implying lack of hemoconcentration due to osmotic diuresis secondary to hyperglycemia.

Using nuclear magnetic resonance perfusion imaging and electron paramagnetic resonance oximetry, Lei et al. (2001) found that in ventilated rats, ketamine at a dose of 50 mg/kg does not induce significant changes in CBF. Ketamine–xylazine in combination, however, causes 25–65% reductions in fore-brain CBF in a region-dependent manner. Addition of xylazine to isoflurane anesthesia results in similar regional reductions in CBF. Ketamine increases while xylazine decreases cortical oxygen partial pressure.

In anesthetized adult male Holtzman Sprague-Dawley rats, ketamine/xylazine does not reduce in vivo antibody levels even 3 weeks after exposure, whereas pentobarbital and chloral hydrate do. Ketamine/xylazine produce moderate but not significant decreases in antibody levels when there is a time lag of 1 week between exposure and antigen administration, but not when it is 3 weeks. Surgery does not produce larger changes in antibody levels than anesthesia itself (Lockwood et al., 1993).

Thompson et al. (2002) investigated the effects of anesthetic agents, including ketamine/xylazine, on hepatic and splenic injury in ICR mice. Injury to lymphocytes and to hepatic Kupffer and endothelial cells occurs within 3 hours, as indicated by marked increases in apoptosis in splenic follicles and in hepatic

Kupffer and endothelial cells, as well as by three to fourfold increase in serum aspartate transaminase. Ketamine/xylazine anesthesia enhances the basal expression of IL-1 β and IL-6 mRNA, and reduces basal TNF α mRNA in male Wistar rat spleen (Bette et al., 2004).

In ex vivo rat studies, Elfving et al. (2003) investigated the interference of ketamine/xylazine with the serotonin re-uptake site, the serotonin(2A) receptor and the dopamine re-uptake site by use of [3 H]-(S)-citalopram, [18 F]altanserin and [125 I]PE2I, respectively. Ketamine/xylazine decreases the target-to-background ratio of [3 H]-(S)-citalopram, but does not affect the ratio of [18 F]altanserin. The [125 I]PE2I target-to-background ratio decreases with ketamine/xylazine.

2. Ketamine–diazepam

In chickens, the combination of ketamine/diazepam does not result in the depth of anesthesia required for major surgical procedures (Christensen et al., 1987).

IP injections of mixtures of ketamine/diazepam result in modest decreases in MAP in rats. A dose of 40/5 mg/kg ketamine/diazepam decreased MAP by 12%. A higher dose of 60/7.5 mg/kg resulted in a transient decrease of 31%, but the MAP was back to baseline value by 30–45 minutes after the injection (Wixson et al., 1987). Neither mixture had significant effects on heart rate, with heart rate decreases of 9 and 12% at the two doses.

Ketamine/diazepam mixtures also affect blood gas values in rats (Wixson et al., 1987c). IP doses of 40/5 and 60/7.5 mg/kg decrease arterial pH in male Sprague-Dawley rats by about 0.05 and 0.08 pH units, respectively. The lower dose of ketamine/diazepam (40/5 mg/kg) results in a PaCO $_2$ increase of 20–30%. The higher dose (60/7.5 mg/kg) transiently increases PaCO $_2$ by 4.9% (about 3–4 mmHg). The 40/5 and 60/7.5 mg/kg doses of ketamine/diazepam result in PaO $_2$ decreases of 23% and 11.5% (8–9 mmHg), respectively.

3. Ketamine–alpha-chloralose

Male CD-1 mice anesthetized with alpha-chloralose (120 mg/kg IP) plus ketamine (100 mg/kg IM) have similar heart rates and blood pressures as mice anesthetized with thiobutabarbital (100 mg/kg IP); renal reabsorption was judged to be more stable with alpha-chloralose (Rieg et al., 2004).

C. Tiletamine–Zolazepam (Telazol)

Telazol, a 1:1 combination of zolazepam (Section II.I) and tiletamine (Section III.B), is indicated for inducing and maintaining anesthesia for short (about 30 minutes) surgical procedures. In an effort to improve effectiveness and reduce adverse side effects, Telazol has been combined with xylazine

or medetomidine (Buchanan et al., 1998), and ketamine and xylazine (Ko et al., 1995).

Marked species differences in analgesic effectiveness, drug response, and rate of elimination, as well as substantial inter-animal pharmacokinetic variability, are reported (Chen et al., 1969; Kumar et al., 2006). Although useful for surgical anesthesia in rats (Silverman et al., 1983), ferrets (Payton and Pick, 1989), gerbils (Hrapkiewicz et al., 1989), dogs and cats (Tracy et al., 1988), nociception is not eliminated in mice, hamsters (Silverman et al., 1983), guinea pigs, and rabbits (Ward et al., 1974), even at relatively high dosages associated with prolonged recumbency. Telazol does not produce analgesia in New Zealand White rabbits and is nephrotoxic at both 32 and 64 mg/kg (Brammer et al., 1991).

The pharmacology of Telazol has been reviewed (Lin et al., 1993). In domestic pigs, tiletamine level decreases faster than that of zolazepam (terminal elimination rate constant of 0.26/h for tiletamine versus 0.11/h for zolazepam), with half-lives for tiletamine and zolazepam in the terminal elimination period phase of 3.7 and 8.4 hours, respectively (Kumar et al., 2006). Semple et al. (2000) reported half-lives of 1.8 hours for tiletamine and 1.2 hours for zolazepam in the polar bear *Ursus maritimus*, with total clearance values of 2.1 and 1.1 L/h/kg for tiletamine and zolazepam, respectively. A 1-compartment model with first-order absorption and elimination best fits the time-series data for the drugs in serum during the immobilization period.

In ex vivo rat studies, Elfving et al. (2003) investigated the interference of Telazol anesthesia with the serotonin re-uptake site, the serotonin(2A) receptor and the dopamine re-uptake site by use of [3 H]-(S)-citalopram, [18 F]altanserin and [125 I]PE2I, respectively. The target-to-background ratios of [3 H]-(S)-citalopram and [125 I]PE2I remain unaltered with Telazol.

D. Other Anesthetic Combinations

Urethane increases the solubility of alpha-chloralose, and complements some of its shortcomings; analgesia is provided, excess muscle activity is reduced, and exaggerated spinal reflex activity and CNS stimulation are suppressed (Green, 1979). Kazerani and Furman (2006) examined the effect of 40 mg/kg LPS in C57BL/6 mice anesthetized with 1000 mg/kg urethane combined with 50 mg/kg chloralose. Hypoglycemia and increased serum alanine aminotransferase levels were observed during endotoxemia, but the expected LPS-induced increases in lipase and lung myeloperoxidase activity (an indicator of neutrophil infiltration) were absent, leading to the conclusion that chloralose/urethane anesthesia seemingly protects mice against LPS-mediated damage in the exocrine pancreas and lung, and that this combination should not be used in murine endotoxemia studies.

The shortcomings of chloralose also may be counteracted by combination with other preanesthetic medications. Other reported anesthetic combinations include guaifenesin and pentobarbital (Olson et al., 1987), fentanyl-medetomidine (Hu et al., 1992), medetomidine-propofol or medetomidine-midazolam-propofol (Ko et al., 1992), medetomidine-ketamine-diazepam (Mero et al., 1989), and TBE-medetomidine (Gopalan et al., 2005).

In studies of mesenteric arteriolar microvascular reactivity in vivo, chloral hydrate (500 mg/kg SQ) was judged to be more appropriate than xylazine-ketamine (33/167 mg/kg SQ) (Rodrigues et al., 2006).

REFERENCES

- Aanta, R., Marjamaki, A., and Scheinin, M. (1995). Molecular pharmacology of α_2 -adrenoceptor subtypes. *Ann. Med.* **27**, 439–449.
- Accorsi-Mendonca, D., Leao, R.M., Aguiar, J.F., Varanda, A.A., and Machado, B.H. (2007). Urethane inhibits the GABAergic neurotransmission in the nucleus of the solitary tract of rat brain stem slices. *Am. J. Physiol. Regul. Comp. Physiol.* **292**, R396–R402.
- Adam, H.K., Glen, J.B., and Hoyle, P.A. (1980). Pharmacokinetics in laboratory animals of ICI 35 868, a new I.V. anaesthetic agent. *Br. J. Anaesth.* **52**, 743–746.
- Adams, H.R. (1970). Prolongation of barbiturate anesthesia by chloramphenicol in laboratory animals. *J. Am. Vet. Med. Assoc.* **157**, 1908–1913.
- Adams, H.R., and Dixit, B.N. (1970). Prolongation of pentobarbital anesthesia by chloramphenicol in dogs and cats. *J. Am. Vet. Med. Assoc.* **156**, 902–905.
- Adolph, E.F. (1949). Quantitative relations in the physiological constitutions of mammals. *Science* **109**, 579–585.
- Aeschbacher, G., and Webb, A.I. (1993a). Propofol in rabbits. 1. Determination of an induction dose. *Lab. Anim. Sci.* **43**, 324–327.
- Aeschbacher, G., and Webb, A.I. (1993b). Propofol in rabbits 2. Long-term anesthesia. *Lab. Anim. Sci.* **43**, 328–335.
- Agostino, D., and Clifton, E.E. (1964). Anesthetic effect on pulmonary metastases in rats. *Arch. Surg.* **88**, 735–739.
- Aisaka, K., Mitani, A., Kitajima, Y., Ohno, T., and Ishihara, T. (1991). Difference in pressor responses to NG-monomethyl-L-arginine between conscious and anesthetized rats. *Jpn. J. Pharmacol.* **56**, 245–248.
- Åkerman, B. (1988). On the chemistry and pharmacology of local anaesthetic agents. In "Local Anaesthesia and Regional Blockade." (J.B. Löström and U. Sjöstrand, eds.), pp 1–22. Elsevier, Amsterdam.
- Akwa, Y., and Baulieu, E.E. (1999). Neurosteroids: Behavioral aspects and physiological implications. *J. Soc. Biol.* **193**, 293–298.
- Albrecht, D., and Davidowa, H. (1989). Action of urethane on dorsal lateral geniculate neurons. *Brain Res. Bull.* **22**, 923–927.
- Aldridge, W.N., and Parker, V.H. (1960). Barbiturates and oxidative phosphorylation. *Biochem. J.* **76**, 47–56.
- Alfaro, V., and Palacios, L. (1992). Differential effects of hypothermia upon blood acid–base state and blood gases in sodium pentobarbital and urethane anesthetized rats. *Gen. Pharmacol.* **23**, 677–682.
- Altura, B.M., Altura, B.T., Carella, A., Turlapaty, P.D.M.V., and Weinburg, J. (1980). Vascular smooth muscle and general anesthetics. *Fed. Proc.* **39**, 1584–1591.
- Altura, B.T., and Altura, B.M. (1975). Pentobarbital and contraction of vascular smooth muscle. *Am. J. Physiol.* **229**, 1635–1640.
- American Veterinary Medical Association. (2001). 2000 Report of the AVMA Panel on Euthanasia. *J. Am. Vet. Med. Assoc.* **218**, 660–696.
- Andaluz, A., Tusell, J., Trasserres, O., Cristofol, C., Capece, B.P.S.C., Arboix, M., and Garcia, F. (2003). Transplacental transfer of propofol in pregnant ewes. *Vet. J.* **166**, 198–204.
- Andress, J.L., Day, T.K., and Day, D. (1995). The effects of consecutive day propofol anesthesia on feline red blood cells. *Vet. Surg.* **24**, 277–282.
- Antognini, J.F., Barter, L., and Carstens, E. (2005). Overview movement as an index of anesthetic depth in humans and experimental animals. *Comp. Med.* **55**, 413–418.
- Antognini, J.F., and Carstens, E. (2002). In vivo characterization of clinical anaesthesia and its components. *Br. J. Anaesth.* **89**, 156–166.
- Arras, M., Autenried, P., Rettich, A., Spaeni, D., and Rulicke, T. (2001). Optimization of intraperitoneal injection anesthesia in mice: Drugs, dosages, adverse effects, and anesthesia depth. *Comp. Med.* **51**, 443–456.
- Atkinson, P.M., Taylor, D.I., and Chetty, N. (1985). Inhibition of platelet aggregation by ketamine hydrochloride. *Thromb. Res.* **40**, 227–234.
- Aurori, K.C., and Vesell, E.S. (1974). Comparative stimulatory effects of four phenothiazines on hepatic microsomal enzymes. *Drug. Metab. Dispos.* **2**, 566–572.
- Avila, M.Y., Carre, D.A., Stone, R.A., and Civan, M.M. (2001). Reliable measurement of mouse intraocular pressure by a servo-null micropipette system. *Invest. Ophthalmol. Vis. Sci.* **42**, 1841–1846.
- Aynsley-Green, A., Biebuyck, J.F., and Alberti, K.G. (1973). Anaesthesia and insulin secretion: The effects of diethyl ether, halothane, pentobarbitone sodium and ketamine hydrochloride on intravenous glucose tolerance and insulin secretion in the rat. *Diabetologia* **9**, 274–281.
- Azadegan, A., Johnson, D.W., and Stowe, C.M. (1980). Influence of time interval between administration of chloramphenicol and thiamylal on the sleeping time of mice. *Am. J. Vet. Res.* **41**, 976–977.
- Azuma, Y., Shinohara, M., Wang, P.L., Suese, Y., Yasuda, H., and Ohura, K. (2000). Comparison of inhibitory effects of local anesthetics on immune functions of neutrophils. *Int. J. Immunopharmacol.* **22**, 789–796.
- Badger, D.A., Smith, R.L., Bao, J., Kuester, R.K., and Sipes, I.G. (2002). Disposition and metabolism of isoeugenol in the male Fischer 344 rat. *Food Chem. Toxicol.* **40**, 1757–1765.
- Bailey, P.L., Egan, T.D., and Stanley, T.H. (2000). Intravenous opioid anesthetics. In "Anesthesia." (R.D. Miller, ed.), 5th ed., pp 273–376. Churchill Livingstone, Philadelphia, PA.
- Baldessarini, R.J. (1990). Drugs and the treatment of psychiatric disorders. In "Goodman and Gilman's The Pharmacological Basis of Therapeutics." (A.G. Gilman, T.W. Rall, A.S. Nies, and P. Taylor, eds.), 8th ed., pp 383–435. Pergamon Press, New York.
- Baldessarini, R.J., and Tarazi, F.I. (2006). Pharmacotherapy of psychosis and mania. In "Goodman and Gilman's The Pharmacological Basis of Therapeutics." (L.L. Brunton, J.S. Lazo, and K.L. Parker, eds.), 11th ed., pp 461–500. McGraw-Hill, New York.
- Banaszczyk, M.G., Carlo, A.T., Millan, V., Lindsey, A., Moss, R., Carlo, D.J., and Hendler, S.S. (2002). Propofol propofol, a water-soluble propofol prodrug: In vivo evaluation. *Anesth. Analg.* **95**, 1285–1292.
- Barr, S.C., Ludders, J.W., Looney, A.L., Gleed, R.D., and Erb, H.N. (1992). Platelet aggregation in dogs after sedation with acepromazine and atropine and during subsequent general anesthesia and surgery. *Am. J. Vet. Res.* **53**, 2067–2070.
- Barrett, J.D., Eggena, P., and Krall, J.F. (1988). Independent change of plasma and tissue renin in response to anesthetics. *Clin. Exp. Hypertens.* **A10**, 757–765.
- Barzago, M.M., Bortolotti, A., Omarini, D., Aramayona, J.J., and Bonati, M. (1992). Monitoring of blood gas parameters and acid–base balance of pregnant and non-pregnant rabbits (*Oryctolagus cuniculus*) in routine experimental conditions. *Lab. Anim.* **26**, 73–79.
- Batjer, H.H. (1993). Cerebral protective effects of etomidate: Experimental and clinical aspects. *Cerebrovasc. Brain Metab. Rev.* **5**, 17–32.
- Belant, J.L., and Seamans, T.W. (1999). Alpha-chloralose immobilization of rock doves in Ohio. *J. Wildl. Dis.* **35**, 239–242.
- Bellman, M.H., and Pleuvry, B.J. (1981). Comparison of the respiratory effects of ICI 35 868 and thiopentone in the rabbit. *Br. J. Anaesth.* **53**, 425–429.
- Ben-Eliyahu, S., Shakhar, G., Rosenne, E., Levinson, Y., and Beilin, B. (1999). Hypothermia in barbiturate-anesthetized rats suppresses natural killer

- cell activity and compromises resistance to tumor metastasis: A role for adrenergic mechanisms. *Anesthesiology* **91**, 732–740.
- Benson, G.J., and Thurmon, J.C. (1987). Species difference as a consideration in alleviation of animal pain and distress. *J. Am. Vet. Med. Assoc.* **191**, 1227–1230.
- Bette, M., Schlimme, S., Mutters, R., Menendez, S., Hoffmann, S., and Schulz, S. (2004). Influence of different anaesthetics on pro-inflammatory cytokine expression in rat spleen. *Lab. Anim.* **38**, 272–279.
- Beyers, T.M., Richardson, J.A., and Prince, M.D. (1991). Axonal degeneration and self-mutilation as a complication of the intramuscular use of ketamine and xylazine in rabbits. *Lab. Anim. Sci.* **41**, 519–520.
- Blake, D.W., Blombery, P.A., and Korner, P.I. (1982). Effect of ketamine, althesin, and thiopentone on the valsalva-constrictor and heart rate reflexes of the rabbit. *J. Auton. Nerv. Syst.* **5**, 291–301.
- Blake, D.W., Jover, B., and McGrath, B.P. (1988). Haemodynamic and heart rate reflex responses to propofol in the rabbit. *Br. J. Anaesth.* **61**, 194–199.
- Bloom, F.E. (2006). Neurotransmission and the central nervous system. In “Goodman and Gilman’s Pharmacological Basis of Therapeutics.” (L.L. Brunton, J.S. Lazo, and K.L. Parker, eds.), 11th ed., pp 330–331. McGraw-Hill Medical Publishing Division, New York.
- Bogdan, L.G., Glisson, S.N., and El-Etr, A.A. (1974). The effect of ketamine upon depolarizing and non-depolarizing neuromuscular blockade in rabbit. *Naunyn-Schmiedberg’s Arch. Pharmacol.* **285**, 223–231.
- Booker, J.L., Erickson, H.H., and Fitzpatrick, E.L. (1982). Cardiodynamics in the macaque during dissociative anesthesia. *Am. J. Vet. Res.* **43**, 671–675.
- Booth, N.H. (1988a). Intravenous and other parenteral anesthetics. In “Veterinary Pharmacology and Therapeutics.” (N.H. Booth and L.E. McDonald, eds.), 6th ed., pp 212–274. Iowa State University Press, Ames, IA.
- Booth, N.H. (1988b). Psychotropic agents. In “Veterinary Pharmacology and Therapeutics.” (N.H. Booth and L.E. McDonald, eds.), 6th ed., pp 363–395. Iowa State University Press, Ames, IA.
- Booth, N.H. (1988c). Local anesthetics. In “Veterinary Pharmacology and Therapeutics.” (N.H. Booth and L.E. McDonald, eds.), 6th ed., pp 407–423. Iowa State University Press, Ames, IA.
- Borkowski, G.L., Danneman, P.J., Russell, G.B., and Lang, C.M. (1990). An evaluation of three intravenous anesthetic regimens in New Zealand rabbits. *Lab. Anim. Sci.* **40**, 270–276.
- Boscan, P., Steffey, E.P., Farver, T.B., Mama, K.R., Huang, N.J., and Harris, S.B. (2006). Comparison of high (5%) and low (1%) concentrations of micellar microemulsion propofol formulations with a standard (1%) lipid emulsion in horses. *Am. J. Vet. Res.* **67**, 1476–1483.
- Bostrom, I., Nyman, G., Kampa, N., Haggstrom, J., and Lord, P. (2003). Effects of acepromazine on renal function in anesthetized dogs. *Am. J. Vet. Res.* **64**, 590–598.
- Boucher, M., Dubray, C., Li, J.H., Paire, M., and Duchêne-Marullaz, P. (1991). Influence of pentobarbital and chloralose anesthesia on quinidine-induced effects on atrial refractoriness and heart rate in the dog. *J. Cardiovasc. Pharmacol.* **17**, 199–206.
- Bowery, N.G., and Dray, A. (1978). Reversal of the action of amino acid antagonists by barbiturates and anesthetic drugs. *Br. J. Pharmacol.* **63**, 197–215.
- Box, P.G., and Ellis, K.R. (1973). Use of CT1341 anaesthetic (‘Saffan’) in monkeys. *Lab. Anim.* **7**, 161–170.
- Boylard, E., and Rhoden, E. (1949). The distribution of urethane in animal tissues, as determined by a microdiffusion method, and the effect of urethane treatment on enzymes. *Biochem. J.* **44**, 528–531.
- Bradshaw, E.G., and Pleuvry, B.J. (1971). Respiratory and hypnotic effects of nitrazepam, diazepam and pentobarbitone and their solvents in the rabbit and the mouse. *Br. J. Anaesth.* **43**, 637–643.
- Brammer, D.W., Doerning, B.J., Chrisp, C.E., and Rush, H.G. (1991). Anesthetic and nephrotoxic effects of Telazol® in New Zealand white rabbits. *Lab. Anim. Sci.* **41**, 432–435.
- Branson, K.R. (2001). Injectable anesthetics. In “Veterinary Pharmacology and Therapeutics.” (H.R. Adams, ed.), 8th ed., pp 213–267. Iowa State Press, Ames, IA.
- Branson, K.R., and Booth, N.H. (1995). Injectable anesthetics. In “Veterinary Pharmacology and Therapeutics.” (H.R. Adams, ed.), 7th ed., pp 179–208. Iowa State University Press, Ames, IA.
- Braun, R.D., Dewhirst, M.W., and Hatchell, D.L. (1997). Quantification of erythrocyte flow in the choroid of the albino rat. *Am. J. Physiol.* **272**, H1444–H1453.
- Bree, M.M., and Cohen, B.J. (1965). Effects of urethane anesthesia on blood and blood vessels in rabbits. *Lab. Anim. Care* **15**, 254–259.
- Bree, M.M., Cohen, B.J., and Abrams, G.D. (1971). Injection lesions following intramuscular administration of chlorpromazine in rabbits. *J. Am. Vet. Med. Assoc.* **159**, 1598–1602.
- Briancau, P., Chevalier, H., Karas, A., Court, M.H., Bassage, L., Kirker-Head, C., Provost, P., and Paradis, M.R. (2002). Intravenous lidocaine and small-intestinal size, abdominal fluid, and outcome after colic surgery in horses. *J. Vet. Intern. Med.* **16**, 736–741.
- British Veterinary Association Animal Welfare Foundation/Fund for the Replacement of Animals in Medical Experiments/Royal Society for the Prevention of Cruelty to Animals/Universities Federation for Animal Welfare. Refinement and reduction in production of genetically modified mice. (2003). Sixth report of the BVA/AVF/FRAME/RSPCA/UFPAW Joint Working Group on Refinement. Anaesthesia, analgesia and perioperative care. *Lab. Anim. (UK)* **37**(Suppl. 1), 17–20.
- Britton, K.T., Page, M., Baldwin, H., and Koob, G.F. (1991). Anxiolytic activity of steroid anesthetic alphaxalone. *J. Pharmacol. Exp. Ther.* **258**, 124–128.
- Brodin, P., and Roed, A. (1984). Effects of eugenol on rat phrenic nerve and phrenic nerve-diaphragm preparations. *Arch. Oral. Biol.* **29**, 611–615.
- Brogden, R.N., and Goa, K.L. (1991). Flumazenil: A reappraisal of its pharmacological properties and therapeutic efficacy as a benzodiazepine antagonist. *Drugs* **42**, 1061–1089.
- Bronley-DeLancey, A., McMillan, D.C., McMillan, J.M., Jollow, D.J., Mohr, L.C., and Hoel, D.G. (2006). Application of cryopreserved human hepatocytes in trichloroethylene risk assessment: Relative disposition of chloral hydrate to trichloroacetate and trichloroethanol. *Environ. Health Perspect.* **114**, 1237–1242.
- Brown, N.J., Thorne, P.R., and Nuttall, A.L. (1989). Blood pressure and other physiological responses in awake and anesthetized guinea pigs. *Lab. Anim. Sci.* **39**, 142–148.
- Browning, S., Lawrence, D., Livingston, A., and Morris, B. (1982). Interactions of drugs active at opiate receptors and drugs active at a₂-receptors on various test systems. *Br. J. Pharmacol.* **77**, 487–491.
- Bryan, C.E., Skipper, H.E., and White, L. (1949). Carbamates in the chemotherapy of leucemia. IV. The distribution of radioactivity in tissues of mice following injection of carbonyl-labeled urethane. *J. Biol. Chem.* **177**, 941–950.
- Buchanan, K.C., Burge, R.R., and Ruble, G.R. (1998). Evaluation of injectable anesthetics for major survival procedures in guinea pigs. *Contemp. Top. Lab. Anim. Sci.* **37**, 58–63.
- Buelke-Sam, J., Holson, J.F., Bazare, J.J., and Young, J.F. (1978). Comparative stability of physiological parameters during sustained anesthesia in rats. *Lab. Anim. Sci.* **28**, 157–162.
- Buetow, B.S., Chen, L.L., Maggio-Price, L., and Swisshelm, K. (1999). Peritonitis in nude mice in a xenograft study. *Contemp. Top. Lab. Anim. Sci.* **38**, 47–49.
- Bunting, P., Ramsay, T.M., and Pleuvry, B.J. (1989). An in-vitro study of the interactions between intravenous induction agents and the calcium antagonists verapamil and nifedipine. *J. Pharm. Pharmacol.* **41**, 840–843.
- Burns, C.A., Ferris, G., Feng, C., Cooper, J.Z., and Brown, M.D. (2006). Decreasing the pain of local anesthesia: A prospective, double-blind comparison of buffered, premixed 1% lidocaine with epinephrine versus 1% lidocaine freshly mixed with epinephrine. *J. Am. Acad. Dermatol.* **54**, 128–131.

- Butterworth, J.F. IV, and Strichartz, G.R. (1990). Molecular mechanisms of local anesthesia: A review. *Anesthesiology* **72**, 711–734.
- Cain, D.P., Raithby, A., and Corcoran, M.E. (1989). Urethane anesthesia blocks the development and expression of kindled seizures. *Life Sci.* **44**, 1201–1206.
- Calderone, L., Grimes, P., and Shalev, M. (1986). Acute reversible cataract induced by xylazine and by ketamine–xylazine anesthesia in rats and mice. *Exp. Eye Res.* **42**, 331–337.
- Caldwell, J.C., and Keshava, N. (2006). Key issues in the modes of action and effects of trichloroethylene metabolites for liver and kidney tumorigenesis. *Environ. Health Perspect.* **114**, 1457–1463.
- Carmichael, F.J., Crawford, M.W., Khayyam, N., and Saldivia, V. (1993). Effect of propofol infusion on splanchnic hemodynamics and liver oxygen consumption in the rat. *Anesthesiology* **79**, 1051–1060.
- Carruba, M.O., Bondiolotti, G., Picotti, G.B., Catteruccia, N., and Da Prada, M. (1987). Effects of diethyl ether, halothane, ketamine and urethane on sympathetic activity in the rat. *Eur. J. Pharmacol.* **134**, 15–24.
- Carter, A.M. (1983). Acid–base status of pregnant guinea pigs during neuroleptanalgesia with diazepam and fentanyl–fluanisone. *Lab. Anim.* **17**, 114–117.
- Catterall, W.A., and Mackie, K. (2006). Local anesthetics. In “Goodman and Gilman’s The Pharmacological Basis of Therapeutics.” (L.L. Brunton, J.S. Lazo, and K.L. Parker, eds.), pp 369–386. McGraw-Hill, New York.
- Celesia, G.G., Chen, R.C., and Bamforth, B.J. (1975). Effects of ketamine in epilepsy. *Neurology* **25**, 169–172.
- Celleno, D., Capogna, G., Emanuelli, M., Varrassi, G., Muratori, F., Costantino, P., and Sebastiani, M. (1993). Which induction drug for cesarean section? A comparison of thiopental sodium, propofol, and midazolam. *J. Clin. Anesth.* **5**, 284–288.
- Chang, T., and Glazko, A.J. (1974). Biotransformation and disposition of ketamine. *Int. Anesthesiol. Clin.* **12**, 157–177.
- Chaplin, M.D., Roszkowski, A.P., and Richards, R.K. (1973). Displacement of thiopental from plasma proteins by nonsteroidal anti-inflammatory agents. *Proc. Soc. Exp. Biol. Med.* **143**, 667–671.
- Chappel, S.C., and Barraclough, C.A. (1976). The effects of sodium pentobarbital or ether anesthesia on spontaneous and electrochemically-induced gonadotropin release. *Proc. Soc. Exp. Biol. Med.* **153**, 1–6.
- Charney, D.S., Mihic, S.J., and Harris, R.A. (2006). Hypnotics and sedatives. In “Goodman & Gilman’s The Pharmacological Basis of Therapeutics.” (L.L. Brunton, J.S. Lazo, and K.L. Parker, eds.), 11th ed., pp 4404–4405. The McGraw-Hill Companies, Inc, New York.
- Chen, G., Ensor, C.R., and Bohner, B. (1969). The pharmacology of 2-(ethylamino)-2-(2-thienyl)-cyclohexanone_HCl (CI-634). *J. Pharmacol. Exp. Ther.* **168**, 171–179.
- Cheney, D.H., Slogoff, S., and Allen, G.W. (1974). Ketamine-induced stress ulcers in the rat. *Anesthesiology* **40**, 531–535.
- Child, K.J., English, A.F., Gilbert, H.G., and Woollett, E.A. (1972b). An endocrinological evaluation of Althesin (CT 1341) with special reference to reproduction. *Postgrad. Med. J.* (June Suppl.), 51–55.
- Child, K.J., Gibson, W., Harnby, G., and Hart, J.W. (1972a). Metabolism and excretion of Althesin (CT 1341) in the rat. *Postgrad. Med. J.* (June Suppl.), 37–42.
- Chimoskey, J.E., Huntsman, L.L., Gams, E., and Flanagan, W.J. (1975). Effect of ketamine on ventricular dynamics of unanesthetized baboons. *Cardiovasc. Res. Center Bull.* **14**, 53–57.
- Christensen, J., Fosse, R.T., Halvorsen, O.J., and Morild, I. (1987). Comparison of various anesthetic regimens in the domestic fowl. *Am. J. Vet. Res.* **48**, 1649–1657.
- Chvapil, M., Hameroff, S.R., O’Dea, K., and Peacock, E.E., Jr. (1979). Local anesthetics and wound healing. *J. Surg. Res.* **27**, 367–371.
- Clanachan, A.S., McGrath, J.C., and MacKenzie, J.E. (1976). Cardiovascular effects of ketamine in the pithed rat, rabbit and cat. *Br. J. Anaesth.* **48**, 935–939.
- Clark, S.M., and Lipton, J.M. (1981). Effects of diazepam on body temperature of the aged squirrel monkey. *Brain Res. Bull.* **7**, 5–9.
- Clemens, L.G., Popham, T.V., and Ruppert, P.H. (1979). Neonatal treatment of hamsters with barbiturate alters adult sexual behavior. *Dev. Psychol.* **12**, 49–59.
- Cockshott, I.D., Douglas, E.J., Plummer, G.F., and Simons P.J. (1992). The pharmacokinetics of propofol in laboratory animals. *Xenobiotica* **22**, 369–375.
- Coetzee, A., Fourie, P., Coetzee, J., Badenhorst, E., Rebel, A., Bolliger, C., Uebel, R., Wium, C., and Lombard, C. (1989). Effect of various propofol plasma concentrations on regional myocardial contractility and left ventricular afterload. *Anesth. Analg.* **69**, 473–483.
- Cohen, M.L., Chan, S.-L., Way, W.L., and Trevor, A.J. (1973). Distribution in the brain and metabolism of ketamine in the rat after intravenous administration. *Anesthesiology* **39**, 370–376.
- Cohen, R.G., Hartstein, M., Lahav, M., and Woog, J.J. (1996). Ocular toxicity following topical application of anesthetic cream to the eyelid skin. *Ophthalmic Surg. Lasers* **27**, 374–377.
- Collado, P.S., Pozo-Andrada, M.J., González, J., Jiménez, R., and Esteller, A. (1987). Effect of pentobarbital or urethane on bile secretion and chemical composition of blood in the rabbit. *Lab. Anim.* **21**, 11–17.
- Collins, T.B., Jr., and Lott, D.F. (1968) Stock and sex specificity in the response of rats to pentobarbital sodium. *Lab. Anim. Care* **18**, 192–194.
- Commissaris, R.L., Semsyn, D.R., and Rech, R.H. (1982). Dispositional without functional tolerance to the hypothermic effects of pentobarbital in the rat. *J. Pharmacol. Exp. Ther.* **220**, 536–539.
- Conney, A.H., Davison, C., Gastel, R., and Burns, J.J. (1960). Adaptive increases in drug-metabolizing enzymes induced by phenobarbital and other drugs. *J. Pharmacol. Exp. Ther.* **130**, 1–8.
- Cotter, P.A., and Rodnick, K.J. (2006). Differential effects of anesthetics on electrical properties of the rainbow trout (*Oncorhynchus mykiss*) heart. *Comp. Biochem. Physiol. A Mol. Integr. Physiol.* **145**, 158–165. Epub 2006 Jun 7.
- Court, M.H., Duan, S.X., Hesse, L.M., Venkatakrishnan, K., and Greenblatt, D.J. (2001). Cytochrome P-450 2B6 is responsible for interindividual variability of propofol hydroxylation by human liver microsomes. *Anesthesiology* **94**, 110–119.
- Court, M.H., Hay-Kraus, B.L., Hill, D.W., Kind, A.J., and Greenblatt, D.J. (1999). Propofol hydroxylation by dog liver microsomes: Assay development and dog breed differences. *Drug Metab. Dispos.* **27**, 1293–1299.
- Covert, R.F., Drummond, W.H., and Gimotty, P.A. (1988). Chloralose alters circulatory response to a-receptor stimulation and blockade. *Am. J. Physiol.* **255**, H419–H425.
- Cox, R.H. (1972). Influence of chloralose anesthesia on cardiovascular function in trained dogs. *Am. J. Physiol.* **223**, 660–667.
- Craigmill, A.L., Sundlof, S.F., and Riviere, J.E. (1994). “Handbook of Comparative Pharmacokinetics and Residues of Veterinary Therapeutic Drugs.” CRC Press, Boca Raton, FL.
- Crawford, K., Gabelt, B.T., Kaufman, P.L., and Bito, L.Z. (1990). Effects of various anesthetic and autonomic drugs on refraction in monkeys. *Curr. Eye Res.* **9**, 525–532.
- Cunliffe-Beamer, T.L., Freeman, L.C., and Myers, D.D. (1981). Barbiturate sleep time in mice exposed to autoclaved or unautoclaved wood beddings. *Lab. Anim. Sci.* **31**, 672–675.
- Cupples, W.A., Veress, A.T., and Sonnenberg, H. (1982). Lack of effect of barbiturate and ketamine anesthesia on renal blood flow in chronically instrumented rats prepared for micropuncture. *Can. J. Physiol. Pharmacol.* **60**, 204–205.
- Dada, M.O., Campbell, G.T., Horacek, M.J., and Blake, C.A. (1992). Intraperitoneal injection of chloral hydrate causes intra-abdominal adhesions and unilateral testicular atrophy in golden Syrian hamsters. *Life Sci.* **51**, 29–35.
- da Motta, P.G., Veiga, A.P., Francischi, J.N., and Tatsuo, M.A. (2004). Evidence for participation of GABA(A) receptors in a rat model of secondary hyperalgesia. *Eur. J. Pharmacol.* **483**, 233–239.
- Daniel, F.B., DeAngelo, A.B., Stober, J.A., Olson, G.R., and Page N.P. (1992). Hepatocarcinogenicity of chloral hydrate, 2-chloroacetaldehyde, and

- dichloroacetic acid in the male B6C3F1 mouse. *Fundam. Appl. Toxicol.* **19**, 159–168.
- Dart, A.J., and Hodgson, D.R. (1998). Role of prokinetic drugs for treatment of postoperative ileus in the horse. *Aust. Vet. J.* **76**, 25–31.
- Daunt, D.A., Dunlop, C.I., Chapman P.L., Shafer, S.L., Ruskoaho, H., Vakkuri, O., Hodgson, D.S., Tyler, L.M., and Maze, M. (1993). Cardiopulmonary and behavioral responses to computer-driven infusion of detomidine in standing horses. *Am. J. Vet. Res.* **54**, 2075–2082.
- Daunt, D.A., and Maze, M. (1992). α_2 -adrenergic agonist receptors, sites, and mechanisms of action. In "Animal Pain." (C.E. Short and A. Van Poznak, eds.), pp 165–180. Churchill Livingstone, New York.
- Davis, D.W., Mans, A.M., Biebuyck, J.F., and Hawkins, R.A. (1986). Regional brain glucose utilization in rats during etomidate anesthesia. *Anesthesiology* **64**, 751–757.
- Davis, J.A., Greenfield, R.E., and Brewer, T.G. (1993). Benzocaine-induced methemoglobinemia attributed to topical application of the anesthetic in several laboratory animal species. *Am. J. Vet. Res.* **54**, 1322–1326.
- Davis, K., and Griffin, B. (2003). Physiological responses of hybrid striped bass under sedation. *Aquaculture* **233**, 531–548.
- Davis, L.E., Davis, C.H., and Baggot, J.D. (1973). Comparative pharmacokinetics in domesticated animals. In "Research Animals in Medicine." (L.T. Harmison, ed.), pp 715–733. DHEW Publication No. (NIH) 72-333, U.S. Department of Health, Education, and Welfare, Bethesda MD.
- De Paepe, P., Belpaire, F.M., Rosseel, M.T., Van Hoey, G., Boon, P.A., and Buylaert, W.A. (2000). Influence of hypovolemia on the pharmacokinetics and the electroencephalographic effect of propofol in the rat. *Anesthesiology* **93**, 1482–1490.
- De Paepe, P., Belpaire, F.M., Van Hoey, G., Boon, P.A., and Buylaert, W.A. (1999). Influence of hypovolemia on the pharmacokinetics and the electroencephalographic effect of etomidate in the rat. *J. Pharmacol. Exp. Ther.* **290**, 1048–1053.
- Desmedt, L.K.C., Van Bruggen, J.A.A., and Niemegeers, C.J.E. (1975). The effects of azaperone, a sedative neuroleptic of the butyrophenone series, on dominant–subordinate behavior in Wistar rats competing for food. *Psychopharmacology* **41**, 285–289.
- Dewhirst, M.W., Ong, E., Rosner, G., Rehms, S., Shan, S., Braun, R., Brizel, D., and Secomb, T. (1996). Arteriolar oxygenation in tumor and subcutaneous arterioles: Effects of inspired air oxygen content. *Br. J. Cancer* **74**, S247–S251.
- De Wildt, D.J., Hillen, F.C., Rauws, A.G., and Sangster, B. (1983). Etomidate-anaesthesia, with and without fentanyl, compared with urethane-anaesthesia in the rat. *Br. J. Pharmacol.* **79**, 461–469.
- Dhasmana, K.M., Saxena, P.R., Prakash, O., and Van Der Zee, H.T. (1984). A study on the influence of ketamine on systemic and regional haemodynamics in conscious rabbits. *Arch. Int. Pharmacodyn.* **269**, 323–334.
- DiFilippo, S.M., Norberg, P.J., Suson, U.D., Savino, A.M., and Reim, D.A. (2004). A comparison of xylazine and medetomidine in an anesthetic combination in New Zealand White rabbits. *Contemp. Top. Lab. Anim. Sci.* **43**, 32–34.
- Dimigen, J., and Reetz, I. (1970). Clinical trials with analgesia in the swine using the neuroleptic Azaperone and the hypnotic Metomidate. I [Article in German]. *Dtsch. Tierärztl. Wochenschr.* **77**, 470–473.
- Dittmar, M.S., Fehm, N.P., Vatankhah, B., and Horn, M. (2004). Ketamine/xylazine anesthesia for radiologic imaging of neurologically impaired rats: Dose response, respiratory depression, and management of complications. *Comp. Med.* **54**, 652–655.
- Dodam, J.R., Kruse-Elliott, K.T., Aucoin, D.P., and Swanson, C.R. (1990). Duration of etomidate-induced adrenocortical suppression during surgery in dogs. *Am. J. Vet. Res.* **51**, 786–788.
- Doenicke, A., Roizen, M.F., Hoerneck, R., Mayer, M., Ostwald, P., and Foss, J. (1997). Haemolysis after etomidate: Comparison of propylene glycol and lipid formulations. *Br. J. Anaesth.* **79**, 386–388.
- Doerning, B.J., Brammer, D.W., Chrisp, C.E., and Rush, H.G. (1992). Nephrotoxicity of tiletamine in New Zealand white rabbits. *Lab. Anim. Sci.* **42**, 267–269.
- Dogan, N., Ucok, C., Korkmaz, C., Ucok, O., and Karasu, H.A. (2003). The effects of articaine hydrochloride on wound healing: An experimental study. *J. Oral. Maxillofac. Surg.* **61**, 1467–1470.
- Dontenwill, M., Vonthron, C., Grenney, H., Magnier, C., Heemskerck, F., and Bousquet, P. (1999). Identification of human II receptors and their relationship to alpha 2-adrenoceptors. *Ann. N.Y. Acad. Sci.* **881**, 123–134.
- Dos Santos, M., and Bogan, J.A. (1974). The metabolism of pentobarbitone in sheep. *Res. Vet. Sci.* **17**, 226–230.
- Dostal, M., Benesova, O., Tejkalova, H., and Soukupova, D. (1995). Immune response of adult rats is altered by administration of diazepam in the first postnatal week. *Reprod. Toxicol.* **9**, 115–121.
- Dowdy, E.G., and Kaya, K. (1968). Studies of the mechanism of cardiovascular responses to CI-581. *Anesthesiology* **29**, 931–943.
- Drucker, M., Cardenas, E., Arizti, P., Valenzuela, A., and Gamboa, A. (1998). Experimental studies on the effect of lidocaine on wound healing. *World J. Surg.* **22**, 394–397.
- Duhm, B., Maul, W., Medenwald, H., Patzschke, K., and Wegner, L.A. (1969). Untersuchungen mit radioaktiv markiertem BAY Va 1470 an ratten. *Berl. und Münch. Tierärztl. Wochenschr* **6**, 104–108.
- Dundee, J.W., and Clarke, R.S.J. (1964). Clinical studies of induction agents IX: A comparative study of a new eugenol derivative, FBA.1420, with G.29.505 and standard barbiturates. *Br. J. Anaesth.* **36**, 100–105.
- Durham, R.A., Sawyer, D.C., Keller, W.F., and Wheeler, C.A. (1992). Topical ocular anesthetics in ocular irritancy testing: A review. *Lab. Anim. Sci.* **42**, 535–541.
- Dwyer, S.D., and Meyers, K.M. (1986). Anesthetics and anticoagulants used in the preparation of rat platelet-rich-plasma alter rat platelet aggregation. *Thromb. Res.* **42**, 139–151.
- Dyson, D., and Pettifer, G. (1997). Evaluation of the arrhythmogenicity of a low dose of acepromazine: Comparison with xylazine. *Can. J. Vet. Res.* **61**, 241–245.
- Eidelman, A., Weiss, J.M., Lau, J., and Carr, D.B. (2005). Topical anesthetics for dermal instrumentation: A systematic review of randomized, controlled trials. *Ann. Emerg. Med.* **46**, 343–351.
- Elfving, B., Bjornholm, B., and Knudsen, G.M. (2003). Interference of anaesthetics with radioligand binding in neuroreceptor studies. *Eur. J. Nucl. Med. Mol. Imaging* **30**, 912–915. Epub 2003 April 25.
- Elmer, M., Eskildsen, P.C., Kristensen, L.O., and Leyssac, P.P. (1972). A comparison of renal function in rats anesthetized with Inactin and sodium amylal. *Acta. Physiol. Scand.* **86**, 41–58.
- England, G.C., and Clarke, K.W. (1996). Alpha 2 adrenoceptor agonists in the horse: A review. *Br. Vet. J.* **152**, 641–657.
- Erhardt, W., Hebestedt, A., Aschenbrenner, G., Pichtok, B., and Blümel, G. (1984). A comparative study with various anesthetics in mice (pentobarbitone, ketamine–xylazine, carfentanyl–etomidate). *Res. Exp. Med. (Berl.)* **184**, 159–169.
- Eriksson, A.S., Sinclair, R., Cassuto, J., and Thomsen, P. (1992). Influence of lidocaine on leukocyte function in the surgical wound. *Anesthesiology* **77**, 74–78.
- Erkert, R.S., and MacAllister, C.G. (2005). Use of a eutectic mixture of lidocaine 2.5% and prilocaine 2.5% as a local anesthetic in animals. *J. Am. Vet. Med. Assoc.* **226**, 1990–1992.
- Eroglu, E., Eroglu, F., Algal, F., Altuntas, I., Sutcu, R., and Ozbasar, D. (2001). The effect of lidocaine/prilocaine cream on an experimental wound healing model. *Eur. J. Emerg. Med.* **8**, 199–201.
- Faber, J.E. (1989). Effects of althesin and urethane-chloralose on neurohumoral cardiovascular regulation. *Am. J. Physiol.* **256**, R757–R765.
- Ferre, P.J., Pasloske, K., Whittam, T., Ranasinghe, M.G., and Lefebvre, H.P. (2006). Plasma pharmacokinetics of alfaxalone in dogs after an intravenous bolus of Alfaxan-CD RTU. *Vet. Anaesth. Anal.* **33**, 229–236.

- Ferrer-Allado, T., Brechner, V.L., Dymond, A., Cozen, H., and Crandall, P. (1973). Ketamine-induced electroconvulsive phenomena in the human limbic and thalamic regions. *Anesthesiology* **38**, 333–344.
- Field, K.J., and Lang, C.M. (1988). Hazards of urethane (ethyl carbamate): A review of the literature. *Lab. Anim.* **22**, 255–262.
- Field, K.J., White, W.J., and Lang, C.M. (1993). Anaesthetic effects of chloral hydrate, pentobarbitone and urethane in adult male rats. *Lab. Anim.* **27**, 258–269.
- File, S.E., and Simmonds, M.A. (1988). Myoclonic seizures in the mouse induced by alphaxalone and related steroid anaesthetics. *J. Pharm. Pharmacol.* **40**, 57–59.
- Fish, R.E. (1997). In "Anesthesia and Analgesia in Laboratory Animals." (D.F. Kohn, S.K. Wixson, W.J. White, and G.J. Benson, eds.), pp 1–28. Academic Press, San Diego, CA.
- Flecknell, P. (1996). "Laboratory Animal Anaesthesia," 2nd ed. Academic Press, San Diego, CA.
- Flecknell, P.A. (1987). "Laboratory Animal Anaesthesia." Academic Press, San Diego, CA.
- Flecknell, P.A., John, M., Mitchell, M., Shurey, C., and Simpkin, S. (1983). Neuroleptanalgesia in the rabbit. *Lab. Anim.* **17**, 104–109.
- Flecknell, P.A., Liles, J.H., and Williamson, H.A. (1990). The use of lignocaine-prilocaine local anaesthetic cream for pain-free venepuncture in laboratory animals. *Lab. Anim.* **24**, 142–146.
- Flecknell, P.A., Liles, J.H., and Wootton, R. (1989). Reversal of fentanyl/fluanisone neuroleptanalgesia in the rabbit using mixed agonist/antagonist opioids. *Lab. Anim.* **23**, 147–155.
- Flecknell, P.A., and Mitchell, M. (1984). Midazolam and fentanyl-fluanisone: Assessment of anaesthetic effects in laboratory rodents and rabbits. *Lab. Anim.* **18**, 143–146.
- Fleischman, R.W., McCracken, D., and Forbes, W. (1977). Adynamic ileus in the rat induced by chloral hydrate. *Lab. Anim. Sci.* **27**, 238–243.
- Fluckiger, J.-P., Sonnay, M., Boillat, N., and Atkinson, J. (1985). Attenuation of the baroreceptor reflex by general anaesthetic agents in the normotensive rat. *Eur. J. Pharmacol.* **109**, 105–109.
- Flynn, A.J., Dengerink, H.A., and Wright, J.W. (1988). Blood pressure in resting, anesthetized and noise-exposed guinea pigs. *Hear. Res.* **34**, 201–206.
- Folle, L.E., and Levesque, R.I. (1976). Circulatory, respiratory and acid-base balance changes produced by anesthetics in the rat. *Acta Biol. Med. Ger.* **35**, 605–612.
- Frankl, W.S., and Poole-Wilson, P.A. (1981). Effects of thiopental on tension development, action potential, and exchange of calcium and potassium in rabbit ventricular myocardium. *J. Cardiovasc. Pharmacol.* **3**, 554–565.
- Fransson, B.A., Peck, K.E., Smith, J.K., Anthony, J.A., and Mealey, K.L. (2002). Transdermal absorption of a liposome-encapsulated formulation of lidocaine following topical administration in cats. *Am. J. Vet. Res.* **63**, 1309–1312.
- Freudenthal, R.I., and Carroll, F.I. (1973). Metabolism of certain commonly used barbiturates. *Drug Metab. Rev.* **2**, 265–278.
- Friedman, J.J. (1959). Effect of Nembutal on circulating and tissue blood volumes and hematocrits of intact and splenectomized mice. *Am. J. Physiol.* **197**, 399–402.
- Frolich, M.A., Price, D.D., Robinson, M.E., Shuster, J.J., Theriaque, D.W., and Heft, M.W. (2005). The effect of propofol on thermal pain perception. *Anesth. Analg.* **100**, 481–486.
- Furuyama, F., Ishida, Y., Furuyama, M., Hashitani, T., Isobe, Y., Sato, H., Ohara, K., and Nishino, H. (1989). Thermal salivation in rats anesthetized with barbiturates, chloralose, urethane and ketamine. *Comp. Biochem. Physiol.* **94C**, 133–138.
- Gaertner, D.J., Boschert, K.R., and Schoeb, T.R. (1987). Muscle necrosis in Syrian hamsters resulting from intramuscular injections of ketamine and xylazine. *Lab. Anim. Sci.* **37**, 80–83.
- Ganayem, B.I. (2007). Inhibition of urethane-induced carcinogenicity in *Cyp2e1*^{-/-} in comparison to *Cyp2e1*^{+/+} mice. *Toxicol. Sci.* **95**, 331–339.
- Garcia-Villar, R., Toutain, P.L., Alvinerie, M., and Ruckebush, Y. (1981). The pharmacokinetics of xylazine hydrochloride: An interspecific study. *J. Vet. Pharmacol. Ther.* **4**, 87–92.
- Gardner, D.J., Davis, J.A., Weina, P.J., and Theune, B. (1995). Comparison of tribromoethanol, ketamine/acetylpromazine, Telazol/xylazine, pentobarbital, and methoxyflurane anesthesia in HSD:ICR mice. *Lab. Anim. Sci.* **45**, 199–204.
- Garmer, N.L. (1969). Effects of 2-ethylamino-2-(2-thienyl) cyclohexanone HCl (CI-634) in cats. *Res. Vet. Sci.* **10**, 382–388.
- Garrett, K., and Gan, J. (1998). Enhancement of gamma-aminobutyric acid-A receptor activity by alpha-chloralose. *J. Pharmacol. Exp. Ther.* **285**, 680–686.
- Gaumann, D.M., and Yaksh, T.L. (1990). Alpha-chloralose anesthesia inhibits the somato-sympathetic reflex response in cats more effectively than halothane. *J. Vet. Med.* **37**, 669–675.
- Gaynor, J.S., and Mama, K.R. (2002). Local and regional anesthetic techniques for alleviation of perioperative pain. In: "Handbook of Veterinary Pain Management." (J.S. Gaynor and W.W. Muir III, eds.), pp 261–280, Mosby, St. Louis, MO.
- Gilron, I., and Coderre, T.J. (1996). Preemptive analgesic effects of steroid anesthesia with alphaxalone in the rat formalin test. Evidence for differential GABA(A) receptor modulation in persistent nociception. *Anesthesiology* **84**, 572–579.
- Gin, T., Yau, G., Jong, W., Tan, P., Leung, R.K., and Chan, K. (1991). Disposition of propofol at caesarean section and in the postpartum period. *Br. J. Anaesth.* **67**, 49–53.
- Glen, J.B. (1980). Animal studies of the anaesthetic activity of ICI 35 868. *Br. J. Anaesth.* **52**, 731–742.
- Glen, J.B., and Hunter, S.C. (1984). Pharmacology of an emulsion formulation of ICI 35 868. *Br. J. Anaesth.* **56**, 617–625.
- Goelz, M.F. (1994). Anesthetic and pathologic effects of tribromoethanol in mice. Toxicology Bibliographic Information (Toxline), Document Number CRISP/95/S22112-02 <http://toxnet.nlm.nih.gov>.
- Gopalan, C., Hegade, G.M., Bay, T.N., Brown, S.R., and Talcott, M.R. (2005). Tribromoethanol-medetomidine combination provides a safe and reversible anesthetic effect in Sprague-Dawley rats. *Contemp. Top. Lab. Anim. Sci.* **44**, 7–10.
- Grant, R.L., and Acosta, D. (1994). Comparative toxicity of tetracaine, proparacaine and cocaine evaluated with primary cultures of rabbit corneal epithelial cells. *Exp. Eye Res.* **58**, 469–478.
- Green, C.J. (1979). "Animal Anaesthesia: Laboratory Animal Handbooks 8." Laboratory Animals Ltd., London.
- Green, C.J., Knight, J., Precious, S., and Simpkin, S. (1981). Metomidate, etomidate and fentanyl as injectable anaesthetic agents in mice. *Lab. Anim.* **15**, 171–175.
- Greene, M.J. (1972). Some aspects of the pharmacology of droperidol. *Br. J. Anaesth.* **44**, 1272–1276.
- Greene, S.A., and Thurmon, J.C. (1988). Xylazine—A review of its pharmacology and use in veterinary medicine. *J. Vet. Pharmacol. Ther.* **11**, 295–313.
- Grubb, T.L., Riebold, T.W., and Huber, M.J. (1992). Comparison of lidocaine, xylazine, and xylazine/lidocaine for caudal epidural analgesia in horses. *J. Am. Vet. Med. Assoc.* **201**, 1187–1190.
- Guenette, S.A., Beaudry, F., Marier, J.F., and Vachon, P. (2006). Pharmacokinetics and anesthetic activity of eugenol in male Sprague-Dawley rats. *J. Vet. Pharmacol. Ther.* **29**, 265–270.
- Guenette, S.A., Helie, P., Beaudry, F., and Vachon, P. (2007). Eugenol for anesthesia of African clawed frogs (*Xenopus laevis*). *Vet. Anaesth. Analg.* **34**, 164–170.
- Gumbleton, M. (1989). Anaesthetic influences on brain haemodynamics in the rat and their significance to biochemical, neuropharmacological and drug disposition studies. *Biochem. Pharmacol.* **38**, 2745–2748.
- Gumbleton, M., and Benet, L.Z. (1991). Drug metabolism and laboratory anesthetic protocols in the rat: Examination of antipyrine pharmacokinetics. *Pharm. Res.* **8**, 544–546.

- Gumbleton, M., Nicholls, P.J., and Taylor, G. (1988). The renin-angiotensin system and intraperitoneal toxicity: Possible basis to urethane anaesthesia-induced reductions in renal clearance in the rat. *Arch. Int. Pharmacodyn.* **294**, 7–32.
- Gumbleton, M., Nicholls, P.J., and Taylor, G. (1990a). Differential influence of laboratory anaesthetic regimens upon renal and hepatosplanchnic haemodynamics in the rat. *J. Pharm. Pharmacol.* **42**, 693–697.
- Gumbleton, M., Nicholls, P.J., and Taylor, G. (1990b). Differential effects of anaesthetic regimens on gentamicin pharmacokinetics in the rat: A comparison with chronically catheterized conscious animals. *Pharm. Res.* **7**, 41–45.
- Haberle, D.A., Davis, J.M., Kawabata, M., Metz, C., Wapler, P., and Stachl, M. (1993). Renal and single-nephron function is comparable in thiobutabarbitione- and thiopentone-anaesthetised rats. *Pflugers Arch.* **424**(3–4), 224–230.
- Hagino, N. (1979). Effect of Nembutal on LH release in baboons. *Horm. Metab. Res.* **11**, 296–300.
- Hall, C.E., Ayachi, S., and Hall, O. (1976). Differential sensitivity of spontaneously hypertensive (SHR) and control rats to various anaesthetic agents. *Clin. Exp. Pharmacol. Physiol.* **3**, 83–86.
- Hall, J.G., and Morris, B. (1962). The output of cells in lymph from the popliteal node of sheep. *J. Exp. Physiol.* **47**, 360–369.
- Hall, L.W., and Clarke, K.W. (1991a). Principles of sedation, analgesia, and premedication. In “Veterinary Anesthesia,” 9th ed., pp 51–79. Bailliere Tindall, London.
- Hall, L.W., and Clarke, K.W. (1991b). General principles of local analgesia. In “Veterinary Anesthesia,” 9th ed., pp 173–188. Bailliere Tindall, London.
- Hall, L.W., Clarke, K.W., and Trim, C.M. (2001). General pharmacology of the injectable agents in anaesthesia. In “Veterinary Anesthesia,” 10th ed., pp 75–91, 113–132. W. B Saunders, London.
- Hall, R., and Murdoch, J. (1990). Brain protection: Physiological and pharmacological considerations. Part II: The pharmacology of brain protection. *Can. J. Anaesth.* **37**, 762–777.
- Hammer, R., Dahlgren, C., and Stendahl, O. (1985). Inhibition of human leukocyte metabolism and random mobility by local anaesthesia. *Acta Anaesthesiol. Scand.* **29**, 520–523.
- Hamstra, W.N., Doray, D., and Dunn, J.D. (1984). The effect of urethane on pituitary-adrenal function of female rats. *Acta Endocrinol.* **106**, 362–367.
- Hansen, M.K., Nymoen, U., and Horsberg, T.E. (2003). Pharmacokinetic and pharmacodynamic properties of metomidate in turbot (*Scophthalmus maximus*) and halibut (*Hippoglossus hippoglossus*). *J. Vet. Pharmacol. Ther.* **26**, 95–103.
- Hara, K., and Harris, R.A. (2002). The anesthetic mechanism of urethane: The effects on neurotransmitter-gated ion channels. *Anesth. Analg.* **94**, 313–318.
- Hardman, J.G., Limbird, L.E., Molinoff, P.B., Ruddon, R.W., Gilman, A.G. (eds.). (1996). “Goodman and Gilman’s The Pharmacological Basis of Therapeutics,” 9th ed. McGraw-Hill, New York.
- Hart, C.Y., Burnett, J.C., Jr., and Redfield, M.M. (2001). Effects of avertin versus xylazine–ketamine anesthesia on cardiac function in normal mice. *Am. J. Physiol. Heart Circ. Physiol.* **281**, H1938–H1945.
- Haskins, S.C. (1992). Injectable anesthetics. *Vet. Clin. North Am. Small Anim. Pract.* **22**, 245–260.
- Haspel, H.C., Stephenson, K.N., Davies-Hill, T., El-Barbary, A., Lobo, J.F., Croxen, R.L., Mougrabi, W., Koehler-Stec, E.M., Fenstermacher, J.D., and Simpson, I.A. (1999). Effects of barbiturates on facilitative glucose transporters are pharmacologically specific and isoform selective. *J. Membr. Biol.* **169**, 45–53.
- Hatch, R.C. (1966). The effect of glucose, sodium lactate, and epinephrine on thiopental anesthesia in dogs. *J. Am. Vet. Med. Assoc.* **148**, 135–140.
- Hatch, R.C. (1973). Experiments on antagonism of barbiturate anesthesia with adrenergic, serotonergic, and cholinergic stimulants given alone and in combination. *Am. J. Vet. Res.* **34**, 1321–1331.
- Hatch, R.C., Kitzman, J.V., Zahner, J.M., and Clark, J.D. (1984). Comparison of five preanesthetic medicaments in thiopental-anesthetized cats: Antagonism by selected compounds. *Am. J. Vet. Res.* **45**, 2322–2327.
- Haws, J.L., Herman, N., Clark, Y., Bjoraker, R., and Jones, D. (1998). The chemical stability and sterility of sodium thiopental after preparation. *Anesth. Analg.* **86**, 208–213.
- Hayashi, Y., Sumikawa, K., Yamatodani, A., Tashiro, C., Wada, H., and Yoshiya, I. (1989). Myocardial sensitization by thiopental to arrhythmogenic action of epinephrine in dogs. *Anesthesiology* **71**, 929–935.
- Hayes, M.A., Hartup, B.K., Pittman, J.M., and Barzen, J.A. (2003). Capture of sandhill cranes using alpha-chloralose. *J. Wildl. Dis.* **39**, 859–868.
- Heaton, J.T., and Brauth, S.E. (1991). Effects of yohimbine as a reversing agent for ketamine–xylazine anesthesia in budgerigars. *Lab. Anim. Sci.* **42**, 54–56.
- Heavner, J.E. (1986). Anesthesia, analgesia, and restraint. In “Methods of Animal Experimentation.” (W.I. Gay and J.E. Heavner, eds.), Vol. VII, Part A, pp 1–35. Academic Press, Orlando, FL.
- Heavner, J.E. and Bowen, J.M. (1968). Influence of adrenergic agents on recovery of dogs from anesthesia. *Am. J. Vet. Res.* **29**, 2133–2139.
- Hedenqvist, P., and Hellebrekers, L.J. (2003). Laboratory animal analgesia, anesthesia, and euthanasia. In “Handbook of Laboratory Animal Science, Vol. 1: Essential Principles and Practices.” (J. Hau, G.L. Van Hoosier, Jr., eds.), pp 413–455. CRS Press, FL.
- Heldmann, E., Brown, D.C., and Shofer, F. (1999). The association of propofol usage with postoperative wound infection rate in clean wounds: A retrospective study. *Vet. Surg.* **28**, 256–259.
- Hernandez, D.E., Meyer, R.E., Irving, P.E., and Crane, S.W. (1987). Reversal of pentobarbital-induced narcosis by thyrotropin-releasing hormone (TRH) in dogs. *Pharmacol. Res. Commun.* **19**, 567–577.
- Heykants, J., Pardoel, L., and Janssen, P.A.J. (1971). On the distribution and metabolism of azaperone (R 1929) in the rat and pig. Part I: Excretion and metabolism of azaperone in the Wistar rat. *Drug Res.* **21**, 982–984.
- Heykants, J.P., Meuldermans, W.E.G., Michiels, L.J.M., and Lewi, P.J. (1975). Distribution, metabolism and excretion of etomidate, a short-acting hypnotic drug, in the rat. Comparative study of (R)-(+)- and (S)-(–)-etomidate. *Arch. Int. Pharmacodyn.* **216**, 113–129.
- Heys, S.D., Norton, A.C., Dundas, C.R., Eremin, O., Ferguson, K., and Garlick, P.J. (1989). Anaesthetic agents and their effect on tissue protein synthesis in the rat. *Clin. Sci.* **77**, 651–655.
- Higashi, Y., Notoji, N., Yamajo, R., and Yata, N. (1982). Effect of anesthesia on drug disposition in the rat. *J. Pharm. Dyn.* **5**, 112–119.
- Hill, J.V., and Forster, M.E. (2004). Cardiovascular responses of Chinook salmon (*Oncorhynchus tshawytscha*) during rapid anaesthetic induction and recovery. *Comp. Biochem. Physiol. C Toxicol. Pharmacol.* **137**, 167–177.
- Hillebrand, A., Meer, C. van der, Ariens, A.T., and Wijnans, M. (1971). The effect of anesthetics on the occurrence of kidney lesions caused by hypotension. *Eur. J. Pharmacol.* **14**, 217–237.
- Himmelseher, S., and Durieux, M.E. (2005). Revising a dogma: Ketamine for patients with neurological injury? *Anesth. Analg.* **101**, 524–534.
- Hinton, B.T. (1982). Hyperglycemia in urethane-anesthetized rats: Involvement of the adrenal gland. *Lab. Anim. Sci.* **32**, 251–252.
- Hirshman, C.A., Downes, H., Farbood, A., and Bergman, N.A. (1979). Ketamine block of bronchospasm in experimental canine asthma. *Br. J. Anaesth.* **51**, 713–718.
- Hirshman, C.A., McCullough, R.E., Cohen, P.J., and Weil, J.V. (1975). Hypoxic ventilatory drive in dogs during thiopental, ketamine, or pentobarbital anesthesia. *Anesthesiology* **43**, 628–634.
- Hobbs, B.A., Rolhall, T.G., Sprengel, T.L., and Anthony, K.L. (1991). Comparison of several combinations for anesthesia in rabbits. *Am. J. Vet. Res.* **52**, 669–674.
- Hoffler, U., El-Masri, H.A., and Ghanayem, B.I. (2003). Cytochrome P450 2E1 (CYP2E1) is the principal enzyme responsible for urethane metabolism: Comparative studies using CYP2E1-null and wild-type mice. *J. Pharm. Exp. Ther.* **305**, 557–564.
- Hogan, B., Beddington, R., Costantini, F., and Lacy, E. (1996). “Manipulating the Mouse Embryo.” Cold Spring Harbor Laboratory, New York.

- Hogan, B., Costantini, F., and Lacy, E. (1986). "Manipulating the Mouse Embryo A Laboratory Manual," pp 132, 137, 143, 271. Cold Spring Harbor Laboratory, New York.
- Holck, H.G.O., Kanån, M.A., Mills, L.M., and Smith, E.L. (1937). Studies upon the sex-difference in rats in tolerance to certain barbiturates and to nicotine. *J. Pharmacol. Exp. Ther.* **60**, 323–346.
- Holzgreffe, H.H., Everitt, J.M., and Wright, E.M. (1987). Alpha-chloralose as a canine anesthetic. *Lab. Anim. Sci.* **37**, 587–595.
- Hosoi, E., Saito, H., Yamasaki, R., Kimura, S., and Saito, S. (1988). Influence of anesthetic agents on the release of growth hormone induced by growth hormone-releasing hormone in rats. *Tokushima J. Exp. Med.* **35**, 85–90.
- Hrapkiewicz, K.L., Stein, S., and Smiler, K.L. (1989). A new anesthetic agent for use in the gerbil. *Lab. Anim. Sci.* **9**, 338–341.
- Hsu, W.H. (1982). Xylazine-induced delay of small intestinal transit in mice. *Eur. J. Pharmacol.* **83**, 55–60.
- Hsu, W.H. (1992). Antagonism of pharmacologic effects of xylazine. In "Animal Pain." (C.E. Short and A. Van Poznak, eds.), pp 225–236. Churchill Livingstone, New York.
- Hsu, W.H., Bellin, S.I., Dellmann, H.-D., and Hanson, C.E. (1986). Xylazine-ketamine-induced anesthesia in rats and its antagonism by yohimbine. *J. Am. Vet. Med. Assoc.* **189**, 1040–1043.
- Hsu, W.H., and Hembrough, F.B. (1982). Intravenous glucose tolerance test in cats: Influenced by acetylpromazine, ketamine, morphine, thiopental, and xylazine. *Am. J. Vet. Res.* **43**, 2060–2061.
- Hsu, W.H., and Hummel, S.K. (1981). Xylazine-induced hyperglycemia in cattle: A possible involvement of alpha 2-adrenergic receptors regulating insulin release. *Endocrinology* **109**, 825–829.
- Hu, C., Flecknell, P.A., and Liles, J.H. (1992). Fentanyl and medetomidine anaesthesia in the rat and its reversal using atipamazole and either nalbuphine or butorphanol. *Lab. Anim.* **26**, 15–22.
- Huang, L.Y., and Barker, J.L. (1980). Pentobarbital: Stereospecific actions of (+) and (–) isomers revealed on cultured mammalian neurons. *Science* **207**, 195–197.
- Hughes, M.A., Glass, P.S., and Jacobs, J.R. (1992). Context-sensitive half-time in multicompartment pharmacokinetic models for intravenous anesthetic drugs. *Anesthesiology* **76**, 334–341.
- Hunter, W.S., Holmes, K.R., and Elizondo, R.S. (1981). Thermal balance in ketamine-anesthetized rhesus monkey *Macaca mulatta*. *Am. J. Physiol.* **241**, R301–R306.
- IASP Task Force on Taxonomy. (1994). "Classification of Chronic Pain." (H. Merskey and N. Bogduk, eds.), pp 209–214. IASP Press, Seattle, WA.
- Isvall, J., Aronsen, K.F., and Stenberg, P. (1980). Tissue perfusion and distribution of cardiac output during ketamine anesthesia in normovolemic rats. *Acta Anaesth. Scand.* **24**, 257–263.
- Ikbali, M., Tastekin, A., Dogan, H., Pirim, I., and Ors, R. (2004). The assessment of genotoxic effects in lymphocyte cultures of infants treated with chloral hydrate. *Mutat. Res. Genet. Toxicol. Environ. Mutagen.* **564**, 159–164.
- Ikuta, P.T., Raza, S.M., Durrani, Z., Vasireddy, A.R., Winnie, A.P., and Masters, R.W. (1989). pH adjustment schedule for the amide local anesthetics. *Reg. Anesth.* **14**, 229–235.
- Ilkiw, J.E. (1992). Advantages and guidelines for using ultrashort barbiturates for induction of anesthesia. *Vet. Clin. North Am. Small Anim. Pract.* **22**, 261–265.
- Ilkiw, J.E., Benthuyens, J.A., Ebling, W.F., and McNeal, D. (1991). A comparative study of the pharmacokinetics of thiopental in the rabbit, sheep and dog. *J. Vet. Pharmacol. Ther.* **14**, 134–140.
- Ilkiw, J.E., Farver, T.B., Suter, C., McNeal, D., and Steffey, E.P. (2002). The effect of intravenous administration of variable-dose flumazenil after fixed-dose ketamine and midazolam in healthy cats. *J. Vet. Pharmacol. Ther.* **25**, 181–188.
- Ilkiw, J.E., and Pascoe, P.J. (2003). Cardiovascular effects of propofol alone and in combination with ketamine for total intravenous anesthesia in cats. *Am. J. Vet. Res.* **64**, 913–917.
- Ilkiw, J.E., Pascoe, P.J., Haskins, S.C., and Patz, J.D. (1992). Cardiovascular and respiratory effects of propofol administration in hypovolemic dogs. *Am. J. Vet. Res.* **12**, 2323–2327.
- Im, W.B., Blakeman, D.P., Davis, J.P., and Ayer, D.E. (1990). Studies on the mechanism of interactions between anesthetic steroids and g-aminobutyric acidA receptors. *Mol. Pharmacol.* **37**, 429–434.
- Inai, K., Arihiro, K., Takeshima, Y., Yonehara S., Tachiyama, Y., Khatun, N., and Nishisaka, T. (1991). Quantitative risk assessment of carcinogenicity of urethane (ethyl carbamate) on the basis of long-term oral administration to B6C3F1 mice. *Jpn. J. Cancer Res.* **82**, 380–385.
- Ingvast-Larsson, J.C., Axen, V.C., and Kiessling, A.K. (2003). Effects of isoeugenol on in vitro neuromuscular blockade of rat phrenic nerve-diaphragm preparations. *Am. J. Vet. Res.* **64**, 690–693.
- Ishikawa, N., Kallman, C.H., and Sagawa, K. (1984). Rabbit carotid sinus reflex under pentobarbital, urethane, and chloralose anesthesia. *Am. J. Physiol.* **246**, H696–H701.
- Ishizuka, S., Sikdar, S.K., Yasui, S., Oyama, Y., and Akaike, N. (1989). a-chloralose opens the chloride channel of frog isolated sensory neurons. *Brain Res.* **498**, 181–184.
- Iversen, O.H. (1991). Urethane (ethyl carbamate) is an effective promoter of 7, 12-dimethylbenz[a]anthracene-induced carcinogenesis in mouse skin two-stage experiments. *Carcinogenesis* **12**, 901–903.
- Jager, L.P., De Graaf, G.J., and Widjaja-Greefkes, H.C. (1998). Effects of atipamezole, detomidine and medetomidine on release of steroid hormones by porcine adrenocortical cells in vitro. *Eur. J. Pharmacol.* **346**, 71–76.
- Janssen, B.J., De Celle, T., Debets, J.J., Brouns, A.E., Callahan, M.F., and Smith, T.L. (2004). Effects of anesthetics on systemic hemodynamics in mice. *Am. J. Physiol. Heart Circ. Physiol.* **287**, H1618–H1624. Epub May 20.
- Janssen, G.H., Tangelder, G.J., oude Egbrink, M.G., and Reneman, R.S. (1997). Different effects of anesthetics on spontaneous leukocyte rolling in rat skin. *Int. J. Microcirc. Clin. Exp.* **17**, 305–313.
- Jewett, B.A., Gibbs, L.M., Tarasiuk, A., and Kendig, J.J. (1992). Propofol and barbiturate depression of spinal nociceptive neurotransmission. *Anesthesiology* **77**, 1148–1154.
- Jinnouchi, A., Aida, Y., Nozoe, K., Maeda, K., and Pabst, M.J. (2005). Local anesthetics inhibit priming of neutrophils by lipopolysaccharide for enhanced release of superoxide: Suppression of cytochrome b558 expression by disparate mechanisms. *J. Leukoc. Biol.* **78**, 1356–1365. Epub 2005 October 4.
- Johansen, O., Vaaler, S., Jorde, R., and Reikeras, O. (1993). Increased plasma glucose levels after hypnorm anaesthesia, but not after pentobarbital anaesthesia in rats. *Lab. Anim.* **28**, 244–248.
- Johnson, K.B., Egan, T.D., Layman, J., Kern, S.E., White, J.L., and McJames, S.W. (2003). The influence of hemorrhagic shock on etomidate: A pharmacokinetic and pharmacodynamic analysis. *Anesth. Analg.* **96**, 1360–1368.
- Johnson, R., Fowler, J.F., and Zanelli, G.D. (1976). Changes in mouse blood pressure, tumor blood flow, and core and tumor temperatures following Nembutal or urethane anesthesia. *Radiology* **118**, 697–703.
- Jondorff, W.R., Maickel, R.P., and Brodie, B.B. (1958). Inability of newborn mice and guinea pigs to metabolize drugs. *Biochem. Pharmacol.* **1**, 352–354.
- Jones, D.J., Stehling, L.C., and Zauder, H.L. (1979). Cardiovascular responses to diazepam and medazolam maleate in the dog. *Anesthesiology* **51**, 430–434.
- Jones, R.S. (1985). Steroid anaesthetics. *Proc. 2nd Intl. Cong. Vet. Anes.* 15–17.
- Jong, W.M., Zuurbier, C.J., De Winter, R.J., Van Den Heuvel, D.A., Reitsma, P.H., Ten Cate, H., and Ince, C. (2002). Fentanyl-fluanisone-midazolam combination results in more stable hemodynamics than does urethane alpha-chloralose and 2,2,2-tribromoethanol in mice. *Contemp. Top. Lab. Anim. Sci.* **41**, 28–32.
- Judge, A.J., Najafi, K., Lee, D.A., and Miller, K.M. (1997). Corneal endothelial toxicity of topical anesthesia. *Ophthalmology* **104**, 1373–1379.
- Kao, L.W., Kirk, M.A., Evers, S.J., and Rosenfeld, S.H. (2003). Droperidol, QT prolongation, and sudden death: What is the evidence? *Ann. Emerg. Med.* **41**, 546–558.
- Kastner, S.B. (2006). A2-agonists in sheep: A review. *Vet. Anaesth. Analg.* **33**, 79–96.

- Kaufman, M.H. (1975). Parthenogenetic activation of mouse oocytes following Avertin anaesthesia. *J. Embryol. Exp. Morphol.* **8**, 941–946.
- Kaufman, M.H. (1977). Effect of anaesthesia on the outcome of pregnancy in female mice. *J. Reprod. Fertil.* **49**, 167–168.
- Kawai, N., Keep, R.F., and Betz, A.L. (1997). Hyperglycemia and the vascular effects of cerebral ischemia. *Stroke* **28**, 149–154.
- Kawaue, Y., and Iriuchijima, J. (1984). Changes in cardiac output and peripheral flows on pentobarbital anesthesia in the rat. *Jpn. J. Physiol.* **34**, 283–294.
- Kazerani, H.R., and Furman, B.L. (2006). Comparison of urethane/chloralose and pentobarbitone anaesthesia for examining effects of bacterial lipopolysaccharide in mice. *Fundam. Clin. Pharmacol.* **20**, 379–384.
- Keates, H. (2003). Induction of anaesthesia in pigs using a new alphaxalone formulation. *Vet. Record.* **153**, 627–628.
- Keene, J.L., Noakes, D.L., Moccia, R.D., et al. (1998). The efficacy of clove oil as an anaesthetic for rainbow trout, *Oncorhynchus mykiss* (Walbaum). *Aquaculture Res.* **29**, 89–101.
- Kelbel, I., Koch, T., Weber, A., Schiefer, H.G., van Ackern, K., and Neuhofer, H. (1999). Alterations of bacterial clearance induced by propofol. *Acta Anaesthesiol. Scand.* **43**, 71–76.
- Kelland, M.D., Chiodo, L.A., and Freeman, A.S. (1990). Anesthetic influences on the basal activity and pharmacological responsiveness of nigrostriatal dopamine neurons. *Synapse* **6**, 207–209.
- Kintz, K., Jamey, C., and Mangin, P. (1996). Trichloroethanol is not a metabolite of alpha chloralose. *Int. J. Leg. Med.* **108**, 191–193.
- Klaassen, C.D. (1971). Biliary excretion of barbiturates. *Br. J. Pharmacol.* **43**, 161–166.
- Klide, A.M. (1992). Anatomy of the spinal cord and how the spinal cord is affected by local anesthetics and other drugs. *Vet. Clin. North Am. Small Anim. Pract.* **22**, 413–416.
- Klotz, U., Antonin, K.-H., and Bieck, P.R. (1976). Pharmacokinetics and plasma binding of diazepam in man, dog, rabbit, guinea pig and rat. *J. Pharmacol. Exp. Ther.* **199**, 67–73.
- Ko, J.C., Williams, B.L., Rogers, E.R., Pablo, L.S., McCaine, W.C., and McGrath, C.J. (1995). Increasing xylazine dose-enhanced anesthetic properties of telazol-xylazine combination in swine. *Lab. Anim. Sci.* **45**, 290–294.
- Ko, J.C.H., Thurmon, J.C., Tranquilli, W.J., Benson, G.J., and Olson, W.A. (1992). A comparison of medetomidine-propofol and medetomidine-midazolam-propofol anesthesia in rabbits. *Lab. Anim. Sci.* **42**, 503–507.
- Kochhar, M.M., Aykac, I., Davidson, P.P., and Fraley, E.D. (1986). Teratologic effects of D, 1-2-(*o*-chlorophenyl)-2-(methylamino) cyclohexanone hydrochloride (ketamine hydrochloride) in rats. *Res. Commun. Chem. Pathol. Pharmacol.* **54**, 413–416.
- Kohro, S., Hogan, Q.H., Nakae, Y., Yamakage, M., and Bosnjak, Z.J. (2001). Anesthetic effects on mitochondrial ATP-sensitive K channel. *Anesthesiology* **95**, 1435–1440.
- Kohrs, R., and Durieux, M.E. (1998). Ketamine: Teaching an old drug new tricks. *Anesth. Analg.* **87**, 1186–1193.
- Koizumi, T., Maeda, H., and Hioki, K. (2002). Sleep-time variation for ethanol and the hypnotic drugs tribromoethanol, urethane, pentobarbital, and propofol within outbred ICR mice. *Exp. Anim.* **51**, 119–124.
- Kona-Boun, J.J., Cuveliez, S., and Troncy, E.J. (2006). Evaluation of epidural administration of morphine or morphine and bupivacaine for postoperative analgesia after premedication with an opioid analgesic and orthopedic surgery in dogs. *Am. Vet. Med. Assoc.* **229**, 1103–1112.
- Krasowski, M.D., and Harrison, N.L. (2000). The actions of ether, alcohol and alkane general anaesthetics on GABA-A and glycine receptors and the effects of TM2 and TM3 mutations. *Br. J. Pharmacol.* **129**, 731–743.
- Kumar, A., Mann, H.J., and Rimmel, R.P. (2006). Pharmacokinetics of tiletamine and zolazepam (Telazol) in anesthetized pigs. *J. Vet. Pharmacol. Ther.* **29**, 587–589.
- Kumar, R., and Kumar, A. (1984). Ketamine with and without premedication in rats and rabbits. *Ind. Vet. J.* **61**, 372–376.
- Kurata, N., Hurst, H.E., Benz, F.W., Kemper, R.A., and Waddell, W.J. (1991). Studies on inhibition and induction of metabolism of ethyl carbamate by acetone and related compounds. *Drug Metab. Dispos.* **19**, 388–393.
- Kurz, H., and Fichtl, B. (1981). Interrelation between plasma protein binding, rate of injection and the anaesthetic effect of thiopental. *Biopharm. Drug Dispos.* **2**, 191–196.
- Kuusela, E., Raekallio M., Anttila, M., Falck, I., Molsa, S., and Vainio, O. (2000). Clinical effects and pharmacokinetics of medetomidine and its enantiomers in dogs. *J. Vet. Pharmacol. Ther.* **23**, 15–20.
- Kyles, A.E., Waterman, A.E., and Livingston A. (1993). Antinociceptive effects of combining low doses of neuroleptic drugs and fentanyl in sheep. *Am. J. Vet. Res.* **54**, 1483–1488.
- Lacoste, L., Bouquet, S., Ingrand, P., Caritez, J.C., Carretier, M., and Debaene, B. (2000). Intranasal midazolam in piglets: Pharmacodynamics (0.2 vs. 0.4 mg/kg) and pharmacokinetics (0.4mg/kg) with bioavailability determination. *Lab. Anim.* **34**, 29–35.
- Lafortune, M., Mitchell, M.A., and Smith, J.A. (2001). Evaluation of medetomidine, clove oil, and propofol for anesthesia of leopard frogs, *Rana pipiens*. *J. Herpetol. Med. Surg.* **11**, 13–18.
- Lakhlani, P.P., MacMillan, L.B., Guo, T.Z., McCool, B.A., Lovinger, D.M., Maze, M., and Limbird, L.E. (1997). Substitution of a mutant alpha2-adrenergic receptor via “hit and run” gene targeting reveals the role of this subtype in sedative, analgesic, and anesthetic-sparing responses in vivo. *Proc. Natl. Acad. Sci. U.S.A.* **94**(18), 9950–9955.
- Lammintausta, R., Outi, V., Virtanen, R., and Vähä-Vahe, T. (eds.). (1989). Medetomidine, a novel α_2 -agonist for veterinary sedative and analgesic use. *Acta. Vet. Scand.* **85**(Suppl.), 1–204.
- Lamont, L., and Tranquilli, W. (2002). α_2 -agonists. In “Handbook of Veterinary Pain Management.” (J.S. Gaynor and W.W. Muir III, eds.), pp 199–220, Mosby, St. Louis.
- Lamont, L.A., Bulmer, B.J., Sisson, D.D., Grimm, K.A., and Tranquilli, W.J. (2002). Doppler echocardiographic effects of medetomidine on dynamic left ventricular outflow tract obstruction in cats. *J. Am. Vet. Med. Assoc.* **221**, 1276–1281.
- Lamson, P.D., Greig, M.E., and Williams, L. (1952). Potentiation by epinephrine of the anesthetic effect in chloral and barbiturate anesthesia. *J. Pharmacol. Exp. Ther.* **106**, 219–224.
- Langevin, P.B., Gravenstein, N., Doyle, T.J., Roberts, S.A., Skinner, S., Langevin, S.O., and Gulig, P.A. (1999). Growth of *Staphylococcus aureus* in Diprivan and Intralipid: Implications on the pathogenesis of infections. *Anesthesiology* **91**, 1394–1400.
- Larsson, J.E., Koskinen, L.O., and Wahlstrom, G. (1996). Effects of TRH and atropine on induction and duration of anesthesia with propofol in rats. *Peptides* **17**, 293–297.
- Larsson, J.E., and Wahlstrom, G. (1998). The influence of age and administration rate on the brain sensitivity to propofol in rats. *Acta Anaesthesiol. Scand.* **42**, 987–994.
- Lash, L.H., Fisher, J.W., Lipscomb, J.C. and Parker, J.C. (2000). Metabolism of trichloroethylene. *Environ. Health Perspect.* **108**, 177–200.
- Latt, R.H., and Ecobichon, D.J. (1984). Self-mutilation in guinea pigs following the intramuscular injection of ketamine acepromazine. *Lab. Anim. Sci.* **34**, 516.
- Laurent, Y., Wallemacq, P., Haufroid, V., Renkin, J., Liolios, A., and Hantson, P. (2006). Electrocardiographic changes with segmental akinesia after chloral hydrate overdose. *J. Emerg. Med.* **30**, 179–182.
- Lee, K.C., Wilder, R.T., Smith, R.L., and Berde, C.B. (1994). Thermal hyperalgesia accelerates and MK-801 prevents the development of tachyphylaxis to rat sciatic nerve blockade. *Anesthesiology* **81**, 1284–1293.
- Lee, S.S., Girod, C. Valla, D. Geoffroy, P., and Lebrec, D. (1985). Effects of pentobarbital sodium anesthesia on splanchnic hemodynamics of normal and portal-hypertensive rats. *Am. J. Physiol.* **249**, G528–G532.
- Lee, V.C., Moscicki, J.C., and DiFazio, C.A. (1998). Propofol sedation produces dose-dependent suppression of lidocaine-induced seizures in rats. *Anesth. Analg.* **86**, 652–657.

- Lee-Son, S., Wang, G.K., Concus, A., Crill, E., and Strichartz, G. (1992). Stereoselective inhibition of neuronal sodium channels by local anesthetics. Evidence for two sites of action? *Anesthesiology* **77**, 324–335.
- Lei, H., Grinberg, O., Nwaigwe, C.I., Hou, H.G., Williams, H., Swartz, H.M., and Dunn, J.F. (2001). The effects of ketamine–xylazine anesthesia on cerebral blood flow and oxygenation observed using nuclear magnetic resonance perfusion imaging and electron paramagnetic resonance oximetry. *Brain Res.* **913**, 174–179.
- Leithauser, M.T., Liem, A., Steward, B.C., Miller, E.C., and Miller, J.A. (1990). 1, N6-ethenoadenosine formation, mutagenicity and murine tumor induction as indicators of the generation of an electrophilic epoxide metabolite of the closely related carcinogens ethyl carbamate (urethane) and vinyl carbamate. *Carcinogenesis* **11**, 463–473.
- Lemm, C.A. (1993). "Evaluation of Five Anesthetics on Striped Bass." Resource Publication 196. U.S. Department of the Interior, Fish and Wildlife Service, Washington, DC.
- Lewi, P.J., Heykants, J.J.P., and Janssen, P.A.J. (1976). Intravenous pharmacokinetic profile in rats of etomidate, a short-acting hypnotic drug. *Arch. Int. Pharmacodyn.* **220**, 72–85.
- Lieggi, C.C., Artwohl, J.E., Leszczynski, J.K., Rodriguez, N.A., Fickbohm, B.L., and Fortman, J.D. (2005a). Efficacy and safety of stored and newly prepared tribromoethanol in ICR mice. *Contemp. Top. Lab. Anim. Sci.* **44**, 17–22.
- Lieggi, C.C., Fortman, J.D., Kleps, R.A., Sethi, V., Anderson, J.A., Brown, C.E., and Artwohl, J.E. (2005b). An evaluation of preparation methods and storage conditions of tribromoethanol. *Contemp. Top. Lab. Anim. Sci.* **44**, 11–16.
- Lin, H.C. (1996). Dissociative anesthetics. In "Lumb and Jones' Veterinary Anesthesia." (J.C. Thurmon, W.J. Tranquilli, and G.J. Benson, eds.), 3rd ed., pp 241–296. Lippincott Williams and Wilkins, New York.
- Lin, H.C., Thurmon, J.C., Benson, G.J., and Tranquilli, W.J. (1993). Telazol—A review of its pharmacology and use in veterinary medicine. *J. Vet. Pharmacol. Ther.* **16**, 383–418.
- Lin, M.T., Chen, C.F., and Pang, I.H. (1978). Effect of ketamine on thermoregulation in rats. *Can. J. Physiol. Pharmacol.* **56**, 963–967.
- Lincoln, D.W., Hill, A., and Wakerley, J.B. (1973) The milk ejection reflex in the rat: An intermittent function not abolished by surgical levels of anesthesia. *J. Endocrinol.* **57**, 459–476.
- Lindberg, L.-A. (1986). Sedative and analgesic effects of detomidine in horses and cattle. *Acta Vet. Scand.* **82**(Suppl.), 1–208.
- Lipscomb, J.C., Mahle, D.A., Brashear, W.T., and Garrett, C.M. (1996). A species comparison of choral hydrate metabolism in blood and liver. *Biochem. Biophys. Res. Commun.* **227**, 340–350.
- Liu, P.L., Feldman, H.S., Giasi, R., Patterson, M.K., and Covino, B.G. (1983). Comparative CNS toxicity of lidocaine, etidocaine, bupivacaine, and tetracaine in awake dogs following rapid intravenous administration. *Anesth. Analg.* **62**, 375–379.
- Liu, S.S., and Joseph, R.S., Jr. (2006). Local Anesthetics. In "Clinical Anesthesia." (P.G. Barash, B.F. Cullen, and R.K. Stoelting, eds.), 5th ed., pp 453–471. Lippincott Williams and Wilkins, Philadelphia, PA.
- Livingston, A., and Waterman, A.E. (1978). The development of tolerance to ketamine in rats and the significance of hepatic metabolism. *Br. J. Pharmacol.* **64**, 63–69.
- Lockwood, L.L., Silbert, L.H., Laudenslager, M.L., Watkins, L.R., and Maier, S.F. (1993). Anesthesia-induced modulation of in vivo antibody levels: A study of pentobarbital, chloral hydrate, methoxyflurane, halothane, and ketamine/xylazine. *Anesth. Analg.* **77**, 769–774.
- Lögdberg, B. (1988). Alphaxolone–alphadolone for anesthesia of squirrel monkeys of different ages. *J. Med. Primatol.* **17**, 163–167.
- Lokensgard, J.R., Chao, C.C., Gekker, G., Hu, S., and Peterson, P.K. (1998). Benzodiazepines, glia, and HIV-1 neuropathogenesis. *Mol. Neurobiol.* **18**, 23–33.
- Loomis, M.R., Henrickson, R.V., and Anderson, J.H. (1980). Effects of ketamine hydrochloride on the hemogram of rhesus monkeys (*Macaca mulatta*). *Lab. Anim. Sci.* **30**, 851–853.
- Loop, T., Liu, Z., Humar, M., Hoetzel, A., Benzing, A., Pahl, H.L., Geiger, K.K., and J Pannen, B.H. (2002). Thiopental inhibits the activation of nuclear factor kappaB. *Anesthesiology* **96**, 1202–1213.
- Löscher, W., Ganter, M., and Fassbender, C.P. (1990). Correlation between drug and metabolite concentrations in plasma and anesthetic action of ketamine in swine. *Am. J. Vet. Res.* **51**, 391–398.
- Lovell, D.P. (1986a). Variation in pentobarbitone sleeping time in mice 1. Strain and sex differences. *Lab. Anim.* **20**, 85–90.
- Lovell, D.P. (1986b). Variation in pentobarbitone sleeping time in mice 2. Variables affecting test results. *Lab. Anim.* **20**, 91–96.
- Lovell, D.P. (1986c). Variation in barbiturate sleeping time in mice 3. Strain × environment interactions. *Lab. Anim.* **20**, 307–312.
- Low, K., Crestani, F., Keist, R., Benke, D., Brunig, I., Benson, J.A., Fritschy, J.M., Rulicke, T., Bluethmann, H., Mohler, H., and Rudolph, U. (2000). Molecular and neuronal substrate for the selective attenuation of anxiety. *Science* **290**, 131–134.
- Lowson, S., Gent, J.P., and Goodchild, C.S. (1990). Anticonvulsant properties of propofol and thiopentone: Comparison using two tests in laboratory mice. *Br. J. Anaesth.* **64**, 59–63.
- Lumb, W.V., and Jones, E.W. (1984). "Veterinary Anesthesia," 2nd ed., Lea & Febiger, Philadelphia, PA.
- Luna, S.P.L., Cassu, R.N., Castro, G.B., Texeira Neto, F.J., Silva Junior, J.R., and Lopes, M.D. (2004). Effects of four anaesthetic protocols on the neurological and cardiorespiratory variables of puppies born by caesarean section. *Vet. Rec.* **154**, 387–389.
- Macdonald, R.L., and McLean, M.J. (1986). Anticonvulsant drugs: mechanisms of action. *Adv. Neurol.* **44**, 713–36.
- MacDonald, E., Haapalinn, A., Virtanen, R., and Lammintausta, R. (1989). Effects of acute administration of medetomidine on the behaviour, temperature and turnover rates of brain biogenic amines in rodents and reversal of these effects by atipamezole. *Acta Vet. Scand.* **85**(Suppl.), 77–81.
- MacDonald, E., and Virtanen, R. (1992). Review of the pharmacology of medetomidine and detomidine: Two chemically similar α_2 -adrenoreceptor agonists used in veterinary sedatives. In "Animal Pain." (C.E. Short and A. Van Poznak, eds.), pp 181–191. Churchill Livingstone, New York.
- Maggi, C.A., Manzinim, S., Parlani, M., and Meli, A. (1984). An analysis of the effects of urethane on cardiovascular responsiveness to catecholamines in terms of its interference with Ca^{++} . *Experientia* **40**, 52–59.
- Maggi, C.A., and Meli, A. (1986a). Suitability of urethane anesthesia for physiopharmacological investigations in various systems. Part 1: General considerations. *Experientia* **42**, 109–114.
- Maggi, C.A., and Meli, A. (1986b). Suitability of urethane anesthesia for physiopharmacological investigations in various systems. Part 2: Cardiovascular system. *Experientia* **42**, 292–297.
- Maggi, C.A., and Meli, A. (1986c). Suitability of urethane anesthesia for physiopharmacological investigations. Part 3: Other systems and conclusions. *Experientia* **42**, 531–537.
- Malone, E., Ensink, J., Turner, T., Wilson, J., Andrews, F., Keegan, K., and Lumsden, J. (2006). Intravenous continuous infusion of lidocaine for treatment of equine ileus. *Vet. Surg.* **35**, 60–66.
- Manders, W.T., and Vatner, S.F. (1976). Effects of sodium pentobarbital anesthesia on left ventricular function and distribution of cardiac output in dogs, with particular reference to the mechanism for tachycardia. *Circ. Res.* **39**, 512–517.
- Mann, W.A., Weizel, G., and Kinter, L.B. (1991). Hemodynamic effects of medetomidine in conscious unrestrained cynomolgus monkeys using implanted telemetric transmitters. *FASEB J.* **5**, A868.
- Marietta, M.P. (1977). Characterization of ketamine induction of hepatic microsomal drug metabolism. *Biochem. Pharmacol.* **26**, 2451–2453.
- Marik, P.E. (2004). Propofol: Therapeutic indications and side-effects. *Curr. Pharm. Des.* **10**, 3639–3649.
- Marik, P.E. (2005). Propofol: An immunomodulating agent. *Pharmacotherapy* **25**, 28S–33S.

- Marroum, P.J., Webb, A.I., Aeschbacher, G., and Curry, S.H. (1994). Pharmacokinetics and pharmacodynamics of acepromazine in horses. *Am. J. Vet. Res.* **55**, 1428–1433.
- Mårtensson, L., and Carter, A.M. (1984). Distribution of cardiac output in the late pregnant guinea pig during anaesthesia with ketamine. *Z. Versuchstierk.* **26**, 175–179.
- Matthews, N.S., Brown, R.M., Barling, K.S., Lovering, S.L., and Herrig, B.W. (2004). Repetitive propofol administration in dogs and cats. *J. Am. Anim. Hosp. Assoc.* **40**, 255–260.
- Maze, M., Buttermann, A.E., Kamibayashi, T., et al. (1997). Alpha-2 adrenergic agonists. In “Textbook of Intravenous Anesthesia.” (P.F. White, ed.), pp 433–445. Williams and Wilkins, London.
- Maze, M., and Fujinaga, M. (2000). α_2 -Adrenoreceptors in pain modulation: Which subtype should be targeted to produce analgesia? *Anesthesiology* **92**, 934–936.
- Maze, M., Hayward, E., Jr., and Gaba, D.M. (1985). Alpha 1-adrenergic blockade raises epinephrine-arrhythmia threshold in halothane-anesthetized dogs in a dose-dependent fashion. *Anesthesiology* **63**, 611–615.
- Maze, M., and Regan, J.W. (1991). Role of signal transduction in anesthetic action α_2 adrenergic agonists. *Ann. N.Y. Acad. Sci.* **625**, 409–423.
- Maze, M., and Tranquilli, W. (1991). Alpha-2 adrenoceptor agonists: Defining the role in clinical anesthesia. *Anesthesiology* **74**, 581–605.
- Maze, M., Virtanen, R., Daunt, D., Banks, S.J.M., Stover, E.P., and Feldman, D. (1991). Effects of dexmedetomidine, a novel imidazole sedative-anesthetic agent, on adrenal steroidogenesis: In vivo and in vitro studies. *Anesth. Analg.* **73**, 204–208.
- McElhatton, P.R. (1994). The effects of benzodiazepine use during pregnancy and lactation. *Reprod. Toxicol.* **8**, 461–475.
- McHale, N.G., and Thornbury, K.D. (1989). The effect of anesthetics on lymphatic contractility. *Microvasc. Res.* **37**, 70–76.
- McIntosh, M.P., Schwarting, N., and Rajewski, R.A. (2004). In vitro and in vivo evaluation of a sulfolbutyl ether beta-cyclodextrin enabled etomidate formulation. *J. Pharm. Sci.* **93**, 2585–2594.
- McKernan, R.M., Rosahl, T.W., Reynolds, D.S., Sur, C., Wafford, K.A., Atack, J.R., Farrar, S., Myers, J., Cook, G., Ferris, P., Garrett, L., Bristow, L., Marshall, G., Macaulay, A., Brown, N., Howell, O., Moore, K.W., Carling, R.W., Street, L.J., Castro, J.L., Ragan, C.I., Dawson, G.R., and Whiting, P.J. (2000). Sedative but not anxiolytic properties of benzodiazepines are mediated by the GABA(A) receptor alpha-1 subtype. *Nat. Neurosci.* **3**, 587–592.
- Menke, H., and Vaupel, P. (1988). Effect of injectable or inhalational anesthetics and of neuroleptic, neuroleptanalgesic, and sedative agents on tumor blood flow. *Radiat. Res.* **114**, 64–76.
- Mero, M., Vainiopää, S., Vasenius, J., Vihtonen, K., and Rokkanen, P. (1989). Medetomidine-ketamine-diazepam anesthesia in the rabbit. *Acta Vet. Scand.* **85**(Suppl.), 135–137.
- Meyer, R.E. (2007). Comment on Guenette, S.A., Beaudry, F., Marier, J.F., and Vachon, P. (2006). Pharmacokinetics and anesthetic activity of eugenol in male Sprague–Dawley rats. *J. Vet. Pharmacol. Ther.* **29**, 265–270. *J. vet. Pharmacol. Ther.* **30**, 91.
- Meyer, R.E., Braun, R.D., and Dewhirst, M.W. (2002). Anesthetic considerations for the study of murine tumors. In “Tumor Models in Cancer Research.” (B.A. Teicher, ed.), pp 407–431. Humana Press, Totowa, NJ.
- Meyer, R.E., and Fish, R.E. (2005). A review of tribromoethanol anesthesia for production of genetically engineered mice and rats. *Lab. Anim. (N.Y.)* **34**, 47–52.
- Milde, L.N., Milde, J.H., and Michenfelder, J.D. (1985). Cerebral functional, metabolic, and hemodynamic effects of etomidate in dogs. *Anesthesiology* **63**, 371–377.
- Miller, E.D., Kistner, J.R., and Epstein, R.M. (1980). Whole-body distribution of radioactively labelled microspheres in the rat during anesthesia with halothane, enflurane, or ketamine. *Anesthesiology* **52**, 296–302.
- Miller, J.H., McCoy, K.D., and Coleman, A.S. (2001). Renal actions of the alpha2-adrenoceptor agonist, xylazine, in the anaesthetised rat. *N.Z. Vet. J.* **49**, 173–180.
- Mills, T., Copland, A., and Osteen, K. (1981). Factors affecting the postovulatory surge of FSH in the rabbit. *Biol. Reprod.* **25**, 530–535.
- Mitterhauser, M., Wadsak, W., Wabnegger, L., Sieghart, W., Viernstein, H., Kletter, K., and Dudeczak, R. (2003). In vivo and in vitro evaluation of [18F]FETO with respect to the adrenocortical and GABAergic system in rats. *Eur. J. Nucl. Med. Mol. Imaging* **30**, 1398–1401. Epub 2003 Jul 3.
- Modica, P.A., Tempelhoff, R., and White, P.F. (1990). Pro- and anticonvulsant effects of anesthetics (Part II). *Anesth. Analg.* **70**, 433–444.
- Mohler, H., and Richards, J.G. (1988). The benzodiazepine receptor: A pharmacological control element of brain function. *Eur. J. Anaesthesiol. Suppl.* **2**, 15–24.
- Molajavi, A., Preckel, B., Comfere, T., Mullenheim, J., Thamer, V., and Schlack, W. (2001). Effects of ketamine and its isomers on ischemic preconditioning in the isolated rat heart. *Anesthesiology* **94**, 623–629; discussion 5A–6A.
- Moon, P.F. (1994). Acute toxicosis in two dogs associated with etomidate-propylene glycol infusion. *Lab. Anim. Sci.* **44**, 590–594.
- Moon, P.F. (1997). Cortisol suppression in cats after induction of anesthesia with etomidate, compared with ketamine–diazepam combination. *Am. J. Vet. Res.* **58**, 868–871.
- Moore, T.C., and Khan, F. (1986). Lymphocyte traffic effects of systemic and local lidocaine in sheep. *J. Surg. Res.* **41**, 279–285.
- Moreira, L.B., Kasetsuwan, N., Sanchez, D., Shah, S.S., LaBree, L., and McDonnell, P.J. (1999). Toxicity of topical anesthetic agents to human keratocytes in vivo. *J. Cataract Refract. Surg.* **25**, 975–980.
- Morey, T.E., Modell, J.H., Shekhawat, D., Grand, T., Shah, D.O., Gravenstein, N., McGorray, S.P., and Dennis, D.M. (2006a). Preparation and anesthetic properties of propofol microemulsions in rats. *Anesthesiology* **104**, 1184–1190.
- Morey, T.E., Modell, J.H., Shekhawat, D., Shah, D.O., Klatt, B., Thomas, G.P., Kero, F.A., Booth, M.M., and Dennis, D.M. (2006b). Anesthetic properties of a propofol microemulsion in dogs. *Anesth. Analg.* **103**, 882–887.
- Morris, T., and Appbly, R. (1980). Retardation of wound healing by procaine. *Br. J. Surg.* **67**, 391–392.
- Mosby, H.S., and Canter, D.E. (1956). The use of avertin in capturing wild turkeys and as an oral-basal anesthetic in other wild animals. *Southwest Vet.* **9**, 132.
- Muir, W.W. (1977). Thiobarbiturate-induced dysrhythmias: The role of heart rate and autonomic imbalance. *Am. J. Vet. Res.* **38**, 1377–1381.
- Muir, W.W. (1985). Cyclohexanone drug mixtures: The pharmacology of ketamine and ketamine drug combinations. *Proc. 2nd. Intl. Cong. Vet. Anes.* **5**–14.
- Muir, W.W., Bednarski, L., and Bednarski, R. (1991). Thiamylal- and halothane-sparing effect of diazepam in dogs. *J. Vet. Pharmacol. Ther.* **14**, 46–50.
- Muir, W.W., and Hubbell, J.A.E. (1985). Blood pressure response to acetylpromazine and lenperone in halothane anesthetized dogs. *J. Am. Anim. Hosp. Assoc.* **21**, 285–289.
- Muir, W.W., and Hubbell, J.A.E. (1988). Cardiopulmonary and anesthetic effects of ketamine and its enantiomers in dogs. *Am. J. Vet. Res.* **49**, 530–534.
- Muir, W.W., and Mason, D.E. (1989). Side effects of etomidate in dogs. *J. Am. Vet. Med. Assoc.* **194**, 1430–1434.
- Muir, W.W., Werner, L.L., and Hamlin, R.L. (1975). Arrhythmias in dogs associated with epinephrine and thiamylal anesthesia. *Am. J. Vet. Res.* **36**, 1291–1297.
- Mullenheim, J., Molajavi, A., Preckel, B., Thamer, V., and Schlack, W. (2001a). Thiopentone does not block ischemic preconditioning in the isolated rat heart. *Can. J. Anaesth.* **48**, 784–789.
- Mullenheim, J., Rulands, R., Wietschorke, T., Frassdorf, J., Preckel, B., and Schlack, W. (2001b). Late preconditioning is blocked by racemic ketamine, but not by S(+)-ketamine. *Anesth. Analg.* **93**, 265–270.
- Murrell, J.C., and Hellebrekers, L.J. (2005). Medetomidine and dexmedetomidine: A review of cardiovascular effects and antinociceptive properties in the dog. *Vet. Anaesth. Analg.* **32**, 117–127.

- Murthy, V.S., Zagar, M.E., Vollmer, R.R., and Schmidt, D.H. (1982). Pentobarbital-induced changes in vagal tone and reflex vagal activity in rabbits. *Eur. J. Pharmacol.* **84**, 41–50.
- Myslobodsky, M.S., Golovchinsky, V., and Mintz, M. (1981). Ketamine: Convulsant or anti-convulsant? *Pharmacol. Biochem. Behav.* **14**, 27–33.
- Nadeson, R., and Goodchild, C.S. (2001). Antinociceptive properties of neurosteroids III: Experiments with alphadolone given intravenously, intraperitoneally, and intragastrically. *Br. J. Anaesth.* **86**, 704–708.
- Naftalin, R.J., Cunningham, P., and Afzal-Ahmed, I. (2004). Piracetam and TRH analogues antagonise inhibition by barbiturates, diazepam, melatonin and galanin of human erythrocyte D-glucose transport. *Br. J. Pharmacol.* **142**, 594–608.
- Nagy, J., and Decsi, L. (1978). Physostigmine, a highly potent antidote for acute experimental diazepam intoxication. *Neuropharmacology* **17**, 469–475.
- Nakagawa, T., Hirakata, H., Sato, M., Nakamura, K., Hatano, Y., Nakamura, T., and Fukuda, K. (2002). Ketamine suppresses platelet aggregation possibly by suppressed inositol triphosphate formation and subsequent suppression of cytosolic calcium increase. *Anesthesiology* **96**, 1147–1152.
- National Toxicology Program (NTP). (2000). Report on Carcinogens, 9th ed. National Institute of Environmental Health Sciences, National Institutes of Health, Research Triangle Park, NC.
- Nazian, S.J. (1988). Serum concentrations of reproductive hormones after administration of various anesthetics to immature and young adult male rats. *Proc. Soc. Exp. Biol. Med.* **187**, 482–487.
- Neumann, R., Worek, F.S., Blumel, G., Zimmermann, G.J., Fehm, H.L., and Pfeiffer, U.J. (1989). Cortisol deficiency in metomidate anesthetized bacteremic pigs: Results in circulatory failure—beneficial effect of cortisol substitution. *Acta Anaesthesiol. Scand.* **33**, 379–384.
- Nevalainen, T., Pyhälä, L., Voipio, H., and Virtanen, R. (1989). Evaluation of anaesthetic potency of medetomidine–ketamine combination in rats, guinea-pigs and rabbits. *Acta Vet. Scand.* **85**(Suppl.), 139–143.
- Niemegeers, C.J.E., Van Nueten, J.M., and Janssen, P.A.J. (1974). Azaperone, a sedative neuroleptic of the butyrophenone series with pronounced anti-aggressive and anti-shock activity in animals. *Drug Res.* **24**, 1798–1806.
- Nishina, K., Akamatsu, H., Mikawa, K., Shiga, M., Maekawa, N., Obara, H., and Niwa, Y. (1998). The inhibitory effects of thiopental, midazolam, and ketamine on human neutrophil functions. *Anesth. Analg.* **86**, 159–165.
- Nomeir, A.A., Ioannou, Y.M., Sanders, J.M., and Matthews, H.B. (1989). Comparative metabolism and disposition of ethyl carbamate (urethane) in male Fisher 344 rats and male B6C3F1 mice. *Toxicol. Appl. Pharmacol.* **97**, 203–215.
- Norris, M.L., and Turner, W.D. (1983). An evaluation of tribromoethanol (TBE) as an anaesthetic agent in the Mongolian gerbil (*Meriones unguiculatus*). *Lab. Anim.* **17**, 324–329.
- Nunn, J.F., Utting, J.E., and Brown, B.R., Jr. (1989). Introduction. In “General Anaesthesia.” (J.F. Nunn, J.E. Utting and B.R. Brown, Jr., eds.), 5th ed., pp 1–6. Butterworths, London.
- Ochsner, A.J. (1977). Cardiovascular and respiratory responses to ketamine hydrochloride in the rhesus monkey (*Macaca mulatta*). *Lab. Anim. Sci.* **27**, 69–71.
- Ogino, K., Hobara, T., Kobayashi, H., and Iwamoto, S. (1990). Gastric mucosal injury induced by chloral hydrate. *Toxicol. Lett.* **52**, 129–133.
- Oguchi, K., Arakawa, K., Nelson, S.R., and Samson, F. (1982). The influence of droperidol, diazepam, and physostigmine on ketamine-induced behavior and brain regional glucose utilization in rat. *Anesthesiology* **57**, 353–358.
- Olivar, T., and Laird, J.M. (1999). Differential effects of N-methyl-D-aspartate receptor blockade on nociceptive somatic and visceral reflexes. *Pain* **79**, 67–73.
- Olson, M.E., McCabe, K., and Walker, R.L. (1987). Guaifenesin alone or in combination with ketamine or sodium pentobarbital as an anesthetic in rabbits. *Can. J. Vet. Res.* **51**, 383–386.
- Olson, M.E., and Renchko, P. (1988). Azaperone and azaperone–ketamine as a neuroleptic sedative and anesthetic in rats and mice. *Lab. Anim. Sci.* **38**, 299–304.
- Olsen, R.W. (1987). GABA-drug interactions. *Prog. Drug Res.* **31**, 223–241.
- Ongioco, R.R., Richardson, C.D., Rudner, X.L., Stafford-Smith, M., and Schwinn, D.A. (2000). Alpha2-adrenergic receptors in human dorsal root ganglia: Predominance of alpha2b and alpha2c subtype mRNAs. *Anesthesiology* **92**, 968–976.
- Ostrowski, S., and Ancrenaz, M. (1995). Chemical immobilisation of red-necked ostriches (*Struthio camelus*) under field conditions. *Vet. Rec.* **136**, 145–147.
- Pablo, L.S., Bailey, J.E., and Ko, J.C. (1997). Median effective dose of propofol required for induction of anaesthesia in goats. *J. Am. Vet. Med. Assoc.* **211**, 86–88.
- Pacher, P., and Kecskemeti, V. (2004). Cardiovascular side effects of new antidepressants and antipsychotics: New drugs, old concerns? *Curr. Pharm. Des.* **10**, 2463–2475.
- Papaioannou, V.E., and Fox, J.G. (1993). Efficacy of tribromoethanol anesthesia in mice. *Lab. Anim. Sci.* **43**, 189–192.
- Parker, J.L., and Adams, H.R. (1978). The influence of chemical restraining agents on cardiovascular function: A review. *Lab. Anim. Sci.* **28**, 575–583.
- Pascoe, P.J. (1992). The case for maintenance of general anesthesia with an injectable agent. *Vet. Clin. North Am. Small Anim. Pract.* **22**, 275–276.
- Pascoe, P.J., Ilkiw, J.E., Haskins, S.C., and Patz, J.D. (1992). Cardiopulmonary effects of etomidate in hypovolemic dogs. *Am. J. Vet. Res.* **53**, 2178–2182.
- Pateromichelakis, S., and Prokopiou, A.A. (1988). Local anaesthesia efficacy: Discrepancies between in vitro and in vivo studies. *Acta Anaesthesiol. Scand.* **32**, 672–675.
- Pathirathna, S., Brimelow, B.C., Jagodic, M.M., Krishnan, K., Jiang, X., Zorunski, C.F., Mennerick, S., Covey, D.F., Todorovic, S.M., and Jevtovic-Todorovic, V. (2005). New evidence that both T-type calcium channels and GABA-A channels are responsible for the potent peripheral analgesic effects of 5 α -reduced neuroactive steroids. *Pain* **114**, 429–443.
- Pavlovic, M., Wroblewski, K., Manevich, Y., Kim, S., and Biaglow, J.E. (1996). The importance of choice of anesthetics in studying radiation effects in the 9L rat glioma. *Br. J. Cancer Suppl.* **27**, S222–S225.
- Payton, A.J., and Pick, J.R. (1989). Evaluation of a combination of tiletamine and zolazepam as an anesthetic for ferrets. *Lab. Anim. Sci.* **39**, 243–246.
- Perez, R., Garcia, M., Arias, P., Gallardo, M., Valenzuela, S., and Rudolph, M.I. (1997). Inhibition of xylazine induced uterine contractility by clenbuterol and nifedipine. *Res. Vet. Sci.* **63**, 73–76.
- Pertovaara, A., Haapalinna, A., Sirvio, J., and Virtanen, R. (2005). Pharmacological properties, central nervous system effects, and potential therapeutic applications of atipamezole, a selective alpha2-adrenoceptor antagonist. *CNS Drug Rev.* **11**, 273–288.
- Pertovaara, A., Kauppila, T., Jyvasjarvi, E., and Kalso, E. (1991). Involvement of supraspinal and spinal segmental alpha-2-adrenergic mechanisms in the medetomidine-induced antinociception. *Neuroscience* **44**, 705–714.
- Pertovaara, A., Kauppila, T., and Tukeva, T. (1990). The effect of medetomidine, an α_2 -adrenoceptor agonist, in various pain tests. *Eur. J. Pharmacol.* **179**, 323–328.
- Peterson, S.L. (1989). Anticonvulsant profile of an anesthetic steroid. *Neuropharmacology* **28**, 877–879.
- Pettinger, W.A., Tanaka, K., Keeton, K., Campbell, W.B., and Brooks, S.N. (1975). Renin release, an artifact of anesthesia and its implications in rats. *Proc. Soc. Exp. Biol. Med.* **148**, 625–630.
- Pfenninger, E., Dick, W., and Ahnefeld, F.W. (1985). The influence of ketamine on both normal and raised intracranial pressure of artificially ventilated animals. *Eur. J. Anaesth.* **2**, 297–307.
- Ponte, J., and Sadler, C.L. (1989). Effect of thiopentone, etomidate and propofol on carotid body chemoreceptor activity in the rabbit and the cat. *Br. J. Anaesth.* **62**, 41–45.
- Popitz-Bergez, F.A., Leeson, S., Strichartz, G.R., and Thalhammer, J.G. (1995). Relation between functional deficit and intraneural local anesthetic during peripheral nerve block. A study in the rat sciatic nerve. *Anesthesiology* **83**, 583–592.

- Porter, D.B., and Slusser, C.A. (1985). Azaperone: A review of a new neuroleptic agent for swine. *Vet. Med.* **80**(March), 88–92.
- Pozzi, A., Muir, W.W. III, and Traverso, F. (2006). J Prevention of central sensitization and pain by *N*-methyl-D-aspartate receptor antagonists. *Am. Vet. Med. Assoc.* **228**, 53–60.
- Preziosi, P., and Vacca, M. (1988). Adrenocortical suppression and other endocrine effects of etomidate. *Life Sci.* **42**, 477–489.
- Quinn, G.P., Axelrod, J., and Brodie, B.B. (1958). Species, strain, and sex differences in metabolism of hexobarbitone, amidopyrine, antipyrine and aniline. *Biochem. Pharmacol.* **1**, 152–159.
- Raekallio, M., Vainio, O., and Scheinin, M. (1991). Detomidine reduces the plasma catecholamine, but not cortisol concentrations in horses. *Zentralbl Veterinarmed A.* **38**, 153–156.
- Rall, T.W. (1990). Hypnotics and sedatives; ethanol. In "Goodman and Gilman's The Pharmacological Basis of Therapeutics." (A.G. Gilman, T.W. Rall, A.S. Nies, and P. Taylor, eds.), 8th ed., pp 345–382. Pergamon Press, New York.
- Raman, J., Stewart, R., Montano, M., Reginald, S.A., and Lord, M.D. (1989). Assisted local anaesthesia in rabbits. *Microsurgery* **10**, 75–76.
- Ramirez-Gonzalez, M.D., Barna, I., Wiegant, V.M., and de Jong, W. (1991). Effect of anaesthetics on the release of beta-endorphin-immunoreactivity in rat plasma. *Life Sci.* **48**, 1371–1377.
- Rank, J., and Jensen, A.-G. (1989). The value of anaesthetic steroids alphaxolone-alphadolone in pregnant mice. *Scand. J. Lab. Anim. Sci.* **16**, 115–117.
- Redman, H.C., Wilson, G.L., and Hogan, J.E. (1973). Effect of chlorpromazine combined with intermittent light stimulation on the electroencephalogram and clinical response of the Beagle dog. *Am. J. Vet. Res.* **34**, 929–936.
- Rehm, W.F., and Schatzmann, U. (1986). Pharmacological properties of benzodiazepines in animals. In "Comparative Veterinary Pharmacology, Toxicology and Therapy." (A.S.J.P.A.M. Van Miert, M.G. Bogaert and M. Debackere), pp 13–23. MTP Press Limited, Boston, MA.
- Reich, D.L. and Silvey, G. (1989). Ketamine: An update on the first twenty-five years of clinical experience. *Can. J. Anaesth.* **36**, 186–197.
- Reid, W.C., Carmichael, K.P., Srinivas, S., and Bryant, J.L. (1999). Pathologic changes associated with use of tribromoethanol (avertin) in the Sprague Dawley rat. *Lab. Anim. Sci.* **49**, 665–667.
- Reid, W.D., Davies, C., Pare, P.D., and Pardy, R.L. (1989). An effective combination of anaesthetics for 6-h experimentation in the golden Syrian hamster. *Lab. Anim.* **23**, 156–162.
- Reinert, H. (1964). Urethane hyperglycaemia and hypothalamic activation. *Nature* **204**, 889–891.
- Reutlinger, R.A., Karl, A.A., Vinal, S.I., and Nieser, M. (1980). Effects of ketamine HCl-xylazine HCl combination on cardiovascular and pulmonary values of the rhesus macaque (*Macaca mulatta*). *Am. J. Vet. Res.* **41**, 1453–1457.
- Reyes Toso, C.F., Linares, L.M., and Rodriguez, R.R. (1995). Blood sugar concentrations during ketamine or pentobarbitone anesthesia in rats with or without alpha and beta adrenergic blockade. *Medicina (B. Aires)* **55**, 311–316.
- Reynolds, J.E.F. (ed.). (1982). "Martindale: The Extra Pharmacopoeia," 29th ed., p 760. The Pharmaceutical Press, London.
- Rice, J.M., Diwan, B.A., Hu, H., Ward, J.M., Nims, R.W., and Lubet, R.A. (1994). Enhancement of hepatocarcinogenesis and induction of specific cytochrome P450-dependent monooxygenase activities by the barbiturates allobarbitol, aprobarbitol, pentobarbitol, secobarbitol and 5-phenyl- and 5-ethylbarbituric acids. *Carcinogenesis* **15**(2), 395–402.
- Rieg, T., Richter, K., Osswald, H., and Vallon, V. (2004). Kidney function in mice: Thiobutobarbital versus alpha-chloralose anesthesia. *Naunyn-Schmiedeberg's Arch Pharmacol.* **370**(4), 320–323. Epub 2004 Sep 30.
- Ritchie, J.M., and Greene, N.M. (1990). Local anesthetics. In "Goodman and Gilman's The Pharmacological Basis of Therapeutics." (A.G. Gilman, T.W. Rall, A.S. Nies, and P. Taylor, eds.), 8th ed., pp 311–331. Pergamon Press, New York.
- Riviere, J.E., Martin-Jimenez, T., Sundlof, S.F., and Craigmill, A.L. (1997). Interspecies allometric analysis of the comparative pharmacokinetics of 44 drugs across veterinary and laboratory animal species. *J. Vet. Pharmacol. Ther.* **20**, 453–463.
- Riviere, J.E., and Papich, M.G. (2001). Potential and problems of developing transdermal patches for veterinary applications. *Adv. Drug Deliv. Rev.* **50**, 175–203.
- Robertson, S. (1992). Advantages of etomidate use as an anesthetic agent. *Vet. Clin. North Am. Small Anim. Pract.* **22**, 277–280.
- Rocchiccioli, C., Saad, M.A.A., and Elghozi, J.-L. (1989). Attenuation of the baroreceptor reflex by propofol anesthesia in the rat. *J. Cardiovasc. Pharmacol.* **14**, 631–635.
- Rodrigues, S.F., de Oliveira, M.A., Martins, J.O., Sannomiya, P., de Cassia Tostes, R., Nigro, D., Carvalho, M.H.C., and Fortes, Z.B. (2006). Differential effects of chloral hydrate- and ketamine/xylazine-induced anesthesia by the s.c. route. *Life Sci.* **79**, 1630–1637.
- Rodriguez-Lopez, J.M., Sanchez-Conde, P., Lozano, F.S., Nicolas, J.L., Garcia-Criado, F.J., Cascajo, C., and Muriel, C. (2006). Laboratory investigation: Effects of propofol on the systemic inflammatory response during aortic surgery. *Can. J. Anaesth.* **53**, 701–710.
- Rodriguez-Martinez, H., McKenna, D., Weston, P.G., Gustafsson, B.K., and Whitmore, H.L. (1987). Uterine motility in the cow during the estrous cycle. III. Effects of oxytocin, xylazine, and adrenoceptor blockers. *Theriogenology* **27**, 359–368.
- Rose, W.C., Munson, A.E., and Bradley, S.G. (1973). Acute lethality for mice following administration of cyclophosphamide with barbiturates (37241). *Proc. Soc. Exp. Biol. Med.* **143**, 1–5.
- Roth, D.M., Swaney, J.S., Dalton, N.D., Gilpin, E.A. and Ross, J., Jr. (2002). Impact of anesthesia on cardiac function during echocardiography in mice. *Am. J. Physiol. Heart Circ. Physiol.* **282**, H2134–H2140.
- Rudolph, U., and Mohler, H. (2004). Analysis of GABAA receptor function and dissection of the pharmacology of benzodiazepines and general anesthetics through mouse genetics. *Annu. Rev. Pharmacol. Toxicol.* **44**, 475–498.
- Rudy, D.C., Downie, J.W., and McAndrew, J.D. (1991). Alpha-chloralose alters autonomic reflex function of the lower urinary tract. *Am. J. Physiol.* **261**, R1560–R1567.
- Ruskoaho, H., and Leppälüoto, J. (1989). The effect of medetomidine, an α_2 -adrenoceptor agonist, on plasma atrial natriuretic peptide levels, haemodynamics and renal excretory function in spontaneously hypertensive and Wistar-Kyoto rats. *Br. J. Pharmacol.* **97**, 125–132.
- Ryder, S., Way, W.L., and Trevor, A.J. (1978). Comparative pharmacology of the optical isomers of ketamine in mice. *Eur. J. Pharmacol.* **49**, 15–23.
- Saleh, N., Aoki, M., Shimada, T., Akiyoshi, H., Hassanin, A., and Ohashi, F.J. (2005). Renal effects of medetomidine in isoflurane-anesthetized dogs with special reference to its diuretic action. *Vet. Med. Sci.* **67**, 461–465.
- Salonen, J.S. (1986). Pharmacokinetics of detomidine. *Acta Vet. Scand.* **82**(Suppl.), 59–66.
- Salonen, J.S. (1989). Pharmacokinetics of medetomidine. *Acta Vet. Scand.* **85**(Suppl.), 49–54.
- Salonen, J.S. (1992). Chemistry and pharmacokinetics of the α_2 -adrenoceptor agonists. In "Animal Pain." (C.E. Short and A. Van Poznak, eds.), pp 191–200. Churchill Livingstone, New York.
- Sapru, H.N., and Krieger, A.J. (1979). Cardiovascular and respiratory effects of some anesthetics in the decerebrate rat. *Eur. J. Pharmacol.* **53**, 151–158.
- Saunders, P.A., and Ho, I.K. (1990). Barbiturates and the GABAA receptor complex. *Prog. Drug Res.* **34**, 261–286.
- Savola, J.-M. (1986). Cardiovascular actions of detomidine. *Acta Vet. Scand.* **82**(Suppl.), 47–57.
- Savola, J.-M. (1989). Cardiovascular actions of medetomidine and their reversal by atipamezole. *Acta Vet. Scand.* **85**(Suppl.), 39–47.
- Savola, J.-M., Ruskoaho, H., Puurunen, J., Salonen, J.S., and Kärki, N.T. (1986). Evidence for medetomidine as a selective and potent agonist at α_2 -adrenoceptors. *J. Auton. Pharmacol.* **5**, 275–284.
- Savola, M., Savola, J.-M., and Puurunen, J. (1989). α_2 -Adrenoceptor-mediated inhibition of gastric acid secretion by medetomidine is efficiently antagonized by atipamezole in rats. *Arch. Int. Pharmacodyn.* **301**, 267–276.

- Sawyer, D.C., Lumb, W.V., and Stone, H.L. (1971). Cardiovascular effects of halothane, methoxyflurane, pentobarbital, and thiamylal. *J. Appl. Physiol.* **30**, 36–43.
- Scarfone, E., Ulfendahl, M., Figueroa, L., and Flock, A. (1991). Anaesthetics may change the shape of isolated Type I hair cells. *Hear. Res.* **54**, 247–250.
- Sceniak, M.P., and MacIver, M.B. (2006). Cellular actions of urethane on rat visual cortical neurons in vitro. *J. Neurophysiol.* **95**, 3865–3874.
- Schaefer, C.F., Brackett, D.J., Biber, B., Lerner, M.R., Holaday, J.W., Wilson, M.F., and Fagraeus, L. (1989). Respiratory and cardiovascular effects of thyrotropin-releasing hormone as modified by isoflurane, enflurane, pentobarbital and ketamine. *Regul. Pept.* **24**, 269–282.
- Schatzmann, U., Jossfck, H., Stauffer, J.L., and Goossens, L. (1994). Effects of alpha 2-agonists on intrauterine pressure and sedation in horses: Comparison between detomidine, romifidine and xylazine. *Zentralbl. Veterinarmed. A* **41**, 523–529.
- Scheinin, M., and Macdonald, E. (1989). An introduction to the pharmacology of α_2 -adrenoceptors in the central nervous system. *Acta Vet. Scand.* **85**(Suppl.), 11–19.
- Schelling, C.G., and Klein, L.V. (1985). Comparison of carbonated lidocaine and lidocaine hydrochloride for caudal epidural anesthesia in horses. *Am. J. Vet. Res.* **46**, 1375–1377.
- Schenkman, K.A., and Yan, S. (2000). Propofol impairment of mitochondrial respiration in isolated perfused guinea pig hearts determined by reflectance spectroscopy. *Crit. Care Med.* **28**, 172–177.
- Schlumpf, M., Parmar, R., Schreiber, A., Ramseier, H.R., Butikofer, E., Abriel, H., Barth, M., Rhyner, T., and Lichtensteiger, W. (1992). Nervous and immune systems as targets for developmental effects of benzodiazepines. A review of recent studies. *Dev. Pharmacol. Ther.* **18**, 145–158.
- Schmidt, S.H., Hellstrom, S., and Anniko, M. (1988). Structural effects of the topical lidocaine-prilocaine anesthetic Emla on the tympanic membrane. *Arch. Otorhinolaryngol.* **245**, 136–141.
- Schmidtt, H., Le Douarec, J.-C., and Petillot, N. (1974). Antagonism of the antinociceptive action of xylazine, an α -sympathomimetic agent, by adrenoceptor and cholinceptor blocking agents. *Neuropharmacology* **13**, 295–303.
- Schneemilch, C.E., Schilling, T., and Bank, U. (2004). Effects of general anaesthesia on inflammation. *Best Pract. Res. Clin. Anaesthesiol.* **18**, 493–507.
- Schoemaker, N.J., Mol, J.A., Lumeij, J.T., Thijssen, J.H., and Rijnberk, A. (2003). Effects of anaesthesia and manual restraint on the plasma concentrations of pituitary and adrenocortical hormones in ferrets. *Vet. Rec.* **152**, 591–595.
- Schug, S.A., Saunders, D., Kurowski, I., and Paech, M.J. (2006). Neuraxial drug administration: A review of treatment options for anaesthesia and analgesia. *CNS Drugs.* **20**, 917–933.
- Schwartz, D.A., and Horwitz, L.D. (1975). Effects of ketamine on left ventricular performance. *J. Pharmacol. Exp. Ther.* **194**, 410–414.
- Schwedler, M., Miletich, D.J., and Albrecht, R.F. (1982). Cerebral blood flow and metabolism following ketamine administration. *Can. Anaesth. Soc. J.* **29**, 222–226.
- Schwenke, D.O. and Cragg, P.A. (2004). Comparison of the depressive effects of four anesthetic regimens on ventilatory and cardiovascular variables in the guinea pig. *Comp. Med.* **54**, 77–85.
- Sear, J.W. (1996). Steroid anesthetics: Old compounds, new drugs. *J. Clin. Anesth.* **8**, 91S–98S.
- Sebel, P.S. and Lowdon, J.D. (1989). Propofol: A new intravenous anesthetic. *Anesthesiology* **71**, 260–277.
- Seddon, T., Michelle, I., and Chenery, R.J. (1989). Comparative drug metabolism of diazepam in hepatocytes isolated from man, rat, monkey and dog. *Biochem. Pharmacol.* **38**, 1657–1665.
- Seeman, P., and Kapur, S. (2003). Anesthetics inhibit high-affinity states of dopamine D2 and other G-linked receptors. *Synapse* **50**, 35–40.
- Sell, A.B., and Carlini, E.A. (1976). Anesthetic action of methyleugenol and other eugenol derivatives. *Pharmacology* **14**, 367–377.
- Semple, H.A., Goreck, D.K., Farley, S.D., and Ramsay, M.A. (2000). Pharmacokinetics and tissue residues of Telazol in free-ranging polar bears. *J. Wildl. Dis.* **36**, 653–662.
- Seubert, C.N., Morey, T.E., Martynyuk, A.E., Cucchiara, R.F., and Dennis, D.M. (2000). Midazolam selectively potentiates the A(2A)—but not A1-receptor-mediated effects of adenosine: Role of nucleoside transport inhibition and clinical implications. *Anesthesiology* **92**, 567–577.
- Severinghaus, J.W., Xu F.D., and Spellman, M.J., Jr. (1991). Benzocaine and methemoglobin. *Anesthesiology* **74**, 385–386.
- Severs, W.B., Keil, L.C., Klase, P.A., and Deen, K.C. (1981). Urethane anesthesia in rats. Altered ability to regulate hydration. *Pharmacology* **22**, 209–226.
- Seyde, W.C., McGowan, L., Lund, N., Duling, B., and Longnecker, D.E. (1985). Effects of anesthetics on regional hemodynamics in normovolemic and hemorrhaged rats. *Am. J. Physiol.* **249**, H164–H173.
- Seymour, C. (1999). Caesarian Section. In “Manual of Small Animal Anaesthesia and Analgesia.” (C. Seymour and R. Gleed, eds.), pp 217–222. British Small Animal Veterinary Association, Cheltenham, UK.
- Sharma, R.P., Stowe, C.M., and Good, A.L. (1970). Studies on the distribution and metabolism of thiopental in cattle, sheep, goats, and swine. *J. Pharmacol. Exp. Ther.* **172**, 128–137.
- Shibakawa, Y.S., Sasaki, Y., Goshima, Y., Echigo, N., Kamiya, Y., Kurahashi, K., Yamada, Y., and Andoh, T. (2005). Effects of ketamine and propofol on inflammatory responses of primary glial cell cultures stimulated with lipopolysaccharide. *Br. J. Anaesth.* **95**, 803–810. Epub 2005 Oct 14.
- Shimokawa, A., Kunitake, T., Takasaki, M., and Kannan, H. (1998). Differential effects of anesthetics on sympathetic nerve activity and arterial baroreceptor reflex in chronically instrumented rats. *J. Auton. Nerv. Sys.* **72**, 46–54.
- Shirasaka, Y., and Wasterlain, C.G. (1995). The effect of urethane anesthesia on evoked potentials in dentate gyrus. *Eur. J. Pharm.* **282**, 11–17.
- Short, C.E. (1987). Neuroleptanalgesia and alpha-adrenergic receptor analgesia. In “Principles and Practice of Veterinary Anesthesia.” (C.E. Short, ed.), pp 47–57. Waverly Press, Inc., Baltimore, MD.
- Short, T.G., and Young, Y. (2003). Toxicity of intravenous anaesthetics. *Best Pract. Res. Clin. Anaesthesiol.* **17**, 77–89.
- Silverman, J. (2003). Protocol Review. Anesthetics in GEM: Does TBE make the grade? *Lab Anim. (N.Y.)* **32**, 19–21.
- Silverman, J., Huhndorf, M., Balk, M., and Slater, G. (1983). Evaluation of a combination of tiletamine and zolazepam as an anesthetic for laboratory rodents. *Lab. Anim. Sci.* **33**, 457–460.
- Silverman, J., and Muir, W.W., III. (1993). A review of laboratory animal anesthesia with chloral hydrate and chloralose. *Lab. Anim. Sci.* **43**, 210–216.
- Sinclair, R., Eriksson, A.S., Gretzer, C., Cassuto, J., and Thomsen, P. (1993). Inhibitory effects of amide local anaesthetics on stimulus-induced human leukocyte metabolic activation, LTB4 release and IL-1 secretion in vitro. *Acta Anaesthesiol. Scand.* **37**, 159–165.
- Sinnott, C.J., Garfield, J.M., Thalhammer, J.G., and Strichartz, G.R. (2000). Addition of sodium bicarbonate to lidocaine decreases the duration of peripheral nerve block in the rat. *Anesthesiology* **93**, 1045–1052.
- Skarda, R.T. (1996). Local and regional anesthetic and analgetic techniques. In “Lumb and Jones’ Veterinary Anesthesia.” (J.C. Thurmon, W.J. Tranquilli, and G.J. Benson, eds.), 3rd ed., pp 426–514. Lippincott Williams and Wilkins, New York.
- Skipper, H.E., Bennett, L.L., Jr., Bryan, C.E., White, L., Jr., Newton, M.A., and Simpson, L. (1951). Carbamates in the chemotherapy of leukemia VIII. Overall tracer studies on carbonyl-labeled urethane, methylene-labeled urethane, and methylene-labeled ethyl alcohol. *Cancer Res.* **11**, 46–51.
- Sklar, G.E. (1997). Propofol and postoperative infections. *Ann. Pharmacother.* **31**, 1521–1523.
- Skolleborg, K.C., Grönbech, J.E., Grong, K., Åbyholm, F.E., and Lekven, J. (1990). Distribution of cardiac output during pentobarbital versus midazolam/fentanyl/fluanisone anaesthesia in the rat. *Lab. Anim.* **24**, 221–227.

- Sladky, K.K., Swanson, C.R., Stoskopf, M.K., Loomis, M.R., and Lewbart, G.A. (2001). Comparative efficacy of tricaine methanesulfonate and clove oil for use as anesthetics in red pacu (*Piaractus brachyomus*). *Am. J. Vet. Res.* **62**, 337–342.
- Small, B.C. (2003). Anesthetic efficacy of metomidate and comparison of plasma cortisol responses to tricaine methanesulfonate, quinaldine, and clove oil-anesthetized channel catfish *Ictalurus punctatus*. *Aquaculture* **218**, 177–185.
- Smith, A.C., Zellner, J.L., Spinale, F.G., and Swindle, M.M. (1991). Sedative and cardiovascular effects of midazolam in swine. *Lab. Anim. Sci.* **41**, 157–161.
- Soma, L.R. (1971). In "Textbook of Veterinary Anesthesia." (L.R. Soma, ed.), p 147. Williams and Wilkins, Baltimore, MD.
- Soma, L.R. (1983). Anesthetic and analgesic considerations in the experimental animal. *Ann. N.Y. Acad. Sci.* **406**, 32–47.
- Sonner, J.M., Zhang, Y., Stabernack, C., Abaigar, W., Xing, Y., and Laster, M.J. (2003). GABA(A) receptor blockade antagonizes the immobilizing action of propofol but not ketamine or isoflurane in a dose-related manner. *Anesth. Analg.* **96**, 706–712.
- Soto, C.G., and Burhanuddin, A.F. (1995). Clove oil as a fish anesthetic for measuring length and weight of rabbitfish (*Siganus lineatus*). *Aquaculture* **136**, 149–152.
- Sotomayor, R.E., and Collins, T.F. (1990). Mutagenicity, metabolism, and DNA interactions of urethane. *Toxicol. Ind. Health* **6**, 71–108.
- Sou, J.H., Chan, M.H., and Chen, H.H. (2006). Ketamine, but not propofol, anaesthesia is regulated by metabotropic glutamate 5 receptors. *Br. J. Anaesth.* **96**, 597–601. Epub 2006 Mar 10.
- Spath, M., and Schweickert W. (1977). The effect of Metacaine (ms-222) on the activity of the efferent and afferent nerves in the teleost lateral-line system. *Naunyn-Schmiedeberg's Arch. Pharmacol.* **297**, 9–19.
- Spriggs, T.L.B., and Stockham, M.A. (1964). Urethane anaesthesia and pituitary-adrenal function in the rat. *J. Pharm. Pharmacol.* **16**, 603–610.
- Stanley, T.H. (1973). Blood-pressure and pulse-rate responses to ketamine during general anesthesia. *Anesthesiology* **39**, 648–649.
- Stenberg, D. (1989). Physiological role of α_2 -adrenoceptors in the regulation of vigilance and pain: Effect of medetomidine. *Acta Vet. Scand.* **85**(Suppl.), 21–28.
- Stepien, R.L., Bonagura, J.D., Bednarski, R.M., and Muir, W.W. III. (1995). Cardiorespiratory effects of acepromazine maleate and buprenorphine hydrochloride in clinically normal dogs. *Am. J. Vet. Res.* **56**, 78–84. Erratum in: (1995); **56**, 402.
- Steward, C.A., Marsden, C.A., Prior, M.J., Morris, P.G., and Shah, Y.B. (2005). Methodological considerations in rat brain BOLD contrast pharmacological MRI. *Psychopharmacology (Berl.)* **180**, 687–704. Epub 2005 Sep 14.
- Stoelting, R.K., and Hillier, S.C. (2006). "Pharmacology and Physiology in Anesthetic Practice," 4th ed. Lippincott Williams and Wilkins, Philadelphia, PA.
- Storer, R.J., Butler, P., Hoskin, K.L., and Goadsby, P.J. (1997). A simple method, using 2-hydroxypropyl-B-cyclodextrin, of administering α -chloralose at room temperature. *J. Neurosci. Meth.* **77**, 49–53.
- Stowe, D.F., Bosnjak, Z.J., and Kampine, J.P. (1992). Comparison of etomidate, ketamine, midazolam, propofol, and thiopental on function and metabolism of isolated hearts. *Anesth. Analg.* **74**, 547–558.
- Stratford, A.F., Zoutman, D.E., and Davidson, J.S. (2002). Effect of lidocaine and epinephrine on *Staphylococcus aureus* in a guinea pig model of surgical wound infection. *Plast. Reconstr. Surg.* **110**, 1275–1279.
- Strigo, I.A., Duncan, G.H., Bushnell, M.C., Boivin, M., Wainer, I., Rodriguez Rosas, M.E., and Persson, J. (2005). The effects of racemic ketamine on painful stimulation of skin and viscera in human subjects. *Pain* **113**, 255–264.
- Strobel, G.E., and Wollman, H. (1969). Pharmacology of anesthetic agents. *Fed. Proc.* **28**, 1386–1403.
- Sugiyama, K., and Muteki, T. (1994). Local anesthetics depress the calcium current of rat sensory neurons in culture. *Anesthesiology* **80**, 1369–1378.
- Sun, R., Hamilton, R.C., and Gimbel, H.V. (1999). Comparison of 4 topical anesthetic agents for effect and corneal toxicity in rabbits. *J. Cataract. Refract. Surg.* **25**, 1232–1236.
- Sutton, J.A. (1972). A brief history of steroid anaesthesia before Althesin (CT1341). *Postgrad. Med. J. Suppl.* **2**, 9–13.
- Suzdak, P.D., Schwartz, R.D., Skolnick, P., and Paul, S.M. (1986). Ethanol stimulates g-aminobutyric acid receptor-mediated chloride transport in rat brain synaptosomes. *Proc. Natl. Acad. Sci. U.S.A.* **83**, 4071–4075.
- Svensen, P., and Carter, A.M. (1985). Influence of injectable anaesthetic combinations on blood gas tensions and acid-base status in laboratory rats. *Acta Pharmacol. Toxicol.* **57**, 1–7.
- Sylvina, T.J., Berman, N.G., and Fox, J.G. (1990). Effects of yohimbine on bradycardia and duration of recumbency in ketamine/xylazine anesthetized ferrets. *Lab. Anim. Sci.* **40**, 178–182.
- Taber, R., and Irwin, S. (1969). Anesthesia in the mouse. *Fed. Proc.* **28**, 1528–1532.
- Taie, S., Leichtweis, S.B., Liu, K.J., Miyake, M., Grinberg, O., Demidenko, E., and Swartz, H.M. (1999). Effects of ketamine/xylazine and pentobarbital anesthesia on cerebral tissue oxygen tension, blood pressure, and arterial blood gas in rats. *Adv. Exp. Med. Biol.* **471**, 189–198.
- Takahashi, Y., Yamato, K., Akiyama, H., Tsuji, K., Onishi, H., and Machida, Y. (2005). Transdermal absorption of propofol in rats. *Biol. Pharm. Bull.* **28**, 870–875.
- Takano, Y., and Yaksh, T.L. (1992). Characterization of the pharmacology of intrathecally administered α_2 agonists and antagonists in rats. *J. Pharmacol. Exp. Ther.* **261**, 764–772.
- Tan, P.C.P., Shyr, M.H., Yang, C.H., Kuo, T.B.J., Pan, W.H.T., and Chan, S.H.H. (1993). Power spectral analysis of the electroencephalographic and hemodynamic correlates of propofol anesthesia in the rat: Intravenous infusion. *Neuroscience* **160**, 205–208.
- Taniguchi, T., Kanakura, H., and Yamamoto, K. (2002). Effects of posttreatment with propofol on mortality and cytokine responses to endotoxin-induced shock in rats. *Crit. Care Med.* **30**, 904–907.
- Taniguchi, T., and Yamamoto, K. (2005). Anti-inflammatory effects of intravenous anesthetics on endotoxemia. *Mini Rev. Med. Chem.* **5**, 241–245.
- Taniguchi, T., Yamamoto, K., Ohmoto, N., Ohta, K., and Kobayashi, T. (2000). Effects of propofol on hemodynamic and inflammatory responses to endotoxemia in rats. *Crit Care Med.* **28**, 1101–1106.
- Tarin, D., and Sturdee, A. (1972). Surgical anaesthesia of mice: Evaluation of tribromo-ethanol, ether, halothane and methoxyflurane and development of a reliable technique. *Lab. Anim.* **6**, 79–84.
- Taylor, J.M., Jenner, P.M., and Jones, W.I. (1964). A comparison of the toxicity of some allyl, propenyl, and propyl compounds in the rat. *Toxicol. Appl. Pharmacol.* **6**, 378–387.
- Taylor R., Hayes, K.E., and Toth, L.A. (2000). Evaluation of an anesthetic regimen for retroorbital blood collection from mice. *Contemp. Top. Lab. Anim. Sci.* **39**, 14–17.
- Teske, R.H., and Carter, G.C. (1971). Effect of chloramphenicol on pentobarbital-induced anesthesia in dogs. *J. Am. Vet. Med. Assoc.* **159**, 777–780.
- The Merck Index, 9th ed. (1976). pp 1234–1235. Merck and Co., Rahway, NJ.
- Thompson, J.S., Brown, S.A., Khurdayan, V., Zeynalzadedan, A., Sullivan, P.G., and Scheff, S.W. (2002). Early effects of tribromoethanol, ketamine/xylazine, pentobarbital, and isoflurane anesthesia on hepatic and lymphoid tissue in ICR mice. *Comp. Med.* **52**, 63–67.
- Thurmon, J.C. (1985). Comparative pharmacokinetics of selected injectable anesthetic agents. *Proc. 2nd Intl. Cong. Vet. Anes.* 21–26.
- Thurmon, J.C., and Benson, G.J. (1987). Pharmacologic considerations in selection of anesthetics for animals. *J. Am. Vet. Med. Assoc.* **191**, 1245–1251.
- Thurmon, J.C., Tranquilli, W.J., and Benson, G.J. (1992). α_2 -antagonists: Use in domestic and wild animal species. In "Animal Pain." (C.E. Short and A. Van Poznak, eds.), pp 237–247. Churchill Livingstone, New York.
- Thurmon, J.C., Tranquilli, W.J., and Benson, G.J. (1996). "Lumb and Jones' Veterinary Anesthesia," 3rd ed. Lippincott Williams and Wilkins, New York.

- Thurmon, J.C., Tranquilli, W.J., and Benson, G.J. (1999). "Essentials of Small Animal Anesthesia and Analgesia." Lippincott Williams and Wilkins, Philadelphia, PA.
- Tian, J., Chau, C., Hales, T.G., and Kaufman, D.L. (1999). GABA(A) receptors mediate inhibition of T cell responses. *J. Neuroimmunol.* **96**, 21–28.
- Ting, C.H., Arnott, R.H., Linkens, D.A., and Angel, A. (2004). Migrating from target-controlled infusion to closed-loop control in general anaesthesia. *Comput. Methods Programs Biomed.* **75**, 127–139.
- Tobias, K.M., Marioni-Henry, K., and Wagner, R. (2006). A retrospective study on the use of acepromazine maleate in dogs with seizures. *J. Am. Anim. Hosp. Assoc.* **42**, 283–289.
- Tobin, T., and Ballard S. (1979). Pharmacological review—The phenothiazine tranquilizers. *J. Equine Med. Surg.* **3**, 460–466.
- Tomemori, N., Shingu, K., Komatsu, T., Urabe, N., and Mori, K. (1981). Antianalgesic action of thiamylal sodium in cats. *Acta. Anaesthesiol. Scand. Suppl.* **25**, 523–525.
- Traber, D.L., Wilson, R.D., Priano, L.L. (1970). Blockade of the hypertensive effect to ketamine. *Anesth. Analg.* **49**, 420–426.
- Tracy, C.H., Short, C.E., and Clark, B.C. (1988). Comparing the effects of intravenous and intramuscular administration of Telazol. *Vet. Med.* (Jan.), 104–111.
- Tranquilli, W.J., Thurmon, J.C., and Benson, G.J. (1983). Organ blood flow and distribution of cardiac output in hypocapnic ketamine-anesthetized swine. *Am. J. Vet. Res.* **44**, 1578–1582.
- Tsai, S.K., and Lee, C. (1989). Ketamine potentiates nondepolarizing neuromuscular relaxants in a primate. *Anesth. Analg.* **68**, 5–8.
- Tuma, R.F., Irion, G.L., Vasthare, U.S., and Heinel, L.A. (1985). Age-related changes in regional blood flow in the rat. *Am. J. Physiol.* **249**(3 Pt. 2), H485–H491.
- Turner, D.M., Ransom, R.W., Yang, J.S.-J., and Olsen, R.W. (1989). Steroid anesthetics and naturally occurring analogs modulate the g-aminobutyric acid receptor complex at a site distinct from barbiturates. *J. Pharmacol. Exp. Ther.* **248**, 960–966.
- Turner, T.T., and Howards, S.S. (1977). Hyperglycemia in the hamster anesthetized with Inactin®[5-ethyl-5-(1-methyl propyl)-2-thiobarbiturate]. *Lab. Anim. Sci.* **27**, 380–382.
- Ungemach, F.R., Heinritz, K., Kersjes, C.M., and Erhardt, W. (1997). Ban of the use of metomidate (Hypnodil) in swine. Background, consequences and alternatives. *Tierarztl. Prax. Ausg. G. Grosstiere. Nutztiere.* **25**, 417–423.
- Usenik, E.A., and Cronkite, E.P. (1965). Effects of barbiturate anesthetics on leukocytes in normal and splenectomized dogs. *Anesth. Analg.* **44**, 167–170.
- Vachon, P., Faubert, S., Blais, D., Comtois, A., and Bienvenu, J.G. (2000). A pathophysiological study of abdominal organs following intraperitoneal injections of chloral hydrate in rats: Comparison between two anaesthesia protocols. *Lab. Anim.* **34**, 84–90.
- Vainio, O. (1989). Introduction to the clinical pharmacology of medetomidine. *Acta Vet. Scand.* **85**(Suppl.), 85–88.
- Vainio, O. (1990). Reversal of medetomidine-induced cardiovascular and respiratory changes with atipamezole in dogs. *Vet. Rec.* **127**, 447–450.
- Vainio, O. (1992). Pain control with medetomidine in dogs, cats, and laboratory animals. In "Animal Pain." (C.E. Short and A. Van Poznak, eds.), pp 213–219. Churchill Livingstone, New York.
- Van Der Meer, C., Versluys-Broers, J.A.M., Tuynman, H.A.R.E., and Buur, V.A. (1975). The effect of ethylurethane on hematocrit, blood pressure and plasma-glucose. *Arch. Int. Pharmacodyn. Ther.* **217**, 257–275.
- Van Leeuwen, A.F., Evans, R.G., and Ludbrook, J. (1990). Effects of halothane, ketamine, propofol and alfentanil anaesthesia on circulatory control in rabbits. *Clin. Exp. Pharmacol. Physiol.* **17**, 781–798.
- Vasseur, P.B., Paul, H.A., Dybdal, N., and Crumley, L. (1984). Effects of local anesthetics on healing of abdominal wounds in rabbits. *Am. J. Vet. Res.* **45**, 2385–2388.
- Vatner, S.F., Higgins, C.B., Patrick, T., Franklin, D., and Braunwald, E. (1971). Effects of cardiac depression and of anesthesia on the myocardial action of a cardiac glycoside. *J. Clin. Invest.* **50**, 2585–2595.
- Veenman, L., and Gavish, M. (2006). The peripheral-type benzodiazepine receptor and the cardiovascular system. Implications for drug development. *Pharmacol Ther.* **110**, 503–524. Epub 2005 Dec 7.
- Venn, R.M., Bryant, A., Hall, G.M., and Grounds, R.M. (2001). Effects of dexmedetomidine on adrenocortical function, and the cardiovascular, endocrine and inflammatory responses in post-operative patients needing sedation in the intensive care unit. *Br. J. Anaesth.* **86**, 650–656.
- Venugopalan, C.S., Holmes, E.P., Fucci, V., Keefe, T.J., and Crawford, M.P. (1994). Cardiopulmonary effects of medetomidine in heartworm-infected and noninfected dogs. *Am. J. Vet. Res.* **55**, 1148–1152.
- Vesell, E.S. (1968). Factors affecting the responsiveness of mice to hexobarbital. *Pharmacology* **1**, 81–97.
- Virtanen, R. (1986). Pharmacology of detomidine and other α_2 -adrenoceptor agonists in the brain. *Acta Vet. Scand.* **82**(Suppl.), 35–46.
- Virtanen, R. (1989). Pharmacological profiles of medetomidine and its antagonist, atipamezole. *Acta Vet. Scand.* **85**(Suppl.), 29–37.
- Volicer, L., and Loew, C.G. (1971). The effect of urethane anesthesia on the cardiovascular action of angiotensin II. *Pharmacology* **6**, 193–201.
- Wafford, K.A., Macaulay, A.J., Fradley, R., O'Meara, G.F., Reynolds, D.S., and Rosahl, T.W. (2004). Differentiating the role of gamma-aminobutyric acid type A (GABAA) receptor subtypes. *Biochem. Soc. Trans.* **32**, 553–556.
- Wagner, K.A., Gibbon, K.J., Strom, T.L., Kurian, J.R., and Trepanier, L.A. (2006). Adverse effects of EMLA (lidocaine/prilocaine) cream and efficacy for the placement of jugular catheters in hospitalized cats. *J. Feline Med. Surg.* **8**, 141–144. Epub 2005 Dec 27.
- Walker, L.A., Buscemi-Bergin, M., and Gellai, M. (1983). Renal hemodynamics in conscious rats: Effects of anesthesia, surgery, and recovery. *Am. J. Physiol.* **245**, F67–F74.
- Walker, L.A., Gellai, M., and Valtin, H. (1986). Renal response to pentobarbital anesthesia in rats: Effect of interrupting the renin-angiotensin system. *J. Pharmacol. Exp. Ther.* **236**, 721–728.
- Wang, Y., Zhou, T., Chua, T.C., and Pang, C.C.Y. (1991). Effects of inhalation and intravenous anaesthetic agents on pressor response to NG-nitro-L-arginine. *Eur. J. Pharmacol.* **198**, 183–188.
- Ward, G.S., Johnson, D.O., and Roberts, C.R. (1974). The use of CI 744 as an anesthetic for laboratory animals. *Lab. Anim. Sci.* **24**, 737–742.
- Waterman, A.E. (1983). Influence of premedication with xylazine on the distribution and metabolism of intramuscularly administered ketamine in cats. *Res. Vet. Sci.* **35**, 285–290.
- Waterman, A.E. (1984). The pharmacokinetics of ketamine administered intravenously in calves and the modifying effect of premedication with xylazine hydrochloride. *J. Vet. Pharmacol. Ther.* **7**, 125–130.
- Waterman, A.E., and Livingston, A. (1978). Effects of age and sex on ketamine anaesthesia in the rat. *Br. J. Anaesth.* **50**, 885–889.
- Watney, G.C., and Pablo, L.S. (1992). Median effective dosage of propofol for induction of anesthesia in dogs. *Am. J. Vet. Res.* **53**, 2320–2322.
- Way, W.L., and Trevor, A.J. (1986). Pharmacology of intravenous nonnarcotic anesthetics. In "Anesthesia." (R.D. Miller, ed.), 2nd ed., pp 799–833. Churchill Livingstone, New York.
- Weiland, L., Croubels, S., Baert, K., Polis, I., De Backer, P., and Gasthuys, F.J. (2006). Pharmacokinetics of a lidocaine patch 5% in dogs. *Vet. Med. A Physiol. Pathol. Clin. Med.* **53**, 34–39.
- Welberg, L.A.M., Kinkad, B., Thirvikraman, K.V., Huerkamp, M.J., Nemeroff, C.B., and Plotsky, P.M. (2006). Ketamine–xylazine–acepromazine anesthesia and postoperative recovery in rats. *J. Am. Assoc. Lab. Anim. Sci.* **45**, 13–20.
- Wertz, E.M., Benson, G.J., Thurmon, J.C., Tranquilli, W.J., Davis, L.E., and Koritz, G.D. (1988). Pharmacokinetics of thiamylal in cats. *Am. J. Vet. Res.* **49**, 1079–1083.
- Wertz, E.M., Benson, G.J., Thurmon, J.C., Tranquilli, W.J., Davis, L.E., and Koritz, G.D. (1990). Pharmacokinetics of etomidate in cats. *Am. J. Vet. Res.* **51**, 281–285.
- West, C.D., and Green, C.J. (1987). The sedative effects of climazolam and climazolam with fentanyl–fluanisone in rats (*Rattus norvegicus*). *Lab. Anim.* **21**, 143–148.

- Westenberg, I.S., and Bolam, J.M. (1981). Lethal doses of pentobarbital sodium in albino versus pigmented rats: A within-strain comparison. *Lab. Anim. Sci.* **31**, 360–361.
- Westfall, B.A., Boulos, B.M., Shields, J.L., and Garb, S. (1964). Sex differences in pentobarbital sensitivity in mice. *Proc. Soc. Exp. Biol. Med.* **115**, 509–510.
- Wheaton, L.G., Benson, G.J., Tranquilli, W.J., and Thurmon, J.C. (1989). The oxytocic effect of xylazine on the canine uterus. *Theriogenology* **31**, 911–915.
- Whelan, G., and Flecknell, P.A. (1992). The assessment of depth of anaesthesia in animals and man. *Lab. Anim.* **26**, 153–162.
- White, P.F. (1989). Clinical uses of intravenous anesthetic and analgesic infusions. *Anesth. Analg.* **68**, 161–171.
- Wilder, R.T., Sholas, M.G., and Berde, C.B. (1996). NG-nitro-L-arginine methyl ester (L-NAME) prevents tachyphylaxis to local anesthetics in a dose-dependent manner. *Anesth. Analg.* **83**, 1251–1255.
- Winter, L., Nadeson, R., Tucker, A.P., and Goodchild, C.S. (2003). Antinociceptive properties of neurosteroids: A comparison of alphadolone and alphaxalone in potentiation of opioid antinociception. *Anesth. Analg.* **97**, 798–805.
- Wixson, S.K., and Smiler, K.L. (1997). Anesthesia and analgesia in rodents. In "Anesthesia and Analgesia in Laboratory Animals." (D.F. Kohn, S.K. Wixson, W.J. White, and G.J. Benson, eds.), pp 165–203. Academic Press, San Diego, CA.
- Wixson, S.K., White, W.J., Hughes, H.C., Jr., Lang, C.M., and Marshall, W.K. (1987a). A comparison of pentobarbital, fentanyl–droperidol, ketamine–xylazine and ketamine–diazepam anesthesia in adult male rats. *Lab. Anim. Sci.* **37**, 726–730.
- Wixson, S.K., White, W.J., Hughes, H.C., Jr., Marshall, W.K., and Lang, C.M. (1987b). The effects of pentobarbital, fentanyl–droperidol, ketamine–xylazine and ketamine–diazepam on noxious stimulus perception in adult male rats. *Lab. Anim. Sci.* **37**, 731–735.
- Wixson, S.K., White, W.J., Hughes, H.C., Jr., Lang, C.M., and Marshall, W.K. (1987c). The effects of pentobarbital, fentanyl–droperidol, ketamine–xylazine and ketamine–diazepam on arterial blood pH, blood gases, mean arterial blood pressure and heart rate in adult male rats. *Lab. Anim. Sci.* **37**, 736–742.
- Wixson, S.K., White, W.J., Hughes, H.C., Jr., Lang, C.M., and Marshall, W.K. (1987d). The effects of pentobarbital, fentanyl–droperidol, ketamine–xylazine and ketamine–diazepam on core and surface body temperature regulation in adult male rats. *Lab. Anim. Sci.* **37**, 743–749.
- Wright, M. (1982). Pharmacologic effects of ketamine and its use in veterinary medicine. *J. Am. Vet. Med. Assoc.* **180**, 1462–1471.
- Yamashita, A., Matsumoto, M., Matsumoto, S., Itoh, M., Kawai, K., and Sakabe, T. (2003). A comparison of the neurotoxic effects on the spinal cord of tetracaine, lidocaine, bupivacaine, and ropivacaine administered intrathecally in rabbits. *Anesth. Analg.* **97**, 512–519.
- Yamazaki, T., and Sagawa, K. (1984). Effect of thiamylal on the response to carotid occlusion and mild hemorrhage in rabbits. *Am. J. Physiol.* **246**, H806–H810.
- Yang, F.L., Li, C.H., Hsu, B.G., Tsai, N.M., Lin, S.Z., Harn, H.J., Chen, H.I., Liao, K.W., and Lee, R.P. (2007). The reduction of tumor necrosis factor-alpha release and tissue damage by pentobarbital in the experimental endotoxemia model. *Shock* **28**, 309–316.
- Yang, H., Wong, H., Wu, V., Walsh, J.H., and Taché, Y. (1990). Somatostatin monoclonal antibody immunoneutralization increases gastrin and gastric acid secretion in urethane-anesthetized rats. *Gastroenterology* **99**, 659–665.
- Yang, X.P., Liu, Y.H., Rhaleb, N.E., Kurihara, N., Kim, H.E., and Carretero, O.A. (1999). Echocardiographic assessment of cardiac function in conscious and anesthetized mice. *Am. J. Physiol.* **277**(5 Pt. 2), H1967–H1974.
- Yelnosky, J., Katz, R., and Dietrich, E.V. (1964). A study of some of the pharmacologic actions of droperidol. *Toxicol. Appl. Pharmacol.* **6**, 37–47.
- Yokoyama, M., Hirakawa, M., and Goto, H. (1995). Effect of vasoconstrictive agents added to lidocaine on intravenous lidocaine-induced convulsions in rats. *Anesthesiology* **82**, 574–580.
- Ypsilantis, P., Mikroulis, D., Politou, M., Tsoukali, H., Pitiakoudis, M., Didilis, V., Theodoridis, G., Bougioukas, G., and Simopoulos, C. (2006). Tolerance to propofol's sedative effect in mechanically ventilated rabbits. *Anesth. Analg.* **103**, 359–365.
- Zaugg, M., Lucchinetti, E., Spahn, D.R., Pasch, T., Garcia, C., and Schaub, M.C. (2002). Differential effects of anesthetics on mitochondrial K(ATP) channel activity and cardiomyocyte protection. *Anesthesiology* **97**, 15–23.
- Zavala, F. (1997). Benzodiazepines, anxiety and immunity. *Pharmacol. Ther.* **75**, 199–216.
- Zeller, W., Meier, G., Burki, K., and Panoussis, B. (1998). Adverse effects of tribromoethanol as used in the production of transgenic mice. *Lab. Anim.* **32**, 407–413.
- Zhou, W., Fontenot, H.J., Wang, S.N., and Kennedy, R.H. (1999). Propofol-induced alterations in myocardial beta-adrenoceptor binding and responsiveness. *Anesth. Analg.* **89**, 604–608.
- Zimpfer, M., Manders, W.T., Barger, A.C., and Vatner, S.F. (1982). Pentobarbital alters compensatory neural and humoral mechanisms in response to hemorrhage. *Am. J. Physiol.* **243**, H713.
- Zimpfer, M., Sit, S.P., and Vatner, S.F. (1981). Effects of anesthesia on the canine carotid chemoreceptor reflex. *Circ. Res.* **48**, 400–406.
- Zink, W., and Graf, B.M. (2004). Local anesthetic myotoxicity. *Reg. Anesth. Pain Med.* **29**, 333–340.
- Zuurbier, C.J., Emons, V.M., and Ince, C. (2002). Hemodynamics of anesthetized ventilated mouse models: Aspects of anesthetics, fluid support, and strain. *Am. J. Physiol. Heart Circ. Physiol.* **282**, H2099–H2105.

Pharmacology of Inhalation Anesthetics

David B. Brunson

I. Introduction	83
II. Chemical and Physical Properties	84
A. Vapor Pressure	84
B. Molecular Weight and Vapor Pressure	85
C. Minimum Alveolar Concentration (MAC)	86
D. Boiling Point	88
E. Partition Coefficients	88
F. Stability	89
III. Mode of Action	89
IV. Uptake—Distribution—Elimination	89
V. Inhaled Anesthetics	90
A. Nitrous Oxide	90
B. Ether	90
C. Methoxyflurane	91
D. Halothane	91
E. Isoflurane	91
F. Enflurane	92
G. Sevoflurane and Desflurane	92
VI. Measurement and Qualification of Anesthetic Concentration for Research ..	92
A. Nonspecific Methods of Measurement	93
B. Specific Methods of Measurement	93
VII. Summary	94
References	94

I. INTRODUCTION

Originally, our knowledge of inhalation anesthetics was based on studies of ether, nitrous oxide (N₂O), and chloroform in animals. In the early 1960s, methoxyflurane (MOF) and halothane were introduced in the hope that side effects associated with

both ether and chloroform could be minimized. Although these drugs provided improvements over previous gas anesthetics, their clinical profiles were still associated with tissue toxicity. As the understanding of pharmacologic and physiologic effects of gas anesthetics increased, it became apparent that toxicity and safety fell short of the target of an ideal anesthetic. The

lower solubility and lessened depression of myocardial contractility lead to the introduction of both isoflurane and sevoflurane. Despite being useful in laboratory animal anesthesia, the use and hence the production of halothane and MOF was discontinued in the United States.

Currently, three potent inhalant anesthetics are routinely being used to anesthetize people. These are isoflurane, sevoflurane, and desflurane. N₂O is still administered as an adjunct to both inhalant and injectable anesthetics. Although an ideal gas anesthetic has not yet been discovered, the new potent inhalant anesthetics provide excellent options for a wide range of situations. Following are the characteristics of an ideal inhalant anesthetic (Jones, 1990).

1. Stable molecular structure: The compound should not be degradable on exposure to light, or reaction with alkali or soda lime. It should not require preservatives and should have a long shelf life.
2. Nonflammable and nonexplosive: It should be nonflammable when mixed with air, oxygen, or N₂O.
3. High potency: It should be easily delivered so that high concentrations of oxygen can be administered simultaneously during anesthesia.
4. Low solubility in blood: Blood/gas solubility should be low in order that induction and emergence from anesthesia are rapid. This enables rapid and precise control of anesthetic depth.
5. Nonirritating: It should not cause irritation to the respiratory system, bronchospasm, or breath holding. Inductions should be smooth and rapid.
6. Not metabolized: High molecular stability is desired to eliminate toxic metabolites and effect of disease on drug elimination.
7. Cardiovascular and respiratory systems unaffected: The anesthetic should not cause depression of myocardial contractility or induce arrhythmias. It should not induce sensitization to catecholamines, and ventilatory rate and tidal volume should remain unchanged.
8. Central nervous system (CNS) effects reversible and non-stimulatory: Cerebral blood flow should either remain unchanged or decrease during the inhaled anesthesia.
9. Compatible with other drugs: The ideal inhalant anesthetic should be compatible with all other medications, especially other cardiovascular supportive drugs.
10. Easily delivered: Vaporization and potency should be such that it facilitates delivery of effective concentrations without limiting the inspired oxygen concentrations. Delivery through open systems or precision vaporizers should be possible.
11. Affordable: The cost of manufacturing the drug and appropriate delivery systems must allow a low cost per hour of anesthesia.

Although injectable anesthetic techniques have been developed and widely used for all animal species, inhalation anesthesia

offers important advantages and hence proves to be the most appropriate method for general anesthesia. From a research standpoint, it is important that all animals are maintained at reproducible levels of anesthesia, which can be accurately measured, and the effects of the anesthetic determined when comparing data.

The most important advantage of inhaled anesthetics for research is that the concentrations can be measured on a continual basis, which ensures that all animals are at a similar anesthetic depth. This is important because anesthetic effects vary with the depth of anesthesia. Since gas anesthetics are delivered continuously via the lungs, during normal ventilation/perfusion exchange states, alveolar anesthetic concentrations will closely approximate the arterial blood concentrations. Tissues such as the brain, which have high blood flows, equilibrate rapidly with the arterial blood. By measuring the end tidal gas anesthetic concentration, the depth of anesthesia can be compared throughout the anesthetic period. A number of animals can thus be studied under the same anesthetic conditions.

In contrast, injectable anesthetic concentrations are difficult to measure and stable blood concentrations are not easily confirmed. Absorption, distribution, and elimination of drugs injected intravenously, intramuscularly, subcutaneously, and intraperitoneally result in comparisons of the anesthetic depth based on subjective observations that do not correlate with the actual drug concentrations in blood (Morris et al., 1979). Injectable anesthetic techniques may be preferred when waste gas elimination is not practical, gas anesthetic delivery is not possible, and precise control of the anesthetic level is not needed.

II. CHEMICAL AND PHYSICAL PROPERTIES

The physical and chemical properties of the major inhaled anesthetics are shown in Table 3-1. Although no longer recommended as an anesthetic for research, ether is included for comparison with the modern potent inhaled anesthetics. Desflurane and sevoflurane are new potent inhalant anesthetics, which have unique chemical and physical properties.

A. Vapor Pressure

The vapor pressure is a measure of the volatility of the drug and is defined as the maximum pressure that can be produced by the anesthetic at a given temperature and pressure. Vapor pressure divided by the atmospheric pressure gives the maximal fraction of anesthetic vapor that can be produced. In the case of isoflurane, the vapor pressure is 239.5 at 20°C. If used at sea level where the barometric pressure is 760 mmHg, the maximal concentration that can be produced would be 0.3186 or 31.86%. Thus, in the presence of liquid anesthetic in a container (bottle,

TABLE 3-1
CHEMICAL AND PHYSICAL PROPERTIES OF INHALANT ANESTHETICS

Property	Ether	Methoxyflurane	Halothane	Isoflurane	Enflurane	Desflurane	Sevoflurane	Nitrous oxide
Formula	CH ₃ OCH ₃	CHCl ₂ CF ₂ OCH ₃	CHClBrCF ₃	CF ₃ CHClOCF ₂ H	CHF ₂ CF ₂ OCHF ₂	CH ₂ HOCF ₂ CF ₃	CFH ₂ OCH(CF ₃) ₂	N ₂ O
Molecular weight	74	165.0	197.4	184.5	184.5	168.0	200.1	44
Specific gravity	0.71	1.65	1.87	1.50	1.52	1.46	1.52	1.23
Boiling point	36.5	104.7	0.2	48.5	56.5	23.5	58.5	-89
Vapor pressure at 20°C	450	22.8	244.1	239.5	171.8	664	159.9	39,500
Maximum percent concentration	49	3%	32.53	31.86	22.93	88.53	21.33	100
MAC (dog)	3.04%	0.23%	0.87%	1.28%	2.2%	7.2%	2.36%	188%
Odor	Ethereal	Fruity	Organic solvent	Pungent ethereal	Ethereal	Pungent ethereal	Mild	Sweet
Stability		>50%	20%	0.2%	20%	<0.2%	~2.0%	
Explosive	>1.8% in air >2.1% in O ₂	No	No	No	No	No	No	
Preservatives	Yes, 3% ethanol	Yes, 0.01% hydrated hydrotoluene	Yes, thymol	None	None	None	None	None

vaporizer, anesthetic chamber), this indicates that the partial pressure (concentration) of the anesthetic is at the maximum level (i.e. the vapor pressure). Since isoflurane and sevoflurane are highly potent and have low blood:gas solubility, delivery of uncontrolled inspired concentrations is unsafe.

Precision vaporizers are designed to mix the correct volume of dilution gas and anesthetic vapor to produce a clinically useable concentration (Dorsch and Dorsch, 1998). Oxygen alone or combined with N₂O is mixed with anesthetic vapors to deliver a concentration that is high enough to anesthetize the animal but low enough to prevent rapid anesthetic overdose. Anesthetics such as halothane and isoflurane, which have nearly similar boiling points and vapor pressures, can be used in identically manufactured vaporizers (Steffey et al., 1983). However, the practice of using an anesthetic in a vaporizer, which is not designed for that particular anesthetic, is not recommended. Extreme care must be taken to prevent mixing of volatile anesthetics in the same vaporizer. Accidental cross filling of vaporizers can result in unknown delivered concentrations of both gases. The practice of changing anesthetic drugs in vaporizers can easily result in misidentification of the contents of the vaporizer. Vaporizers should always be clearly labeled and only contain the designated anesthetic (Dorsch and Dorsch, 1998).

B. Molecular Weight and Vapor Pressure

All the inhaled anesthetics have molecular weights between 165.0 and 200.1, with the exception of N₂O and ether (Table 3-1). Because of this fact the amount of vapor produced (in milliliters) by 1 ml of liquid anesthetic is also similar

TABLE 3-2

MILLILITERS OF GAS ANESTHETIC FORMED FROM
VAPORIZATION OF 1 ML OF LIQUID ANESTHETIC

Methoxyflurane	191.4 ml
Isoflurane	182.1 ml
Sevoflurane	170.0 ml

Calculated at standard temperature (273 K) and pressure (760 mmHg).

(Table 3-2). The volume of gaseous anesthetic formed from 1 ml of liquid anesthetic can be calculated using the gas laws (Linde, 1971):

$$PV = nRT$$

$$V = nRT/P$$

where the volume of gas formed from 1 ml of liquid is equal to the number of moles of the liquid (density divided by the molecular weight) times the gas constant ($R = 0.082 \text{ ml} \times \text{atm}/\text{K} \times \text{mole}$) times the temperature in K divided by number of atmospheres of pressure (atm). Direct injection of liquid anesthetic into closed delivery systems can be successfully performed using volatile anesthetic, by calculating the volume of anesthetic required to produce a desired concentration in the anesthetic system. Similarly, anesthetic chambers can be used without precision vaporizers if the volume of the system is known and the volume of liquid anesthetic needed to produce the desired concentration is calculated. Table 3-3a-c provide the number of milliliters of liquid anesthetic needed to produce anesthetic concentrations in the clinically useable

TABLE 3-3

THE FOLLOWING CALCULATED VOLUMES OF LIQUID ISOFLURANE, SEVOFLURANE, AND METHOXYFLURANE INJECTED INTO CONTAINERS OF CORRESPONDING VOLUMES WILL PRODUCE A FINAL GAS CONCENTRATION IN THE CLINICAL USEABLE RANGE. INCLUDE DESCRIPTIVE TITLE

Percent	Internal volume of anesthetic chamber (ml)				
	1,000	2,000	3,000	4,000	5,000
(a) isoflurane					
1	0.05	0.10	0.15	0.20	0.26
2	0.10	0.20	0.31	0.41	0.51
3	0.15	0.31	0.46	0.61	0.77
4	0.20	0.41	0.61	0.82	1.02
5	0.26	0.51	0.77	1.02	1.28
(b) Sevoflurane					
1	0.05	0.11	0.16	0.22	0.27
2	0.11	0.22	0.33	0.44	0.55
3	0.16	0.33	0.49	0.66	0.82
4	0.22	0.44	0.66	0.88	1.10
5	0.27	0.55	0.82	1.10	1.37
6	0.33	0.66	0.99	1.32	1.65
(c) Methoxyflurane					
1	0.05	0.10	0.15	0.19	0.24
2	0.10	0.19	0.29	0.39	0.49
3	0.15	0.29	0.44	0.58	0.73

Calculations at 20°C and 760 mmHg.

range. This facilitate the use of anesthetic concentrations that produce safe anesthesia with even highly volatile anesthetics such as isoflurane and sevoflurane. However, uncontrolled delivery of volatile anesthetic gases is not recommended it is unsafe and there are chances of errors in calculations. A precision vaporizer should be used to accurately deliver a known anesthetic concentration to the animal whenever possible.

Laboratory animals are frequently anesthetized in bell jars or anesthetic chambers. For many years, ether was used in this manner without any concern for the inspired concentration. The high vapor pressure of ether produces maximum anesthetic partial pressures of 450 mmHg, which is equal to an inspired concentration of 59% (Price, 1975). Ether can be delivered without the need for controlling the inspired concentration for two reasons. First, the effective dose to produce anesthesia in half of the animals [minimum alveolar concentration (MAC)] is 1.9%; because of the low potency, a high inspired concentration is desirable. Second, ether has a high blood/gas solubility and thus the equilibration is relatively slow, providing a longer time period when overdosage can be prevented by removing the animal from the chamber.

Although currently it is not commercially available in North America, MOF was frequently used for chamber inductions, but without precise control of the inspired concentration for similar reasons as in the case of ether. Like ether, it has a high blood/gas solubility that results in a long equilibration time. However, MOF is a very potent inhalant anesthetic with a MAC

value of 0.23%. Once equilibration has occurred, very little MOF is required for the maintenance of the anesthetic level. Unlike ether, MOF has a low volatility that limits the maximum concentration that can be produced at room temperature to 3%. The slow equilibration and the low volatility balance the high potency to make MOF useable without precise control of the inspired concentration.

All of the remaining potent inhaled anesthetics require control of the inspired concentration to be used safely. They possess high volatility, low blood/gas solubility, and relatively high potency. Together these factors result in rapid equilibration and greater potential for overdose.

C. Minimum Alveolar Concentration (MAC)

The MAC is the concentration at 1 atm that produces immobility in 50% of animals exposed to a noxious stimulus (Eger, 1974). Thus, MAC is synonymous with the effective dose or ED50 and is a measure of the potency of inhaled anesthetics. MAC values can be determined as the concentration at which either 50% of a group of animals respond, or an individual animal responds 50% of the time, to a standardized noxious stimulus.

MAC is important for three reasons. First, it is a measure of the effectiveness of inhalation anesthetics in the context of clinical use. General anesthesia is defined as the loss of pain perception, reflex, and spontaneous muscle activity. To be properly anesthetized, an animal must be immobile and unaware of noxious (painful) stimuli. These factors are the end points used to determine MAC. Second, MAC can be applied to all inhalation anesthetics. MAC is important because it allows direct comparisons for a number of animals or sequential anesthetic episodes, ensuring that they are performed at the same depth of anesthesia. The ability to measure end tidal anesthetic concentrations on a breath-to-breath basis ensures that each animal is at approximately the same magnitude of anesthetic compromise. Third, MAC is important because continuous monitoring of alveolar concentrations helps in maintaining the animal at a known and stable depth of anesthesia.

1. Determination of MAC

The standard bracketing procedures for MAC determination are as follows. When possible the animals should be anesthetized, via a mask or chamber, with only the inhalational anesthetic. Sedatives and injectable anesthetics can affect the required inhalational anesthetic concentration needed to cause immobility. The concentration of the anesthetic is measured and held constant for at least 15 minutes to ensure equilibration between the alveoli and the brain. Measurements done at the end of expiration provide the most accurate estimate of the anesthetic concentration in the blood leaving the lungs. A noxious stimulus is then applied and the animal is monitored for

gross purposeful movement or the absence of movement. During MAC determinations, stretching, increased ventilation, or spontaneous movement are not considered as an indicator of movement. Classically, either a large hemostat is clamped to the animal's tail or digits (usually for 1 minute) or the passage of an electrical current through subcutaneous tissue is used as the noxious stimulus (Quasha et al., 1980). If no response is observed, the alveolar concentration is reduced by 20% of the previous setting, and after a lapse of 15 minutes for equilibration, the stimulus is repeated. The step-down procedure is continued until gross purposeful movement is observed in response to the noxious stimulus. The alveolar concentration is then increased by 10% until the animal fails to respond to the noxious stimulus. The MAC (ED50) is the concentration half way between the concentrations where the animal responds and does not respond.

The use of alveolar anesthetic concentration as a measurement of the animal's anesthetic level is based on the assumption that gases within the alveoli are in equilibrium with the blood exiting the lung. Arterial blood is assumed to be in equilibrium with tissues with high blood flow, such as the brain. These assumptions are true as long as ventilation and perfusion are closely matched and sufficient time has elapsed to allow equilibration between the alveolar gases and the pulmonary blood. Alveolar concentrations are assumed to represent the anesthetic concentration in the animal's brain. The anesthetic concentrations in the gases at the end of expiration (end tidal concentrations) are from the deepest areas of the pulmonary system (i.e. the alveoli). Normally ventilation and perfusion are equally matched in the lung, and alveolar gas is fully equilibrated with the blood. Ventilation/perfusion mismatching and shunting of blood past alveoli result in discrepancies between the alveolar anesthetic concentrations and the anesthetic concentrations in the blood and brain (Eger, 1974). This problem is uncommon in healthy mammals that weigh less than 50 kg, but occurs frequently in larger animals such as horses.

MAC has been shown to be remarkably consistent among a wide variety of animal species (Table 3-5), although Dohm and Brunson (1993) determined an isoflurane ED50 for a reptilian species (desert iguana) that was markedly higher than that for other species.

2. Factors that do not Alter MAC

There is less biological variability in MAC within an animal species, with all animals being affected within a narrow range. In a group of research dogs, the deviation from the group mean equaled 10–20% (Eger, 1974). Variation within individual animals is even less.

MAC is not affected by the type or the intensity of the stimulus (Jones, 1990). Suppression of movement during skin incision, tail clamp, and passage of electrical current all require the same alveolar concentrations (Eger, 1974). The duration of anesthesia does not alter MAC; the concentration required to suppress movement is constant from the beginning to the end of

a procedure. There is no sex-related difference in the potency of inhalational anesthetics (Quasha et al., 1980).

A change in acid–base status has little effect on MAC values. Infusions of sodium bicarbonate and hydrochloric acid to produce base excess of +7 and –20 mEq, respectively, does not alter MAC (Eger, 1974). Furthermore, when carbon dioxide (CO₂) is greater than 10 mmHg but below 90 mmHg, MAC is not changed. Hypoventilation resulting in CO₂ greater than 90 mmHg increased the anesthetic effect of halothane. It is believed that this effect is related to an increase in cerebrospinal fluid hydrogen ion concentration. Complete CO₂ narcosis occurs at a CSF pH of 6.8–6.9 (Eger, 1974).

MAC is not affected by changes in arterial oxygen partial pressures above 40 mmHg. When arterial partial pressure of oxygen (P_aO₂) drops below 40 mmHg, MAC decreases. Similarly when arterial oxygen content decreased below 5 ml/100 ml of blood due to anemia, MAC decreased to 1/3 of the original value. This is most likely related to the development of cerebral lactic acidosis during hypoxemia (Quasha et al., 1980).

Changes in blood pressure have no effect on the MAC values of inhalational anesthetics. Hypertension induced by phenylephrine did not alter MAC; however, severe hypotension secondary to hemorrhage did reduce halothane MAC. This was thought to be related to the concomitant hypoxia that occurred (Eger, 1974).

3. Factors that Alter MAC

MAC is affected by several factors. Small changes in MAC have been observed due to circadian rhythms in rats. Anesthesia during high-activity time periods results in higher MAC requirements than anesthesia during low-activity periods. Although there is only a 5–10% difference, anesthesia should be performed during similar-activity time periods to reduce variability (Quasha et al., 1980).

Anesthetic requirements decrease directly with decreases in the animal's body temperature. Halothane and MOF requirements decrease by 5% for each degree centigrade decrease; thus, animals allowed to cool during anesthesia will require less inhalational anesthetics than normothermic animals. Cooling of anesthetized animals occurs for numerous reasons. Animals lose heat due to moisture evaporation through the respiratory system during surgery and convective heat loss to the surgical table. In order to compare data from similar anesthetic preparations, animals must be maintained at a known temperature and the gas anesthetic concentration monitored. Decreased MAC is probably not due to altered metabolic rate, since increased metabolic rate associated with hyperthyroidism only slightly increased MAC requirements, but is associated with direct CNS depression associated with hypothermia (Eger, 1974; Quasha et al., 1980).

Age has been shown to affect the MAC requirements of animals (Quasha et al., 1980). Very old animals have lower MAC values. This may be due to lower neuronal density or a lower

cerebral metabolic rate. The highest MAC requirements occur in neonates. Animals of similar age should be used to minimize variations in sensitivity to inhalational anesthetics.

Synergistic effects are common between CNS depressant drugs and inhalational anesthetics. Opioids have been shown to reduce MAC (Curro et al., 1994; Eger, 1974). Even drugs such as diazepam reduce MAC in people even though the benzodiazepine drugs have no analgesic properties (Mathews et al., 1990).

Inhalational anesthetics have been shown to be additive and thus can be used in combinations to produce general anesthesia. N₂O is frequently used in animal anesthetic protocols to simulate human anesthetic techniques. Although highly volatile and highly potent anesthetics have been used together, they are usually administered as sole agents or in combination with N₂O.

CNS catecholamines and drugs which affect their release, can alter the MAC of inhalant anesthetics. Alpha methyl dopa and reserpine decrease MAC. D-amphetamine releases CNS catecholamines and increases MAC. Chronic administration can result in depletion of central catecholamines and a decreased MAC (Quasha et al., 1980).

D. Boiling Point

At room temperature all of the currently used inhalant anesthetics are liquids with the exception of N₂O. N₂O is supplied in cylinders that contain both liquid and gas; at pressures greater than 800 psi, N₂O is a liquid. Pressure gauges on N₂O cylinders will indicate a pressure of approximately 700 psi until all of the liquid N₂O has vaporized. The pressure will then progressively decrease until the cylinder is empty (Dorsch and Dorsch, 1998).

Desflurane has a unique physical-chemical property that causes it to boil at 23.5°C (room temperature) (Jones, 1990). Even small changes in temperature during vaporization produce uncontrollable changes in output; thus, the delivery of a constant known volume or concentration of desflurane becomes difficult. For this reason, desflurane requires a special vaporizer which can precisely control the vaporization temperature (Jones, 1990). Standard "Tec-type" or plenum vaporizers should not be used for desflurane.

E. Partition Coefficients

Solubility of inhaled anesthetics in blood and tissue provides an indication of the capacity of these compartments to hold anesthetic (Eger, 1985). These partition coefficients are expressed as ratios of the amounts of the anesthetic in the two compartments at equilibrium. The most important partition coefficient for inhaled anesthetics is the blood/gas partition coefficient (Table 3-4). Since blood is the first compartment to equilibrate with alveolar anesthetic gases, the blood/gas coefficient is an indication of the speed of onset. All other factors being equal,

TABLE 3-4
BLOOD/GAS AND OIL/BLOOD PARTITION COEFFICIENTS

Anesthetic	Blood/gas coefficient	Olive oil/blood
Ether	2.8	58.0
Methoxyflurane	12.0	970.0
Halothane	2.54	224.0
Isoflurane	1.46	91.0
Enflurane	2.0	96.0
Desflurane	0.42	19.0
Sevoflurane	0.69	53.0
Nitrous oxide	0.47	1.4

From Eger (1974); Jones (1990).

the greater the solubility of the anesthetic gas in blood the longer the equilibration time. Although solubility varies among tissues, tissue components, temperature, and species (Table 3-4), partition coefficients provide a consistent guideline for predicting how uptake and elimination will occur when comparing anesthetics (Wollman and Smith, 1975).

The primary objective of inhalant anesthesia is to produce a constant and sufficient partial pressure of the anesthetic in the brain to produce analgesia and unconsciousness. The vessel-rich group of tissues, which includes the brain (approximately 9% of the body weight), receives approximately 75% of the cardiac output (Eger, 1964). Because of the large blood flow to this small compartment, equilibration rapidly occurs between the anesthetic concentration in the blood and the brain. N₂O, desflurane, and sevoflurane have exceptionally low blood/gas solubilities and are associated with rapid uptake and elimination (Eger, 1992; Jones, 1990).

Rapid effects of insoluble anesthetics are further accentuated in very small animals. Smaller animals have correspondingly small lung, blood, and tissue volumes, which equilibrate very rapidly. In comparison to small-sized animals, large animals reach equilibrium at a slow rate even when insoluble anesthetics are administered (Steffey, 1978).

Tissue/blood partition coefficients also influence the anesthetic uptake. However, tissue solubility is more important during elimination of the inhaled anesthetics. Anesthetics with high lipid solubilities accumulate in fat tissue during anesthesia. Upon recovery, the anesthetic leaves the fat tissue and slows the animal's return to consciousness (Table 3-4). Lipid solubility and potency seemingly have a reciprocal relationship, which has led to the theory ("Unitary Theory") that the mode of action of gas anesthetics is related to a relatively constant number of anesthetic molecules dissolved in a hydrophobic phase (Kaufman, 1977). (See below for additional discussion of inhalant anesthetic mechanism of action.)

The solubility of anesthetic gases in the delivery apparatus also can affect uptake and elimination. Absorption of anesthetic into rubber or plastic components of the anesthetic delivery apparatus slows the inhalation process and hence induction. Uptake of anesthetic molecules by the anesthetic device also

affects recovery. Animals breathing from the anesthetic device continue to receive anesthetic released from rubber and/or plastic components even after the vaporizer has been turned off (Eger, 1974). Because isoflurane and sevoflurane have low rubber and plastic solubilities, uptake by the machine components is insignificant during induction and recovery from anesthesia.

F. Stability

Molecular stability is closely correlated with the lack of tissue toxicity. Inhalant anesthetics are not considered to be directly toxic to the body tissues. It is the metabolites of the anesthetics that cause tissue injury. Much of the effort to identify new inhalant anesthetics has been motivated by the need for less toxic anesthetics. Substitution of fluoride and bromide for chlorine has resulted in greater molecular stability and less toxic anesthetics. The level of biodegradation for various anesthetics is as follows: isoflurane, 0.2% (Holaday and Smith, 1981) of the administered dose; sevoflurane, approximately 2.0%; halothane, 20%; and MOF, more than 50% (Carpenter et al., 1986). The low rate of biodegradation of isoflurane, sevoflurane, and desflurane has resulted in decreased potential for renal and hepatic injury in the animals anesthetized, as well as in the personnel exposed to trace anesthetic levels (Njoku et al., 1997) (Table 3-5).

Molecular stability is also important as it relates to the need for preservatives. Ether, MOF, and halothane require addition of preservatives to prevent degradation during storage. Thymol was added to halothane as a preservative since it did not vaporize; it accumulated in the vaporizer and caused the turnstiles to stick. The accuracy of the vaporizer may be affected, which requires periodic servicing (Dorsch and Dorsch, 1998). Isoflurane, enflurane, desflurane, and sevoflurane do not require

the addition of preservatives to prevent spontaneous oxidative decomposition.

III. MODE OF ACTION

The primary target sites of general anesthetics are not known. One hypothesis is that the ultimate target sites are ion channels in nerve membranes, influenced by proteins and/or lipids (Franks and Lieb, 1991; Jones, 1990). Changes in conductance through an ionophore may be related to the binding of the anesthetic within the transmembrane of the nerve cell. It is unknown whether gas anesthetics have a direct action on the lipid membrane to disrupt ion flow or whether a second messenger is involved.

Studies of halothane, isoflurane, and enflurane suggest that the major depressant effect involves the enhancement of the inhibitory neurotransmitter gamma aminobutyric acid (GABA) (Moody et al., 1988). GABA effects are believed to be mediated through the release of intracellular calcium. In particular, volatile anesthetics are associated with the ligand-gated ion channel termed GABA_A. When activated this channel causes an increase in the chloride permeability of neurons (Tanelian et al., 1993).

A solution to the mechanisms of general anesthesia has not yet been found that fits the physical, chemical, and physiological factors associated with anesthetics. This is most likely due to the complexity of the neuronal networks involved in general anesthesia. By definition, general anesthesia includes analgesia, loss of muscle function, amnesia, and unconsciousness. Gas anesthetics are capable of producing multiple effects simultaneously. How this is accomplished has yet to be unraveled. A review of the history and current research is covered in other publications (Roy, 2005; Urban, 2002).

TABLE 3-5

ISOFLURANE MINIMUM ALVEOLAR CONCENTRATIONS (MAC) FOR DIFFERENT SPECIES

Species	MAC (ED50) values	Reference
Man	1.28+/-0.04	Stevens et al., 1975
Monkey	1.28+/-0.18	Tinker et al., 1977
Pig	1.75+/-0.1	Tranquilli et al., 1983
Sheep	1.58+/-0.17	Palahniuk et al., 1974
Goat	1.5+/-0.3	Antognini and Eisele, 1993
Dog	1.28+/-0.06	Steffey and Howland, 1977
Cat	1.63+/-0.06	Steffey and Howland, 1977
Rabbit	2.05+/-	Patel and Mutch, 1990
Guinea pig	1.15+/-0.5	Seifen et al., 1989
Rat	1.38+/-0.06	White et al., 1974
Mouse	1.41+/-0.03	Deady et al., 1980
Cockatoo	1.44+/-0.07	Curro et al., 1994
Iguana	3.14+/-0.16	Dohm and Brunson, 1993
(<i>Dipsosaurus dorsalis</i>)		
Dumeril's monitor	1.54+/-0.17	Bertelsen et al., 2005
<i>Iguana iguana</i>	2.0+/-0.6	Mosely et al., 2003

IV. UPTAKE—DISTRIBUTION—ELIMINATION

As previously discussed, alveolar anesthetic concentration is usually a close approximation to brain anesthetic concentrations. The aim during induction and maintenance is to raise the alveolar (brain) anesthetic concentration to the level that causes anesthesia. Three factors determine when alveolar equilibration occurs: ventilation, uptake into the animal, and the inspired anesthetic concentration. [The reader is referred to Eger (1974) and current anesthesia texts for additional discussion.]

If unopposed by uptake, the alveolar concentration would rapidly equal the inspired concentration. Increasing ventilation increases the alveolar anesthetic concentration. Likewise, factors that decrease ventilation slow the equilibration time. Uptake of anesthetic into blood and tissue opposes or limits the rise in alveolar concentration. If more anesthetic is removed into the animal (uptake), the alveolar concentration will be lower

relative to the inspired concentration. Anesthetics with high blood or tissue solubilities (see Section II.E) thus take longer for the alveolar concentration to increase to the level required for anesthesia.

Conditions that increase cardiac output increase the quantity of blood passing through the alveolar membrane per unit time. The higher the cardiac output the larger the quantity of anesthetic removed from the lungs and thus the lower the alveolar concentration. If lower cardiac output results in lower cerebral blood flow and thus slower equilibration of the brain with the arterial anesthetic concentration, faster anesthetic equilibration of the brain is not achieved. However, cerebral blood flow is often preserved even when cardiac output decreases. This potentially can result in rapid, deep anesthesia. If ventilation is held constant, low cardiac output will result in faster increases in alveolar anesthetic concentrations. In patients with low cardiac output and high cerebral blood flow, delivery of high inspired concentrations must be avoided to prevent rapid and potentially excessive anesthetic depression.

The concentration gradient between the alveolus and the blood entering the lungs affects the uptake of the anesthetic: the greater the difference the greater the anesthetic uptake. As equilibration occurs, tissue uptake decreases and the concentration of the anesthetic in the blood returning to the lung is nearly equal to the alveolar concentration. In general, ventilation facilitates whereas tissue uptake and cardiac output oppose equilibration of the alveolar anesthetic concentration with the inspired concentration.

The metabolism of highly soluble inhaled anesthetics may have an effect on anesthetic uptake. The majority of anesthetic metabolism occurs after clinical anesthesia has been discontinued. Anesthetics with high lipid solubilities have the slowest elimination from the lungs and the highest levels of hepatic metabolism. The importance of metabolism is not related to anesthesia recovery but the potential for production of toxic metabolites.

V. INHALED ANESTHETICS

A. Nitrous Oxide

N_2O is included in animal research protocols for the sole reason that it is commonly used in human anesthesia. However, N_2O is a very weak anesthetic for nonprimate species. The principal advantage of N_2O is that it has minimal cardiovascular and respiratory depressive effects. The low blood/gas solubility facilitates rapid equilibration and elimination. The rapid uptake of the high inspired concentration can be used to accelerate the uptake of other inhaled anesthetics (Eger, 1974). This is known as the second gas effect and is most useful during induction of mammalian species that are larger than 2 kg. Animals smaller than 2 kg equilibrate rapidly and hence the second gas effect is of no use. It is important to remember that in order for the

second gas effect to occur, N_2O must be inhaled when the other inhaled anesthetic is already present in the alveoli of the lung.

N_2O is the least potent of the inhaled anesthetics. The human MAC is close to 105% whereas the estimated MAC for dogs is calculated to be $188 \pm 35\%$ (Eger, 1974). The low potency in dogs means that even inspired concentrations of 60–70% will reduce the requirements for other anesthetics by only one-third.

Because of its minimal depressive effects, N_2O is frequently used as an adjunct to other more potent and depressive anesthetics. Care must be taken to ensure that adequate oxygen is delivered to the patient because the low potency requires high delivered N_2O concentrations. The oxygen in N_2O is not available for cellular metabolism. In all cases, a minimum of 20% of the inspired gases must be oxygen (Dorsch and Dorsch, 1998). Oxygen flow rates should be set based on the needs of the animal, with N_2O added to this base flow.

The high flow rates using N_2O result in increased heat loss from the animal. Warm, moist exhaled air is either diluted or washed away from the animal. The high total gas flow also increases the cost associated with anesthesia. Because N_2O and oxygen become carrier gases for the volatile anesthetics, such as isoflurane and sevoflurane, the amount of anesthetic vaporized increases proportionally to the increase in flow. Additional costs of using N_2O include the need for N_2O flow meters and cylinder regulators.

N_2O rapidly diffuses into gas-filled spaces such as intestinal segments or pneumothoraces (Steffey et al., 1979). For this reason, N_2O is not recommended for use in ruminants. Once the use of N_2O is discontinued, oxygen should be administered for approximately 5 minutes to ensure that the animal does not become hypoxic during the rapid exhalation of N_2O .

Human health risks are associated with both the chronic exposure to trace concentrations of N_2O and drug abuse (Dorsch and Dorsch, 1998). Effective scavenging systems must always be used when delivering N_2O . Monitoring of anesthetic use and adequate security should be employed to minimize the inappropriate use of N_2O . N_2O has been associated with atmospheric ozone damage (Schmeltekopf et al., 1975).

In summary, N_2O is a weak anesthetic gas, which should be used only where small reductions in other anesthetics are critical. The use of N_2O in animals does not produce the effects seen in people and should not be included in research protocols for the sole reason of simulating human anesthetic protocols.

B. Ether

Ether was the principal inhaled anesthetic in research prior to the development of nonflammable and more potent gas anesthetics. Ether is not recommended as an anesthetic because it is explosive at concentrations above 1.8% in air and 2.1% in oxygen (Wollman and Smith, 1975). These concentrations are within the range required to produce anesthesia and are frequently present during recovery. Even the bodies of animals that

have been euthanized continue to release ether and have been responsible for explosions when placed in refrigerators prior to disposal. In addition to the hazard of explosion or fire, ether is highly irritating to the respiratory system. Increased production of respiratory secretions and increased bronchoconstriction are common. The use of an anticholinergic, like atropine, was commonly advocated to decrease the signs of respiratory irritation (Wollman and Smith, 1975).

C. Methoxyflurane

The low volatility and high blood solubility of MOF made it safe for use in nonprecision systems. MOF is the most potent of inhaled anesthetics with an ED₅₀ of less than 0.25%. Although the anesthetic equipment for MOF is relatively inexpensive, the cost of the drug has increased due to the lack of its use in human anesthesiology and the limited use in clinical veterinary medicine. Inexperienced researchers with limited anesthesia training preferred MOF because of the perceived safety associated with slow changes in anesthetic depth.

MOF is extensively metabolized and renal toxicity was a significant complication associated with its use in people. Human exposure should be avoided. Metabolites include inorganic fluoride, oxalates, and trifluoroacetic acid, which are nephrotoxic (Brunson et al., 1979). MOF should only be used with a functioning scavenging system or inside a nonrecirculating hood.

MOF is a respiratory depressant. During spontaneous ventilation, animals are hypercarbic. The character of respiration serves as an indicator of anesthetic depth. Apnea will occur at deep anesthetic levels. MOF is nonirritating and does not stimulate tracheobronchial secretions or cause bronchoconstriction (Wollman and Smith, 1975).

The effects of MOF on the circulatory system are characterized by mild-to-moderate hypotension with or without bradycardia. Arterial hypotension is due to reduced myocardial contractility and cardiac output. MOF causes less sensitization of the myocardium to catecholamines than halothane.

In general, MOF is an excellent anesthetic, but is no longer available in North America. Clinical usage has also declined due to the slow onset and recovery and the potential for toxicity due to metabolism. MOF is available from Medical Developments International Limited in Australia.

D. Halothane

Halothane is an inhaled anesthetic which has good potency, low blood/gas solubility, and high volatility. It produces anesthesia rapidly. The high vapor pressure of halothane enables concentrations as high as 33% to be produced, which, combined with rapid equilibration, can lead to lethal levels of anesthesia. Delivery of a controlled anesthetic concentration is necessary for safe anesthesia. Stable anesthetic levels are easily produced within 10 minutes of the start of anesthesia.

Halothane causes respiratory depression which is dose dependent. At deep anesthetic levels, ventilation becomes inadequate. Respiratory depression is not adequate to prevent overdosage and cardiovascular failure.

Halothane causes a direct depression of myocardial muscle and relaxation of vascular smooth muscle. Myocardial contractility, cardiac output, and total peripheral resistance decrease on exposure to halothane. Systemic arterial blood pressure progressively decreases as anesthetic depth deepens. Halothane also sensitizes the myocardium to endogenous or exogenously administered catecholamine.

Halothane increases cerebral blood flow due to direct vasodilatation of vascular smooth muscle. This increased blood flow is not prevented by preanesthetic hyperventilation. Contraindications for halothane include patients with increased intracranial pressure or intracranial hemorrhage.

The availability of alternate gas anesthetics with lower metabolism and thus lower risk of toxicity for both animals and humans minimized the demand for this drug.

E. Isoflurane

Isoflurane maintains cardiovascular functions better than previous generations of gas anesthetics. Like other inhaled anesthetics, isoflurane causes a dose-related depression of systemic arterial blood pressure (Merin, 1993). The decreased blood pressure is due to a combination of myocardial depression and decreased systemic vascular resistance. Isoflurane has less of a depressant effect on myocardial contractility, but causes greater vasodilatory effects when compared to halothane. Isoflurane, like MOF, desflurane, and sevoflurane, does not sensitize the heart to the arrhythmogenic effects of exogenously administered epinephrine (Eger, 1992).

In keeping with the lower myocardial depression and sensitivity to catecholamines, isoflurane has a greater safety margin than halothane in rats. Among avian species, waterfowl are known to have a high incidence of arrhythmias, and the incidence of cardiac arrhythmias has been shown to be lower with isoflurane. The ratio of the concentration to produce cardiovascular collapse with the anesthetic dose (MAC) is called the cardiac anesthetic index. Wolfson et al. (1978) determined that the cardiac anesthetic index for isoflurane and halothane was 5.7 and 3.0, respectively.

Isoflurane has other vasodilatory effects which are important. Isoflurane is frequently used in coronary perfusion studies because it has been shown to be a more potent coronary vasodilator than halothane or enflurane (Merin, 1993). Like other inhalant anesthetics, isoflurane causes an increase in cerebral blood flow. However, unlike halothane, enflurane, or MOF, increases in cerebral blood flow can be prevented if hyperventilation is instituted prior to the administration of isoflurane (Boarini, 1984). For this reason, isoflurane is preferred in situations where cerebral blood flow must not increase.

Isoflurane is a ventilatory depressant. Increasing concentrations produce a progressive decrease in tidal volume and response to rising arterial CO₂ concentrations (Merin, 1993). Respiratory rate may increase as tidal volume decreases. CO₂ or spirometry should be used to determine the adequacy of ventilation during isoflurane anesthesia.

The high molecular stability of isoflurane results in metabolism of less than 0.2% of the inspired dose. This reduces the potential for renal and hepatic injury (Fugita et al., 1991). Human exposure to trace amounts of isoflurane is less hazardous than exposure to MOF, halothane, or sevoflurane (Njoku et al., 1997). Low-flow delivery techniques are recommended to reduce environmental pollution and the associated cost of using isoflurane. Calculated volumes for induction chambers (Section II.B) and precision vaporizers should be used to minimize wastage and increase the control of delivered concentrations.

F. Enflurane

Enflurane, like isoflurane, desflurane, and sevoflurane, is a chemical isomer of MOF. Biotransformation of the delivered dose is between 2 and 10%. Cardiovascular and respiratory characteristics are similar to those of isoflurane. However, unlike other inhalant anesthetics, enflurane was associated with seizure-like muscle contractions at deep surgical anesthetic levels and hyperventilation. Enflurane's effects on the CNS are similar to those of halothane, and include cerebrovascular vasodilation, increased blood flow, and increased intracranial pressure. The availability of isoflurane and sevoflurane resulted in the discontinuation of enflurane in veterinary medicine (Steffey, 2001).

G. Sevoflurane and Desflurane

Sevoflurane and desflurane are two additional potent gas anesthetics that are available for animal anesthesia. Like isoflurane, they are derivatives of MOF and share common attributes with isoflurane; however, sevoflurane and desflurane are pharmacokinetically different from isoflurane, halothane, or MOF, because of their lower solubility in blood (Table 3-1). This results in very rapid equilibration, enabling precise and rapid changes in anesthetic depth (Eger, 1992; Yashuda et al., 1990). The principal advantage of these two new inhalant anesthetics is their rapid induction and recovery. The faster equilibration and elimination is useful in animal research when rapid full recovery from anesthesia is imperative. In comparison to isoflurane, the rapidity of effects will be most noticeable in large-sized animals, such as adult swine, cattle, and horses.

Cardiovascular and respiratory effects are similar to those of isoflurane (Weiskopf et al., 1989). Increasing anesthetic depth causes a progressive reduction in blood pressure and tidal volume (Merin, 1993). Cerebral blood flow can be reduced

if hyperventilation is instituted prior to onset of desflurane delivery (Young, 1992).

Sevoflurane is only metabolized to a small amount, approximately 2%. Degradation in the presence of soda lime and baralyme raised concerns relating to potential toxicity of the metabolites. Two degradation products have been identified as CF₂-C(CF₃)-O-CH₂F (an olefin called compound A) and CH₃-O-CF₂CH(CF₃)-O-CH₂F (compound B). Only compound A is produced in significant quantities. Baralyme, which is composed of more potassium hydroxide than soda lime, produces significantly higher concentrations of compound A (Bito and Ikeda, 1994). The greatest concern is associated with low-flow delivery techniques where an increase in contact time and temperature of the CO₂ absorbent results in greater degradation. Studies have shown that clinically detectable nephrotoxicity or hepatotoxicity does not occur with normal anesthetic delivery (Bito and Ikeda, 1994; Frink et al., 1994). The author recommends flow rates in excess of 20 ml/kg/min when administering sevoflurane.

Unlike desflurane, sevoflurane can be used with conventional methods of vaporization. The mild odor and rapid onset of sevoflurane are associated with less struggling in some animals during mask or chamber inductions. Agent-specific vaporizers must be used to deliver sevoflurane because of its unique vapor pressure.

Desflurane, like isoflurane, has a high molecular stability and low toxicity. The low boiling point of desflurane requires a special heated vaporizer to control delivered concentrations. The high cost of specialized equipment and the limited need for faster anesthetic inductions or recoveries in animal research limit the use of desflurane in both animal clinical and research environments (Jones, 1990). Although desflurane may approach the characteristics of an ideal anesthetic, it still has undesirable cardiovascular side effects. Better anesthetics will undoubtedly be identified when we understand how inhaled anesthetics work at the molecular level. The development of anesthetics without unwanted side effects must await identification of those sites.

VI. MEASUREMENT AND QUALIFICATION OF ANESTHETIC CONCENTRATION FOR RESEARCH

Measurement of the alveolar anesthetic concentration is essential when goals of the research project include evaluation of the effects of inhaled anesthetics or when background levels of anesthesia must be similar in a number of animals. Various methods for measuring anesthetic gas concentrations have been developed and are available for research. Monitors that measure the concentration of gaseous anesthetics are noninvasive and cause minimal interference with research procedures. They are either incorporated into the anesthetic delivery apparatus or

designed to aspirate a gas sample from the apparatus. In order to assess alveolar anesthetic concentrations, the monitor must be placed either on the expiratory side of the anesthetic machine or between the junction of the delivery system and the animal's airway. If the animal is intubated, samples are withdrawn from the endotracheal tube connector.

Estimations of the depth of anesthesia based on either the vaporizer setting or the calculated concentration in an anesthetic chamber will result in wide variability among animals. Monitoring the expired anesthetic concentrations eliminates the problem of estimating the complex dynamic relationship between delivered and alveolar anesthetic concentrations (Morris et al., 1979). Additionally, direct measurement of the anesthetic concentration enables determination of the time point when equilibration of the animal has occurred with the inspired anesthetic concentration. Other procedures used to ensure a stable anesthetic plane, such as initially using high anesthetic concentrations and flow rates, are simplified by actually measuring the anesthetic concentration (Morris et al., 1979).

A. Nonspecific Methods of Measurement

Anesthetic gas concentrations have been measured with a variety of techniques that are based on some physical property of the gas whereby the components can be identified and the quantity of each determined. Numerous nonspecific techniques have been used including molecular density, thermal conductivity, refractive index, and alterations in the transmission of sound. These techniques require rigid control of the composition of the analyzed gases where only two gases can be present. Additionally nonspecific methods often require larger sample sizes and have a longer response time than other methods (Payne, 1971).

The concentration of volatile anesthetic agents can be monitored by a piezoelectric crystal technique. The natural resonance frequency of a lipophilic-coated piezoelectric quartz crystal changes proportionally with the anesthetic concentration (Humphrey et al., 1991; Westenskow and Silva, 1991). Early piezoelectric analyzers had a relatively slow response times and were sensitive to water vapor. Improvements in design have resulted in a piezoelectric analyzer which compares favorably with other techniques (Westenskow and Silva, 1991). The piezoelectric crystal has a short 2-minute warm-up time and a rapid response time of less than 0.05 seconds. Interferences by other lipophilic gases, water vapor, and N_2O must be considered when using this technique. (Parbrook et al., 1990; Westenskow and Silva, 1991).

B. Specific Methods of Measurement

Methods that specifically identify anesthetics are used when gas mixtures have varying composition and contain more

than two gases. Examples of these methods include infrared spectroscopy, mass spectrometry, and gas chromatography.

Infrared spectroscopy is probably the most widely used technique for measuring volatile anesthetics (Nielsen et al., 1993). All gases either absorb or emit electromagnetic radiation in the infrared visible or ultraviolet light ranges (Payne, 1971). Since all polyatomic gases are excited by specific infrared wavelengths, they have characteristic absorption patterns in the range of 1–15 μm . (Payne, 1971). The accuracy of infrared analyzers is affected by the presence of water vapor, presence of other gases with absorption spectra which overlap the anesthetic of interest, and the size of the sample. Interference of exhaled methane by animals has been shown to affect halothane measurements by infrared analyzers (Jantzen, 1990). Ethyl alcohol in expired air caused an infrared anesthetic analyzer to register a vapor concentration as though it were measuring halothane (Foley et al., 1990). Guyton and Gravenstein (1990) evaluated the Datex Capnomac PB254^B infrared analyzer. Alcohol had a slight but clinically insignificant effect on isoflurane and enflurane, but the effect was greater with halothane. Mixtures of volatile anesthetics resulted in measurements that were additive (Guyton and Gravenstein, 1990).

The peak absorptions of infrared for halothane and methane are similar and often interfere with each other. Erroneous measurements were common when attempting to measure halothane expired concentrations from large herbivores such as horses, cattle, sheep, and goats. The influence of methane is about seven times less when measuring isoflurane compared to halothane. Absorption characteristics of anesthetics and the amplification characteristics of the analyzer are the factors determining interference of methane with gas anesthetics (Mortier et al., 1998). Effective water traps are essential when working with large animals, as the accumulation of water in the analyzer will also interfere with accurate readings of the anesthetic vapors. Methane interference with isoflurane measurement at short wavelength is significant at low flow rates but independent of the isoflurane concentration (Dujardin et al., 2005).

Gas sample lines for infrared analyzers come in a variety of lengths. Calibration of the analyzer should be done with the sample line used for the study. Additionally, agent monitors designed for clinical use may have an accuracy of $\pm 10\%$, which must be considered for evaluation of study results.

Mass spectrometry separates and distributes the actual components of a mixture (Gillbe et al., 1981). The components and their quantities can then be calculated based on their mass/charge ratio and the proportions of molecular weight (Jantzen, 1990). The rapid response time (<0.05 seconds) enables the mass spectrometer to follow changes within the respiratory cycle. Additionally mass spectrometry can analyze very small samples (Larach et al., 1988). Larach et al. (1988) measured simultaneously CO_2 , halothane, and other respiratory gases in rats that were as small as 250 g. Continuous sampling does not distort end tidal CO_2 or arterial oxygen measurements.

These advantages are generally outweighed by the mass spectrometers large size, complexity, and high cost (Parbrook et al., 1990; Payne, 1971).

Gas chromatography is a technique that can be used to measure volatile anesthetics in liquids or gases; it allows identification and measurement of very low concentrations of gas mixtures. Response time is dependent on the passage of the sample through a silica gel column and only provides serial measurements rather than continuous measurements (Parbrook et al., 1990; Payne, 1971). An additional disadvantage is that measurements of volatile anesthetics in tissue or fluid require extraction by organic solvents, which is time-consuming and costly. Janicki et al. (1990) describe an alternate method for analyzing fluid samples by using a high-performance liquid chromatographic (HPLC) method.

VII. SUMMARY

In summary, each inhalant anesthetic discussed in this chapter has been used successfully for animal anesthesia. The determining factors for selection of an appropriate gas anesthetic for laboratory animals must include the primary reason for anesthesia, the physiological effects under study, and the availability of the gas anesthetic. The low solubility and high potency of isoflurane, sevoflurane, and desflurane can result in rapid deep anesthesia. In the research environment, isoflurane and sevoflurane are excellent anesthetics. Safety is directly associated with adequate training of individuals delivering the anesthetic drugs and appropriate monitoring of animals. The rapidity of changes in anesthetic depth requires a high level of knowledge and training in monitoring anesthetized animals. Researchers must be vigilant while adjusting the delivery of isoflurane and sevoflurane in order to avoid accidental overdose.

REFERENCES

- Antognini, J.F., and Eisele, P. (1993). Anesthetic potency and cardiopulmonary effects of enflurane, halothane, and isoflurane in goats. *Lab. Anim. Sci.* **13**, 607–610.
- Bertelsen, M.F., Mosley, C.A.E., et al. (2005). Minimum alveolar concentration of isoflurane in mechanically ventilated Dumeril monitors. *J. Am. Vet. Med. Assoc.* **226**, 1098–1101.
- Bito, H., and Ikeda, K. (1994). Long-duration, low-flow sevoflurane anesthesia using two carbon dioxide absorbents. Quantification of degradation products in the circuit. *Anesthesiology* **81**, 340–345.
- Boarini, D.J. (1984). Comparison of systemic and cerebrovascular effects of isoflurane and halothane. *Neurosurgery* **15**, 400–409.
- Brunson, D.B. (1990). "A Compendium on Aerrane for Canine and Equine Anesthesia." Anaquest, Inc., Madison, WI.
- Brunson, D.B., Stowe, C.M., and McGrath, C.J. (1979). Serum and urine inorganic fluoride concentrations following methoxyflurane anesthesia in the dog. *Am. J. Vet. Res.* **40**, 197–203.
- Carpenter, R.L., Eger, E.I., Johnson, B.H., Unadkat, J.D., and Sheiner L.B. (1986). The extent of metabolism of inhaled anesthetics in humans. *Anesthesiology* **65**, 201–205.
- Curro, T.G., Brunson, D.B., and Paul-Murphy, J. (1994). Determination of the ED50 of isoflurane and evaluation of the isoflurane sparing effect of butorphanol in cockatoos, *Cacatua* spp. *Vet. Surg.* **23**, 429–433.
- Deady, J.E., Koblin, D.D., and Eger, E.I. (1980). Anesthetic potencies and the theories of narcosis. *Anesth. Analg.* **59**, 535.
- Dohm, L., and Brunson, D.B. (1993). Effective dose of isoflurane for the desert iguana *Dipsosaurus dorsalis* and the effect of hypothermia on effective dose. *Vet. Surg.* **22**, 547.
- Dorsch, J.A., and Dorsch, S.E. (1998). "Understanding Anesthesia Equipment," 4th ed., pp 121–182. Williams and Wilkins, Baltimore, MD.
- Dujardin, C.L.L., Gootjes, P., and Moens, Y. (2005). Isoflurane measurement error using short wavelength infrared techniques in horses: Influence of fresh gas flow and pre-anesthetic food deprivation. *Vet. Anesth. Analg.* **32**, 101–106.
- Eger, E.I. (1964). Respiratory and circulatory factors in uptake and distribution of volatile anaesthetic agents. *Br. J. Anaesth.* **36**, 155–171.
- Eger, E.I. (1974). MAC. U. "Anesthetic Uptake and Action" (E.I. Eger, ed.), pp 1–25, Williams and Wilkins, Baltimore, MD.
- Eger, E.I. (1985). "Isoflurane (Forane), A Compendium and Reference," pp 1–160. Anaquest, Inc., Madison, WI.
- Eger, E.I. (1992). Desflurane animal and human pharmacology: aspects of kinetics, safety, and MAC. *Anesth. Analg.* **75**, 53–59.
- Foley, M.A., Wood, P.R., Peel, G.M., and Lawler, P.G. (1990). The effect of exhaled alcohol on the performance of the datex capnomac. *Anaesthesia* **45**, 232–234.
- Franks, N.P., and Lieb, W.R. (1991). Stereospecific effects of inhalational general anesthetic optical isomers on nerve ion channels. *Science* **254**, 427–430.
- Frink, E.J., Isner, R.J., Malan, T.P., Morgan, S.E., Jr., Brown, E.A., and Brown, B.R., Jr. (1994). Sevoflurane degradation product concentrations with soda lime during prolonged anesthesia. *J. Clin. Anesth.* **6**, 239–242.
- Fugita, Y., Kimura, K., Hamada, H., and Takaori, M. (1991). Comparative effects of halothane, isoflurane, and sevoflurane in the liver with hepatic artery ligation in the beagle. *Anesthesiology* **75**, 313–318.
- Gillbe, C.E., Heneghan, C.P.H., and Branthwaite, M.A. (1981). Respiratory mass spectrometry during general anaesthesia. *Br. J. Anaesth.* **53**, 103–109.
- Guyton, D.C., and Gravenstein, N. (1990). Infra-red analysis of volatile anesthetics: impact of monitor agent setting, volatile mixtures, and alcohol. *J. Clin. Monit.* **6**, 203–206.
- Holiday, D.A., and Smith, F.R. (1981). Clinical characteristics and biotransformation of sevoflurane in healthy human volunteers. *Anesthesiology* **54**, 100–106.
- Humphrey, S.J.E., Luff, N.P., and White, D.C. (1991). Evaluation of the lamtec anaesthetic agent monitor. *Anaesthesia* **46**, 478–481.
- Janicki, P.K., Erskine, W.A.R., and James, M.P.M. (1990). High performance liquid chromatographic method for the direct determination of the volatile anaesthetics halothane, isoflurane, and enflurane in water and in physiological buffer solutions. *J. Chromatogr.* **518**, 250–253.
- Jantzen, J.P.A.H. (1990). Does fresh gas flow tare affect monitoring requirements? *Acta Anaesthesiol. Belg.* **41**, 211–224.
- Jones, R.M. (1990). Desflurane and sevoflurane: inhalation anaesthetics for this decade? *Br. J. Anaesth.* **65**, 527–536.
- Kaufman, R.D. (1977). Biophysical mechanisms of anesthetic action: historical perspective and review of current concepts. *Anesthesiology* **46**, 49–62.
- Kazama, T., and Ikeka, K. (1988). Comparison of MAC and the rate of rise of alveolar concentration of sevoflurane with halothane and isoflurane in the dog. *Anesthesiology* **68**, 435–437.
- Koblin, D.D. (1992). Characteristics and implications of desflurane metabolism and toxicity. *Anesth. Analg.* **75**, S10–S16.
- Larach, D.R., Shuler, H.G., Skeehan, T.M., and Deer, J.A. (1988). Mass spectrometry for monitoring respiratory and anesthetic gas waveforms in rats. *J. Appl. Physiol.* **65**, 955–963.

- Linde, H.W. (1971). The physics and chemistry of general anesthetics. In "Textbook of Veterinary Anesthesia." (L.R. Soma, ed.), pp 30–49, Williams and Wilkins Co., Baltimore, MD.
- Lowe, H.J., and Hagler, K. (1971). Clinical and laboratory evaluation of an expired anesthetic gas monitor (Narko-test). *Anesthesiology* **34**, 378.
- Mathews, N.S., Dollar, N.S., and Shawley, R.V. (1990). Halothane sparing effect of benzodiazepines in ponies. *Cornell Vet.* **80**, 259–265.
- Merin, R.G. (1993). Are differences in cardiopulmonary effects among the inhalation agents clinically important? *Proc. ASA Refresher Course Lectures, Washington D.C.*, Lecture 226, pp 1–6.
- Moody, E.J., Suzdak, P.D., Paul, S.M., and Skolnick, P. (1988). Modulation of the benzodiazepine/gamma-aminobutyric acid receptor chloride channel complex by inhalation anesthetics. *J. Neurochem.* **51**, 1386–1393.
- Morris, P., Tatnall, M.L., and West, P.G. (1979). Breath-by-breath halothane monitoring during anaesthesia: a study in children. *Br. J. Anaesth.* **51**, 979–982.
- Mortier, E., Rolly, G., and Versichelen, L. (1998). Methane influences infrared technique anesthetic agent monitors. *J. Clin. Monit.* **12**, 85–88.
- Mosley, C.A.E., Dyson, D., and Smith, D.A. (2003). Minimum alveolar concentration of isoflurane in green iguanas and the effect of butorphanol on minimum alveolar concentration. *J. Am. Vet. Med. Assoc.* **222**, 1559–1564.
- Nielsen, J., Kann, T., and Moller, J.T. (1993). Evaluation of three transportable multigas anesthetic monitors: the Bruel & Kjaer anesthetic gas monitor 1304, the datex capnomac ultima, and the Nellcor N-2500. *J. Clin. Monit.* **9**, 91–98.
- Njoku, D., Lester, M.J., Gong, D.H., et al. (1997). Biotransformation of halothane, enflurane, isoflurane, and desflurane to trifluoroacetylated liver proteins: association between protein acylation and hepatic injury. *Anesth. Analg.* **84**, 173–174.
- Palahniuk, R.J., Shnider, S.M., and Eger, E.I. (1974). Pregnancy decreases the requirements for inhaled anesthetic agents. *Anesthesiology* **41**, 82–83.
- Parbrook, G.D., Davis, P.D., and Parbrook, E.O. (1990). Gas chromatography and mass spectrometry. In "Basic Physics and Measurement in Anaesthesia." pp 257–264. Butterworth-Heinemann, Boston, MA.
- Patel, P.M., and Mutch, W.A. (1990). The cerebral pressure-flow relationship during 1.0 MAC isoflurane anesthesia in the rabbit: the effects of different vasopressors. *Anesthesiology* **72**, 118–124.
- Payne, J.P. (1971). Measurement of concentration of inhalation agents and respiratory gases in gas and blood. In "General Anaesthesia." (Gray and Nunn, eds.), pp 677–689, Butterworth & Co., London.
- Price, H.L. (1975). General Anesthetics (continued). In "Pharmacological Basis of Therapeutics." (Goodman and Gillman, eds.), pp 89–96, MacMillan Pub. Co. Inc., New York.
- Quasha, A.L., Eger, E.I., and Tinker, J.H. (1980). Determination and application of MAC. *Anesthesiology* **53**, 315–334.
- Schmeltekopf, A.L., Goldan, P.D., Henderson, W.R., Harrop, W.J., Thompson, T.L., Fehenfeld, F.C., Schiff, H.I., Crutzen, P.J., Isaksen, I.S.A., and Ferguson, E.E. (1975). Measurement of stratospheric CFCl₃, SF₂, Cl₂, and N₂O. *Geophys. Res. Lett.* **2**, 393–396.
- Seifen, A.B., Kennedy, R.H., Bray, J.P., and Seifen, E. (1989). Estimation of minimum alveolar concentration (MAC) for halothane, enflurane and isoflurane in spontaneously breathing guinea pigs. *Lab. Anim. Sci.* **39**, 579–581.
- Steffey, E.P. (1978). Enflurane and isoflurane anesthesia: A summary of laboratory and clinical investigations in horses. *J. Am. Vet. Med. Assoc.* **172**, 367–373.
- Steffey, E.P., and Howland, D.D. (1977). Isoflurane potency in the dog and cat. *Am. J. Vet. Res.* **38**, 1833–1836.
- Steffey, E.P., Johnson, B.J., Eger, E.I., and Howland, D. (1979). Nitrous oxide: Effects on accumulation rate and uptake of bowel gases. *Anesth. Analg.* **58**, 405–408.
- Steffey, E.P., Woliner, M.L., and Howland, D. (1983). Accuracy of isoflurane delivery by halothane specific vaporizers. *Am. J. Vet. Res.* **44**, 1072–1078.
- Stevens, W.C., Dolan, W.M., and Gibbons, R.T. (1975). Minimum alveolar concentrations (MAC) of isoflurane with and without nitrous oxide in patients of various ages. *Anesthesiology* **42**, 197–200.
- Tanelian, D.L., Kosek, P., Mody, I., and MacIver, M.B. (1993). The role of the GABA_A receptor/chloride channel complex in anesthesia. *Anesthesiology* **78**, 757–776.
- Tinker, J.K., Sharbrough, F.W., and Michenfelder, J.D. (1977). Anterior shift of the dominant EEG rhythm during anesthesia in the Java monkey: Correlation with anesthetic potency. *Anesthesiology* **46**, 242–259.
- Tranquilli, W.J., Thurmon, J.C., Benson, G.J., and Steffey, E.P. (1983). Halothane potency in pigs (*Sus scrofa*). *Am. J. Vet. Res.* **44**, 1106–1107.
- Weiskopf, R.B., Holmes, M.A., Rampil, I.J., Johnson, B.H., Yasuda, N., Targ, A.G., and Eger, E.I. (1989). Cardiovascular safety and actions of high concentrations of I-653 and isoflurane in swine. *Anesthesiology* **70**, 793–798.
- Westenskow, D.R., and Silva, F.H. (1991). Laboratory evaluation of the vital signs (ICOR) piezoelectric anesthetic agent analyzer. *J. Clin. Monit.* **7**, 189–194.
- White, P.F., Johnston, R.R., and Eger, E.I. (1974). Determination of anesthetic requirements in rats. *Anesthesiology* **40**, 52–57.
- Wolfson, B., Hetrick, W.D., Lake, C.L., and Siker, E.S. (1978). Anesthetic indices: Further data. *Anesthesiology* **48**, 187–190.
- Wollman, H., and Smith, T.C. (1975). Uptake, distribution, elimination, and administration of inhalational anesthetics. In "Pharmacological Basis of Therapeutics." (Goodman and Gillman, eds.), pp 71–83. MacMillan Pub. Co. Inc., New York.
- Yashuda, N., Targ, A.G., Eger, E.I., Johnson, B.H., and Weiskopf, R.B. (1990). Pharmacokinetics of desflurane, sevoflurane, isoflurane and halothane in pigs. *Anesth. Analg.* **71**, 340–348.
- Young, W.L. (1992). Effects of desflurane on the central nervous system. *Anesth. Analg.* **75**, S32–S37.

This page intentionally left blank

Pharmacology of Analgesics

James E. Heavner and Dale M. Cooper

I. Introduction	98
II. Analgesic-Antipyretic and Anti-Inflammatory Drugs	99
A. Overview	99
B. Salicylates	103
C. Pycazolone Derivatives	104
D. <i>p</i> -Aminophenol Derivatives	105
E. Acetic Acid Derivatives	105
F. Fenamates	106
G. Propionic Acid Derivatives	106
H. Oxicams	107
I. Nicotinic Acid Derivatives	107
J. Alkanones	108
K. Selective COX-2 Inhibitors	109
L. Dual Inhibitors of COX and LOX	109
III. Opioids	109
A. Overview	109
B. Morphine and Related Opioids	110
C. Meperidine and Congeners	113
D. Methadone and Congeners	114
E. Synthetic Opioid Agonists	114
F. Opioids with Mixed Actions: Agonist–Antagonists and Partial Agonists	114
G. Opioid Antagonists	115
IV. α_2 -Adrenergic Agonists	115
A. Overview	115
B. α_2 -Adrenergic Antagonists	117
V. NMDA-Receptor Antagonists	117
A. History	118
B. Mechanism of Action	118
C. Preparation and Routes of Administration	118
VI. Analgesic Adjuvants	118
VII. Future Prospects	118
Acknowledgment	118
References	118

I. INTRODUCTION

Pain has been defined by the International Association for the Study of Pain as “an unpleasant sensory and emotional experience associated with actual or potential tissue damage or described in terms of such damage. It is always subjective” (Merskey and Bogduk, 1994).

A variety of terms are used to describe certain characteristics of pain, e.g., acute pain, persistent pain, chronic pain, neuropathic pain, nociceptive pain, inflammatory pain, visceral pain, and somatic pain. These groupings support the concept that different anatomical and neurobiological substrates for pain exist. The concept provides a foundation for targeted pain therapy (Woolf et al., 1998) and explains why the effectiveness of analgesics varies depending upon the characteristics of pain. For example, analgesic drugs effective against nociceptive pain may have limited effectiveness against neuropathic pain.

Pain is a well-recognized stressor in animals. Maladaptive behavior is one sign of distress and, sometimes, the only one (Quimby, 1991). As shown in Figure 4-1, a relationship exists among pain, fear, anxiety, and sleep, the awareness for which is important to the understanding of why some approaches to pain treatment are used. Pharmacological approaches to managing pain (preventing or stopping) may include the administration of analgesics and drugs to treat the consequences of pain (e.g., anxiolytics). This chapter deals with five groups of drugs used in pain management: (1) analgesic–antipyretic and anti-inflammatory drugs, (2) opioids, (3) α_2 -adrenergic agonists, (4) NMDA-receptor antagonists, and (5) analgesic adjuvants. General and local anesthetics will not be discussed here, but

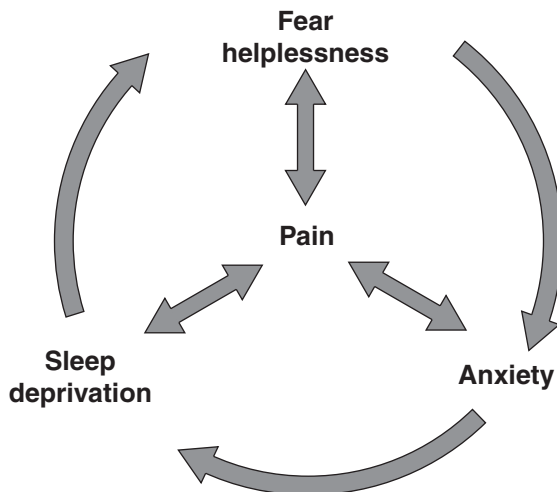

Fig. 4-1 The pain cycle. In humans, a sense of helplessness and fear add to the total suffering of the patient and exacerbate the pain, as does anxiety and sleep loss. It is reasonable to assume that the same thing happens in animals. Therefore, drugs that aid sleep, reduce anxiety, and produce a sense of well-being play a role in pain management.

they obviously are used in pain management, especially in the perioperative period. Nor will the use of corticosteroids be discussed, but it is acknowledged that epidural steroid injection in humans to treat low back pain, with or without radiculopathy, is a common practice. Analgesic adjuvants will be mentioned here, though briefly.

The chapter cites a significant amount of data regarding the pharmacology of analgesics in humans because this information is well documented and readily available. Likewise, it emphasizes data from well-studied drugs that represent particular pharmacologically distinct drug classes. The data provide a solid base for illustrating important pharmacological properties that must be considered when selecting and using analgesics in laboratory animals. The amount of scientifically valid data regarding the use of analgesics in laboratory animals is increasing, which has facilitated the presentation of similarities or differences with the class-representative drugs. The pharmacodynamic effects of analgesics vary between animals and humans, and among animal species and even strains, but the greatest differences are in pharmacokinetic factors. The processes of absorption, biotransformation, and elimination vary remarkably. Detailed information about species-specific features of analgesics is discussed elsewhere in this volume in chapters describing the clinical use of analgesics in different species.

The term “potency” is used to compare analgesics in this chapter and throughout the literature to convey two different meanings. One is the relative doses of analgesics required to achieve a pain reduction goal (e.g., to achieve equal analgesia with meperidine and morphine, a meperidine dose 10 times the morphine dose may be required). The other meaning implies a “ceiling” effect; i.e., no matter how large the dose of buprenorphine, analgesia cannot be achieved equal to the analgesia achieved with morphine, or that less potent analgesics are effective only against mild-to-moderate pain. Obviously, knowing that 10 times as much of one drug is required to reach the same analgesic endpoint achieved with another is important when determining the doses to be given. On the other hand, information about the ceiling effect is important when considering which analgesic to use for a specific analgesic endpoint.

An important factor to consider when evaluating efficacy is the analgesiometric method used. Analgesiometric assays involve applying a putatively painful stimulus (e.g., heat, cold, pressure, irritating chemical, incision, and organ distension), inflammation, or nerve damage and measuring a response (e.g., escape behavior, neurochemical response). A variation on classic analgesiometry is to perform a potentially painful procedure on an animal and measure behavioral or physiological changes, such as motor activity, food and water consumption, licking, rearing, change in body weight, heart rate, or blood pressure. In order to attribute these changes to pain, it is necessary to use appropriate positive and negative controls, as anesthesia and certain analgesics in the absence of a painful stimulus can also

cause some of these changes (Cooper et al., 2005; Liles and Flecknell, 1992). Depending on the stimulus that is applied and the response being measured, the same drug at the same dose can provide different potency results. For example, opioid agonists tend to demonstrate higher potency than do nonsteroidal anti-inflammatory drugs (NSAIDs) in assays that measure acute, deep, or visceral pain (e.g., heat stimulus and tail or foot withdrawal). However, in an assay that creates inflammation (e.g., carageenan injection into a footpad prior to application of heat), because of their mechanism of action, NSAID potency is substantially improved. When evaluating the behavioral changes following a surgery, opioids may have effects on activity, reactivity, and feeding behavior that complicate the interpretation of the data.

One concern with administering analgesics to laboratory animals is what influence an analgesic will have on experimental outcomes. On the one hand, responses may be influenced by the intended pharmacological action (analgesia) of the drug. On the other hand, responses may be modified because of side effects, e.g., reduced renal blood flow caused by analgesic-antipyretic and anti-inflammatory drugs. Predominant side effects of analgesics will be mentioned, but a comprehensive discussion of these effects is beyond the scope of this chapter.

Much of the information presented in the chapter on analgesics in the first edition of this book appears in this chapter, although significant new information has been added. Undoubtedly, the biggest advance has been in the understanding of the effects of analgesic-antipyretic and anti-inflammatory drugs on the enzyme cyclooxygenase (COX) and the biological consequences, and the appearance of COX-2-selective drugs on the market.

II. ANALGESIC–ANTIPYRETIC AND ANTI-INFLAMMATORY DRUGS

A. Overview

Drugs in this group are the most commonly used analgesics in humans; their advantages include high oral bioavailability, long duration of effect, lack of sedation, and minimal potential for abuse and development of tolerance.

These drugs are generally grouped according to their chemical structures, e.g., *p*-aminophenol derivatives, oxicam, salicylates, fenamates, propionic acids, pycazolone, acetic acids, and nicotinic acid derivatives. More recently, another grouping or subgrouping of these drugs is based on COX enzyme inhibitory activity. They share the ability to inhibit the COX enzyme. Various forms of the COX enzymes exist (e.g., COX-1 and COX-2), and NSAIDs of clinical interest are classified as nonselective inhibitors of COX-1 and COX-2 or selective inhibitors of COX-2 (Table 4-1). One example of a dual COX and lipoxygenase (LOX) inhibitor is also discussed. Analgesic-antipyretic and anti-inflammatory drugs are, for the most part, human drugs, but have become increasingly important in the clinical practice of laboratory animal medicine.

The details regarding the safety and efficacy of analgesic-antipyretic and anti-inflammatory drugs in laboratory animals, from a clinical perspective, are becoming increasingly available. The drugs must certainly have been investigated in animals as part of the process to obtain approval to market them for human use, but the conditions of these studies are different from those encountered in the clinical practice of laboratory animal medicine. In addition, this information

TABLE 4-1

CLASSES OF ANALGESIC–ANTIPYRETIC AND ANTI-INFLAMMATORY DRUGS

Class	Generic names
Non-selective COX inhibitors	
Salicylic acid derivatives	Aspirin, diflunisal, choline magnesium, trisalicylate, sodium salicylate, salsalate, sulfasalazine, olsalazine
Pycazolone	Phenylbutazone
<i>p</i> -Aminophenol derivatives	Acetaminophen
Acetic acids	Indomethacin, tolmetin, sulindac, suprofen, diclofenac, ketorolac
Fenamates	Mefenamic acid, meclofenamic acid
Aryl propionic acids	Ibuprofen, naproxen, naproxen sodium, fenoprofen, ketoprofen, flurbiprofen, carprofen
Enolic acids	Oxicam, piroxicam, meloxicam
Nicotinic acid derivatives	Flunixin
Alkanones	Nabumetone
Selective COX-2 inhibitors	
<i>Diaryl-substituted furanones</i>	Rofecoxib Deracoxib Firocoxib
<i>Diaryl-substituted pyrazoles</i>	Celecoxib
<i>Indole acetic acids</i>	Etodolac
<i>Sulfonanilides</i>	Nimesulide

is not readily available in texts or the peer-reviewed literature. Some analgesic-antipyretic and anti-inflammatory drugs have been used in veterinary medicine for many years (e.g., phenylbutazone, flunixin, aspirin).

1. History

Recognition of the antipyretic effects of willow bark led to the search for the active component. Leroux isolated salicin, which was found to be antipyretic, from willow bark in 1829. Hydrolysis of salicin yields glucose and salic alcohol. The latter can be converted to salic acid. In 1875, sodium salicylate was first used for the treatment of rheumatic fever and as an antipyretic. Acetylsalicylic acid was synthesized by Hoffman and introduced into medicine in 1899 under the name aspirin, after the demonstration of its anti-inflammatory effects.

The development of newer aspirin-type drugs began nearly 60 years later and included drugs such as phenylbutazone, indomethacin, ibuprofen, tolectin, naproxen, fenoprofen, and sulindac.

2. Mechanism of Action

Aspirin is the prototype drug for this group. It has analgesic, antipyretic, and anti-inflammatory activities. The precise mechanism of action of drugs in this class is unknown, but inhibition of the COX enzyme is thought to be important for the intended pharmacologic effect.

In 1971, Vane and associates and Smith and Willis demonstrated (Insel, 1990) that low concentrations of aspirin and indomethacin inhibit the enzymatic production of prostaglandins (PG). PG are among a number of chemicals that are released following tissue damage, and affect nociceptors. PG increase the sensitivity of nociceptors to other chemicals, and mechanical or thermal stimuli.

Inhibition of the conversion of arachidonic acid to the unstable endoperoxide intermediate, prostaglandin G (PGG₂), a reaction that is catalyzed by COX, is thought to be the primary mechanism of action of analgesic-antipyretic and anti-inflammatory drugs. Two forms of COX, i.e., COX-1 and COX-2, catalyze the transformation of arachidonic acid to PGG₂. Arachidonic acid is liberated from membrane-bound phospholipids, usually by the action of phospholipase enzymes (Warner and Mitchell, 2004). Both COX-1 and COX-2 form PGG₂ via identical enzymatic processes. PGG₂ is converted to prostaglandin H₂ (PGH₂), which can be biotransformed by different enzymatic pathways to a range of products with potential biological effects (Fig. 4-2). Some of the products participate in the inflammatory process [e.g., prostaglandin E₂ (PGE₂)] and others participate in physiological processes such as the maintenance of the integrity of the gastrointestinal (GI) mucosa. COX-1 generally resides in tissues (constitutive), whereas COX-2 production is induced by stimuli (inducible) that initiate the inflammatory response. However, both COX-1

and COX-2 are constitutively expressed in some tissues, e.g., dorsal root ganglion, spinal dorsal and ventral gray matter. Products of COX-1 regulate rapid physiological responses such as vascular hemostasis, gastric function, platelet activity, and renal function (Power, 2005). In general, the analgesic action of analgesic-antipyretic and anti-inflammatory drugs is due to COX-2 inhibition, and the side effects are due to COX-1 inhibition. This prompted the search for COX-2-selective drugs. A slightly larger active site in the COX-2 enzyme than in the COX-1 enzyme allows the development of COX-2-selective drugs that fit into the larger site (Power, 2005). The relative selectivity of drugs as inhibitors of COX-1 and COX-2 ranges from predominately selective for COX-1 (ketorolac) to purely selective for COX-2 (lumiracoxib) (Warner and Mitchell, 2004; Fig. 4-3). The relative roles of COX-1 and COX-2 are still debatable and not completely understood. Some researchers feel that the effects of COX-1 on analgesia are as important as those of COX-2, and selective COX-2 inhibitors can cause some side effects similar to those of COX-1 inhibitors (Clark, 2006; Shannon, 2007). There is also variability in the relative degree of COX selectivity among species, which may be due to the differences in methodology used to measure COX selectivity (Streppa et al., 2002).

COX-3 has been described, but its importance and status relative to COX-1 and COX-2 are yet to be determined. COX-3 was first identified in canine cortical tissue as a splice variant of COX-1, which was selectively inhibited by acetaminophen, phenacetin, antipyrine, and dipyron (Chandrasekharan et al., 2002). It has also been identified in the brain of patients suffering from Alzheimers disease, as well as in mice and rats (Ayoub et al., 2004; Cui et al., 2004; Snipes et al., 2005). However, its role in clinical mediation of pain and fever is debated based on dissimilarities in gene homology with COX-1 and COX-2 enzymes, low expression level, and kinetic data (Kis et al., 2005).

PGE₂, a product of COX-2 enzymatic action, plays a role in the perception of pain in the periphery and within the central nervous system (CNS) (Fig. 4-4). Thus, the effectiveness of analgesic-antipyretic and anti-inflammatory drugs in acute pain conditions may be explained by their effects either at central sites or at peripheral sites (Warner and Mitchell, 2004). It is now understood that analgesic-antipyretic and anti-inflammatory drug effects such as analgesia and fluid retention are largely explained by the inhibition of both constitutively expressed and inducible COX-2, while the role of COX-1 on these still remains debatable (Clark, 2006; Shannon, 2007).

Rofecoxib and celecoxib were the first two COX-2-selective drugs developed and marketed specifically for this action. Rofecoxib has been removed from the market because of unwanted cardiovascular side effects. Drugs already available that exhibit some COX-2 selectivity include etodolac, meloxicam, carprofen, and nimesulide. Other COX-2-selective inhibitors available or under development include valdecoxib, etoricoxib, lumiracoxib, deracoxib, and firocoxib. Noteworthy is that, as

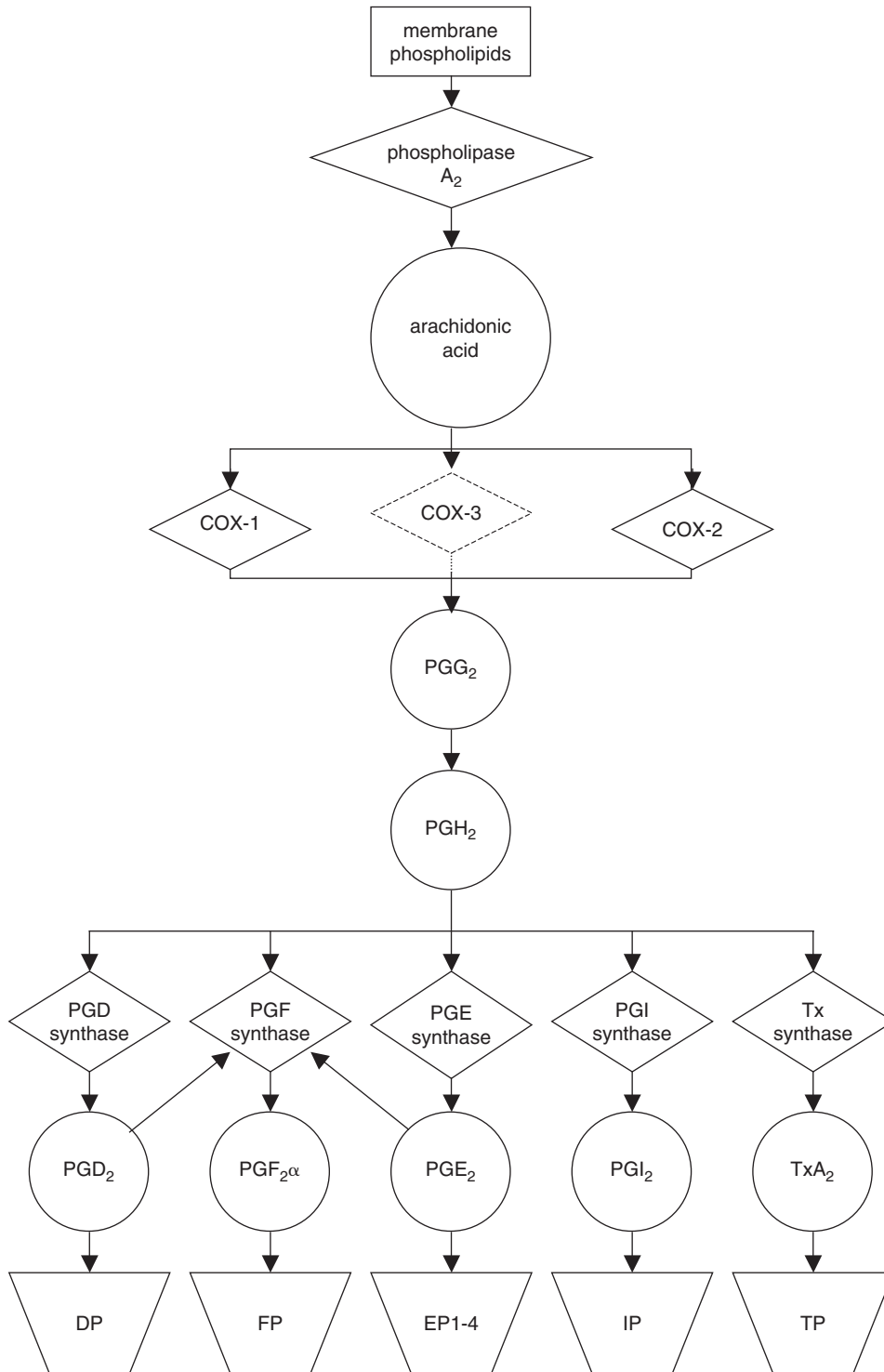

Fig. 4-2 Schematic pathway of prostanoid formation and actions. [From Warner and Mitchell (2004 Fig. 1, p. 791).]

with nonselective COX inhibitors, there are a number of chemically different structural classes of COX-2-selective inhibitors (Table 4-1).

Some agents are competitive inhibitors of COX, whereas others permanently modify the enzyme. Aspirin, e.g., irreversibly

acetylates a serine residue at or near the active site of COX (Roth and Siok, 1978). The effect of aspirin on platelet function lasts throughout the lifetime of platelets (8–11 days).

Some analgesic–antipyretic and anti-inflammatory drugs also reversibly regulate neutrophil phagocytosis and secretion of

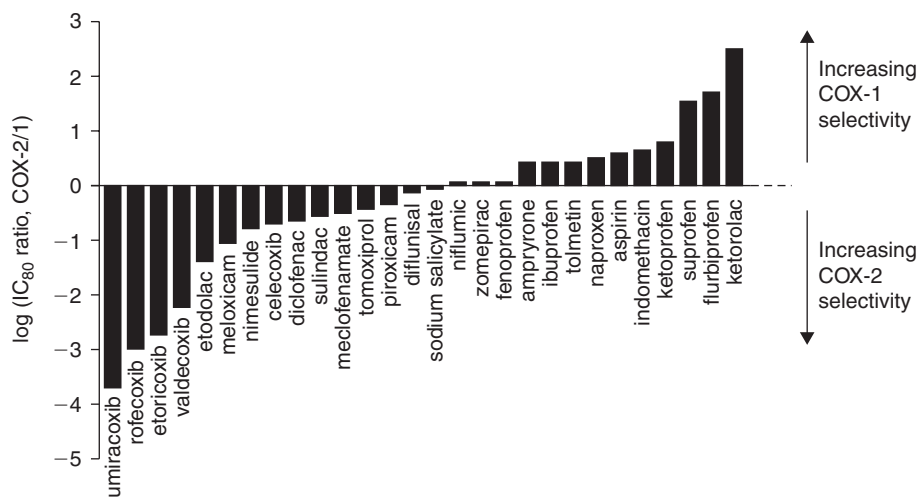

Fig. 4-3 Relative selectivity of agents as inhibitors of human COX-1 and COX-2 displayed as the ratio of IC₈₀ concentrations. Inhibitor curves for compounds against COX-1 and COX-2 were constructed in a human-modified whole blood assay and used to calculate IC₈₀ concentration. The IC₈₀ ratios are expressed logarithmically so that 0 represents the line of unity, i.e., compounds on this line are equiactive against COX-1 and COX-2. Compounds appearing above the line are COX-1 selective; those below the line COX-2 selective. [From Warner and Mitchell (2004 Fig. 2, p. 193).]

lysosomal enzymes (beta glucuronidase and acid protease), which could also contribute to their anti-inflammatory properties and particular benefits in the treatment of osteoarthritis (Smith, 1978). This may be a COX-mediated effect through stabilization of lysosomal membranes. Certain agents have also been shown to inhibit activation of nuclear factor kappa B, a proinflammatory transcription factor, through the nitric oxide pathway, suggesting an additional mechanism for NASID anti-inflammatory activity (Bryant et al., 2003).

3. Therapeutic Activities and Side Effects of Analgesic-Antipyretic and Anti-Inflammatory Drugs

Analgesic-antipyretic and anti-inflammatory drugs have varied effects on pain, body temperature, and inflammation. For instance, acetaminophen is antipyretic and analgesic but is only weakly anti-inflammatory (Capetola et al., 1983).

As a class, these drugs are considered to be effective against pain of low-to-moderate intensity. However, it is important to consider the type and intensity of pain in assessing analgesic efficacy. These drugs are particularly effective in controlling the pain related to nociceptors that have been sensitized to normally painless mechanical, thermal, or chemical stimuli. According to Insel (1990), analgesic-antipyretic and anti-inflammatory drugs can be superior to the opioid analgesics in some forms of post-operative pain. Although it is generally believed that the pain arising from the hollow viscera is usually not relieved by aspirin-like drugs, future studies in this exceptionally active and intense area of investigation may modify this belief (Strigo et al., 2005).

Pharmacokinetic parameters of analgesic-antipyretic and anti-inflammatory drugs are influenced by whether they are acidic (most NSAIDs) or nonacidic (phenazone, acetaminophen,

celecoxib, rofecoxib) (Brune and Zeilhofer, 1999). The nonacidic drugs lack anti-inflammatory activity, and the anti-inflammatory activity of the acidic drugs has been attributed to their concentration in inflamed, acidic tissue (Graf et al., 1975). This demonstrates that pharmacokinetic as well as pharmacodynamic factors determine the clinical response to analgesic-antipyretic and anti-inflammatory drugs.

All analgesic-antipyretic and anti-inflammatory drugs are antipyretic, presumably via preventing PGE₂ production in the hypothalamus, which regulates the set point at which the body temperature is maintained (Saper and Breder, 1994). Inhibition of PGE₂ production returns the set point to normal (Dascombe, 1985).

Common side effects of analgesic-antipyretic and anti-inflammatory drugs are shown in Table 4-2. All these effects are generally thought to be mediated via the inhibition of COX. Although gastric ulceration may be caused by the local irritant effect of an orally administered drug, parenteral administration of analgesic-antipyretic and anti-inflammatory substances can also cause gastric and intestinal ulceration. PG inhibit acid secretion by the stomach and promote the secretion of cytoprotective mucus in the intestine. This protective function is blocked if PG synthesis is inhibited (Roberts and Morrow, 2001). Certain analgesic-antipyretic and anti-inflammatory drugs have also been shown to cause neutrophil adhesion in mesenteric blood vessels (Kirchner et al., 1997). It is possible that there is diapedesis of these cells into the tissues, resulting in inflammation and hence ulceration.

Synthesis in platelets of thromboxane A₂ (TxA₂), a platelet-aggregating agent, is inhibited by analgesic-antipyretic and anti-inflammatory drugs, resulting in increased bleeding times. Skin phototoxicity is a described family effect, but appears to

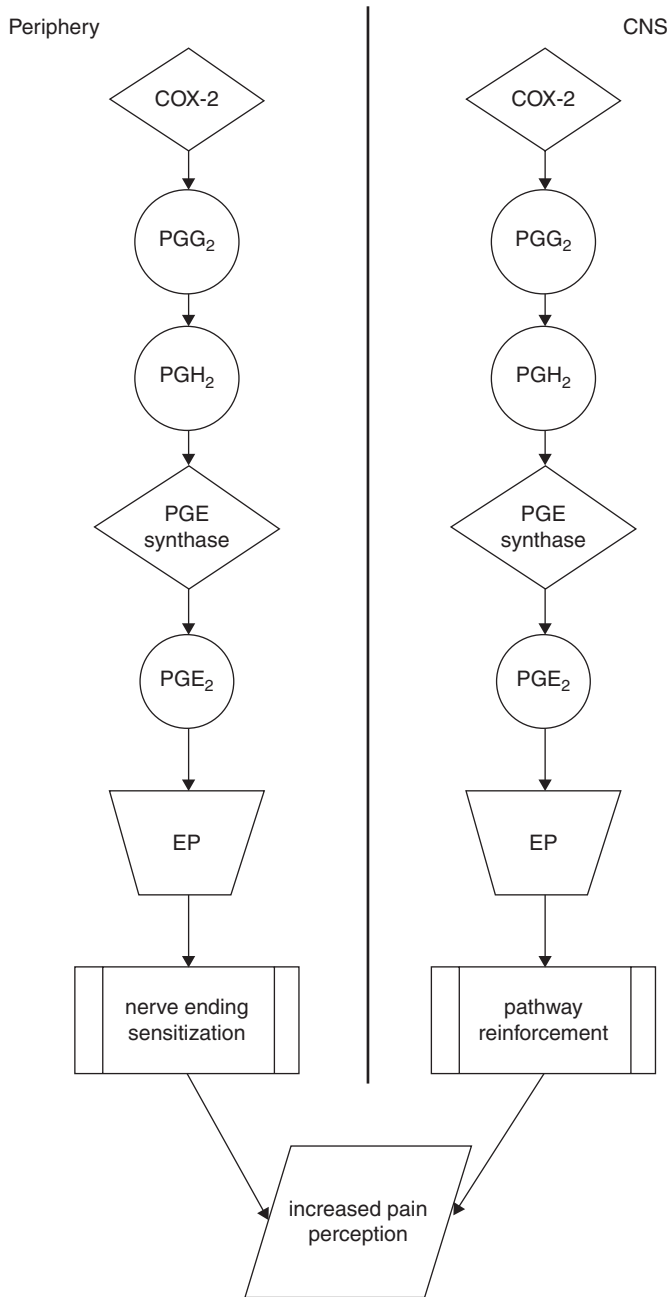

Fig. 4-4 Schematic pathway of roles of COX-2 in pain perception in the periphery and within the CNS. [From Warner and Mitchell (2004 Fig. 3, p. 194).]

be seen only at high doses and does not occur with all classes of analgesic-antipyretic and anti-inflammatory drugs. A beneficial side effect of PG synthesis inhibition, demonstrated experimentally for some of these drugs, is the prevention of colon carcinogenesis (Ota et al., 2002).

Caution should be exercised in giving analgesic-antipyretic and anti-inflammatory drugs to debilitated animals as these drugs may affect their renal function. In normal human subjects, these drugs have little effect on renal function. However, renal

TABLE 4-2

SIDE EFFECTS OF ANALGESIC-ANTIPYRETIC AND ANTI-INFLAMMATORY DRUGS

Gastric or intestinal ulceration
Disturbance of platelet function
Prolongation of gestation or spontaneous labor
Changes in renal function
Decrease renal blood flow and glomerular filtration
Promote action of antidiuretic hormone
Increase absorption of chloride
Enhance K ⁺ reabsorption
Suppress renin secretion

effects may occur in patients with congestive heart failure, hepatic cirrhosis with ascites, and chronic renal disease, or in those who are hypovolemic for any reason. In these conditions, renal perfusion is dependent on PG-induced vasodilation that opposes the norepinephrine- and angiotensin-II-mediated vasoconstriction resulting from the activation of pressor reflexes. Chronic abuse of any analgesic-antipyretic and anti-inflammatory drug or analgesic mixture may cause renal injury in susceptible individuals, although nephropathy is not commonly associated with the use of these drugs.

B. Salicylates

Despite the introduction of many new drugs, aspirin is still being widely used in humans for its antipyretic, analgesic, and anti-inflammatory action. Salicylates are derivatives of salicylic acid that are either esters of salicylic acid obtained by substitution in the carboxyl group or salicylate esters of organic acids in which the carboxyl group of salicylic acid is retained and substitution is made in the OH group. Aspirin is an ester of acetic acid.

In high doses, salicylates stimulate the CNS (including the production of seizures) followed by depression. Confusion, dizziness, tinnitus, high-tone deafness, delirium, psychosis, stupor, and coma may also occur (Roberts and Morrow, 2001).

Salicylates stimulate respiration both directly and indirectly. Therapeutic doses increase CO₂ production and O₂ consumption by uncoupling oxidative phosphorylation. The increased CO₂ production stimulates respiration. Salicylates also directly stimulate the respiratory center in the medulla. Both rate and depth of respiration increase, producing marked hyperventilation. In human adults, salicylates produce a respiratory alkalosis with resultant renal compensation. This includes increased renal excretion of bicarbonate, accompanied by Na⁺ and K⁺, which restores blood pH via lowered plasma bicarbonate. After high doses of salicylates or after prolonged exposure, medullary depression occurs, producing circulatory collapse secondary to vasomotor depression and respiratory depression. Respiratory acidosis results not only from the respiratory depression, but also from enhanced CO₂ production. No important

cardiovascular changes are seen following ordinary therapeutic doses (Roberts and Morrow, 2001).

Salicylates may also induce nausea and vomiting, probably via an effect on the medullary chemoreceptor trigger zone. Epigastric distress, nausea, and vomiting may be produced by ingestion of salicylates. High-dose therapy may cause gastric ulceration, GI hemorrhage, and erosive gastritis (Roberts and Morrow, 2001).

Salicylates may produce a dose-dependent hepatotoxicity, most commonly in humans with connective tissue disorders. There are usually no symptoms, and elevated serum transaminases are the principal laboratory findings. Hepatomegaly, anorexia, and nausea may be present in about 5% of humans with salicylate-induced hepatotoxicity (Roberts and Morrow, 2001).

The renal effects of salicylates were discussed earlier. Low doses of salicylates may decrease urate excretion and increase plasma urate concentrations. Moderate doses usually do not affect urate excretion, but higher doses may induce uricosuria. As discussed earlier, aspirin interferes with platelet aggregation, thereby prolonging the bleeding time. Hyperglycemia, glycosuria, and depletion of muscle and liver glycogen may be produced by large doses of salicylates. Toxic doses cause a significant negative nitrogen balance. Salicylates reduce lipogenesis, inhibit epinephrine-stimulated lipolysis in fat cells, and displace long-chain fatty acids from binding sites on human plasma protein (Roberts and Morrow, 2001).

1. Pharmacokinetics and Metabolism

a. Absorption

When administered orally to humans, salicylates are absorbed rapidly, partly by the stomach but mainly by the upper small intestine. Absorption varies among animal species. Davis and Westfall (1972) demonstrated that orally administered sodium salicylate is rapidly absorbed in dogs and swine, less so in ponies, and slowly absorbed in goats.

b. Distribution and Fate

Salicylates are distributed throughout the body, primarily by pH-dependent passive processes. They readily cross the placenta and are actively transported into the cerebrospinal fluid (CSF) across the choroid plexus by a low-capacity process. Up to 80–90% of salicylate is bound to plasma proteins, especially albumin.

Salicylate is biotransformed in many tissues, but especially in the hepatic endoplasmic reticulum and mitochondria. In humans, there are three primary metabolic products: salicylic acid (the glycine conjugate), the ether or phenolic glucuronide, and the ester or acyl glucuronide. Salicylates are excreted in the urine as free salicylic acid, salicylic acid, salicylic phenolic, acyl glucuronides, and gentisic acid. More than 30% of the

ingested drug may be eliminated as free salicylate in alkaline urine, but as low as only 2% may be excreted in acidic urine.

In humans, salicylate elimination is dose dependent because of the limited ability of the liver to form salicylic acid and the phenolic glucuronide. The plasma half-life for salicylate is 2–3 hours at low dose and about 12 hours in higher doses; the half-life for aspirin is about 2–3 hours. The rates of elimination of sodium salicylate following IV injection of 44 mg/kg to goats, ponies, swine, dogs, and cats were measured by Davis and Westfall (1972). Clearance was fastest in ponies and goats and slowest in cats (~30 times slower). The clearance rate in dogs and pigs was about midway between cats and ponies and goats. Differences in rates of biotransformation The given text has been rephrased for clarity of thought. Please check whether the intended meaning is retained: 'Although . . . was urine pH.', as well as urine pH, were important. The high clearance rate in ponies was due to rapid excretion in the alkaline urine of the species. The higher clearance rate in goats was associated with rapid biotransformation plus rapid clearance in alkaline urine.

According to Davis (1983), the half-life of IV sodium salicylate (44 mg/kg) is 37.6 hours in cats, 8.6 hours in dogs, 5.9 hours in swine, 1.03 hours in ponies, and 0.78 hours in goats. If the dosing interval is too short relative to the half-life of aspirin, toxicity will result. Dogs may be given aspirin twice daily, and cats twice weekly. However, it may take 2 weeks to obtain effective blood levels in the cat (Baggot, 1992; Hughes and Lang, 1983).

2. Preparations and Routes of Administration

Aspirin and sodium salicylate are the two most commonly used preparations of salicylate for systemic effects. They are usually administered orally. Sodium salicylate is available for parenteral use. Because aspirin is poorly soluble and has many chemical incompatibilities, it should only be administered in dry form.

Diflunisal appears to be a competitive inhibitor of COX, and is more potent than aspirin in anti-inflammatory tests in animals (Insel, 1990). It is primarily used as an analgesic in the treatment of osteoarthritis and musculoskeletal strains or sprains. The drug does not produce auditory side effects and has limited, if any, antipyretic activity. It is available as an oral preparation.

C. Pycazolone Derivatives

A number of drugs in this group have analgesic activity (e.g., antipyrine, oxyphenylbutazone, aminopyrine, dipyrone, apazone), but phenylbutazone is the most important from a therapeutic point of view.

Phenylbutazone has anti-inflammatory effects similar to those of salicylates. Its analgesic activity for pain of nonrheumatoid origin is inferior to that of salicylates. Phenylbutazone causes agranulocytosis, has a mild uricosuric effect, and causes

significant retention of Na^+ and Cl^- accompanied by a reduction in urine volume. It displaces other drugs bound to plasma protein.

1. Pharmacokinetics and Metabolism

Phenylbutazone is rapidly and completely absorbed from the GI tract or the rectum. More than 98% of the drug is bound to plasma proteins. In humans, phenylbutazone undergoes extensive biotransformation. Hydroxylation of the phenyl rings or the butyl side chain and glucuronidation are the most significant primary reactions. Active metabolites with long plasma half-lives are formed. Half-lives of phenylbutazone in several species are shown in Table 4-3. This drug, unlike salicylate, is slowly eliminated from ruminants. The reason for this is not known (Davis, 1983). As previously mentioned, dosing intervals must be adjusted relative to the half-life of the drug: the longer the half-life, the greater the dosing interval. In turn, the time taken to reach therapeutic blood concentration is lengthened.

2. Preparations and Route of Administration

Phenylbutazone is available as tablets, capsules, paste, gel, or a powder for oral administration, and as a parenteral product for injection.

D. *p*-Aminophenol Derivatives

Acetaminophen is a drug in this class that is of therapeutic interest. Its analgesic and antipyretic effects do not differ significantly from those of aspirin. Its weak anti-inflammatory effect has been noted earlier in this chapter. Acetaminophen is an active metabolite of phenacetin. Therapeutic doses of acetaminophen

have no effect on the cardiovascular and respiratory system and produce no acid–base changes. Acetaminophen has no effects on platelets, bleeding time, or excretion of uric acid, and does not produce gastric irritation, erosion, or bleeding.

The fact that acetaminophen has analgesic and antipyretic activity, but only weak anti-inflammatory action, indicates that anti-inflammatory activity is not essential for the analgesic action of aspirin-like drugs. The inflammatory process involves a series of events that can be elicited by numerous stimuli, and many mediators of the inflammatory process have been identified. A central as well as peripheral mechanism for analgesic activity has been recognized. Malmberg and Yaksh (1993) have demonstrated that analgesic–antipyretic and anti-inflammatory drugs modulate neuropathic pain at the spinal cord level.

1. Pharmacokinetics and Metabolism

Acetaminophen is rapidly and almost completely absorbed from the GI tract. Binding of the drug to plasma protein is variable. It is excreted in the urine as a conjugate of glucuronic acid or cysteine; small amounts of hydroxylated and deacetylated metabolites have also been detected. Up to 80–90% of the therapeutic dose may be recovered in the urine within 24 hours of administration.

2. Toxic Effects

Therapeutic doses of acetaminophen are usually well tolerated. Skin rash and other allergic reactions occur occasionally. A dose-dependent potentially fatal hepatic necrosis is the most serious adverse effect of acetaminophen overdose. Acute hypoglycemia and renal tubular necrosis may also occur. The use of acetaminophen in cats is contraindicated. Cats lack the ability to metabolize acetaminophen through glucuronidation, and methemoglobinemia will occur at dosages safe in other species.

3. Preparations and Routes of Administration

Acetaminophen is available commercially in the form of tablets, capsules, suppositories, chewable tablets, wafers, elixirs, and solutions, in combination with other drugs (e.g., opioids). Children's elixirs and suspensions have been used clinically in nonhuman primates, added to the drinking water of rodents with variable efficacy (Bauer et al., 2003; Cooper et al., 1997; Mickley et al., 2006; Speth et al., 2001).

E. Acetic Acid Derivatives

Indomethacin and sulindac are representative drugs of this class. Indomethacin is widely used and is effective, but toxicity often limits its use. Its antipyretic, analgesic, and anti-inflammatory activities are similar to those of salicylates. This is also true for sulindac, which is less than half as potent as indomethacin.

TABLE 4-3

HALF-LIVES OF PHENYLBUTAZONE IN SEVERAL SPECIES

Species	$t_{1/2}$ (hour)
Human	72
Ox	55
	42
Goat	
Female	19
Male	14.5
Cat	18
Rat	6
Dog	6
Swine	4
Baboon	5
Horse	3.5
Rabbit	3

Source: From Davis (1983 Table 2, p. 172).

Diclofenac is another drug in this family and has a pharmacologic profile similar to that of others. It is available in enteric-coated tablet form for oral administration. A topical cream is marketed for use in horses. Tolmetin is a similar drug that appears to be approximately equal in efficacy to aspirin, but usually better tolerated. It causes gastric erosion and prolongs bleeding time. In humans, it is rapidly absorbed following oral administration and is highly protein bound (99%) in plasma.

Ketorolac is pharmacologically similar to aspirin except that it does not irreversibly interfere with the platelet function. In patients suffering from chronic pain, the incidence of adverse GI side effects is slightly higher with ketorolac than with aspirin. Ketorolac is readily absorbed following oral or intramuscular (IM) administration and is highly bound to plasma protein (99%). In humans, the majority of ketorolac is excreted in the urine and may be accompanied by renal toxicity with repeated doses. Ketorolac has been shown to reduce prostaglandin E₂ and provide postoperative pain relief for at least 6 hours in rats (Kroin et al., 2006).

Etodolac is similar to ketorolac. It is approved for use in dogs and is available in tablets. Etodolac is thought to be a dual COX inhibitor with selectivity for COX-2. However, the data are inconsistent among studies (Clark, 2006). It may have more COX-2 selectivity in humans, but in dogs it appears to be slightly selective for COX-1 (Streppa et al., 2002). Because of this, etodolac may have a narrower safety margin than other NSAIDs labeled for use in dogs, such as carprofen and meloxicam (Clark, 2006). The manufacturer's information indicates that etodolac also inhibits macrophage chemotaxis.

1. *Pharmacokinetics and Metabolism*

Indomethacin, sulindac, and etodolac are rapidly and almost completely absorbed from the GI tract after oral administration. Indomethacin is 90% bound to plasma proteins. It is converted to inactive metabolites; 10–20% of the drug is excreted unchanged in the urine. Free and conjugated metabolites are eliminated in urine, bile, and feces. The metabolism and pharmacokinetics of sulindac are complex and vary enormously among species. It is a prodrug that must be metabolically changed to the active form (sulfide). About 90% of sulindac is absorbed in humans following oral administration.

Etodolac has a half-life of 7–12 hours in dogs and is labeled for once daily use to treat pain. In rats, etodolac undergoes enterohepatic circulation and has a half-life of 18 hours (Ogiso et al., 1997; Shi et al., 2004). It was effective in treating inflammation and neuropathic pain in rats (Suyama et al., 2004; Tachibana et al., 2003).

2. *Preparations and Route of Administration*

Oral dosage forms of indomethacin include regular and sustained-release capsules. It is also available as a suppository, as an oral suspension, and as an IV injection (the latter

for inducing closure of patent ductus arteriosus). Sulindac is available in tablet form. Tolmetin is supplied in the form of oral tablets and is approved in the United States for the treatment of osteoarthritis, rheumatoid arthritis, and the juvenile form of the disease in humans. Ketorolac tromethamine is available in the form of solution for parenteral injection and as tablets for oral administration. Etodolac is available in tablet form for oral use in dogs.

F. **Fenamates**

The only drugs in this family available in the United States are mefenamic acid and meclofenamate. Meclofenamate is used in the treatment of rheumatoid arthritis and osteoarthritis, but is not recommended as initial therapy. Meclofenamate has a higher degree of COX-2 selectivity in dogs than many other NSAIDs, but is still less COX-2 selective than carprofen (Streppa et al., 2002). Mefenamic acid is used for relief from symptoms of primary dysmenorrhea and for analgesia. The fenamates frequently cause side effects, especially diarrhea. They have no clear advantage over other aspirin-like drugs.

G. **Propionic Acid Derivatives**

Drugs in this family include ibuprofen, fenoprofen, flurbiprofen, flunoxaprofen, ketoprofen, naproxen, and carprofen. Carprofen and ketoprofen are important drugs in clinical laboratory animal medicine, because they are available as veterinary pharmaceuticals with labeling for companion and agricultural species that may be used in research, and because there are data available on laboratory rodents. Carprofen and ketoprofen have also been studied in birds. Ibuprofen and ketoprofen are important drugs in human medicine and therefore have a large body of literature relating to them. Most of these drugs are available in tablet form for oral administration, and also as parenteral formulations. Rectal administration of carprofen and ketoprofen has been investigated in dogs and horses, and may be viable when oral administration is not possible (Corveleyn et al., 1996; Schmitt and Gentert, 1990a, 1990b).

1. *Pharmacology*

Ketoprofen and ibuprofen inhibit both COX-1 and COX-2, with ketoprofen having a higher selectivity for COX-1 than ibuprofen in dogs (Streppa et al., 2002). Carprofen is claimed to be predominately a COX-2-selective drug, but it does inhibit COX-1 slightly. Carprofen demonstrates less COX-2 selectivity in cats than in dogs (Clark, 2006; Streppa et al., 2002). Carprofen may also directly stimulate glycosaminoglycan synthesis by chondrocytes (Benton et al., 1997). Metabolites of ketoprofen have also been shown to have activity against COX-1 and COX-2, and the selectivity of the metabolites is higher

for COX-2 than the parent drug (Levoine et al., 2004). There may be activity that is not mediated by COX inhibition. The R-enantiomer of ketoprofen does not have any COX inhibitory activity, but has been shown to have antinociceptive activity in humans (Cooper et al., 1998). Some analgesic effects of ketoprofen may be mediated by serotonergic and noradrenergic mechanisms at the supraspinal and spinal levels (Diaz-Reval et al., 2004; Pinardi et al., 2001).

2. *Effects and Toxicity*

The propionic acid derivatives are usually better tolerated by humans and animals than are aspirin, indomethacin, and pycazolone derivatives. The similarities between drugs in this class are more striking than are the differences. The compounds vary in their potency, but the difference is not of obvious clinical significance. Their efficacy against orthopedic and postoperative pain compares favorably in clinical studies with some opioids, such as buprenorphine, butorphanol, pethidine, and codeine. All have anti-inflammatory, analgesic, and antipyretic activity. They can cause GI erosions in experimental animals and produce GI side effects in humans and animals. This includes an increase in intestinal permeability (Davies et al., 1996). Most of these drugs can alter platelet function and prolong bleeding time. This effect in humans subsides within 24–36 hours with ketoprofen. Ketoprofen did not affect bleeding time in dogs in one study (Forsyth et al., 2000). Carprofen has been shown to affect platelet aggregation and increase activated partial thromboplastin time (APTT), but not bleeding time in dogs (Hickford et al., 2001). Carprofen can rarely cause elevation in liver enzymes and hepatic insufficiency in dogs. Increases in BUN and creatinine with ketoprofen administration have been reported in humans. Carprofen has been reported to cause minor changes in certain renal parameters, but most studies have not observed significant risk to renal function (Clark, 2006; Lobetti and Joubert, 2000). Carprofen and ketoprofen were not found to cause reproductive toxicity in rats at clinical dosages (McClain and Hoar, 1980). Naproxen is particularly potent in inhibiting migration and other functions of leukocytes.

3. *Pharmacokinetics*

Generally, propionic acid derivatives are rapidly absorbed and highly bound to plasma protein. They generally undergo biotransformation in the liver by glucuronidation, and the metabolites are excreted in the urine. However, in rats, biliary excretion of ketoprofen and flunoxaprofen metabolites is important, and significant enterohepatic recirculation occurs (Iwakawa et al., 1991; Meunier and Verbeeck, 1999; Yasui et al., 1996). Enterohepatic recirculation of carprofen also occurs in dogs. Metabolism and kinetics are stereoselective with variability between species (Maire-Gauthier et al., 1998). It is the S-enantiomer of carprofen and ketoprofen that are considered active against COX. Chiral inversion has been shown to

occur with ketoprofen from R to S in many species, and with flunoxaprofen in rats (Arifah et al., 2003; Iwakawa et al., 1991; Mauleon et al., 1994; Montoya et al., 2004; Yasui et al., 1996). Chiral inversion does not appear to occur with carprofen in dogs, cats, or rats, or with naproxen in rats (Cheng et al., 2003; Iwakawa et al., 1991; Taylor et al., 1996). Sex hormones also affect metabolism of ketoprofen, with testosterone apparently decreasing urinary excretion of glucuronidated S-ketoprofen in rats (Palylyk-Colwell and Jamali, 2004). The presence of arthritis affected metabolism of ketoprofen in rats, probably due to changes in serum albumin that increased the unbound fraction (Meunier and Verbeeck, 1999). Because of all of these factors, the plasma half-life of these drugs varies considerably among species. Despite this, the clinical effect appears to be prolonged in all species, even where the half-life is not (Table 4-4). This anomalous finding may be due to the presence of active metabolites of ketoprofen or prolonged effects on prostaglandin synthesis.

H. Oxicams

Piroxicam and meloxicam are available in the United States for human use. Piroxicam is similar to aspirin and most of the other aspirin-like drugs in many respects. Its distinguishing feature is a relatively long half-life, which permits administration once a day. It is usually considered to be contraindicated in cats. Compounds are available for oral administration.

Meloxicam is available in parenteral, tablet, and oral suspension forms and is labeled for treatment of osteoarthritis in dogs and postoperative pain in dogs and cats. It is at least as effective an analgesic as buprenorphine and more effective than butorphanol for postoperative pain resulting from soft-tissue surgery in dogs and cats (Clark, 2006). Meloxicam is a selective inhibitor of COX-2 in dogs and humans (selectivity for COX-2 ranging from 3 to 10 times that of COX-1, respectively), but is nonselective in cats (Clark, 2006; Streppa et al., 2002). Meloxicam does not affect bleeding time or clotting in dogs (Clark, 2006); it has a wide safety margin in dogs, particularly for prolonged use. However, GI side effects and other typical NSAID toxicities have been reported by the manufacturer. In cats, meloxicam should only be used as a single dose for postoperative pain, because longer use will result in GI side effects, as would be expected from the higher COX-1 activity in this species (Clark, 2006). Meloxicam has an elimination half-life of 12–24 hours in dogs and is labeled for once daily dosing (Montoya et al., 2004). It has a half-life of 3.2 hours when administered IV to chickens (Baert and De Backer, 2002).

I. Nicotinic Acid Derivatives

Flunixin is an anti-inflammatory analgesic approved for use in horses and cattle in the United States and also for use in dogs

TABLE 4-4
SERUM HALF-LIFE AND DURATION OF ACTIVITY OF SELECTED PROPIONIC ACID DERIVATIVE NSAIDS

Species	Half-life (hours)	Pharmacologic activity/clinical efficacy (hours)	References
Carprofen			
Dogs	4.5–9.8	24	Clark et al. (2006), Laredo et al. (2004), Pfizer Rimadyl® US Prescribing Information
Horses	8–24	47.5	Armstrong et al. (1999), Lees et al. (2002)
Cats	15–20	7–24	Taylor et al. (1996)
Sheep	26–33	32	Cheng et al. (2003), Welsh et al. (1992)
Cattle	30–64	36	Delatour et al. (1996), Lohuis et al. (1991), Ludwig et al. (1989)
Ketoprofen			
Dogs	1.65	12–20	Montoya et al. (2004)
Cats		24–72	Lees et al. (2003)
Cynomolgus	1.6–2.3		Mauleon et al. (1994)
Horses	1.89	24	Armstrong et al. (1999)
Cattle	0.26–1.5	24	Igarza et al. (2004), Landoni et al. (1995)
Sheep	0.63	12	Arifah et al. (2001)
Goats	1.8	24	Arifah et al. (2003)
Ducks	12		Machin et al. (2001)
Quail	6.5–7.4 minutes		Graham et al. (2005)
Rats	10–12	12	Cooper et al. (2005), Satterwhite and Boudinot (1992)
Flunoxaprofen			
Rats	69		AHFS (2007)
Naproxen			
Human	10–20		AHFS (2007)

in other countries. It demonstrates COX-1 selectivity in dog and horse blood (Brideau et al., 2001). It is usually formulated as flunixin meglumine. It is available in powder, pellet, and tablet form for oral administration and in liquid form for parenteral injection. It is used primarily in horses and agricultural animals for its antipyretic and anti-inflammatory activity. Of particular note is that it is labeled for use in lactating dairy cattle. According to Ciofalo et al. (1977), flunixin meglumine is a potent analgesic agent after parenteral administration in mice, rats, and monkeys and has historically been used in dogs and other laboratory animals. However, its use in these species has largely been replaced by newer, safer drugs. The kinetics and pharmacology have been described in ducks (Machin et al., 2001). It is significantly more potent than pentazocine, meperidine, and codeine in the rat yeast paw test after subcutaneous administration in saline, and demonstrates potency similar to that of other NSAIDs such as ketoprofen and carprofen. Vonderhaar and Salisbury (1993) presented the reports of cases involving administration of flunixin meglumine (1.1–2.3 mg/kg) to dogs via various routes and for various durations associated with gastroduodenal ulceration and perforation. They concluded that the use of flunixin meglumine is appropriate in the management of many conditions in dogs, but clinicians must be aware of potential adverse effects.

Serum half-life of flunixin is 1.2 hours in rabbits, 1.6 hours in horses, 2.5 hours in sheep, between 1.2 and 3.7 hours in dogs,

4 hours in goats, 3–5 hours in chickens, 6.6 hours in cats, 7.7 hours in swine, and 8.1 hours in cattle (Baert and De Backer, 2002; Buur et al., 2006; Cheng et al., 1998; Elmas et al., 2006; Hardie et al., 1985; Horii et al., 2004; Konigsson et al., 2003; Ogino et al., 2005). It is labeled for once daily dosing in cattle and horses, twice daily divided doses in cattle, and single injection only in swine. Flunixin does not reach blood levels in donkeys as high as in horses or mules (Coakley et al., 1999).

J. Alkanones

Nabumetone is an NSAID effective in treating fever, pain, and inflammation. It is available for human use as an oral tablet. It is a weak inhibitor of COX *in vitro*, but it is an active anti-inflammatory drug that possesses antipyretic and analgesic activities mediated via an active metabolite (Warner et al., 1999). The primary metabolite, 6-methoxy-2-naphthylacetic acid, is a potent nonselective inhibitor of cyclooxygenase and has an elimination half-life of about 24 hours in man. According to Roberts et al. (2001), nabumetone appears to cause less gastric damage than do other anti-inflammatory agents. After rapid gastric absorption, it is converted in the liver to one or more active metabolites. Its side effects are similar to those of salicylates.

K. Selective COX-2 Inhibitors

As shown in Table 4-1, COX-2 inhibitors are placed in four groups based on chemical structure (keep in mind that selective vs. nonselective COX inhibition is a relative term; see carprofen above).

Celecoxib is the only selective COX-2 inhibitor of the diaryl-substituted furanones available for human use in the United States. Two other drugs in this chemical class, deracoxib and firocoxib, are marketed in the United States for use in dogs to control pain and inflammation associated with osteoarthritis. Celecoxib and deracoxib are diaryl-substituted pyrazole derivatives. Firocoxib is a furanone derivative labeled for use in dogs, which is similar to rofecoxib, which was marketed for human use but was subsequently withdrawn from the market because of unacceptable cardiovascular side effects. These drugs are supplied as tablets for oral administration. Drugs in the group are highly protein bound. Peak blood concentrations of deracoxib occur 2 hours after oral administration; the elimination half-life at clinical dosages is 2–3 hours in dogs but the labeled dosing interval is once daily. In premarketing testing, adverse reactions were comparable in dogs receiving active drug and placebo. Deracoxib kinetics has been investigated in cats, and half-life is nearly 8 hours (Clark, 2006). The time taken for absorption of orally administered firocoxib is highly variable, with time to reach maximum blood concentration being 1–5 hours. Bioavailability is lower than with many analgesic–antipyretic and anti-inflammatory drugs. Serum half-life of firocoxib is 7.8 hours in dogs, and it is labeled for once daily use. In premarketing tolerance testing of firocoxib in dogs, small intestinal erosion and ulceration were observed. The margin of safety is thought to be extremely narrow in young dogs (Clark, 2006).

L. Dual Inhibitors of COX and LOX

Tapoxalin is an NSAID marketed for treatment of pain and inflammation in dogs that inhibits both COX enzymes, and enzymes in the LOX pathway. This additional activity is thought to increase the efficacy of the drug against inflammation, but also increases the scope of research models that may be affected by the administration of these drugs over those that affect COX alone. In addition to the normal effects of COX inhibition, inhibition of thromboxane and prostaglandin E₂ also decreases leukotriene concentrations in the blood and gastric mucosa. The manufacturer indicates that the drug is COX-1 selective for sheep COX, but it has not been tested against canine COX. This drug is available in a unique, rapidly disintegrating tablet form for dogs. Blood levels peak within 2 hours, and the half-life is only 2 hours. However, the metabolite is active and has a half-life of approximately 13 hours. The recommended dosing interval is once daily. The safety margin is considered wide. Tapoxalin does not affect the bleeding time in dogs. Also, it

TABLE 4-5

OPIOIDS

“Weak” opioids: Morphine-like agonists
Codeine
Oxycodone
Propoxyphene hydrochloride
Hydrocodone
Agonist–antagonists
Pentazocine
Nalbuphine
Butorphanol
“Strong” opioids: Morphine and morphine-like agonists
Morphine
Etorphine
Hydromorphone
Oxymorphone
Meperidine
Heroin
Levorphanol
Methadone
Sufentanil
Fentanyl
Remifentanil
Alfentanil
Partial agonist
Buprenorphine

does not cause neutrophil adhesion in mesenteric blood vessels as seen with other NSAIDs (Kirchner et al., 1997).

III. OPIOIDS

A. Overview

The opioids are classified as morphine and related opioids, meperidine and congeners, methadone and congeners, opioids with mixed actions such as agonist-antagonists and partial agonists, and opioid antagonists. Opioid analgesics may be classified in a number of different ways, each providing useful distinguishing characteristics of the drugs. Table 4-5 provides a listing of opioids grouped according to their relative analgesic potential. In this chapter, opioids are classified by molecular structure. The structures of morphine, meperidine, and methadone, the prototypic drugs for the different groups, are shown in Figure 4-5.

Abuse of opioids and addiction to them is of major concern. This concern in laboratory animal medicine primarily relates to diversion of drugs intended for patient administration to personnel having access to the drugs. Substantial effort in the development of opioids is aimed at reducing the abuse and addiction potential of opioids, as well as reducing the side effects such as respiratory depression and constipation.

The abuse potential of opioids, the required permits to purchase and administer opioids, and the storage and record-keeping requirements imposed by federal and state governments

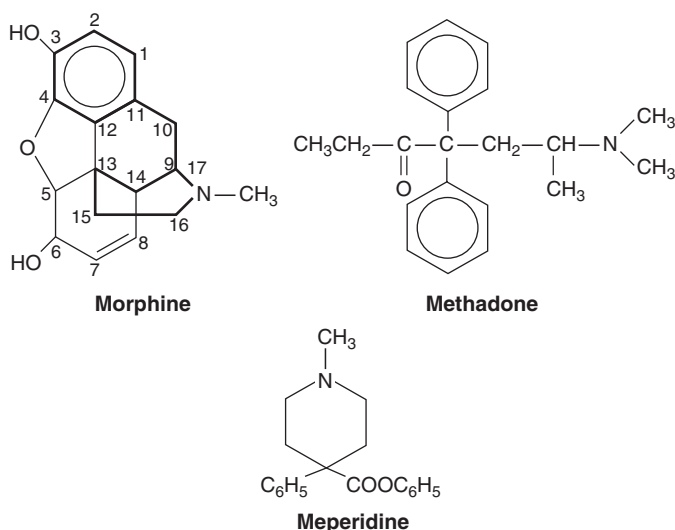

Fig. 4-5 Chemical structures of morphine, methadone, and meperidine.

often influence the decision of whether to administer these drugs to laboratory animals. Most opioids are classified as Schedule II Narcotics according to U.S. Drug Enforcement Agency documents (DEA Form 225a). Details of federal and state classifications and regulations of narcotics will not be discussed here.

The term “narcotic” as used in a legal sense includes opioids (as well as nonopioids, e.g., barbiturates), and the term generally has been used to refer to opioids. Thus, narcotic is derived from the word “narcosis” which refers to stupor or insensibility, obviously not usually the primary endpoint of opioid administration in most cases. The term narcotic is no longer a useful name for opioid analgesics in a pharmacological context. Opiate is a term once used to designate drugs derived from opium. Opioid is now used to designate those drugs plus all other drugs with morphine-like action.

1. History

The analgesic properties of poppy juice (opium) were recognized early in the history of mankind. *Papaver somniferum* is the plant from which poppy juice is extracted. Important to the modern developments in opioid pharmacology was the isolation of morphine from opium in 1806 by Sertürner and the more recent characterization and isolation of endogenous opioid substances and opioid receptors. Many semisynthetic derivatives of morphine are obtained by relatively minor modifications of morphine. The important properties of opioids that can be altered by structural modification are affinity for various subtypes of opioid receptors, agonistic versus antagonistic activity, lipid solubility, and resistance to metabolic breakdown.

2. Mechanism of Action

Opioids are formulated in a number of different ways, and administered for a variety of purposes by various routes. For

example, there are opioid patches (fentanyl) for transcutaneous delivery, injectable forms for IV, subcutaneous, im, epidural, and intrathecal administration and a formulation for opioid delivery through the oral mucosa. Opioids are administered to relieve acute, chronic, and cancer pain, as an immobilizing agent (etorphine), and as part of balanced anesthetic techniques that include administration, e.g., of an opioid, a hypnotic, and an amnesic agent. Usually, drugs with short half-lives (e.g., fentanyl, remifentanyl) are used for the balanced anesthetic technique. With increasing frequency, opioids are being administered alone or with local anesthetics for perioperative and intraoperative pain management.

Opioids produce their effects by binding to receptors. It is now generally accepted that there are at least three different receptors for opioids: mu, delta, and kappa (μ , δ , κ). As shown in Table 4-6, the receptors differ in varying degrees in their anatomic location and in the effect elicited when stimulated by an agonist. Also shown in Table 4-5 are examples of agonists that bind to the different receptors. A given opioid may interact with all of the receptor subtypes (Table 4-7). Analgesia is thought to involve the activation of μ receptors (largely at supraspinal sites) and κ receptors (mainly in the spinal cord), while δ receptors may also be involved.

Considerable interest exists in opioid receptors located on or near peripheral nerve endings and the action of opioids on these receptors to produce analgesia. Evidence favors an analgesic effect of opioids mediated by these receptors, but the effect appears to depend on the presence of inflammation (Czlonkowski et al., 1993). With increasing frequency, opioids are injected alone or with local anesthetics into the epidural or subarachnoid space to provide analgesia in animals. The rationale for using this route obviously is to place the opioid as close as possible to the spinal cord opioid receptors, thereby reducing the effective analgesic dose as well as the systemic side effects.

Repeated use of opioids may induce tolerance in some species. The development of tolerance will require adjustment of dosing to maintain efficacy. Tolerance develops at different rates to different pharmacologic effects. For example, tolerance to analgesic effects develops more rapidly than to respiratory effects, while tolerance to constipation develops very slowly, if at all. Therefore, if dosage is increased to compensate for the development of analgesic tolerance, this may increase the risk of respiratory depression or constipation (Shannon, 2007).

B. Morphine and Related Opioids

Morphine is the standard by which new analgesics are measured. Since it is relatively difficult to synthesize, it is obtained from opium or extracted from poppy straw. Related drugs important in laboratory animals and biomedical research are codeine, hydromorphone, hydrocodone, and oxycodone.

TABLE 4-6
OPIOID RECEPTORS

Receptor	Location	Action	Drug
Mu (μ)	Cerebral cortex (lamina IV), thalamus, periaqueductal gray	Mu-1: analgesia, Mu-2: respiratory depression, physical dependence	Morphine, fentanyl, codeine, naloxone
Delta (δ)	Frontal cortex limbic system, olfactory tubercule	Analgesia, respiratory depression, dependence	Enkephalin
Kappa (κ)	Spinal cord	Spinal analgesia sedation, low physical dependence	Dynorphin, mixed agonist/antagonists, (e.g., butorphanol nalbuphine), phencyclidine

TABLE 4-7
ACTIONS AND SELECTIVITIES OF SOME OPIOIDS AT THE VARIOUS OPIOID RECEPTOR CLASSES

	Receptor types		
	μ	δ	κ
<i>Drugs</i>			
Morphine	+++		+
Methadone	+++		
Etorphine	+++	+++	+++
Levorphanol	+++		
Fentanyl	+++		
Sufentanil	+++	+	+
Butorphanol	P		+++
Buprenorphine	P		--
Naloxone	---	-	--
Naltrexone	---	-	---
Diprenorphine	---	--	---
Nalorphine	---		+
Pentazocine	P		++
Nalbuphine	--		++

Source: Adapted from Gutstein and Akil (2001 Table 23-3).

Note: Activities of drugs are given at the receptors for which the agent has reasonable affinity. +, agonist; -, antagonist; P, partial agonist; DAMGO, CTOP, DPDPE, DSLET; see Table 4-6. The number of symbols is an indication of potency: the ratio for a given drug denotes selectivity. These values were obtained primarily from animal studies and should be extrapolated to human beings with caution. Both β -funaltrexamine and naloxonazine are irreversible μ antagonists, but β -funaltrexamine also has reversible κ agonist activity.

1. Pharmacological Properties

Morphine and chemically related opioid agonists produce their predominate analgesic action via μ receptors. However, they have notable affinity for the δ and κ receptors. In addition to analgesia, the effects include drowsiness, alteration of mood, respiratory depression, decreased GI motility, nausea, vomiting, and alterations of the endocrine and autonomic nervous systems. In humans, even large doses of morphine usually do not produce loss of consciousness, slurred speech, emotional lability, or significant motor incoordination. Oxymorphone is about 10 times as potent as morphine. According to Davis (1983), it has slight depressant effects on the CNS, and hence is more

advantageous than morphine and methadone in certain circumstances. It appeared to be more effective than buprenorphine at reducing behavioral changes following intestinal resection in rats (Gillingham et al., 2001).

This group of drugs relieves continuous dull pain more effectively than sharp intermittent pain (Jaffe and Martin, 1990). There are reports on patients stating that pain is still present after receiving an opioid but they are no longer uncomfortable. This is attributed, in part, to the fact that there is the sensory experience (nociception) as well as the reaction to the sensation that produces pain. Patients may report pain in the absence of nociception and vice versa. Pain evoked secondary to nerve damage (i.e., neuropathic pain) is poorly controlled by morphine and related drugs.

Species, strain, and gender differences in potency for some opioids, including morphine, hydromorphone, hydrocodone, and oxymorphone, have been reported in rats, with higher potency observed in males. (Bulka et al., 2004; Peckham and Traynor, 2006; Shannon, 2007; Terner et al., 2003). Gender differences in potency were not seen with codeine and oxycodone (Peckham and Traynor, 2006). Morphine does not appear to affect ruminant animals, the reason for which is still unknown (Davis, 1983).

Opioids may increase locomotor activity, while large doses may produce seizures in animals. Opioids are predominantly stimulatory in mice, cats, and horses, but produce behavioral depression in other species. Tolerance to the depressant effects can develop, unmasking behavioral stimulation in some species (Shannon, 2007). Buprenorphine, nalbuphine, and butorphanol cause an increase in activity in normal rats (Liles and Flecknell, 1992).

Morphine and oxymorphone can cause excitatory behavior in dogs (Robinson et al., 1988). Relatively large doses of morphine will cause a rage reaction in cats but lower doses can provide satisfactory analgesia. Morphine and related opioids suppress respiration via a direct effect on the brain stem respiratory centers primarily by reducing responsiveness to carbon dioxide. These drugs also suppress the cough reflex by a direct effect on the cough center in the medulla and may induce nausea and vomiting by direct stimulation of the chemoreceptor trigger zone in the area postrema of the medulla.

Morphine and morphine-like analgesics produce vasodilation, reduce peripheral resistance, inhibit baroreceptor reflexes, and blunt the reflex vasoconstriction caused by increased P_{CO_2} . These drugs may induce histamine release, but their cardiovascular effects are not dependent on histamine, although the effects are enhanced by histamine. In one study, morphine caused histamine release in dogs, but oxymorphone did not (Robinson et al., 1988). Codeine produces marked histamine release and hypotension when administered intravenously, and is contraindicated by this route (Shannon, 2007).

Morphine and other μ agonists usually decrease hydrochloric acid secretion in the stomach. Relatively low doses of morphine decrease gastric motility, thereby prolonging gastric emptying time. This drug decreases biliary, pancreatic, and intestinal secretions. The amplitude of nonpropulsive rhythmic, segmental contractions of the small and large intestines is usually enhanced, but propulsive contractions are markedly decreased in the small and large intestine. The tone of the anal sphincter is greatly augmented, and the reflex relaxation response to rectal distention is reduced. These actions, together with the central actions of morphine, contribute to morphine-induced constipation. Morphine causes constriction of the sphincter of Oddi, and pressure in the common bile duct may increase more than 10-fold. The fluid pressure in the gallbladder may also increase, producing signs that may vary from epigastric distress to biliary colic. Morphine inhibits the urinary voiding reflex, and both the tone of the external sphincter and the volume of the bladder are increased. Opioid-induced urinary retention and constipation do not appear to be clinically significant in rodents and rabbits (Flecknell, 1991).

Short-term (<120 hours) morphine administration has been shown to reduce natural killer (NK) activity (Bayer et al., 1990; Shavit et al., 1984), impair immunoglobulin production (Bussiere et al., 1992; Pruett et al., 1992), suppress phagocytic activity (Levier et al., 1993; Szabo et al., 1993), and induce thymic hypoplasia (Fuchs and Pruett, 1993). In monkeys and humans, use of chronic morphine is known to suppress NK activity (Carr and France, 1993; Novick et al., 1989).

2. Absorption

Generally, the opioids are readily absorbed from the GI tract. However, due to high first-pass removal by the liver, oral bioavailability is poor. The more lipophilic opioids are readily absorbed through the nasal or buccal mucosa, while those with the greatest lipid solubility can be absorbed transdermally. Opioids are readily absorbed after subcutaneous or IM injection and can enter the spinal cord following epidural or intrathecal administration.

3. Distribution and Fate

About one-third of the morphine in the blood is bound to plasma proteins. Compared with other more lipid-soluble

opioids such as codeine, heroin, and methadone, morphine crosses the blood-brain barrier at a slow rate; only small quantities pass the blood-brain barrier in adults. The major pathway for the metabolism of morphine is conjugation with glucuronide to form active as well as inactive products. Morphine-6-glucuronide is more potent than morphine, and morphine-3-glucuronide has antianalgesic activity. Morphine is eliminated from the body primarily via glomerular filtration. There are considerable species differences in the elimination of morphine. The elimination half-life of morphine is about 75 minutes in dogs and about 3 hours in cats (Davis, 1983). Morphine provides 3–4 hours of analgesia in rats and mice when administered subcutaneously (Gades et al., 2000). Hydromorphone has 4–4.5 hours of activity in dogs and nearly 6 hours in cats (Lascelles and Roberstson, 2004; Machado et al., 2006). Oxymorphone demonstrates 1.5–2 hours of activity in dogs (Machado et al., 2006). In rats, oxymorphone has a half-life of 1.5 hours when administered intravenously, and 1.3 hours when administered intranasally (Hussain and Aungst, 1997). Liposome encapsulation of oxymorphone for parenteral administration has been shown to significantly extend the duration of activity for up to 2 days in dogs, 3–5 days in parrots, 5 days in mice, and 2–7 days in rats (Clark et al., 2004; Krugner-Higby et al., 2003; Sladky et al., 2006; Smith et al., 2003, 2004).

In this group of drugs, the ratio of the oral to IM effective dose of codeine, levorphanol, and oxycodone is substantially higher than is the ratio for morphine. The reason is that the former drugs undergo less first-pass metabolism in the liver.

The analgesic effect of codeine is due to its conversion to morphine. Only a small fraction of codeine undergoes this conversion. Heroin readily crosses the blood-brain barrier, where it is rapidly hydrolyzed to 6-monoacetylmorphine (6-MAM), which is further metabolized to morphine. 6-MAM and morphine produce the pharmacologic actions of heroin.

4. Side Effects

Morphine and morphine-related opioids produce respiratory depression, nausea, vomiting, dizziness, mental clouding, increased pressure in the biliary tract, urinary retention, and hypotension. Allergic reactions to opioids may occur but they are not common. Morphine may cause increased locomotor activity and produce mania in cats. Pruritis, especially in facial areas, is a common sequela to epidurally or intrathecally administered opioids.

5. Preparation and Route of Administration

Solutions of morphine sulfate are available for oral use and for injection. Tablets, controlled-release tablets, and rectal suppositories are also available. Preservative-free solutions are intended for IV, epidural, or intrathecal injection.

Codeine sulfate and codeine phosphate are available in tablet form for oral administration. Codeine phosphate is available for

injection. Codeine is contained in numerous analgesic combinations (liquids, tablets, and capsules) and in various antitussive combinations (liquid and capsules). Codeine has no advantage over morphine when used parenterally. However, it is more advantageous when administered orally because of the high oral-to-IM effective dose ratio.

Oxymorphone is available for parenteral administration. Hydromorphone hydrochloride is available in tablets, rectal suppositories, and solution for IV injection. Oxycodone hydrochloride is available in tablets, as a solution for injection, and in combination with other analgesics. It is nearly equipotent 'Nearly' seems to be a better option here. Please check and confirm to morphine. Hydrocodone bitartrate is used in combination with other ingredients in antitussive and analgesic-antipyretic mixtures. Heroin is not available for therapeutic use in the United States. Levorphanol is available as levorphanol tartrate in tablets and as a solution for injection. Its clinical effectiveness in animals has not been established.

C. Meperidine and Congeners

Other drugs in this group are fentanyl, sufentanil, remifentanil, and alfentanil. Chemically, meperidine is classified as a piperidine. Its pharmacological activity is similar to, but not identical to, that of morphine. When given parenterally, meperidine is about one-tenth as potent as morphine. The oral-to-parenteral potency of meperidine is considerably higher than that of morphine. Meperidine has notable local anesthetic activity and anticholinergic effects.

Meperidine differs from morphine in that toxic doses cause CNS excitation, characterized by tremors, muscle twitching, and seizures. The meperidine metabolite normeperidine is mainly responsible for these effects. The effects of meperidine on smooth muscle are less intense relative to its analgesic actions, as compared to morphine, and meperidine does not cause as much constipation.

Fentanyl is approximately 80 times as potent as morphine. Higher doses produce marked muscular rigidity. It is usually used in combination with other drugs for anesthesia, but is also used for postoperative analgesia. Remifentanil and alfentanil were developed with the goal to have opioids with rapid onset and predictable termination of opioid effect. They are primarily used as part of a balanced anesthetic technique.

1. Absorption and Fate

Meperidine is absorbed by all routes but absorption may be erratic following IM injection. About 60% of the meperidine in blood is bound to the plasma protein. It is metabolized in the liver with only a small amount excreted unchanged. The duration of analgesia provided by Meperidine in the cat and dog is about 45 minutes (Davis, 1983). The half-life of meperidine in the cat is 0.7 hours because of rapid demethylation to normeperidine.

When administered intravenously to rats, fentanyl concentrations in brain, heart, and lung equilibrated rapidly with that in plasma, redistributed quickly into the muscle, more slowly into fat, and equilibrated with plasma levels in these tissues by 120 minutes after administration. Fentanyl was extensively metabolized in the liver and excreted in urine (Hug and Murphy, 1981).

Fentanyl has a half-life in dogs of only 45 minutes when administered IV, around 3 hours in the rhesus macaque, and 7.2 hours in the goat (Carroll et al., 1999; Sano et al., 2006; Valverde et al., 2000). The half-life in cats is between 2.3 and 6 hours, but it only provided analgesia against a thermal stimulus for <2 hours (Lee et al., 2000; Robertson et al., 2005). A blood level of >1.07 ng/mL was required to provide analgesia in cats (Robertson et al., 2005). Hypothermia decreased the efficacy of fentanyl in dogs, while hepatic insufficiency decreased the clearance of fentanyl in swine (Kostopanagioutou et al., 2006; Wilson et al., 2006).

In horses, therapeutic blood levels of transdermal fentanyl were reached within 1 hour of application, while it took 12–24 hours to reach the therapeutic levels in dogs (Egger et al., 1998; Gilberto et al., 2003; Maxwell et al., 2003). These levels were sustained in horses for up to 32 hours following a single patch, and a steady state was maintained at 48- or 72-hour patch application intervals (Maxwell et al., 2003). In dogs, the therapeutic levels lasted at least 72 hours, while in cats they were sustained for 5 days using a transdermal patch (Egger et al., 1998; Gilberto et al., 2003; Lee et al., 2000). In goats, blood levels from a transdermal patch were variable, but provided peak levels of up to 18 hours (Carroll et al., 1999).

Remifentanil is unique among drugs in this class as biotransformation is mediated by plasma esterases.

2. Preparations and Routes of Administration

Meperidine hydrochloride is available for oral use in the form of tablets and as a syrup and in solution for parenteral administration. Fentanyl citrate is available as a solution for injection and is supplied as a fixed-dose combination with droperidol for injection. Fentanyl patches for transcutaneous delivery are available for human use and are also being used to provide pain relief to animals. An oral form of fentanyl is available for transmucosal delivery. This has been used in Great Apes with varying levels of efficacy (Hunter et al., 2004). Intratracheal administration to rabbits resulted in a kinetic profile nearly identical to that for IV administration (Irazuzta et al., 1996). Sufentanil citrate and alfentanil hydrochloride are also very potent and relatively selective μ receptor agonists. They are used, usually in combinations with other drugs, for general anesthesia. They are also injected intrathecally and epidurally for postoperative analgesia.

3. Side Effects

The side effects of meperidine are similar to those of morphine, except that a meperidine metabolite may produce CNS

stimulation. Fentanyl causes respiratory depression in rats in a dose-related manner (Dahan et al., 2005).

D. Methadone and Congeners

Methadone is primarily a μ receptor agonist with pharmacologic properties similar to those of morphine. Notable properties of methadone include its oral efficacy, extended duration of action in suppressing withdrawal symptoms in physically dependent humans, and tendency to show persistent effects with repeated administration. About 90% of methadone is bound to plasma proteins. It undergoes extensive biotransformation in the liver. Methadone has a long plasma half-life (about 1–5 days in humans).

Propoxyphene binds to μ receptors with slightly less selectivity than morphine. As an analgesic, it is about one-half to two-thirds as potent as codeine given orally. The only recognized use of propoxyphene is for the treatment of pain that is not adequately relieved by aspirin.

1. Preparations and Routes of Administration

Methadone hydrochloride is available in the form of tablets and in solutions for oral use and as a solution for parenteral administration. Propoxyphene hydrochloride is available in the form of capsules, while propoxyphene napsylate as tablets or suspension for oral administration. Combinations of propoxyphene with aspirin or acetaminophen are marketed in the form of tablets and capsules.

E. Synthetic Opioid Agonists

Tramadol is a synthetic opioid agonist that is sometimes used in dogs for postoperative analgesia. Drug activity has been shown to be primarily due to the first metabolite (M1), which appears to be formed via CYP2D6 enzyme activity (Garrido et al., 2003). However, the parent drug also has some opioid activity, and it may also mediate pain relief by inhibition of norepinephrine and serotonin re-uptake. In rabbits, the half-life following IV administration is approximately 2 hours, (Kucuk et al., 2005). In dogs, the half-life is 0.9 and 1.7 hours, for IV and oral administration, respectively, while that for M1 it is 1.7 and 2.2 hours. A 4–6 hour dosing interval in dogs produced plasma concentrations of tramadol and M1 consistent with analgesic levels in humans (KuKanich and Papich, 2004).

F. Opioids with Mixed Actions: Agonist–Antagonists and Partial Agonists

Some opioids are competitive antagonists at the μ receptor, but exert partial agonistic actions at other receptors, including the δ and κ receptors (e.g., nalorphine, cyclazine, and

nalbuphine). Pentazocine is either a weak antagonist or a partial agonist of μ receptors and a relatively powerful κ receptor agonist. Buprenorphine is a partial μ agonist and κ antagonist.

Pentazocine differs from typical μ agonists, in that high doses cause an increase in blood pressure and heart rate. It does not antagonize respiratory depression produced by morphine, but it may produce withdrawal symptoms in patients who have been receiving μ -opioid receptor agonists. Pentazocine lactate is available as a solution for injection. Tablets containing pentazocine hydrochloride and naloxone hydrochloride are available for oral use. Naloxone is included to discourage the use of tablets as a source of injectable pentazocine. The naloxone absorbed after oral administration is rapidly removed by the liver.

Tablets containing pentazocine and aspirin or acetaminophen are also available. When given parenterally, three to six times as much pentazocine is required to equal the analgesic effect of a dose of morphine. Pentazocine is only slightly more potent than codeine when given orally. Ordinarily, there is a “ceiling” on the respiratory depressant effects of pentazocine (i.e., beyond a certain dose, respiratory depression increases little if at all).

Nalbuphine is an agonist–antagonist with a spectrum of effects similar to those of pentazocine except that nalbuphine is a more potent μ receptor agonist. Equal doses of nalbuphine and morphine given intramuscularly produce approximately equal analgesia. Nalbuphine has considerably less effect on the cardiovascular system than does pentazocine or butorphanol. Like pentazocine, there is a ceiling on the respiratory depressant effect of nalbuphine.

Butorphanol tartrate is available in solution for parenteral injection, and as tablets. Butorphanol has a pharmacologic profile similar to that of pentazocine. On a milligram-for-milligram basis, butorphanol is about three to five times as potent as morphine when given parenterally. However, analgesic efficacy has been reported to be less than that of morphine, oxymorphone, buprenorphine, ketorolac, or ketoprofen (Gades et al., 2000; Mathews et al., 1996; Pibarot et al., 1997; Robertson et al., 2003). When administered intravenously, the serum half-life is 82 minutes in cattle, 1.6 hours in rabbits and cats, and 3.2 hours in rabbits when administered subcutaneously (Court et al., 1992; Hosgood, 1990; Portnoy and Hustead, 1992). Analgesic efficacy lasted 2–6 hours in cats, and 1–2 hours in rats and mice (Gades et al., 2000; Lascelles and Robertson, 2004). Antitussive effect in cats lasted 8 hours longer than analgesic activity (Hosgood, 1990). In parrots, butorphanol provided 24 hours of analgesia administered intramuscularly, but when prepared in a liposome-encapsulated formulation, effects were seen for 3–5 days (Sladky et al., 1996).

Buprenorphine is widely used in laboratory animal medicine as (1) it has lower abuse potential than opioid agonists such as morphine and a relatively long duration of action, and (b) considerable data is available on its dosage and efficacy. Buprenorphine is a partial μ agonist. Buprenorphine has an inverted “U” dose–response curve for analgesia. Increasing dose increases efficacy up to a ceiling, the point at which the

antagonist properties predominate and begin to decrease analgesic activity (Heel et al., 1977). It produces analgesia and other CNS side effects that are similar to those produced by morphine. It causes increased motor activity in rats, and has been associated with abnormal eating behavior (pica) that could result in serious GI complications (Heel et al., 1977; Jablonski et al., 2000; Roughan and Flecknell, 2002; Stewart and Martin, 2003). Respiratory depression is seen with buprenorphine administration, but there is a ceiling effect above 3 mg/kg in rats (Dahan et al., 2005); decreased intestinal activity, decreased heart rate, and sedation are also reported. It can cause catalepsy in guinea. The text has been rephrased to put together related findings. Please check and confirm.pigs (Heel et al., 1977). It has been shown to have no significant effects on pregnancy in rats (Hutchings et al., 1995).

In recommended therapeutic doses, buprenorphine is about 25 times as potent as morphine when given intramuscularly, but only 6–10 times as potent when administered orally (Roughan and Flecknell, 2002). However, the maximum analgesic effect of buprenorphine is less than that of morphine and oxymorphone, but greater than that of butorphanol in nociceptive analgesiometric assays (Gades et al., 2000; Gillingham et al., 2001). In cats, buprenorphine was reported to be more effective than oxymorphone or ketoprofen in cats for onychectomy (Dobbins et al., 2002). In a model of incisional pain, buprenorphine showed greater efficacy than fentanyl, flunixin, or acetaminophen; various studies in cats and dogs have indicated analgesic efficacy following surgery to be similar to or better than that of other opioids, including morphine (Roughan and Flecknell, 2002; St. A. Stewart and Martin, 2003). However, studies in rats have not shown significant differences in analgesic efficacy following abdominal surgery between buprenorphine and NSAIDs like ketoprofen and carprofen (Cooper et al., 2005; Roughan and Flecknell, 2004; Sharp et al., 2003). Buprenorphine can produce withdrawal symptoms in patients who have been receiving μ receptor agonists (Heel et al., 1977). It antagonizes the respiratory depressant effects of some μ receptor agonists without completely preventing opioid pain relief.

About 96% of the drug in the plasma is protein bound and is mostly excreted unchanged in the feces in humans (Heel et al., 1977). In rats, buprenorphine is conjugated with glucuronide, excreted via the bile, and significant enterohepatic recirculation occurs. An active metabolite, norbuprenorphine, is also formed. The serum half-life of buprenorphine in rats is 2.8 hours while that of norbuprenorphine is 0.9 hours (Ohtani et al., 1994). Similar half-lives have been reported in mice, rabbits, and guinea pigs, except around 6 hours in cats and 19.5 hours in dogs, with another report listing a half-life of 7.7 hours in rats (Garrett and Chandran, 1985; Taylor et al., 2001; Yu et al., 2006). In rats, strain and gender differences in efficacy are known to occur, which may be accounted for by the differences in metabolism (Roughan and Flecknell, 2002).

Buprenorphine is available in solution for parenteral injection. It has a long duration of action: 3–5 hours in mice,

6–8 hours in rats, 6–7 hours in dogs, and 12–18 hours in cats (Dum and Herz, 1981; Gades et al., 2000; Robertson et al., 2003; Roughan and Flecknell, 2002). When administered orally, there is a significant first-pass liver effect, with at least a 5–10-fold increase in dose needed for oral administration (Cooper et al., 1997; Heel et al., 1977; Roughan and Flecknell, 2002; Slingsby et al., 2006).

G. Opioid Antagonists

Naloxone usually causes no effect unless opioids with agonistic action have been given. Small IM or IV doses of naloxone prevent or promptly reverse the effects of μ -opioid agonists. In dogs, naloxone reversed the effects of oxymorphone for 20–40 minutes following IV administration and for 40–70 minutes following IM administration (Copland et al., 1989). Naloxone hydrochloride is available in solution for parenteral injection. Other opioid antagonists are available, but naloxone is the most commonly used.

IV. α_2 -ADRENERGIC AGONISTS

A. Overview

α_2 -Adrenergic agonists can have diverse biological effects including sedation and loss of vigilance, and are discussed in Chapter 2 (MacDonald and Virtanen, 1992a; Table 4-8). Of particular relevance to this chapter is that these agents produce analgesia. Xylazine was introduced into veterinary medicine for sedation in the 1960s, but its mechanism of action was unknown. Later, it was concluded that it was a rather specific α_2 -adrenoreceptor agonist. α_2 -adrenoreceptor agonists used to modify animal pain include clonidine, xylazine, detomidine, medetomidine, and romifidine (Lemke, 2004). Detomidine and medetomidine are closely related imidazole derivatives; clonidine and romifidine are imidazoline derivatives, and xylazine is a thiazole.

1. History

α_2 -Adrenergic agonists were originally developed as antihypertensives and are currently being developed for IV administration for general anesthesia. Discovery of the role of a noradrenergic inhibitory system in nociception modulation at the spinal cord level provided a basis for the development of α_2 -adrenoreceptor agonists as receptor-specific analgesics, although the receptor-specific α_2 -receptor agonists developed to date are not effect-specific. Clonidine was synthesized in the early 1960s; about the same time xylazine was introduced into veterinary medicine. The α_2 -adrenergic agonist activity of xylazine was recognized in 1977 (Berthelsen and Pettinger, 1977; Hsu, 1981) and, shortly thereafter, Farnos Gropu Ltd. (Turku, Finland) produced detomidine and medetomidine.

TABLE 4-8
RESULTS OF α_2 -ADRENORECEPTOR STIMULATION

System or characteristic	Effect
CNS	Sedation, analgesia, hypotension, bradycardia
CVS	Peripheral vasoconstriction → initial hypertension, central bradycardia, and vasomotor depression → hypotension
Gut	Relaxation, decreased motility
Salivation	Decreased
Gastric secretion	Reduced
Uterus	Stimulation
Eyes	Mydriasis, decreased intraocular pressure
Hormones	Reduced release of insulin, renin, and antidiuretic hormone
Platelets	Aggregation

Source: From Hall and Clarke (1991 Table 4-1, p. 58).

2. Mechanism of Action

The α_2 -adrenergic receptors are located in tissues throughout the body. They exist presynaptically and postsynaptically in neuronal and non-neuronal tissues, and extrasynaptically in the vasculature as the endogenous ligand for these receptors is norepinephrine. In general, sedation and anxiolysis induced by α_2 -adrenergic agonists occur by actions in a small group of neurons in the brain stem, the locus coeruleus (Lemke, 2004). The analgesic effects are mediated by the activation of receptors in the spinal cord dorsal horn. Descending modulation of nociceptive input due to α_2 -receptor activation in the pons also plays a prominent role. The α_2 -adrenergic agonists appear to have a combined effect of presynaptic inhibition of afferent transmitter release from C fibers and a postsynaptic inhibition of spinal cord dorsal horn transmission neurons.

3. Therapeutic Activities and Side Effects

The α_2 -adrenergic agonists are used in laboratory animal medicine not only for their analgesic action but also for their sedative action. Used at low doses, these agents dramatically reduce the amount of general anesthetic required to induce and maintain anesthesia. α_2 -Adrenergic agonists are used in relatively large doses to induce sedation, analgesia, and immobilization. Their action is rapidly reversed by α_2 -antagonists.

As shown in Figure 4-6 and Table 4-8, systemically administered α_2 -adrenergic agonists produce a spectrum of behavioral effects, the most readily apparent being sedation and loss of vigilance. There is great variability in (1) the extent of sedation produced by different drugs and (2) responses of different animal species to the drugs. For example, dexmedetomidine and medetomidine can induce loss of the righting reflex in young chicks (Savola et al., 1986), but only medetomidine does so in rats. Medetomidine does not produce such deep sedation in mice and rabbits. The dose response for this drug in rabbits is poor, and there are differences in responses between strains (Avsaroglu et al., 2003).

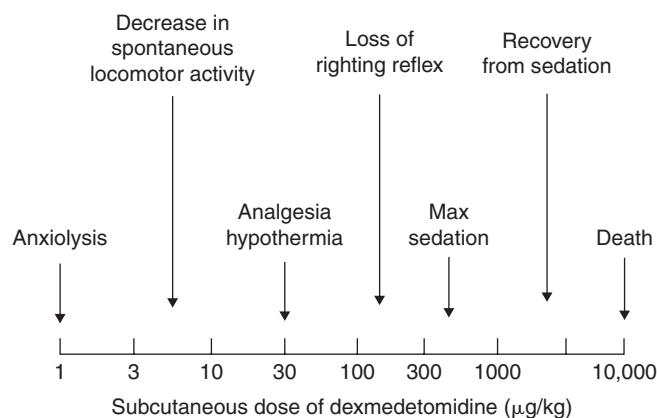

Fig. 4-6 Central actions of dexmedetomidine in rats after subcutaneous treatment. Dexmedetomidine is the dextro(+) isomer of medetomidine and is the active component of the racemic mixture. [From MacDonald and Virtnen (1992a Fig. 9-4, p. 186).]

The analgesic action of α_2 -adrenergic agonists is most clearly demonstrated following epidural or intrathecal injection. When administered systemically, they also have analgesic activity (e.g., inhibit acetic-acid-induced writhing or tail-flick responses to heat), but there is difficulty in distinguishing true analgesia from the inability to respond to painful stimuli. In rats, medetomidine was shown to reduce allodynia and mechanical and thermal hyperalgesia in a dose-dependent manner. This effect was more pronounced in animals with intact cerebral-spinal pathways than in animals that were spinalized (Molina and Herrero, 2006). Clinically, the α_2 -adrenergic agonists appear to have limited analgesic activity when used alone.

Common side effects of α_2 -adrenergic agonists include inhibition of insulin secretion and, hence, production of hyperglycemia. Low doses of these drugs decrease arterial blood pressure and heart rate, and may produce atrioventricular conduction block. Heart rate continues to slow down as the dose

increases, but blood pressure may increase. The effects on heart rate persist in dogs for approximately 6 hours following administration (Väisänen et al., 2005). Similar cardiac effects are seen in the rhesus macaque (Capuano et al., 1999). In cats, medetomidine decreased cardiac index, stroke index, rate-pressure product, and right and left ventricular stroke work index, while systemic vascular resistance and central venous pressure increased. Arterial pressures, pH, oxygen, and carbon dioxide tensions were not affected (Lamont et al., 2001). In horses, medetomidine, detomidine, and xylazine caused atrioventricular block, slightly decreased heart rate, and significant decreases in cardiac index and stroke volume. Hypertension was seen initially, but then blood pressure decreased with most treatments (Yamashita et al., 2000). Anticholinergic premedication has been recommended to reduce cardiovascular side effects; however, the benefits of this are not clear (Sinclair, 2003).

The α_2 -adrenergic agonists produce hypothermia and respiratory depression. They also produce emesis in a number of animal species (e.g., dog, cat). Other reported side effects of medetomidine include mydriasis, increased urine volume, changes to endocrine function and uterine activity, decreased intestinal motility, decreased intraocular pressure, and muscle twitching (Hsu et al., 1981; Sinclair, 2003). Medetomidine increased the low-frequency EEG activity in dogs and decreased high-frequency activity (Itamoto et al., 2001). In rats, xylazine was shown to decrease seizure threshold and increase the length and severity of seizures at lower doses, but had anticonvulsant activity at higher doses (Joy et al., 1983). In ferrets, medetomidine did not cause the elevations in pituitary and adrenocortical hormones normally seen with isoflurane anesthesia (Schoemaker et al., 2003).

Because of the wide range of effects of α_2 -adrenergic agonists, there is potential for them to interact with many other drugs. The doses of barbiturates, inhalational anesthetics, and dissociative anesthetics should be reduced when given along with α_2 -adrenergic agonists. It is common to administer α_2 -adrenergic agonists with other drugs to take advantage of synergistic interactions (e.g., along with local anesthetic via epidural or subarachnoid route, or with ketamine or opioid via IV or IM route).

4. Pharmacokinetics and Metabolism

a. Absorption

In general, clonidine is well absorbed after oral administration, and bioavailability is nearly 100%. However, the systemic availability of detomidine, medetomidine, and xylazine by the oral route is low. Few studies on the bioavailability of detomidine, medetomidine, and xylazine following IM administration reveal species variability (e.g., bioavailability good for detomidine in cattle and horses, good for xylazine in dogs but not horses).

b. Distribution and Fate

The α_2 -adrenergic agonists are lipophilic and hence are readily distributed into tissues. Approximately 85% of detomidine and medetomidine and about 70% of xylazine and clonidine are bound to plasma protein.

Generally, detomidine, medetomidine, and xylazine are eliminated relatively rapidly in all animal species. The half-life of elimination varies between 0.5 hours (xylazine in dogs, and medetomidine in sheep and goats) and 1.5 hours (medetomidine and detomidine in horses and dogs) (Kastner et al., 2003, 2006). The effects on allodynia and hyperalgesia in rats were greatly reduced within 1 hour of administration (Molina and Herrero, 2006). In goats, recumbency is seen within 1.5 minutes of IV administration and persisted for at least 2 hours (Carroll et al., 2005). Medetomidine sedation in rabbits lasts up to 30 minutes longer than xylazine when used in combination with ketamine and buprenorphine (Difilippo et al., 2004).

All four of the agonists are biotransformed primarily by the liver and then the metabolites are excreted in the urine. With the exception of clonidine, renal clearance of the unchanged drug is insignificant.

5. Preparations and Routes of Administration

Xylazine is available commercially as a 2 or 10% solution for IV or IM injection. Detomidine is available in injectable form (1% solution) for use in horses, and injectable medetomidine is approved for use in dogs and cats. Romifidine (1% solution) is approved for use in horses. It has a slower onset of action and a much longer duration of action than does either xylazine or medetomidine. No formulations are prescribed for epidural or intrathecal administration by veterinarians. Agents marketed for IV or IM administration contain preservatives that may be unsuitable for epidural or intrathecal administration.

B. α_2 -Adrenergic Antagonists

The α_2 -adrenergic antagonists in clinical use today include yohimbine, tolazoline, idazoxan, and atipamezole. Yohimbine, tolazoline, and atipamezole are approved for veterinary use in the United States. The obvious value of antagonists is to reverse overdose or hasten recovery from the sedative effects of α_2 -adrenergic agonists.

V. NMDA-RECEPTOR ANTAGONISTS

The discovery of the *N*-methyl-D-aspartate (NMDA) receptor and its role in pain perception increased interest in NMDA-receptor antagonists as potential analgesic agents. Commercially available NMDA-receptor antagonists include ketamine,

dextromethorphan, and ketobemidone. They have significant impact on the development of tolerance to opioid analgesics and are thought to interfere with the conversion of acute pain to chronic pain. NMDA-receptor antagonists are also discussed in Chapter 2 because some are used to produce “dissociative” anesthesia, which may be caused by pharmacological activity other than or in addition to NMDA-receptor antagonism.

A. History

Ketamine was developed in 1962 as a fast-acting general anesthetic. It was classified as a dissociative anesthetic because it produces a state wherein the patient appears to be conscious but detached from what is happening. It was noted to have analgesic action, especially against pain of somatic origin. Dextromorphan has been marketed for its antitussive action for many years.

B. Mechanism of Action

NMDA receptors are distributed widely in the body. NMDA receptors are involved in normal synaptic transmission but are primarily involved with the induction of various forms of synaptic plasticity, including the medium- and long-term changes observed in the transition from acute to chronic pain. Examples of these include “wind-up” facilitation, central sensitization, changes in peripheral receptive fields, induction of oncogenes, and long-term potentiation (Cousins and Power, 1999). Thus, it appears that NMDA antagonists can attenuate these responses and thus have a role in the treatment of acute pain and the prevention of chronic pain states.

C. Preparation and Routes of Administration

Dextromorphan is a common ingredient in various antitussive formulations. Ketamine is marketed in injectable form in various concentrations. Drugs in this category are by no means selective analgesics. However, because of the unique analgesic action of NMDA-receptor antagonists, there is considerable interest in developing selective drugs that might be used specifically for pain control.

VI. ANALGESIC ADJUVANTS

A list of drug classes used as analgesic adjuvants is shown in Table 4-9. These drugs are not reported to have analgesic activity but may be of benefit in the treatment of pain by, e.g., aiding sleep and countering depression and/or anxiety, muscle spasms, or inflammation. Drugs (e.g., antibiotics) used to treat

TABLE 4-9
ANALGESIC ADJUVANTS

Tricyclic antidepressants
Anticonvulsants
Antihistamines
Benzodiazepines
Sedative hypnotics
Steroids
Caffeine
Dextroamphetamines
Phenothiazines

conditions that produce pain such as bacterial infection may be classed as analgesic adjuvants. There is evidence that sedative hypnotics may have antianalgesic activity at low doses (Archer et al., 1994).

VII. FUTURE PROSPECTS

Efforts in four areas of research will strongly influence the management of pain in laboratory animals in the future. These areas are (1) understanding of pain mechanisms; (2) advances in optimization of alternative routes of drug administration, especially transmucosal, transcutaneous, epidural, and spinal; (3) improved methods for pain assessment; and (4) improved methods for assuring optimal dosing regimens, e.g., simple, rapid measurement of drug concentration in blood. The reader is referred to other chapters in this book that address several of these areas.

Of particular interest at this time are drugs that affect NMDA receptors at the spinal level. Activation of these receptors produces “wind-up” in dorsal horn neurons, a phenomenon linked to secondary algesia. NMDA-receptor antagonists are viewed as being particularly useful as preemptive agents (i.e., administered in anticipation of injury instead of afterward).

ACKNOWLEDGMENT

The authors thank Lela Shook Paksoy for technical assistance with the production of this chapter, and Dr. Harlan Shannon for scientific review of the manuscript.

REFERENCES

- American Hospital Formulary Service. (2007). 28:08 central nervous system agents. *In* “AHFS Drug Information.” (G.K. McEvoy, ed.). American Society of Health-System Pharmacists, Inc., Bethesda, MD.
- Archer, B.P., Erven, A., Roth, S.H., and Samanani, N. (1994). Plasma, brain and spinal cord concentrations of thiopental associated with hyperanalgesia in the rat. *Anesthesiology* **80**, 168–176.

- Arifah, A.K., Landoni, M.F., Frean, S.P., and Lees, P. (2001). Pharmacodynamics and pharmacokinetics of ketoprofen enantiomers in sheep. *Am. J. Vet. Res.* **62**, 77–86.
- Arifah, A.K., Landoni, M.F., and Lees P. (2003). Pharmacodynamics, chiral pharmacokinetics and PK-PD modeling of ketoprofen the goat. *J. Vet. Pharmacol. Ther.* **26**, 139–150.
- Armstrong, S., Tricklebank, P., Lake, A., Frean, S., and Lees, P. (1999). Pharmacokinetics of carprofen enantiomers in equine plasma and synovial fluid—A comparison with ketoprofen. *J. Vet. Pharmacol. Ther.* **22**, 196–201.
- Avsaroglu, H., Versluis, A., Hellebrekers, L.J., Haberham, Z.L., van Zutphen, L.F.M., and van Lith, H.A. (2003). Strain differences in response to propofol, ketamine and medetomidine in rabbits. *Vet. Rec.* **152**, 300.
- Ayoub, S.S., Botting, R.M., Goorha, S., Colville-Nash, P.R., Willoughby D.A., and Ballou, L.R. (2004). Acetaminophen-induced hypothermia in mice is mediated by a prostaglandin endoperoxide synthase 1 gene-derived protein. *Proc. Natl. Acad. Sci. U.S.A.* **101**, 11165–11169.
- Baert, K., and De Backer, P. (2002). Disposition of sodium salicylate, flunixin and meloxicam after intravenous administration in broiler chickens. *J. Vet. Pharmacol. Ther.* **25**, 449–453.
- Baggot, J.D. (1992). Clinical pharmacokinetics in veterinary medicine. *Clin. Pharmacinet.* **22**, 254–273.
- Bauer, D.J., Christenson, B.A., Clark, K.R., Powell, S.K., and Swain, R.A. (2003). Acetaminophen as a postsurgical analgesic in rats: a practical solution to neophobia. *Contemp. Top. Lab. Anim. Sci.* **42**(2), 20–25.
- Bayer, B.M., Daussin, S., Hernandez, M., and Irvin, L. (1990). Morphine inhibition of lymphocyte activity is mediated by an opioid dependent mechanism. *Neuropharmacology* **29**, 369–374.
- Benton, H.P., Vasseur, P.B., Broderick-Villa, G.A., and Koolpe, M. (1997). Effect of carprofen on sulfated glycosaminoglycan metabolism, protein synthesis, and prostaglandin release by cultured osteoarthritic canine chondrocytes. *Am. J. Vet. Res.* **58**, 286–292.
- Berthelsen, S., and Pettinger, W.A. (1977). A functional basis for classification of α_2 -adrenergic receptors. *Life Sci.* **21**, 596.
- Brideau, C., Van Staden, C., and Chan, C.C. (2001). In vitro effects of cyclooxygenase inhibitors in whole blood of horses, dogs, and cats. *Am. J. Vet. Res.* **62**, 1755–1760.
- Brune, K., and Zeilhofer, H.U. (1999). Antipyretic (non-narcotic) analgesics. In "Textbook of Pain." (P.D. Wall and R. Melzack, eds.), pp 1139–1153. Churchill Livingstone, Edinburgh.
- Bryant, C.E., Farnfield, B.A., and Janicke, H.J. (2003). Evaluation of the ability of carprofen and flunixin meglumine to inhibit activation of nuclear factor kappa B. *Am. J. Vet. Res.* **64**, 211–215.
- Bulka, A., Kouya, P.F., Bottiger, Y., Svensson, J.O., Xu, X.J., and Wiesenfeld-Hallin, Z. (2004). Comparison of the antinociceptive effect of morphine, methadone, buprenorphine and codeine in two substrains of Sprague–Dawley rats. *Eur. J. Pharmacol.* **492**, 27–34.
- Bussiere, J.L., Adler, M.W., Rogers, T.J., and Eisenstein, T.K. (1992). Differential effects of morphine and naltrexone on the antibody response in various mouse strains. *Immunopharmacol. Immunotoxicol.* **14**, 657–673.
- Buur, J.L., Baynes, R.E., Smith, G., and Riviere, J.E. (2006). Pharmacokinetics of flunixin meglumine in swine after intravenous dosing. *J. Vet. Pharmacol. Ther.* **29**, 437–440.
- Capetola, R.J., Rosenthale, M.E., Dubinsky, B., and McGuire, J.L. (1983). Peripheral antialgesics: A review. *J. Clin. Pharmacol.* **23**, 545–556.
- Capuano, S.V. III, Lerche, N.W., and Valverde, C.R. (1999). Cardiovascular, respiratory, thermoregulatory, sedative, and analgesic effects of intravenous administration of medetomidine in rhesus macaques (*Macaca mulatta*). *Lab. Anim. Sci.* **49**, 537–544.
- Carr, D.J.J., and France, C.P. (1993). Immune alterations in morphine-treated rhesus monkeys. *J. Pharmacol. Exp. Ther.* **267**, 9–15.
- Carroll, G.L., Hartsfield, S.M., Champney, T.H., Geller, S.C., Martinez, E.A., and Haley, E.L. (2005). Effect of medetomidine and its antagonism with atipamezole on stress-related hormones, metabolites, physiologic responses, sedation, and mechanical threshold in goats. *Vet. Anaesth. Analg.* **32**, 147–157.
- Carroll, G.L., Hooper, R.N., Boothe, D.M., Hartsfield, S.M., and Randall, L.A. (1999). Pharmacokinetics of fentanyl after intravenous and transdermal administration in goats. *Am. J. Vet. Res.* **60**, 986–991.
- Cheng, Z., McKeller, Q., and Nolan, A. (1998). Pharmacokinetic studies of flunixin meglumine and phenylbutazone in plasma, exudate and transudate in sheep. *J. Vet. Pharmacol. Ther.* **21**, 315–321.
- Cheng, Z., Nolan, A., and McKellar, Q.A. (2002). Anti-inflammatory effects of carprofen, carprofen enantiomers, and *N*(G)-nitro-L-arginine methyl ester in sheep. *Am. J. Vet. Res.* **63**, 782–788.
- Cheng, Z., Nolan, A., Montiero, A., and McKellar, Q.A. (2003). Enantioselective pharmacokinetics and cyclooxygenase inhibition of carprofen and carprofen enantiomers in sheep. *J. Vet. Pharmacol. Ther.* **26**, 391–394.
- Ciofalo, V.B., Latranyi, M.B., Patel, J.B., and Taber, R.I. (1977). Flunixin meglumine: A non-narcotic analgesic. *J. Pharmacol. Ther.* **200**, 501–507.
- Clark, M.D., Krugner-Higby, L., Smith, L.J., Heath, T.D., Clark, K.L., and Olson, D. (2004). Evaluation of liposome-encapsulated oxymorphone hydrochloride in mice after splenectomy. *Comp. Med.* **54**, 558–563.
- Clark, T.P. (2006) The clinical pharmacology of cyclooxygenase-2-selective and dual inhibitors. *Vet. Clin. N. Am. Small Anim. Pract.* **36**, 1061–1085.
- Coakley, M., Peck, K.E., Taylor, T.S., Matthews, N.S., and Mealey, K.L. (1999) Pharmacokinetics of flunixin meglumine in donkeys, mules, and horses. *Am. J. Vet. Res.* **60**, 1441–1444.
- Cooper, D.M., DeLong, D., and Gillett, C.S. (1997). Analgesic efficacy of acetaminophen and buprenorphine administered in the drinking water of rats. *Contemp. Top. Lab. Anim. Sci.* **36**, 58–62.
- Cooper, D.M., Hoffman, W., Wheat, N., and Lee, H. (2005). Duration of effects on clinical parameters and referred hyperalgesia in rats after abdominal surgery and multiple doses of analgesic. *Comp. Med.* **55**, 344–353.
- Cooper, S.A., Reynolds, D.C., Reynolds, B., and Hersh, E.V. (1998). Analgesic efficacy and safety of (*R*)-ketoprofen in post-operative dental pain. *J. Clin. Pharmacol.* **38**, 11S–18S.
- Copland, V.S., Haskins, S.C., and Patz, J. (1989). Naloxone reversal of oxymorphone effects in dogs. *Am. J. Vet. Res.* **50**, 1854–1858.
- Corvelyn, S., Deprez, P., Van der Weken, G., Baeyens, W., and Remon, J.P. (1996). Bioavailability of ketoprofen in horses after rectal administration. *J. Vet. Pharmacol. Ther.* **19**, 359–363.
- Court, M.H., Dodman, N.H., Levine, H.D., Richey, M.T., Lee, J.W., and Hustead, D.R. (1992). Pharmacokinetics and milk residues of butorphanol in dairy cows after single intravenous administration. *J. Vet. Pharmacol. Ther.* **15**, 28–35.
- Cousins, M., and Power, I. (1999). Acute and postoperative pain. In "Textbook of Pain." (P.D. Wall and R. Melzack, eds.), 4th ed., pp 447–491. Churchill Livingstone, Edinburgh.
- Cui, J.G., Kuiroda, H., Chandrasekharan, N.V., Pelaez, R.P., Simmons, D.L., Bazan, N.G., and Lukiw, W.J. (2004). Cyclooxygenase-3 gene expression in Alzheimer hippocampus and in stressed human neural cells. *Neurochem. Res.* **29**, 1731–1737.
- Czlonkowski, A., Stein, C., and Herz, A. (1993). Peripheral mechanisms of opioid antinociception in inflammation: Involvement of cytokines. *Eur. J. Pharmacol.* **242**, 299–235.
- Dahan, A., Yassen, A., Bijl, H., Romberg, R., Sarton, E., Teppema, L., Olofsen, E., and Danhof, M. (2005). Comparison of the respiratory effects of intravenous buprenorphine and fentanyl in humans and rats. *Br. J. Anaesth.* **94**, 825–834.
- Danbury, T.C., Weeks, C.A., Chambers, J.P., Waterman-Pearson, A.E., and Kestin, S.C. (2000). Self-selection of the analgesic drug carprofen by lame broiler chickens. *Vet. Rec.* **146**, 307–311.
- Dascombe, M.J. (1985). The pharmacology of fever. *Prog. Neurobiol.* **25**, 327–373.
- Davies, N.M., Wright, M.R., Russell, A.S., and Jamali, F. (1996). Effect of the enantiomers of flurbiprofen, ibuprofen, and ketoprofen on intestinal permeability. *J. Pharm. Sci.* **85**, 1170–1173.
- Davis, L.E. (1983). Species differences in drug disposition as factors in alleviation of pain. In "Animal Pain: Perception and Alleviation."

- (R.L. Kitchell and H.H. Erickson, eds.), pp 161–178. American Physical Society, Bethesda, MD.
- Davis, L.E., and Westfall, B.A. (1972). Species differences in the biotransformation excretion of salicylate. *Am. J. Vet. Res.* **33**, 1253–1262.
- Delatour, P., Foot, R., Foster, A.P., Baggot, D., and Lees, P. (1996). Pharmacodynamics and chiral pharmacokinetics of carprofen in calves. *Br. Vet. J.* **152**, 183–198.
- Diaz-Reval, M.I., Ventura-Martinez, R., Deciga-Campos, M., Terron, J.A., Cabre, F., and Lopez-Munoz, F.J. (2004). Evidence for a central mechanism of action of S-(+)-ketoprofen. *Eur. J. Pharmacol.* **483**, 241–248.
- Difilippo, S.M., Norberg, P.J., Suson, U.D., Savino, A.M., and Reim, D.A. (2004). A comparison of xylazine and medetomidine in an anesthetic combination in New Zealand white rabbits. *Contemp. Top. Lab. Anim. Sci.* **43**(1), 32–34.
- Dobbins, S., Brown, N.O., and Shofer, F.S. (2002). Comparison of the effects of buprenorphine, oxymorphone hydrochloride, and ketoprofen for postoperative analgesia after onychectomy or onychectomy and sterilization in cats. *J. Am. Anim. Hosp. Assoc.* **38**, 507–514.
- Dum, J.E., and Herz, A. (1981). In vivo receptor binding of the opiate partial agonist buprenorphine, correlated with its agonistic and antagonistic actions. *Br. J. Pharmacol.* **74**, 627–633.
- Egger, C.M., Duke, T., Archer, J., and Cribb, P.H. (1998). Comparison of plasma fentanyl concentrations by using three transdermal fentanyl patch sizes in dogs. *Vet. Surg.* **27**, 159–166.
- Eisenach, J.D. (1993). Overview: First international symposium on α_2 -adrenergic mechanisms of spinal anesthesia. *Reg. Anesth.* **18**, i–vi.
- Elmas, M., Yazar, E., Uney, K., and Karabacak, A. (2006). Pharmacokinetics of flunixin after intravenous administration in healthy and endotoxaemic rabbits. *Vet. Res. Commun.* **30**, 73–81.
- Flecknell, P.A. (1991). Post-operative analgesia in rabbits and rodents. *Lab. Anim.* **20**, 34–37.
- Forsyth, S.F., Guilford, W.G., and Pfeiffer, D.U. (2000). Effect of NSAID administration on creatinine clearance in healthy dogs undergoing anaesthesia and surgery. *J. Small Anim. Pract.* **41**, 547–550.
- Fuchs, B.A., and Pruett, S.B. (1993). Morphine induces apoptosis in murine thymocytes in vivo but not in vitro: Involvement of both opiate and glucocorticoid receptors. *J. Pharmacol. Exp. Ther.* **266**, 417–423.
- Gades, N.M., Danneman, P.J., Wixson, S.K., and Tolley, E.A. (2000). The magnitude and duration of the analgesic effect of morphine, butorphanol, and buprenorphine in rats and mice. *Contemp. Top. Lab. Anim. Sci.* **39**(2), 8–13.
- Garrett, E.R., and Chandran, V.R. (1985). Pharmacokinetics of morphine and its surrogates VI: Bioanalysis, solvolysis kinetics, solubility, pK_a values, and protein binding of buprenorphine. *J. Pharm. Sci.* **74**, 515–524.
- Garrido, M.J., Sayar, O., Segura, C., Rapado, J., Dios-Vieitez, M.C., Renedo, M.J., and Troconiz, I.F. (2003). Pharmacokinetic/pharmacodynamic modeling of the antinociceptive effects of (+)-tramadol in the rat: Role of cytochrome P450 2D activity. *J. Pharmacol. Exp. Ther.* **305**, 710–718.
- Gilberto, D.B., Motzel, S.L., and Das, S.R. (2003). Postoperative pain management using fentanyl patches in dogs. *Contemp. Top. Lab. Anim. Sci.* **42**(4), 21–36.
- Gillingham, M.B., Clark, M.D., Dahly, E.M., Krugner-Higby, L.A., and Ney, D.M. (2001). A comparison of two opioid analgesics for relief of visceral pain induced by intestinal resection in rats. *Contemp. Top. Lab. Anim. Sci.* **40**(1), 21–26.
- Graf, P., Glatt, M., and Brune, K. (1975). Acidic nonsteroidal anti-inflammatory drugs accumulating in inflamed tissue. *Experientia* **31**, 951–954.
- Graham, J.E., Kollias-Baker, C., Craigmill, A.L., Thomasy, S.M., and Tell, L.A. (2005). Pharmacokinetics of ketoprofen in Japanese Quail (*Coturnix japonica*). *J. Vet. Pharmacol. Ther.* **28**, 399–402.
- Gutstein, H.B. and Akil, H. (2001). Opioid analgesics. In “Goodman & Gilman’s The Pharmacological Basis of Therapeutics”. (J.G. Hardman and L.E. Limbird, eds.), 10th ed., pp. 569–619. McGraw-Hill, New York.
- Hall, L.W., and Clarke, K.W. (1991). Principles of sedation. In “Veterinary Anaesthesia.” 9th ed., p 58. Baillière Tindall, London.
- Hardie, E.M., Hardee, G. E., and Rawlings, C.A. (1985). Pharmacokinetics of flunixin meglumine in dogs. *Am. J. Vet. Res.* **46**, 235–237.
- Heel, R.C., Brogden, R.N., Speight, T.M., and Avery, G.S. (1977). Buprenorphine: A review of its pharmacological properties and therapeutic efficacy. *Drugs.* **17**, 81–110.
- Hickford, F.H., Barr, S.C., and Erb, H.N. (2001). Effect of carprofen on hemostatic variables in dogs. *Am. J. Vet. Res.* **62**, 1642–1646.
- Horii, Y., Ikenaga, M., Shimoda, M., and Kokue, E. (2004). Pharmacokinetics of flunixin in the cat: Enterohepatic circulation and active transport mechanism in the liver. *J. Vet. Pharmacol. Ther.* **27**, 65–69.
- Hosgood, G. (1990). Pharmacologic features of butorphanol in dogs and cats. *J. Am. Vet. Med. Assoc.* **196**, 135–136.
- Hsu, W.H., Lee, P., and Betts, D.M. (1981). Xylazine-induced mydriasis in rats and its antagonism by alpha-adrenergic blocking agents. *J. Vet. Pharmacol. Ther.* **4**, 97–101.
- Hsu, W.S. (1981). Xylazine-induced depression and its antagonism by α_2 -adrenergic blocking agents. *J. Pharmacol. Exp. Ther.* **218**, 188.
- Hug, C.C., Jr., and Murphy, M.R. (1981). Tissue redistribution of fentanyl and termination of its effects in rats. *Anesthesiology* **55**, 369–375.
- Hughes, H.C., and Lang, C.M. (1983). Control of pain in dogs and cats. In “Animal Pain: Perception and Alleviation.” (R.L. Kitchell and H.H. Erickson, eds.), pp 207–216. American Physiological Society, Bethesda, MD.
- Hunter, R.P., Isaza, R., Carpenter, J.W., and Koch, D.E. (2004). Clinical effects and plasma concentrations of fentanyl after transmucosal administration in three species of great ape. *J. Zoo Wildl. Med.* **35**, 162–166.
- Hussain, M.A., and Augst, B.J. (1997). Intranasal absorption of oxymorphone. *J. Pharm. Sci.* **86**, 975–976.
- Hutchings, D.E., Zmitrovich, C., Hamowy, A.S., and Liu, P.R. (1995). Prenatal administration of buprenorphine using the osmotic minipump: A preliminary study of maternal and offspring toxicity and growth in the rat. *Neurotoxicol. Teratol.* **17**, 419–423.
- Igarza, L., Soraci, A., Auza, N., and Zeballos, H. (2004). Some pharmacokinetic parameters of R(-) and S-(+)-ketoprofen: The influence of age and differing physiological status in dairy cattle. *Vet. Res. Com.* **28**, 81–87.
- Insel, P.A. (1990). Analgesic-antipyretics and antiinflammatory agents: Drugs employed in the treatment of rheumatoid arthritis and gout. In “The Pharmacological Basis of Therapeutics.” (A.G. Gilman, T.W. Rall, A.S. Nies, and P. Taylor, eds.), 8th ed., pp 638–681. Pergamon, New York.
- Irazusta, J.E., Ahmed, U., Gancayco, A., Ahmed, S.T., Zhang, J., and Anand, K.J. (1996). Intratracheal administration of fentanyl: Pharmacokinetics and local tissue effects. *Intensive Care Med.* **22**, 129–133.
- Itamoto, K., Taura, Y., Wada, N., Taga, A., Takuma, T., Matsumura, H., and Miyara, T. (2001). Effect of medetomidine on electroencephalography and use of a quantitative electroencephalograph for evaluating sedation levels in dogs. *J. Vet. Med. Ser. A.* **48**, 525–535.
- Iwakawa, S., Spahn, H., Benet, L.Z., and Lin, E.T. (1991). Stereoselective disposition of carprofen, flunoxaprofen, and naproxen in rats. *Drug Metab. Disp.* **19**, 853–857.
- Jablonski, P., Howden, B.O., and Baxter, K. (2000). Influence of buprenorphine analgesia on post-operative recovery in two strains of rats. *Lab. Anim.* **35**, 213–222.
- Jaffe, J.H., and Martin, W.R. (1990). Opioid analgesics and antagonists. In “The Pharmacological Basis of Therapeutics.” (A.G. Gilman, T.W. Rall, A.S. Nies, and P. Taylor, eds.), 8th ed., pp 485–521. Pergamon, New York.
- Joy, R.M., Stark, L.G., and Albertson, T.E. (1983). Dose-dependent proconvulsant and anticonvulsant actions of the alpha 2 adrenergic agonist, xylazine, on kindled seizures in the rat. *Pharmacol. Biochem. Behav.* **19**, 345–350.
- Kastner, S.B.R., Pakarinen, S.M., Ramela, M.P., Kutter, A.P.N., Boller, J., and Huhtinen, M.K. (2006). Comparative pharmacokinetics of medetomidine enantiomers in goats and sheep during sevoflurane anaesthesia. *J. Vet. Pharmacol. Ther.* **29**, 63–66.
- Kastner, S.B.R., Wapf, P., Feige, K., Demuth, D., Bettschart-Wolfensberger, R., Akens, M.K., and Huhtinen, M. (2003). Pharmacokinetics and sedative

- effects of intramuscular medetomidine in domestic sheep. *J. Vet. Pharmacol. Ther.* **26**, 271–276.
- Kirchner, T., Aparico, B., Argentieri, D.C., Lau, C.Y., and Ritchie, D.M. (1997). Effects of tepoxalin, a dual inhibitor of cyclooxygenase/5-lipoxygenase, on events associated with NSAID-induced gastrointestinal inflammation. *Prostaglandins Leukot. Essent. Fatty Acids* **56**, 417–423.
- Kis, B., Snipes, J.A., and Busija, D.W. (2005). Acetaminophen and the cyclooxygenase-3 puzzle: Sorting out facts, fictions, and uncertainties. *J. Pharmacol. Exp. Ther.* **315**, 1–7.
- Konigsson, K., Torneke, K., Engeland, I.V., Odensvik, K., and Kindahl, H. (2003). Pharmacokinetics and pharmacodynamic effects of flunixin after intravenous, intramuscular and oral administration to dairy goats. *Acta Vet. Scand.* **44**, 153–159.
- Kostopanagiotou, G., Markantonis, S.L., Arkadopoulos, N., Andreadou, I., Charalambidis, G., Chondroudaki, J., Costopanagiotou, C., and Smyrniotis, V. (2006). The effect of acutely induced hepatic failure on remifentanyl and fentanyl blood levels in a pig model. *Eur. J. Anaesthesiol.* **23**, 598–604.
- Kroin, J.S., Buvanendran, A., Watts, D.E., Saha, C., and Tuman, K.J. (2006). Upregulation of cerebrospinal fluid and peripheral prostaglandin E₂ in a rat postoperative pain model. *Anesth. Pharmacol.* **103**, 334–343.
- Krugner-Higby, L., Smith, L., Clark, M., Heath, T.D., Dahly, E., Schiffman, B., Hubbard-VanStelle, S., Ney, D., and Wendland, A. (2003). Liposome-encapsulated oxymorphone hydrochloride provides prolonged relief of postsurgical visceral pain in rats. *Comp. Med.* **53**, 270–279.
- Kucuk, A., Kadioglu, Y., and Celebi, F. (2005). Investigation of the pharmacokinetics and determination of tramadol in rabbit plasma by a high-performance liquid chromatography-diode array detector method using liquid-liquid extraction. *J. Chromatogr. B. Analyt. Technol. Biomed. Life. Sci.* **816**, 203–208.
- KuKanich, B., and Papich, M.G. (2004). Pharmacokinetics of tramadol and the metabolite *O*-desmethyltramadol in dogs. *J. Vet. Pharmacol. Ther.* **27**, 239–246.
- Lamont, L.A., Bulmer, B.J., Grimm, K.A., Tranquilli, W.J., and Sisson, D.D. (2001). Cardiopulmonary evaluation of the use of medetomidine hydrochloride in cats. *Am. J. Vet. Res.* **62**, 1745–1749.
- Landoni, M.F., Cunningham, F.M., and Lees, P. (1995). Pharmacokinetics and pharmacodynamics of ketoprofen in calves applying PK/PD modeling. *J. Vet. Pharmacol. Ther.* **18**, 315–324.
- Laredo, F.G., Belda, E., Murciano, J., Escobar, M., Navarro, A., Robinson, K.J., and Jones, R.S. (2004). Comparison of the analgesic effects of meloxicam and carprofen administered preoperatively to dogs undergoing orthopaedic surgery. *Vet. Rec.* **155**, 667–671.
- Lascalles, B.D., and Robertson, S.A. (2004). Antinociceptive effects of hydromorphone, butorphanol, or the combination in cats. *J. Vet. Intern. Med.* **18**, 190–195.
- Lee, D.D., Papich, M.G., and Hardie, E.M. (2000). Comparison of pharmacokinetics of fentanyl after intravenous and transdermal administration in cats. *Am. J. Vet. Res.* **61**, 672–677.
- Lees, P., Aliabadi, F.S., and Landoni, M.F. (2002). Pharmacodynamics and enantioselective pharmacokinetics of carprofen in the horse. *J. Vet. Pharmacol. Ther.* **25**, 443–448.
- Lees, P., Taylor, P.M., Landoni, F.M., Arifah, A.K., and Waters, C. (2003). Ketoprofen in the cat: Pharmacodynamics and chiral pharmacokinetics. *Vet. J.* **161**, 21–35.
- Lemke, K.A. (2004). Perioperative use of selective alpha-2 agonists and antagonists in small animals. *Can. Vet. J.* **45**, 475–480.
- Levier, D.G., Brown, R.D., McCay, J.A., Fuchs, B.A., Harris, L.S., and Munson, A.E. (1993). Hepatic and splenic phagocytosis in female B6C3F1 mice implanted with morphine sulfate pellets. *J. Pharmacol. Exp. Ther.* **267**, 357–363.
- Levoine, N., Blondeau, C., Guillaume, C., Grandcolas, L., Chretien, F., Jouzeau, J.Y., Benoit, E., Chapleur, Y., Netter, P., and Lapique, F. (2004). Elucidation of the mechanism of inhibition of cyclooxygenases by acyl-coenzyme A and acylglucuronic conjugates of ketoprofen. *Biochem. Pharmacol.* **68**, 1957–1969.
- Liles, J.H., and Flecknell, P.A. (1992). The effects of buprenorphine, nalbuphine and butorphanol alone or following halothane anesthesia on food and water consumption and locomotor movement in rats. *Lab. Anim.* **26**, 180–189.
- Lobetti, R.G., and Joubert, K.E. (2000). Effect of administration of nonsteroidal anti-inflammatory drugs before surgery on renal function in clinically normal dogs. *Am. J. Vet. Res.* **61**, 1501–1507.
- Lohuis, J.A., van Werven, T., Brand, A., van Miert, A.S., Rohde, E., Ludwig, B., Heizmann, P., and Rehm, W.F. (1991). Pharmacodynamics and pharmacokinetics of carprofen, a non-steroidal anti-inflammatory drug, in healthy cows and cows with *Escherichia coli* endotoxin-induced mastitis. *J. Vet. Pharmacol. Ther.* **14**, 219–229.
- Ludwig, B., Jordan, J.C., Rehm, W.F., and Thun, R. (1989). Carprofen in veterinary medicine. I. Plasma disposition, milk excretion and tolerance in milk-producing cows. *Schweiz. Arch. Tierheilkd.* **131**, 99–106.
- MacDonald, E., and Virtanen, R. (1992a). Review of the pharmacology of medetomidine and detomidine: Two chemically similar α_2 -adrenoceptor agonists used as veterinary sedatives. In “Animal Pain.” (C.E. Short and A. Van Poznan, eds.), pp 181–191. Churchill-Livingstone, New York.
- MacDonald, E. and Virtanen, R. (1992b). The effects of buprenorphine, nalbuphine and butorphanol alone or following halothane anesthesia on food and water consumption and locomotor movement in rats. *Lab. Anim.* **26**, 180–189.
- Machado, C.E., Dyson, D.H., and Grant Maxie, M. (2006). Effects of oxymorphone and hydromorphone on the minimum alveolar concentration of isoflurane in dogs. *Vet. Anaesth. Analg.* **33**, 70–77.
- Machin, K.L., Tellier, L.A., Lair, S., and Livingston, A. (2001). Pharmacodynamics of flunixin and ketoprofen in mallard ducks (*Anas platyrhynchos*). *J. Zoo Wildl. Med.* **32**, 222–229.
- Maire-Gauthier, R., Burofossé, T., Magdalou, J., Herber, R., Besse, S., Delatour, P., and Benoit, E. (1998). Species-dependent enantioselective glucuronidation of carprofen. *Xenobiotica* **28**, 595–604.
- Malmberg, A.B., and Yaksh, T.L. (1993). Pharmacology of the spinal action of ketorolac, morphine, ST-91, U50488H, and LPIA on the formalin test and an isobolographic analysis of the NSAID interaction. *Anesthesiology* **79**, 270–281.
- Mathews, K.A., Paley, D.M., Foster, R.A., Valliant, A.E., and Young, S.S. (1996). A comparison of ketorolac with flunixin, butorphanol, and oxymorphone in controlling postoperative pain in dogs. *Can. Vet. J.* **37**, 557–567.
- Mauleon, D., Mis, R., Ginesta, J., Ortega, E., Vilageliu, J., Basi, N., and Carganico, G. (1994). Pharmacokinetics of ketoprofen enantiomers in monkeys following single and multiple oral administration. *Chirality* **6**, 537–542.
- Maxwell, L.K., Thomasy, S.M., Slovis, N., and Kollias-Baker, C. (2003). Pharmacokinetics of fentanyl following intravenous and transdermal administration in horses. *Equine Vet. J.* **35**, 484–490.
- McClain, R.M., and Hoar, R.M. (1980). Reproduction studies with carprofen, a nonsteroidal anti-inflammatory agent in rats. *Toxicol. Appl. Pharmacol.* **56**, 376–382.
- Merskey, H., and Bogduk, N. (eds.). (1994). “Classification of Chronic Pain,” 2nd ed., p 210. IASP Press, Seattle, WA.
- Meunier, C.J., and Verbeeck, R.K. (1999). Glucuronidation kinetics of R, S-ketoprofen in adjuvant-induced arthritic rats. *Pharm. Res.* **16**, 1081–1086.
- Mickley, G.A., Hoxha, Z., Biada, J.M., Kenmuir, C.L., and Bacik, S.E. (2006). Acetaminophen self-administered in the drinking water increases the pain threshold of rats (*Rattus norvegicus*). *J. Am. Assoc. Lab. Anim. Sci.* **45**, 48–54.
- Molina, C., and Herrero, J.F. (2006). The influence of the time course of inflammation and spinalization on the antinociceptive activity of the α_2 -adrenoceptor agonist medetomidine. *Eur. J. Pharmacol.* **532**, 50–60.
- Montoya, L., Ambros, L., Kreil, V., Bonafine, R., Albarellos, G., Hallu, R., and Soraci, A. (2004). A pharmacokinetic comparison of meloxicam and ketoprofen following oral administration to healthy dogs. *Vet. Res. Commun.* **28**, 415–428.

- Novick, D.M., Ochshorn, M., Ghali, V., Croxson, T.S., Mercer, W.D., Chiorazzi, N., and Kreek, M.J. (1989). Natural killer cell activity and lymphocyte subsets in parenteral heroin abusers and long-term methadone maintenance patients. *J. Pharmacol. Exp. Ther.* **250**, 606–610.
- Ogino, T., Mizuno, Y., Ogata, T., and Takahashi, Y. (2005). Pharmacokinetic interactions of flunixin meglumine and enrofloxacin in dogs. *Am. J. Vet. Res.* **66**, 1209–1213.
- Ogiso, T., Kitagawa, T., Iwaki, M., and Tanino, T. (1997). Pharmacokinetic analysis of enterohepatic circulation of etodolac and effect of hepatic and renal injury on the pharmacokinetics. *Biol. Pharm. Bull.* **20**, 405–410.
- Ohtani, M., Kotaki, H., Uchino, K., Sawada, Y., and Iga, T. (1994). Pharmacokinetic analysis of enterohepatic circulation of buprenorphine and its active metabolite, norbuprenorphine, in rats. *Drug Metab. Dispos.* **22**, 2–7.
- Ota, S., Bamba, H., Kato, A., Kawamoto, C., Yoshida, Y., and Fujiwara, K. (2002). Review article: COX-2, prostanooids and colon cancer. *Aliment. Pharmacol. Ther.* **16**(Suppl. 2), 102–106.
- Palylyk-Colwell, E.L., and Jamali, F. (2004). Effect of gonadectomy and hormones on sex differences in ketoprofen enantiomer glucuronidation and renal excretion of formed glucuronides in the rat. *Pharm. Res.* **21**, 989–995.
- Peckham, E.M., and Traynor, J.R. (2006). Comparison of the antinociceptive response to morphine and morphine-like compounds in male and female Sprague-Dawley rats. *J. Pharmacol. Exp. Ther.* **316**, 1195–1201.
- Pibarot, P., Dupuis, J., Grisneaux, E., Cuvelliez, S., Plante, J., Beaugard, G., Bonneau, N.H., Bouffard, J., and Blais, D. (1997). Comparison of ketoprofen, oxymorphone hydrochloride, and butorphanol in the treatment of postoperative pain in dogs. *J. Am. Vet. Med. Assoc.* **211**, 438–444.
- Pinardi, G., Sierralta, F., and Miranda, H.F. (2001). Interaction between the antinociceptive effect of ketoprofen and adrenergic modulatory systems. *Inflammation* **25**, 233–239.
- Portnoy, L.G., and Hustead, D.R. (1992). Pharmacokinetics of butorphanol tartrate in rabbits. *Am. J. Vet. Res.* **53**, 541–543.
- Power, I. (2005). Recent advances in postoperative pain therapy. *Br. J. Anaesth.* **95**, 43–51.
- Pruett, S.B., Han, Y.C., and Fuchs, B.A. (1992). Morphine suppresses primary humoral immune responses by a predominately indirect mechanism. *J. Pharmacol. Exp. Ther.* **262**, 923–928.
- Quimby, F.W. (1991). Pain in animals and humans: An introduction. *ILAR News* **33**, 2–3.
- Roberts, L.J., and Morrow, J.D. (2001). Analgesic-antipyretic and antiinflammatory agents and drugs employed in the treatment of gout. In “Goodman & Gilman’s The Pharmacological Basis of Therapeutics.” (J.G. Hardman and L.E. Limbird, eds.), 10th ed., pp 687–731. McGraw-Hill, New York.
- Robertson, S.A., Taylor, P.M., Lascelles, B.D., and Dixon, M.J. (2003). Changes in thermal threshold response in eight cats after administration of buprenorphine, butorphanol and morphine. *Vet. Rec.* **153**, 462–465.
- Robertson, S.A., Taylor, P.M., Sear, J.W., and Keuhnel, G. (2005). Relationship between plasma concentrations and analgesia after intravenous fentanyl and disposition after other routes of administration in cats. *J. Vet. Pharmacol. Ther.* **28**, 87–93.
- Robinson, E.P., Faggella, A.M., Henry, D.P., and Russell, W.L. (1988). Comparison of histamine release induced by morphine and oxymorphone administration in dogs. *Am. J. Vet. Res.* **49**, 1699–1701.
- Roth, G.R., and Siok, C.J. (1978). Acetylation of the NH₂-terminal serine of prostaglandin synthetase by aspirin. *J. Biol. Chem.* **253**, 3782–3784.
- Roughan, J.V., and Flecknell, P.A. (2002). Buprenorphine: A reappraisal of its antinociceptive effects and therapeutic use in alleviating post-operative pain in animals. *Lab. Anim.* **36**, 322–343.
- Roughan, J.V., and Flecknell, P.A. (2004). Behaviour-based assessment of the duration of laparotomy-induced abdominal pain and the analgesic effects of carprofen and buprenorphine in rats. *Behav. Pharmacol.* **15**, 461–472.
- Sano, T., Nishimura, R., Kanazawa, H., Igarashi, E., Nagata, Y., Mochizuki, M., and Sasaki, N. (2006). Pharmacokinetics of fentanyl after single intravenous injection and constant rate infusion in dogs. *Vet. Anaesth. Analg.* **33**, 266–273.
- Saper, C.B., and Breder, C.D. (1994). The neurologic basis of fever. *N. Engl. J. Med.* **330**, 1880–1886.
- Satterwhite, J.H., and Boudinot, F.D. (1992). Pharmacokinetics of ketoprofen in rats: Effect of age and dose. *Biopharm. Drug Dispos.* **13**, 197–212.
- Savola, J.M., Ruskoaho, H., Puurunen, J., Salonen, J.S., and Kärki, N.T. (1986). Evidence for medetomidine as a selective and potent agonist of α_2 -adrenoceptors. *J. Auton. Pharmacol.* **5**, 275–284.
- Schmitt, M., and Gentert, T.W. (1990a). Biopharmaceutical evaluation of carprofen following intravenous, oral, and rectal administration in dogs. *Biopharm. Drug Dispos.* **11**, 585–594.
- Schmitt, M., and Gentert, T.W. (1990b). Biopharmaceutical evaluation of ketoprofen following intravenous, oral, and rectal administration in dogs. *J. Pharm. Sci.* **79**, 614–616.
- Schoemaker, N.J., Mol, J.A., Lumeij, J.T., Thijssen, J.H.H., and Rijnberk, A. (2003). Effects of anaesthesia and manual restraint on the plasma concentrations of pituitary and adrenocortical hormones in ferrets. *Vet. Rec.* **152**, 591–595.
- Shannon, H. (2007). Personal communication.
- Sharp, J., Zammit, T., Azar, T., and Lawson, D. (2003). Recovery of male rats from major abdominal surgery after treatment with various analgesics. *Contemp. Top. Lab. Anim. Sci.* **42**(6), 22–27.
- Shavit, Y., Lewis, J.W., Terman, G.W., Gale, R.P., and Liebeskind, J.C. (1984). Opioid peptides mediate the suppressive effect of stress on natural killer cell cytolytic activity. *Science* **223**, 188–190.
- Shi, J.M., Lai, S.G., Xu, C.J., Duan, G.L., and Li, D. (2004). Pharmacokinetic difference between S-(+) and R-(–)-etodolac in rats. *Acta Pharmacol. Sin.* **25**, 996–999.
- Sinclair, M.D. (2003). A review of the physiological effects of alpha2-agonists related to the clinical use of medetomidine in small animal practice. *Can. Vet. J.* **44**, 885–897.
- Sladky, K.K., Krugner-Higby, L., Meek-Walker, E., Heath, T.D., and Paul-Murphy, J. (2006). Serum concentrations and analgesic effects of liposome-encapsulated and standard butorphanol tartrate in parrots. *Am. J. Vet. Res.* **67**, 775–781.
- Smith, L.J., Krugner-Higby, L., Clark, M., Wendland, A., and Heath, T.D. (2003). A single dose of liposome-encapsulated oxymorphone or morphine provides long-term analgesia in an animal model of neuropathic pain. *Comp. Med.* **53**, 280–287.
- Smith, L.J., Krugner-Higby, L., Trepanier, L.A., Flaska, D.E., Joers, V., and Heath, T.D. (2004). Sedative effects and serum drug concentrations of oxymorphone and metabolites after subcutaneous administration of a liposome-encapsulated formulation in dogs. *J. Vet. Pharmacol. Ther.* **27**, 369–372.
- Smith, R.J. (1978). Nonsteroid anti-inflammatory agents: Regulators of the phagocytic secretion of lysosomal enzymes from guinea-pig neutrophils. *J. Pharmacol. Exp. Ther.* **207**, 618–629.
- Snipes, J.A., Kis, B., Shelness, G.S., Hewett, J.A., and Busija, D.W. (2005). Cloning and characterization of cyclooxygenase-1b (putative cyclooxygenase-3) in rat. *J. Pharmacol. Exp. Ther.* **313**, 668–676.
- Speth, R.C., Smith, M.S., and Brogan, R.S. (2001). Regarding the inadvisability of administering postoperative analgesics in the drinking water of rats (*Rattus norvegicus*). *Contemp. Top. Lab. Anim. Sci.* **40**(6), 15–17.
- Stewart, L.S.A., and Martin, W.J. (2003). Evaluation of postoperative analgesia in a rat model of incisional pain. *Contemp. Top. Lab. Anim. Sci.* **42**(1), 28–34.
- Streppa, H.K., Jones, C.J., and Budsberg, S.C. (2002). Cyclooxygenase selectivity of nonsteroidal anti-inflammatory drugs in canine blood. *Am. J. Vet. Res.* **63**, 91–94.
- Strigo, I.A., Duncan, G.H., Bushnell, M.C., et al. (2005). The effects of racemic ketamine on painful stimulation of skin and viscera in human subjects. *Pain* **113**, 255–264.
- Suyama, H., Kawamoto, M., Gaus, S., and Yuge, O. (2004). Effect of etodolac, a COX-2 inhibitor, on neuropathic pain in a rat model. *Brain Res.* **4**, 144–150.
- Szabo, I., Rojivin, M., Bussiere, J.L., Eisenstein, T.K., Adler, M.W., and Rogers, T.S. (1993). Suppression of peritoneal macrophage phagocytosis of *Candida albicans* by opioids. *J. Pharmacol. Exp. Ther.* **267**, 703–706.

- Tachibana, M., Inoue, N., Yoshida, E., Matsui, M., Ukai, Y., and Yano, J. (2003). Anti-inflammatory effect and low ulcerogenic activity of etodolac, a cyclooxygenase-2 selective non-steroidal anti-inflammatory drug, on adjuvant-induced arthritis in rats. *Pharmacology* **68**, 96–104.
- Taylor, P.M., Delatour, P., Landoni, F.M., Deal, C., Pickett, C., Shojaee, F., Aliabadi, R., Foot, R., and Lees, P. (1996). Pharmacodynamics and enantioselective pharmacokinetics of carprofen in the cat. *Res. Vet. Sci.* **60**, 144–151.
- Taylor, P.M., Robertson, S.A., Dixon, M.J., Ruprah, M., Sear, J.W., Lascelles, B.D., Waters, C., and Bloomfield, M. (2001). Morphine, pethidine and buprenorphine disposition in the cat. *J. Vet. Pharmacol. Ther.* **24**, 391–398.
- Turner, J.M., Lomas, L.M., Smith, E.S., Barrett, A.C., and Picker, M.J. (2003). Pharmacogenetic analysis of sex differences in opioid antinociception in rats. *Pain* **106**, 381–391.
- Väisänen, M.A.M., Vainio, O.M., Raekallio, M.R., Hietanen, H., and Huikuri, H.V. (2005). Results of 24-hour ambulatory electrocardiography in dogs undergoing ovariohysterectomy following premedication with medetomidine or acepromazine. *J. Am. Vet. Med. Assoc.* **226**, 738–745.
- Valverde, C.R., Mama, K.R., Kollias-Baker, C., Steffey, E.P., and Baggot, J.D. (2000). Pharmacokinetics and cardiopulmonary effects of fentanyl in isoflurane-anesthetized rhesus monkeys (*Macaca mulatta*). *Am. J. Vet. Res.* **61**, 931–934.
- Vonderhaar, M.A., and Salisbury, S.K. (1993). Gastroduodenal ulceration associated with flunixin meglumine administration in three dogs. *J. Am. Vet. Med. Assoc.* **203**, 92–95.
- Warner, T.D., Giuliano, F., Vojnovic, I., Bukasa, A., Mitchell, J.A., and Vane, J.R. (1999). Nonsteroidal drug selectivities for cyclo-oxygenase-1 rather than cyclo-oxygenase-2 are associated with human gastrointestinal toxicity: A full in vitro analysis. *Proc. Natl. Acad. Sci. U.S.A.* **96**, 7563–7568.
- Warner, T.D., and Mitchell, J.A. (2004). Cyclooxygenases: New forms, new inhibitors, and lessons from the clinic. *FASEB J.* **18**, 790–804.
- Welsh, E.M., Baxter, P., and Nolan, A.M. (1992). Pharmacokinetics of carprofen administered intravenously to sheep. *Res. Vet. Sci.* **53**, 264–266.
- Wilson, D., Pettifer, G.R., and Hosgood, G. (2006). Effect of transdermally administered fentanyl on minimum alveolar concentration of isoflurane in normothermic and hypothermic dogs. *J. Am. Vet. Med. Assoc.* **228**, 1042–1046.
- Woolf, C.J., Bennett, G.J., Doherty, M., et al. (1998). Towards a mechanism-based classification of pain? *Pain* **77**, 227–229.
- Yamashita, K., Tsubakishita, S., Futaok, S., Ueda, I., Hamaguchi, H., Seno, T., Katoh, S., Izumisawa, Y., Kotani, T., and Muir, W.W. (2000). Cardiovascular effects of medetomidine, detomidine and xylazine in horses. *J. Vet. Med. Sci.* **62**, 1025–1032.
- Yasui, H., Yamaoka, K., and Nakagawa, T. (1996). Moment analysis of stereoselective enterohepatic circulation and unidirectional chiral inversion of ketoprofen enantiomers in rat. *J. Pharm. Sci.* **85**, 580–585.
- Yu, S., Zhang, X., Sun, Y., Peng, Y., Johnson, J., Mandrell, T., Shukla, A.J., and Laizure, S.C. (2006). Pharmacokinetics of buprenorphine after intravenous administration in the mouse. *J. Am. Assoc. Lab. Anim. Sci.* **45**(3), 12–16.

This page intentionally left blank

Section II

Monitoring and Equipment

This page intentionally left blank

Anesthesia Delivery Systems

George A. Vogler

I. Introduction	128
II. Compressed Gases	128
A. Cylinders	128
B. Medical Gas Piping Systems	130
III. Anesthetic Machine Components	130
A. Introduction	130
B. Yoke Assemblies	131
C. Central Supply Connections	131
D. Pressure Regulation	131
E. Gas Supply Pressure Gauges	132
F. Flowmeters	132
G. Oxygen Fail-Safe and Proportioning Systems	134
H. Oxygen Flush Valve	134
I. Common Gas Outlet	134
J. Absorber Systems	134
K. Unidirectional Valves	135
L. Adjustable Pressure-Limiting Valve	135
M. Reservoir Bag	135
N. Breathing System Manometer	136
O. Vaporizers	136
P. Scavenging Systems	140
IV. Breathing Circuits	141
A. Introduction	141
B. Dead Space	142
C. Materials	142
D. Classification	142
E. Rebreathing Systems	142
F. Nonrebreathing Systems	143
V. Anesthetic Machines	145
A. Introduction	145
B. Rodent Anesthesia Machines	146
C. Veterinary Machines	147
D. Human Anesthesia Machines and Workstations	148

E. Used Anesthesia Machines	150
F. Maintenance and Testing	150
VI. Ventilators	151
A. Introduction	151
B. Bellows Ventilators	152
C. Piston Ventilators	154
D. Pneumatic Ventilators	154
E. Jet Ventilation and High-Frequency Ventilation	155
VII. Induction Chambers and Masks	155
A. Induction Chambers	155
B. Face Masks	156
VIII. Injectable Anesthetic Delivery Systems	158
IX. Equipment for Airway Access and Control	159
A. Laryngoscopes	159
B. Endotracheal Tubes	162
C. Stylets, Guides, and Tube Exchangers	166
Additional Reading	167
References	167

I. INTRODUCTION

With careful drug and dose selection, anesthesia can be obtained using virtually any route of administration. To gain responsive and consistent control of onset, depth, and duration of general anesthesia, however, inhalational or intravenous methods are usually selected. The delivery equipment associated with these two techniques is the subject of this chapter.

Since the first edition of this text, the needs of researchers and clinicians working with small laboratory rodents have been addressed with specially designed and often innovative anesthesia machines. Concurrently, improvements have been made in small and large animal clinical veterinary anesthesia machines. Machines made for human clinical anesthesia have continued further down the path of increasing complexity: larger units, with integrated ventilators, extensive use of microprocessors for controls and alarms, and in many cases, integrated physiological and safety monitors are now the rule.

The equipment and methods used for patient monitoring and for waste gas monitoring have assumed increasing importance and are described in Chapters 7 and 8.

II. COMPRESSED GASES

The compressed gases most commonly used in laboratory animal anesthesia are oxygen, nitrous oxide, and medical air. Despite not being a component of general anesthesia, carbon dioxide is often used for euthanasia of small rodents, and when mixed with oxygen is sometimes used for momentary restraint of rodents. It is also routinely used for insufflation during laparoscopic procedures. Cylinders of carbon dioxide are ubiquitous in most laboratory animal facilities. Nitrogen, at relatively high delivery pressures, is often used as the power source for pneumatically powered surgical instruments, and may well

be encountered in large or specialized surgical facilities. Less commonly, special mixtures of oxygen with carbon dioxide, nitrogen, nitrous oxide, or helium may be used for a variety of therapeutic or research purposes.

The manufacture of compressed gases, cylinders, and associated delivery equipment is regulated by governmental agencies. However, national compressed gas industrial associations, such as the Compressed Gas Association in the United States and Canada, and the European Industrial Gas Association cooperate closely with their respective national authorities to set manufacturing and safety standards. Medical gases are treated as drugs, and their composition, manufacture, and identification are further regulated by appropriate national entities. Gases and gas mixtures intended for industrial use may contain toxic contaminants and hence should not be used for medical purposes.

Even in facilities that have a central gas supply system, compressed gas cylinders are common in the operating room. Representative examples of medical gas cylinders are discussed below.

A. Cylinders

1. *E Tanks*

E cylinders are small tanks mounted on the anesthetic machine or attached to a separate regulator by means of a yoke assembly. The cylinder valve port forms a flush connection with the yoke, using the Pin Index Safety System, a safety standard intended to avoid misconnection. The yoke is fitted with two steel pins corresponding to holes in the cylinder valve assembly. The spacing of the yoke pins and tank holes is specific to a particular gas preventing the wrong gas from being connected to the yoke. Damaged missing pins defeat the safety system, and care should be taken to inspect the yoke each time a fresh cylinder is mounted to assure that the pins are intact and the yoke is in good condition. No attempt should be made to bypass this safety system (Petty and Sosis, 1997a).

A gasket is used to assure a gas-tight seal between the cylinder and the yoke. E cylinders are usually supplied with a fresh gasket fitted over the port and covered by a plastic seal. The gasket should be replaced each time a fresh tank is mounted. If both the cylinder port and the yoke are in good repair, only a single gasket is needed. Multiple gaskets should not be used in an attempt to seal a leaky connection. Instead, the yoke should be repaired if needed, or the cylinder labeled and returned to the supplier.

Special cylinder wrenches, or handles are made to fit small tank valves. A common design is a flat metal or plastic wrench with two slots at one end, arranged at 90° from each other to simplify engaging the valve stem. One style, seen in Fig. 5-1, also has a larger hexagonal slot at the opposite end, used for tightening the valve packing nut. Since this design serves equally well for loosening the packing nut, it is probably best avoided for safety reasons.

Small tank valves incorporate a pressure relief device opposite the outlet port and below the conical depression for the yoke retaining screw. The pressure relief device is designed to release

the tank contents at unsafe levels of pressure or temperature, or both.

2. Large Tanks

The nomenclature for these tanks varies with local custom and supplier. In Table 5-1, they are identified by the typical volume of gas held at normal service pressure, the maximum pressure to which they are normally filled. These tanks are used to supply small central piping systems, or to directly supply gas to an anesthetic machine, a common practice in laboratories. The valve assembly includes a hand wheel, so a wrench is not needed to open or close the valve. The threaded protective cap that covers the valve assembly during shipping should remain in place until the tank is in use. Tank valves are not pressure regulators. For safe use, a pressure regulator is necessary, either for individual tanks, or as part of a manifold supply system. Large tank outlet ports use specific styles and patterns of threaded connections to minimize the risk of unsafe connections with regulators or manifolds. As with small cylinders, a safety relief device is incorporated into the valve assembly.

3. Identification and Markings

Cylinders are identified by a series of numbers and symbols stamped into the metal near the neck. These markings specify the type and manufacturing standard for the cylinder, the maximum service pressure, the maker or owner, the serial number, and the test date and inspector's identification. If the cylinder has been in use for more than 10 years, the date of retesting also appears (Compressed Gas Association, Inc., 1996).

A label is used to indicate the cylinder contents. The user should ensure that the label clearly and legibly describes the contents, and provides information concerning the hazard classification. Cylinders with missing or defaced labels should be returned to the vendor, and should not be used. Medical gas cylinders are also color-coded. Table 5-1 lists the colors used in



Fig. 5-1 Small Tank Wrench. Notice the two slots for the tank valve and the larger hexagonal opening for the valve-packing nut.

TABLE 5-1
COMMON MEDICAL GAS CYLINDERS

Style dimensions (OD×H) (cm)	Pressure		Air (L)	Carbon dioxide (L)	Nitrogen (L)	Nitrous oxide (L)	Oxygen (L)
	At 15° C (in kPa)	At 70° F (psig)					
E (10.8×66)	13890	2015	650	1590	640	1590	1590
110* (17.8×109)	13890	2015	2970	7570	2920	7570	3160
200* (21.6×130)	13890	2015	5260	13800	5160	13800	5590
225* (23.5×130)	13890	2015	5900	15800	5800	15800	6270
250* (23.5×130)	15620	2265	6590	—	6460	—	7060
Color	USA		Yellow	Gray	Black	Blue	Green
	Canada		Black & White	Gray	Black	Blue	White
	European Union		Black & White	Gray	Black	Blue	White

Note: Approval for publication received from Compressed Gas Association. Nomenclature varies. Except for E tanks, the first number indicates typical volume in cubic feet at normal service pressure.

Source: Compressed Gas Association, Inc. (1996) and British Compressed Gases Association (2005).

the United States, Canada, and the European Union for single gases. Color combinations may be used to indicate gas mixtures, and are further described in the relevant publications (British Compressed Gas Association, 2005; Compressed Gas Association, Inc., 1996). Although color codes are helpful in identifying cylinder contents, the label should always be read to ensure the correct gas is being used.

4. *Safety Precautions*

Compressed gas cylinders are potentially hazardous; all those who handle, connect, or use cylinders should be aware of the danger and be trained in safe handling practices. Texts dealing exclusively with anesthesia equipment and publications of industry associations list several pages of warnings and precautions detailing the safe use of compressed gas cylinders and connections in anesthesia (Bland, 2005a; Dorsch and Dorsch, 1999a). Such detail is well beyond the scope of this chapter, but a few elements of safe practice are summarized below (Compressed Gas Association, Inc., 1996).

1. Cylinders should be stored in a manner that prevents exposure to extremes of temperature, weather, and chemicals or fumes that can cause corrosion of valves and caps.
2. Cylinders should never be subjected to rough or careless handling. Cylinder carriers or carts should always be used for moving cylinders. Cylinders in use or in storage should be properly secured.
3. Cylinders should be inspected before use. Damaged cylinders or valve components should be tagged and the cylinder returned to the filler. No attempt to repair a cylinder should be made by the user.
4. Cylinder labels should be legible and the contents clearly identified. Regardless of color code, the cylinder should not be used if the label is illegible.
5. Cylinder valves should be opened slowly to avoid damage or explosion caused by sudden temperature and pressure increases. Before connecting cylinders to yokes, manifolds or regulators, the valve should be slightly opened to clear dust and debris from the port.
6. Cylinder valves, connections, and regulators must be kept free of foreign materials. Never attempt to lubricate a gas fitting and avoid exposing any fitting to oils, greases or any other flammable substance.
7. Connection to regulators, manifolds, and yokes should never be forced. Connection hardware is designed to prevent connection of incompatible gases and equipment. Failure to connect easily indicates incompatible or damaged fittings, and represents a potential safety hazard.

B. **Medical Gas Piping Systems**

Central medical gas supply systems offer considerable advantages in terms of safety and convenience. In various

configurations, such systems supply medical gases, medical vacuum and, in most cases, central waste anesthetic scavenging connections to surgical and medical support sites. For facilities that make regular use of pneumatically powered surgical instruments, special high-pressure control stations are available, limiting the need for cylinders in the surgical suite.

Outlets for central gas piping systems are configured as wall connections, ceiling drops, or more elaborate fixed or retractable utility drops incorporating the required gases, vacuum and scavenging services, as well as electrical outlets. The reduction in the need to routinely transport cylinders to and from the surgical areas greatly enhances the safety, sanitation, and convenience of surgical and procedural areas. As well, the additional floor space gained by eliminating cylinders in surgical suites is a significant advantage in space already crowded with anesthesia machines and patient support and monitoring equipment.

In planning a central supply system, it is important to work with architects and mechanical engineers experienced in operating room design, and it is essential that the end users are included in decisions concerning the location, number and types of services required for research animal facilities.

There are several common styles of outlets, including several proprietary "quick disconnect" designs, all intended to prevent misconnections. If a connection style is already in use in the facility, it is best to maintain the style in new construction or renovation in order to maintain flexibility in relocating equipment.

III. ANESTHETIC MACHINE COMPONENTS

A. **Introduction**

In its simplest form, an anesthetic machine must control fresh gas flow, provide a means of delivering the fresh gas to the patient, and control the concentration of anesthetic vapor delivered. A method of disposing of waste anesthetic gas may be incorporated into the machine, or may be added as a separate component. Additional components include provisions to assist ventilation, such as adjustable pressure limiting (APL) valves and reservoir bags, absorber systems to remove exhaled carbon dioxide and minimize fresh gas and anesthetic agent use, and connections for both small and large tanks or central gas supplies. More complex machines and workstations often include integrated ventilators and controls, multiple gas flowmeters, auxiliary gas outlets, monitors, etc. The basic components are discussed below.

Human anesthesia equipment is subject to various national and, in some cases international, standards. This is not always the case for veterinary equipment, although some veterinary equipment makers do conform to selected standards. In this and subsequent sections the term "current standards" generally refers to human anesthesia machines.

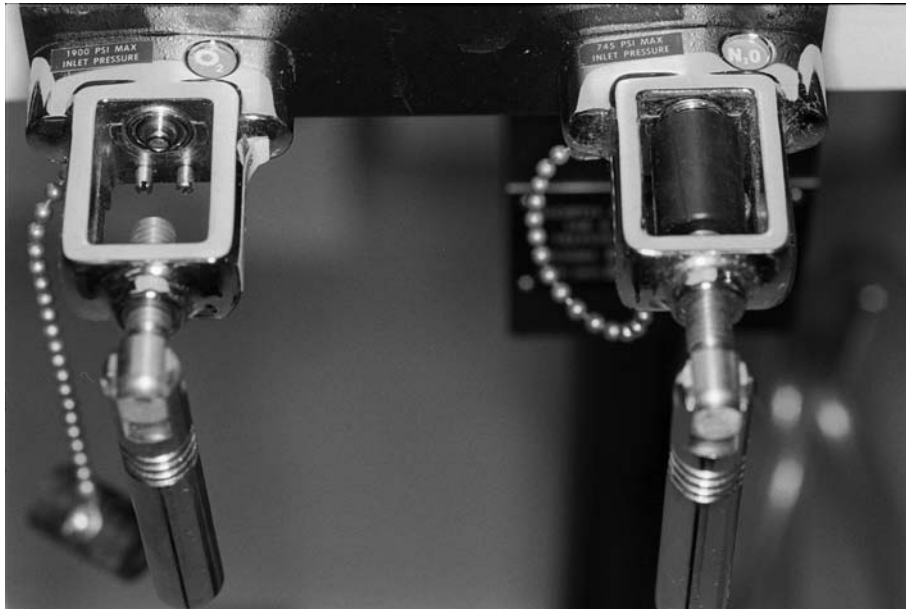

Fig. 5-2 Small Tank Yoke. The flush-type port, Pin Index System pins and retaining screw are seen on the left. The right yoke is not in use, and is protected by a yoke plug.

B. Yoke Assemblies

Oxygen and other gases enter the anesthetic machine either from a small tank yoke (Fig. 5-2) or from a connection to a large tank or central supply system. The cylinder yoke assembly includes a flush-type port, a filter to remove debris from the gas, and a retaining screw to secure and support the cylinder. On some machines, including all current human models, a single stage regulator with a check valve is a part of the yoke assembly. The check valve prevents loss of gas from the machine when small cylinders are not mounted and also prevents cross-filling of cylinders when both centrally piped supply lines and small cylinders are connected (Dorsch and Dorsch, 1999a; Petty and Sosis, 1997b).

Small tanks are supported in the cylinder yoke by a retaining screw that mates with a conical depression on the valve assembly of the cylinder. Two types of seals are used. Some manufacturers use a metal-bound washer with a soft synthetic rubber center. This style is reusable. The second style is a plastic washer, also called a crush gasket, usually supplied with the cylinder. Crush gaskets are intended only for single use and, in comparison to reusable sealing washers, require greater force to attain a tight seal. Only a single gasket should be needed: if a gas-tight seal cannot be made with a single new crush gasket, either the tank or the yoke is faulty. The tank should be removed from service, or the yoke repaired. A recent FDA-NIOH safety notification illustrates and describes the dangers associated with improper use of crush gaskets (U.S. Food and Drug Administration, Center for Devices and Radiological Health, 2006).

The small cylinder yoke should conform to the Pin Index Safety System. If it does not, or if the index pins are damaged, the assembly should be replaced or repaired to conform to this minimal safety standard. In the absence of a cylinder, yoke plugs are used to protect the port from dirt and damage and to further limit the escape of gas from the machine. On new machines, the yoke plug is usually chained to the yoke assembly. Missing plugs should be replaced.

C. Central Supply Connections

Noninterchangeable threaded connections are used to connect the machine to large cylinder or central piped gas supplies (Fig. 5-3). In the United States, the inlet is a male fitting conforming to Diameter Index Safety System (DISS) designed to prevent misconnections (Fig. 5-3). The inlets include a check valve to prevent gas from the machine entering the central piping system, as well as gas escaping from the machine if it is not connected to the piping system. International standards are similar, but require a female connection on the machine in order to eliminate leakage if the gas line is disconnected at the machine while still attached to the central piping system (LaChappell, 2006). Pipeline pressures are usually regulated to 45–55 pounds per square inch gauge (psig) (272–375 kPa) for breathing gases (Bland, 2005b; Dorsch and Dorsch, 1999a).

D. Pressure Regulation

Gas pressure in anesthetic machines is conventionally divided into three zones: high, intermediate, and low pressure systems.

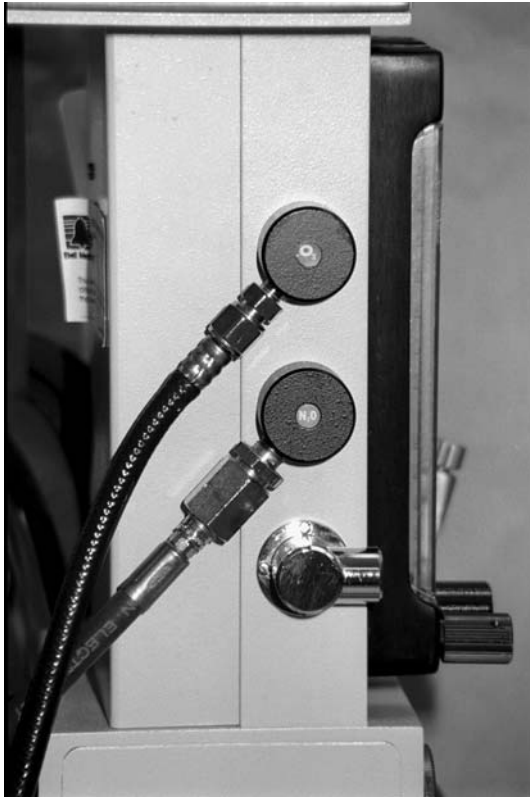

Fig. 5-3 Central Supply Connection. DISS central supply connections for oxygen (top hose) and nitrous oxide (lower hose). The chromed elbow fitting at the bottom of the photograph is the common gas outlet.

The high-pressure system refers to those components connected directly to gas cylinders. Cylinder pressure is too high for patient safety, difficult to regulate at the relatively low flows required, and variable, dropping as the cylinder contents are used. The regulator acts to lower the pressure to a safer, constant, and more easily controlled level (Dorsch and Dorsch, 1999b; Hartsfield, 1996a). As noted above, single-stage pressure regulators and check valves are standard on all but the oldest human equipment. Small cylinder yokes are often optional on veterinary machines and depend upon external pressure regulators mounted on the cylinder to accomplish the same end. For machines supplied by large tanks, a tank regulator is used to reduce the pressure to the manufacturer's suggested level.

The intermediate pressure zone comprises gases entering the machine at reduced pressure from central pipelines or from cylinders equipped with pressure regulators. This system supplies gas to flowmeter assembly, flush valve, ventilator drive, and auxiliary gas power outlets.

Pressure is further reduced as breathing gases pass through the flowmeters and to the patient breathing circuit, forming the low pressure zone of the machine.

E. Gas Supply Pressure Gauges

On veterinary machines, pressure gauges for small cylinders are typically located at the yoke. On human machines, the gauges may be located at the yoke, but are more commonly grouped with pipeline pressure gauges below the flowmeter assembly.

Pipeline pressure gauges are rare on veterinary equipment, but common on newer human machines. These usually indicate the pressure at the pipeline side of the central gas inlet, and are located on the front of the machine, below the flowmeters. This is not true for some older human machines, in which the gauge reads pressure on the machine side of the pipeline inlet connection. In the latter instance, if the small cylinder supply valves are open, the gauges will give no warning of central supply failure. A means for determining the location of the central supply sensor is described by Dorsch and Dorsch (1999b), who also recommend that small cylinder valves be closed when the machine is connected to a central gas piping system.

When connected to a cylinder, pressure gauges give an accurate estimation of the amount remaining for gases such as oxygen and nitrogen, which remain in the gas phase at normal temperatures and cylinder working pressures. As gas is withdrawn, gauge pressure decreases proportionately. However, for some gases, such as carbon dioxide and nitrous oxide, most of the contents of the tank are in liquid form at room temperature, so that gauge pressure is an unreliable indicator until the cylinder contents are nearly exhausted. Pressure will drop as gas is used, but when use is discontinued, any remaining liquid will convert to the gas phase and the pressure will again rise to a limit determined by the ambient temperature. Once the liquid contents are exhausted, gauge pressure will drop abruptly as the remaining gaseous tank contents are removed (Davis and Kenny, 2003a; Heavner et al., 1989a). Small cylinders of carbon dioxide and nitrous oxide are commonly labeled with gross and net weights and can be weighed to determine the amount of gas remaining.

F. Flowmeters

1. Variable-area Flowmeters

The most common flowmeter used on anesthetic machines is a clear glass or plastic tube, having a gradually tapered bore narrower at the bottom and wider at the top. The bore contains a float that is driven up the tube by the force of the gas flow, and stops when the weight of the float equals the force of the gas. Because the space between the walls of the bore and the float increases toward the top, the height of the float increases with increasing flow. This design is called a variable-area or variable-orifice flowmeter or, in older references, a Thorpe tube. The tube is usually etched with a scale, indicating the flow rate in liters per minute (lpm). In some cases, the scale may be located adjacent to the tube. Stops are used at the bottom and top of the tube

to limit the excursion of the float at both extremes. Veterinary machines commonly use a ball float; the flow is read at the center of the float. Alternatively, a cylindrical float, called a bobbin, is used on most human equipment. Bobbins vary somewhat in design, but characteristically have a flat top, cylindrical body, and a conical base. If the top of the bobbin is machined with small vanes, it will rotate when gas is flowing, a style often referred to as a rotameter. In contrast to ball floats, bobbins are read at the top.

Two common approaches are used to gain greater precision at low flows. On most human equipment and many veterinary machines, two tubes are connected in series, such that gas enters the first tube, usually calibrated up to 1 lpm, and then, enters the second tube, calibrated for higher flows. Each tube contains a float; flows up to 1 lpm are read on the first tube, and higher flows on the second. Dual flowmeters are available for oxygen and, on many new anesthesia machines, for nitrous oxide and medical air as well. This arrangement is especially useful for low-flow anesthesia techniques. On some machines, a single tube with a dual taper is used. A narrow initial taper indicates flow up to 1 lpm, and widens as flow exceeds 1 lpm. Current standards require a single flow controller for each separate gas, so that a single knob control operates dual tube assemblies (Diba, 2005a; Dorsch and Dorsch, 1999b). Some older machines use a separate valve for each tube, requiring the user to read both tubes and add the indicated flows to determine the total flow.

Flow is controlled by a needle valve. On new equipment, the valves are usually equipped with positive stops to prevent damage to the needle and seat due to over tightening on closure. Valves without positive stops remain common on older veterinary machines, and care is needed not to over tighten and damage the valves. Current standards require the oxygen control knob to have a distinctive fluted design. Some human anesthetic machines do not permit oxygen flow to be turned off completely; rather, a continuous minimum flow of oxygen is established once the machine is connected to the pipeline supply or when the small tanks are opened. This should not be mistaken for a faulty valve: it is a safety feature intended to prevent hypoxia.

The arrangement of flowmeters is not standard internationally. In the United States, oxygen is situated to the right of all other flowmeters whereas in the United Kingdom and elsewhere it is located on the left of the flowmeter bank (Diba, 2005a).

Variable-area flowmeters are deceptively simple in appearance and use, but are subject to a number of problems and limitations. Flowmeter tubes are individually calibrated for a specific gas. Thus, tubes will not read correctly for other gases, and the tubes and floats are not interchangeable. Damaged tubes should be replaced as a unit (Dorsch and Dorsch, 1999b; Hartsfield, 1996a). Unless specifically designed otherwise, flowmeters must be vertical to operate correctly; if the float contacts the side of the tube, friction will cause erroneous readings. Dirt, debris, and static electricity can also interfere with the free movement of the float. Needle valves are subject

to wear, and require periodic adjustment, or replacement. Valve replacement does not require replacement of the flowmeter tube.

2. Flow Restrictors

Flow restrictors are often used for mobile emergency medical oxygen supplies (Fig. 5-4). Essentially, a small orifice is interposed between the pressure regulator and the gas outlet; constant pressure produces constant flow. In this application, flow restrictors usually employ a rotating cylinder with a sequence of orifices of increasing size, allowing the user to select a suitable flow rate from a range of discrete settings. Flow restrictors will function in any orientation making them well suited for emergency and field applications.

Flow restrictors are used in a new class of machines designed specifically to support multiple patient circuits for rodent procedures. Because these machines are intended for relatively brief, repetitive procedures on small rodents, a predetermined fixed flow rate can be used for each patient circuit. Pressure regulators in the machine maintain constant pressure so that each patient circuit can be switched on or off independently of the others.

3. Electronic Flow Control

Gas flow can be sensed and controlled by electronic means. Several current human anesthesia machines take advantage of this and of extensive use of microprocessors to detect and control flow, and to prevent the use of hypoxic mixtures. Some



Fig. 5-4 Flotec Oxygen Flowmeter. In this flowmeter, a rotating cylinder is used to select the flow rate from a series of fixed flows. The selector dial is seen at the top, and the window below and to the left indicates the selected flow. A hose barb connection is at lower left, and the central supply connection at the lower right. Supply connections are available in many styles. A DISS connection is seen here. Credit: Courtesy of Flotec, Inc.

machines may depend entirely upon electronic detection and control, displaying only “virtual” flowmeters on a monitor. Other models, bowing to convention and familiarity, include a single variable-area flowmeter to indicate the total flow of gas to the breathing circuit. Solenoids can be used to control fresh gas supplies by opening valves to release fresh gases to the vaporizer and breathing system. The amount of gas is determined by the frequency and duration of valve opening, yielding an accurate average flow. The specific arrangements used vary with manufacturer and model of machine. In general, such electronic control systems provide better accuracy than conventional variable-area flowmeters, as well as the opportunity to include additional sophisticated safety and control functions. At least one veterinary small animal machine uses a combination of flow restrictors, solenoids, and microprocessors to deliver the desired flow rate and agent concentration which are entered by the anesthetist using a touch-sensitive screen.

G. Oxygen Fail-Safe and Proportioning Systems

Failure of the oxygen supply can be catastrophic. Most human anesthesia machines are equipped with alarms to warn the anesthetist of oxygen supply failure. Such devices are rare on veterinary equipment, placing the responsibility to monitor the supply status on the user. The specific means used to warn of low oxygen supply varies with the make and model of the machine, but all monitor supply pressure and sound an alarm when pressure falls below a predetermined minimum pressure (Dorsch and Dorsch, 1999b; Petty and Sosis, 1997c).

Proportioning systems are intended to prevent hypoxic oxygen:nitrous oxide ratios. These systems may use mechanical linkages, pneumatic systems, or more recently, electronic sensors. They operate to prevent the oxygen content of the mixture falling below a safe level, usually about 25%. On some machines, loss of normal oxygen pressures will interrupt or proportionately reduce nitrous oxide flow.

Most research facilities employ used or reconditioned human machines. Because of the diversity of safety features, and their increase in number and complexity over time, it is essential that the user clearly understand the function, operation, and limitations of the machine.

H. Oxygen Flush Valve

The oxygen flush valve is usually located on the front of the machine and is provided with some form of protection against accidental activation. When the valve is activated, fresh oxygen is delivered to the common gas outlet at the rate of 35–75 lpm, bypassing the flowmeters and vaporizer. Flush valves are usually spring-loaded and close as soon as pressure on the button is released.

Activating the flush valve will result in rapid dilution of the anesthetic gases in the patient circuit. Although the volume of

the absorber assembly and breathing tubing usually acts to buffer pressure changes, a dangerous increase in breathing circuit pressure may still occur. The adjustable pressure limiting (APL) valve or “pop-off” valve should be fully open when the flush valve is activated. Circuits that do not make use of the absorber system, such as Bain circuits, have a limited ability to buffer abrupt pressure changes. Because of the risk of barotrauma, the flush valve should not be used with these or other nonbreathing circuits. Instead, anesthetic agent levels in the circuits can be rapidly altered by changing the concentration at the vaporizer and briefly increasing fresh gas flows using the flowmeter.

I. Common Gas Outlet

The common gas outlet (Fig. 5-3) is the point at which the mixture of breathing gas and anesthetic agent exit the machine and, by means of a connecting hose, enter the breathing circuit. Older machines and most veterinary machines use a 15 mm female tapered connection. In addition to the 15 mm female connections, newer equipment used in humans may include a coaxial 22 mm male connection. The 15 mm connection is the same size as an endotracheal tube connector. Current standards for human anesthesia machines require a retaining mechanism to limit accidental disconnection. Depending upon the manufacturer, model, and intended use, veterinary equipment may vary considerably from the description given above.

J. Absorber Systems

Absorber systems are used with circle breathing circuits to remove carbon dioxide from exhaled breathing gases so that they may be reused, reducing fresh gas requirements, and conserving volatile anesthetic agents, moisture, and heat. Absorbents are granular materials, typically comprised of calcium hydroxide and water, with small amounts of potassium, sodium or barium hydroxide to speed up the uptake of carbon dioxide. A certain amount of water is essential for the absorbent to function properly. Carbon dioxide is removed by an exothermic chemical reaction with the formation of calcium carbonate. A color change, indicated by pH-sensitive dyes, signals that the absorbent is exhausted.

Sevoflurane is known to degrade in the presence of absorbents to produce a product called Compound A. At low levels, Compound A has not proven to be clinically significant in humans, although it has been shown to be nephrotoxic at high levels in rats (Kharasch et al., 2002). However, absorbents containing sodium or potassium hydroxide can also degrade desflurane, isoflurane, and sevoflurane with the formation of carbon monoxide. Dorsch and Dorsch (1999c) summarized the conditions leading to the greatest degradation and identified desiccated absorbents as the most important factor, absorbents containing barium hydroxide being the most commonly implicated. Baralyme[®] is no longer available in the United States and Europe, and most absorbents

have been reformulated to reduce or eliminate the use of potassium and sodium hydroxide (Kharasch et al., 2002; Olympio, 2005). General recommendations emphasize measures to avoid drying absorbents, such as turning off gas flow completely when the machine is not in use, changing all absorbent when the indicator changes color, and changing absorbent regardless of color indicator if it has not been used for some time (Coppens et al., 2006).

Absorber assemblies are usually located in the inspiratory limb of the breathing circuit, with the inspiratory valve located on or adjacent to the absorber assembly. The absorber frequently is integrated into a block containing the unidirectional valves, adjustable pressure relief valve, and circuit manometer. The absorbent is contained in a transparent or translucent housing. On some machines, the housing will accept either loose or prefilled canisters, and may include a dust and moisture trap. Dual canister absorbers are used on some human and veterinary machines to extend the interval before the absorbent change is needed. The configuration of absorber assemblies varies in detail, but in all designs, exhaled gas is directed through the assembly by way of unidirectional valves. The fresh gas inlet for the circle system is located near or on the assembly, usually adjacent to the outflow side.

Disposable absorber systems are used on some veterinary and human machines. They are available in a number of configurations, including complete assemblies with integrated circuits, unidirectional valves, and pressure relief valves. If equipped with filters, complete assemblies are sometimes used to protect the machine from contamination when patients with infectious diseases are anesthetized.

Absorbents are sold in sealed packages designed for one filling, prefilled canister inserts to fit many common absorber canisters, and in bulk containers. While the bulk supplies are less expensive per unit weight, they are more difficult to seal and are best used in facilities with relatively high workloads. Absorbents should be cleaned when they are refilled to remove dust and caked absorbent. In order to minimize leaks, absorbent granules and dust should be removed from the canister rim and seals before closing the canister.

K. Unidirectional Valves

Unidirectional valves direct the flow of gases in circle systems to prevent rebreathing of expired gases (Fig. 5-5). In most human and veterinary machines, the valves are thin discs arranged horizontally on carefully machined ports, in metal or hard polymer housings. Discs may be made of several materials but are, in any case, light to reduce resistance to breathing, and flat to ensure a tight seal with the port. In many designs, a cage is used to confine the disc and prevent displacement. Gases entering the valve force the disc up, permitting flow through the port. Flow in the opposite direction forces the disc onto the seat, sealing the port. Thus, for the inspiratory valve, when

the patient inhales, pressure is reduced in the dome and the valve rises allowing gas to flow. At the same time, lower pressure in the expiratory valve port causes the disc to seal the port, stopping the flow. Upon exhalation, pressures in the circuit are reversed, sealing the inhalation valve and opening the exhalation valve. Clear plastic domes cover the valves, to allow inspection during anesthesia and testing. The domes are removable to permit cleaning and disc replacement. Current standards require the valves to be clearly labeled to indicate their proper connection to the breathing hoses. Valve housings have standard 22 mm diameter male connections for breathing hoses.

Breathing valves are subject to accumulated moisture and debris and should be cleaned regularly to prevent valves from sticking. Care is needed during reassembly to assure that the discs, cages, and gaskets are correctly seated. Correct valve function should be observed when the machine is checked and tested before use, as well as during anesthesia.

L. Adjustable Pressure-Limiting Valve

The pressure in the circle breathing system is controlled by the APL valve or "pop-off" valve (Fig. 5-5). The APL valve is ordinarily located on or adjacent to the absorber assembly between the absorber and the expiratory unidirectional valve. On most veterinary and older human machines, the reservoir bag connection is often incorporated into the APL valve assembly. Although the specific design varies with the manufacturer, all APL valves can be gradually adjusted from fully open to fully closed, imposing progressive resistance to gas escape. Some APL valves are equipped with a safety relief feature to protect against either negative pressure in the breathing circuit, or abnormally high pressure. Even when the APL valve is fully open, a slight degree of opening pressure is maintained to prevent constant loss of breathing gases. This slight positive pressure is enough to fill the reservoir bag, without adverse consequences. Loss of the specified opening pressure through damage or corrosion can result in uncontrolled loss of gas from the breathing circuit and difficulty in regulating the scavenging system (Hallowell, 2006). Gas exits the valve via a 19 or 30 mm fitting leading to the scavenger interface. During spontaneous breathing, the APL valve is normally fully open except when manually assisting ventilation patients.

The scavenging port connections are sized to prevent connection to 22 mm breathing hoses. Nineteen or 30 mm tubing is inexpensive and readily available, so there is little reason to attempt to circumvent this safety feature with 22 mm tubing and ad hoc connections.

M. Reservoir Bag

The reservoir, or breathing bag, attaches to the bag port, usually close to, or part of, the APL valve assembly. At the beginning of inspiration, very high momentary flows are needed; for larger patients, the flows required could exceed the flowmeter limits of



Fig. 5-5 Breathing System Manometer. The gauge is located between the inspiratory valve and the absorber assembly on the left and the expiratory valve and APL valve on the right.

the machines. The bag serves as a volume reservoir to meet the demands of ventilation, allowing lower, and more economical, fresh flows to be used. Most reservoir bags are elastic. There is a limit at which the volume will continue to increase, but with no further increase in pressure (Davis and Kenny, 2003b). This feature provides a degree of protection against high breathing circuit pressures. The maximum pressure reached for small breathing bags of up to 1.5 liters is 50 cm H₂O at four times the nominal volume; for bags greater than 1.5 liters, the pressure limit is 60 cm H₂O, but these pressures may be exceeded if non-compliant bags are used (Davey, 2005a; Dorsch and Dorsch, 1999d). While the reservoir bag must at least accommodate the demands of a single tidal breath, in practice larger bags are used. For veterinary patients, Lerche et al. (2000a) recommended using reservoir bags of 3–5 times the tidal volume of the patient.

Both reusable and disposable reservoir bags are available in a variety of sizes. Disposable bags are thinner, lighter than reusable bags, reasonably durable and hence preferred. With time, reservoir bags deteriorate; they rank high on the list of the usual suspects when the machine fails a pressure test. Typically cracks or holes occur at the neck of the bag where it joins the bag port adaptor.

N. Breathing System Manometer

The pressure in the breathing circuit is usually expressed in centimeters of water, measured by an aneroid manometer located in the breathing circuit (Fig. 5-5). The manometer is an important safety component, used not only to assure appropriate inflation pressures during assisted or controlled ventilation,

but also to detect or avoid dangerously high pressures due to operator error or mechanical malfunction. The manometer indicates negative as well as positive pressure, i.e., it indicates pressure below ambient, as when a patient attempts to inspire in the presence of an empty reservoir bag, or independently of a mechanical ventilator, or a malfunction in certain active waste gas scavenging systems. Circuit manometers register relative, not absolute, pressure. The indicator needle should move smoothly in response to pressure changes, and should indicate zero pressure when the breathing circuit is not in use. Time and exposure to pressure extremes can result in loss of calibration which should be corrected before continued use.

O. Vaporizers

Vaporizers convert volatile liquid anesthetics into gases, which are then added to the breathing gas mixture. A number of classification schemes are used for vaporizers including method of output regulation, method of vaporization, location in the breathing circuit, agent specificity, and temperature and pressure compensation. In the following section, vaporizers that permit accurate selection of the final concentration of vapor in the breathing circuit are called precision vaporizers. Neither nonprecision vaporizers nor measured flow vaporizers (with two exceptions) are discussed in detail. While older nonprecision vaporizers and measured flow vaporizers remain in use for some veterinary and selected human applications, in general they require different and greater skills for safe use than precision variable bypass vaporizers. Readers interested in these vaporizers should consult the anesthesia equipment references listed in “Additional Reading” section. The vaporizers discussed

below are all located out of the breathing circuit, and are, with the exception of electronic designs, variable bypass precision vaporizers.

1. Variable Bypass Vaporizers

Variable bypass vaporizers are the most likely to be encountered. All of the fresh gas exiting the flowmeter block is directed into the vaporizer where the flow is divided: a small portion diverted into the vaporizer chamber, while the greater portion bypasses the chamber. Wicks are used to maximize the surface area for evaporation of the anesthetic agent in the chamber, so that the fresh gas becomes saturated with the agent. The diverted gas, now saturated with vapor, leaves the chamber and joins the main flow before exiting the vaporizer. The ratio of diverted gas to total flow is determined by the vapor pressure of the agent and the desired concentration of the agent in the fresh gas. Thus, the vaporizer is agent specific. A dial or hand wheel is used to select the desired concentration, and output is indicated in volume percent. Most modern vaporizers are equipped with a positive On/Off mechanical lock, usually a button, which must be activated before the vaporizer can be turned on. As with variable-area flowmeters, the first concentration on the dial is the first reliable reading. Some vaporizers will not deliver the agent below the first indicated value.

The output is affected by a number of physical factors including temperature, pressure, fresh gas flow rate, and carrier gas composition. As fresh gas passes through the vaporizer chamber and removes the volatile agent, the temperature in the chamber drops. The vapor pressure of volatile anesthetic agents varies directly with temperature, so the output is affected. Modern vaporizers have mechanical or, in some cases electronic, means of compensating for the effects of temperature. Mechanical methods generally depend upon thermal expansion or contraction of fluid-filled pistons, bimetallic strips, or mated metal surfaces to proportionately vary the resistance of the chamber outlet, to maintain a constant output. A notable feature of most vaporizers is their weight. Many vaporizers enclose the vaporizing chamber with a relatively large mass of metal to act as a heat sink and an additional buffer against temperature changes. Some older vaporizers instead included a thermometer in the vaporizing chamber and provided a table of vapor pressure versus temperature chart to allow for manual adjustment of the concentration.

Pressure variations in the breathing circuit, as with mechanical ventilation, affect vaporizer output. This is also addressed in modern vaporizers by several methods to minimize the effect of backpressure. Flow dependency, the variation in output at different fresh gas flow rates, also alters the delivered vapor concentration. The relationship between the concentration set on the dial and the actual concentration at any given flow is referred to as *linearity*. The linearity varies among vaporizer models. This information is provided with new vaporizers, usually presented as a chart showing measured vs. dial concentration at

varying flow rates, and is available from the manufacturer and in anesthesia equipment texts and papers. Many older vaporizers, still in common use in veterinary and research facilities, are not linear below flow rates of 0.5 lpm. With the increasing popularity of low-flow techniques, new vaporizers are designed for greater precision at low flows. The carrier gas composition, when nitrous oxide is used, has an effect on the output, but is not ordinarily clinically significant (Davey, 2005a).

In addition to the control wheel, vaporizers have a filling port, a sight glass to indicate fill level, a drain port, and a means of connecting to the gas supply and breathing circuit. Many older vaporizers used funnel-filling ports. This style of filling port is more prone to spillage and personnel exposure to volatile agents, and allows filling with the wrong agent. In this event, the vaporizer must be drained and cleaned, and may require service before further use. If funnel-style filling ports are used, a pouring adaptor for the agent bottle will increase control and reduce spillage during filling (Fig. 5-6). Before opening the filling port, the funnel should be cleaned to avoid carrying debris into the vaporizer chamber. Keyed filling adaptors use a tube with an agent-specific connector for the vaporizer and bottle, greatly reducing the chance of misfilling, environmental contamination, and foreign material in the chamber (Fig. 5-7). The sight glass is a window or a tube marked to show the maximum permissible filling level. Vaporizers should not be over filled as this can result in delivery of dangerously high anesthetic agent levels. In most cases, the vaporizer must be turned off and fresh gas flow discontinued during filling. Because this is an inconvenient process during anesthesia, the agent level should always be checked before the onset of a case. Failure to secure the filling port cap before the carrier gas is turned on will result in a gas pressure forcing liquid agent out of the filling port, resulting in personnel hazard and wasting agent.

The drain port is used to empty the vaporizer chamber for storage and service. Few vaporizers are completely vapor tight, and a small amount of agent will be lost over time. The vaporizer should be drained before storage, transport, or extended periods of disuse. By design, vaporizers are mounted and used in a vertical position. While some newer designs are relatively tolerant



Fig. 5-6 Pouring Adaptor. A pouring adaptor replaces the original bottle cap. The adaptor minimizes spills during filling of vaporizers with funnel filling ports. The adaptor is color-coded and will fit only the correct bottle of anesthetic agent.

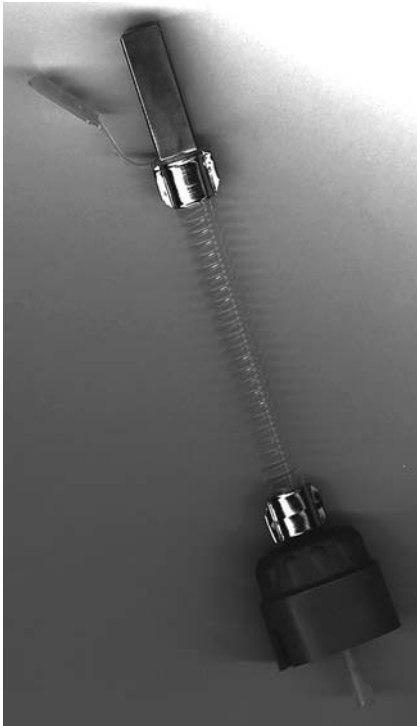

Fig. 5-7 Keyed Filling Adaptor. The keyed filling adaptor has keyed stainless steel fittings to fit the vaporizer and the anesthetic agent bottle, and provides a path for air to escape as the vaporizer is filled. Credit: Courtesy of Sharn Anesthesia.

of tipping, many older designs are not, and will deliver high, uncontrolled levels of anesthetic vapor if the control mechanism is wetted with the liquid agent.

Several different mounting arrangements are used to attach the vaporizer to the anesthetic machine. Most veterinary machines use the cage mount system (Fig. 5-8). In order to assure a compatible mounting connection to the machine it is best to seek advice from the vaporizer or machine vendor or a qualified service technician. When two or more vaporizers are mounted on the same machine, lockout mechanisms should be used to prevent simultaneous use. Vaporizers should not be linked in series without a positive lockout mechanism. While the design of the lockout system varies with the machine maker, such arrangements have been used on human equipment for many years, and are now available on some veterinary machines as well. Vaporizers should be placed between the flowmeters and the oxygen flush valve. The practice of connecting a vaporizer between the common gas outlet and the breathing system is dangerous because activation of the flush valve will direct high gas flows through the vaporizer, leading to uncontrollable increases in agent levels (Andrews, 1990). Typical examples of variable bypass vaporizers are seen in Figs 5-8, 5-9, and 5-10. Tec 3 style vaporizers achieved widespread popularity when they were first produced. The patent has long expired, but these vaporizers continue to be made, with some design changes, by several manufacturers.



Fig. 5-8 Tec 3 Style Vaporizer. A Pentec 2-methoxyflurane vaporizer. The exterior appearance of this older Cyprane vaporizer is the same as current Tec 3 vaporizers. The filling port at the lower right is a funnel fill; the cap is reversed to fit the drain port. While this model is no longer in production, Tec 3 vaporizers for halothane, isoflurane, and sevoflurane remain popular and are produced by several manufacturers.



Fig. 5-9 Dräger Vapor 19.1 Vaporizer. The 19.1 series precision vaporizer is no longer produced, but is still widely used. The 19.n series was noted for its linearity over a wide range of flows and for its durability. The funnel filling port is at the center lower right, with the drain port below it. Credit: Courtesy of DREVeterinary (www.dreveterinary.com).



Fig. 5-10 Penlon Sigma Delta Vaporizer. This new vaporizer is made of aluminum, and is unusually light. It has improved linearity and, except for halothane models, a recommended 10-year service interval. Credit: Courtesy of DREVeterinary (www.dreveterinary.com).

An unusual variant of the variable bypass vaporizer is found on the Datex-Ohmeda ADU workstation, which uses the Aladin vaporizer. In this electronically controlled machine, the vaporizer control unit is located above the pressure gauges on the front of the machine above the work shelf. The vaporizer chamber, or cassette, is removable from the vaporizer control system. Cassettes are agent specific and coded so that the vaporizer control module recognizes the agent being used. Cassettes are available for all currently used agents, and can be stored on the machine. The system uses electronic pressure sensors and control valves in the vaporizer chamber and the bypass circuit to detect and control carrier gas flow and uses that information in conjunction with temperature sensors to calculate the delivered agent concentration (Davey, 2005b; Dorsch and Dorsch, 1999e; Hendrickx et al., 2000).

Vaporizers are not maintenance-free. A qualified service technician should check vaporizer performance at least annually. While a calibrated agent analyzer can be used, most field service personnel use a specialized refractometer and large organizations may find it convenient to purchase the necessary equipment. A vaporizer not performing as expected should be withdrawn from use and serviced. The degradation of vaporizer

output can occur gradually, emphasizing the importance of regular validation. Output validation is not the same as vaporizer service, which involves disassembly, repair and replacement of worn or defective components, as well as calibration. Anesthetic vaporizers are not user serviceable. Service recommendations are specified by the manufacturer, and vary from annually to “as needed,” depending upon the specific model. While the vaporizer is being serviced, many vendors provide replacement vaporizers, minimizing the inconvenience. Properly calibrated anesthetic agent monitors are especially useful to monitor vaporizer performance.

2. Measured Flow Vaporizers

The original models of measured flow vaporizers have long been out of production. Newer versions made primarily for military field anesthesia are in use, but neither these nor older models are discussed at length here. Readers interested in these vaporizers should consult the texts listed under “Additional Reading.” The earlier editions of these texts contain extensive information about older equipment.

In measured flow vaporizers, gas exiting the vaporizer is fully saturated with the volatile agent. Separate flowmeters are used for the vaporizer and gas flow to the patient breathing circuit. The operator regulates the required flow to the vaporizer, and the fresh gas flowmeters, so that the combination of the vaporizer output and the main flowmeter output corresponds to the desired concentration of agent in the breathing circuit. In older machines, the calculations required were accomplished with a circular slide rule which took into account total desired flow, final concentration of agent, and temperature (hence vapor pressure of the agent) in the vaporizer, thereby yielding the correct flowmeter rates for the vaporizer and the main flowmeters. With experience, those adept at mental mathematics can dispense with the calculator. With the increasing application of microprocessors and electronic sensors in medicine, measured flow vaporizers have reappeared in new form.

Because desflurane has an unusually high vapor pressure, boiling at 22.8°C, a conventional vaporizer cannot be used (Eger et al., 2002). Users of Tec 6 desflurane vaporizer will find thorough descriptions of it in Davey (2005a) and Dorsch and Dorsch (1999e). That these texts differ in their classification of the vaporizer is an indication of the novel design. Briefly, the vaporizer is heated to a constant temperature to vaporize the agent. Electromechanical sensors and controls in the chamber and in the fresh gas flow paths act, in concert with the concentration dial, to proportionally alter the flow of agent vapor into the fresh gas pathway. A series of light emitting diode (LED) lights and a bar graph display vaporizer functional status and agent level in the vaporizer chamber. A specialized filling port is used to connect the agent bottle to the vaporizer chamber.



Fig. 5-11 MK-1-IS Veterinary Anesthesia Machine. The vaporizer and flowmeter module is seen at the left. Note the touch-sensitive control panel. In the center is a clear plastic absorber assembly with integrated unidirectional valves, APL valve with scavenging connection (top), and reservoir bag port. The breathing system manometer is seen at the top right, as well as the breathing circuit connections. Credit: Courtesy of Mark Kenny Products Company, LLC.

A novel veterinary anesthesia machine has recently been introduced which makes use of electronic and electromechanical controls to deliver gas to the breathing circuit over a range of discrete combinations suitable for clinical anesthesia. The MK-1-IS Veterinary Anesthesia Machine (Mark Kenny Products Company, LLC, Newtown, CT) employs an agent bubble-through chamber with a temperature sensor (Fig. 5-11). A solenoid-actuated valve controls the gas flow to the chamber; the larger fresh gas flow bypassing the chamber is controlled by a second valve. The frequency and duration of valve opening is determined by a microprocessor, using an algorithm that takes into account the vapor pressure of the agent at the temperature of the vaporizing chamber and the desired patient circuit gas flow, to determine the flow through the vaporizer chamber. The flow thus occurs in multiple bursts whose frequency and duration determine the average minute flow to the breathing circuit. The user selects the agent concentration and total gas flow by means of pressure-sensitive arrows on the front panel of the machine. The control panel also allows the user to set altitude, or barometric pressure, to compensate for output variations if the machine is used at higher altitudes. The oxygen flush, as well as alarm settings signaling high and low agent concentrations, is also controlled using the control panel. The machine can use isoflurane or sevoflurane, by selecting the agent on the control panel. A purging procedure is used to clean the vaporizer when changing agents. In assessing the control of gas to the

vaporizer and breathing circuit, this machine appears to use an electronically controlled measured flow vaporizer.

P. Scavenging Systems

Waste gas scavenging and monitoring are discussed in more detail in the following two chapters. In this section, only the arrangements commonly found on anesthesia machines are briefly described and illustrated. Scavenging systems comprise collection devices, interfaces, and disposal systems. The most common collection device is the APL valve, used for circle systems, and some types of nonrebreathing circuit adaptors. Other nonrebreathing circuits, such as Mapleson-E and F circuits, discussed in a following section, do not use an APL valve. In this case, waste gas is conducted directly from the circuit or reservoir bag to the interface.

Two types of scavenging are used. *Active* scavenging makes use of a fan or vacuum pump to provide continuous low pressure at the scavenging interface, drawing the waste gas into the disposal system. Vacuum systems use narrow gauge tubing to conduct gas to a central suction system, and generate a large pressure differential. Fan-driven duct systems operate at much lower pressure differences and employ wide gauge tubing and ducts to remove a high volume of gas. *Passive* scavenging uses the pressure generated in the breathing circuit to drive gas to the interface.

The interface may be *closed* or *open*. In either case, some means to avoid transferring either high or negative pressure to the APL valve is needed. If the conduit to the disposal site is blocked, high pressures may occur in the interface. If active scavenging is used, there is the potential to transfer negative pressure to the APL valve. In a closed interface, seen in Fig. 5-12, unidirectional spring-loaded valves are used to isolate the interface from the room. A breathing bag serves to accept brief high flows of gas from the APL valve. If passive scavenging is used, a valve opens when the pressure in the system rises to a preset level, venting gas into the room. With active scavenging, two valves are used to protect the breathing system. One valve opens in the event of high pressure, while the second valve opens if the pressure in the interface drops below ambient, to avoid emptying the breathing system. Active scavenging systems ordinarily have an additional valve to regulate the suction from the vacuum or duct system.

Open interface systems, seen in Figs 5-13 and 5-14, are open to the room, although the location of the opening varies among models. In this case, no valves are required and the safety of the system depends on uninterrupted suction, so these systems must have a visible flow indicator. In most cases, this is an integral flowmeter and valve to regulate the suction at the interface.

Charcoal canisters are sometimes used in situations where no other means of scavenging is available. Their advantages and limitations are discussed in Chapter 7.

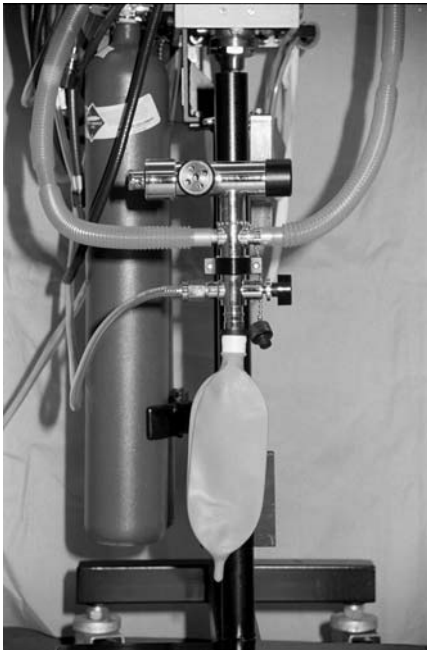

Fig. 5-12 Closed interface active scavenging system. The 19 mm corrugated hose on the right is connected to the APL valve scavenging port. The hose at the left is connected to the ventilator relief valve. Positive and negative pressure relief valves are located in the cross bar assembly immediately above the corrugated hose connections. The small diameter clear tubing is connected to the central scavenging vacuum system. Opposite it is the vacuum adjustment needle valve. The scavenging reservoir bag is seen at the bottom.



Fig. 5-13 Open Interface Scavenging System. This example is designed for a central vacuum system. The vacuum adjust needle and flowmeter are seen at the top. The white hose connects to the central vacuum scavenging system, and the two corrugated hoses are connected to the APL valve scavenging port, and the ventilator relief valve. The cylinder is a rigid reservoir. The openings to the room are not visible in this photograph.



Fig. 5-14 Open Interface Scavenging System. This interface has a vacuum control flowmeter and needle valve and may be mounted on the anesthesia machine, or directly on the central vacuum scavenging port as shown. The black corrugated hose is connected to the scavenging port of the APL valve. A second connection is available at the top of the reservoir bag, and is capped when not in use. The open connection to room air leads through a charcoal canister that serves as a backup in the event of vacuum failure. Credit: Courtesy of Hallowell EMC.

Scavenging interfaces require periodic cleaning to remove accumulated dust, hair, and other debris, a particular concern with closed scavenging interfaces.

IV. BREATHING CIRCUITS

A. Introduction

Breathing circuits provide oxygen to the patient and remove waste products. If volatile anesthetics or gases such as nitrous oxide are used, provisions for scavenging are essential. The design and fabrication of breathing circuits and the study of their characteristics and performance remain active areas of research, offering considerable scope for the inventive mind. The number of circuits, valves, adaptors, and related devices that are commercially available is so great that even experienced anesthesiologists are unlikely to be familiar with all of them. The principles of circuit design and function are well covered in standard texts, continuously supplemented by a large and growing literature. Those tempted to design or modify breathing circuits should carefully consult the literature; the subject

is considerably more complex and subtle than is apparent, and there are numerous pitfalls for the unwary. Fortunately, only a few types of breathing circuits are needed to accomplish a wide range of anesthetic tasks.

B. Dead Space

The inspired air that enters the respiratory passages but does not reach the alveoli or reaches poorly perfused alveoli does not participate in oxygen–carbon dioxide exchange. In the patient, the total volume occupied by the gas that is not losing oxygen or gaining carbon dioxide is called *physiologic dead space*. The volume accounted for by upper respiratory structures—the nose, pharynx, trachea, and bronchi—is called *anatomic dead space*. The volume occupying under- or unperfused alveoli is called *alveolar dead space*. Anesthesia equipment can add *mechanical dead space*. The mechanical dead space should be minimized. For example, an endotracheal tube trimmed to the proper length does not increase dead space and, usually, decreases it. However, if the tube extends far beyond the mouth of the patient, dead space is increased. If an airway filter, elbow connection, or gas sampling connector is added between the endotracheal tube and the breathing circuit, mechanical dead space is further increased. For small patients, a low-dead space endotracheal tube connector is especially useful (Fig. 5-48). Lerche et al. (2000a) give a useful estimation of the dead space of commonly used connectors. Circle systems with competent unidirectional valves and properly functioning absorbers contribute relatively little dead space (Gravenstein et al., 1989).

C. Materials

Anesthesia circuits are made of synthetic rubber or plastic. Although the heavy conductive rubber components remain available, they are less commonly used. Instead, lightweight, translucent, plastic circuits are generally preferred. Silicone circuits, although heavier and more expensive than their lighter counterparts, have the unique advantage of being autoclavable. Complete disposable circuit assemblies can be purchased to meet almost any need, or circuits can be assembled using common connectors and bulk tubing. Standard breathing tubing has an internal diameter of 22 mm.

Breathing circuit tubing is typically corrugated, providing flexibility and resistance to kinking or collapse. The corrugations also make the tubing more compliant or distensible. Circuit compliance is important because the gas lost in distending the circuit does not reach the patient. With mechanical ventilation in smaller patients, the proportion preset tidal volume that is lost due to circuit distention can be considerable, leading to hypoventilation despite apparently adequate volume settings. The compliance and the resistance to breathing increase with the circuit length; the circuits should be no longer than needed.

Volatile anesthetic agents are absorbed by many polymers used in breathing circuits, the extent varying with the volatile agent and the specific polymer. In general, the least soluble agent is desflurane, followed by sevoflurane, isoflurane, and halothane, a ranking consistent with their oil:blood partition coefficients (Targ et al., 1989). In terms of materials, rubber and polyvinylchloride absorb considerably more agent than polyethylene or polypropylene (Smith et al., 2002; Targ et al., 1989).

While leakage of gas through the walls of tubing is of minor significance in terms of pollution, absorption of volatile agents can affect uptake and washout studies, as well as the precautions needed to prepare an anesthetic machine for patients at risk for malignant hyperthermia (Smith et al., 2002). However, a major part of the pollution from breathing circuits is caused by leaks, such as ill-fitting masks and endotracheal tubes, and the failure to thoroughly flush the breathing system with oxygen before disconnecting the patient. Turning off the vaporizer and doubling or tripling the oxygen flows while periodically emptying the breathing bag through the APL scavenging connection substantially reduces the pollution (Cornick-Seahorn et al., 1996).

D. Classification

Terms such as *open*, *closed*, *semi-open*, and *semi-closed*, among others, have been used in a variety of classification schemes. Various authors understand these terms differently and the result is a confusing array of classification schemes. This situation has recently been worsened with the advent of newer human workstations in which the rebreathing systems have been further modified to improve the performance and safety of their integrated ventilators. Only a few types of circuits are commonly used and their conventional configurations are described below.

E. Rebreathing Systems

Although it is not the simplest breathing system, the conventional circle system, using the unidirectional valves and carbon dioxide absorber systems described earlier, remains the most commonly used breathing circuit for larger patients (Fig. 5-15). Removal of carbon dioxide and recirculation of the remaining gases reduce the consumption of volatile anesthetic agents and fresh gas. With moderate flows, some heat and moisture are also retained and, with appropriate monitoring, the same circuit is suitable for low-flow techniques. Correct function of the absorber system and unidirectional valves is essential in order for the circle system to perform as expected.

Circle systems have a high internal volume, including the reservoir bag, unidirectional valves, absorber canister(s), and breathing tubes. With a precision vaporizer located out of the circuit, the agent concentration in the circuit will be very slow to change when moderate and, especially, low fresh gas flows are used. If rapid changes in agent concentration are needed,

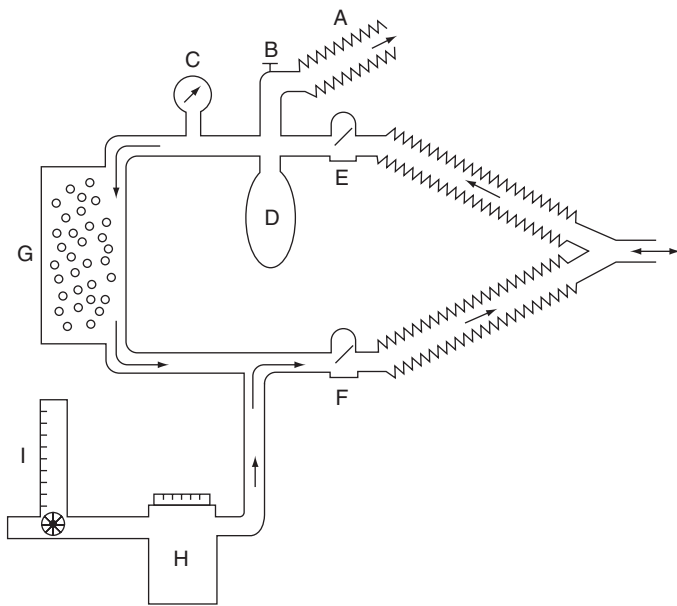

Fig. 5-15 Circle System. Circle breathing system with the vaporizer outside the circle. (A) Scavenging tubing connection at the APL valve. (B) APL valve. (C) Circuit manometer. (D) Reservoir bag. (E) Unidirectional expiratory valve. (F) Unidirectional inspiratory valve. (G) Carbon dioxide absorber canister. (H) Vaporizer. (I) Flowmeter. Arrows indicate the direction of gas flow. The patient Y-connection is at the right.

fresh gas flow rates must be increased in addition to changing the vaporizer setting. As mentioned previously, if the APL valve is fully open, activating the flush valve will rapidly reduce agent concentration in the circuit; if it is *not* fully open, the result will be a precipitous and possibly dangerous rise in breathing circuit pressure.

In human anesthesia practice, considerations of labor and liability have dictated the use of new disposable breathing circuits with each patient. These individually packaged circuits include the needed connectors, tubing, and reservoir bags and often bacterial filters. They are commercially available in virtually any combination of components likely to be needed. In veterinary clinical and research use, disposable circuits are frequently cleaned and reused. With the exception of silicone tubing, mentioned previously, few of the components are likely to withstand an autoclave; if sterilization is the goal, alternative sterilization methods must be used. In any event, it is essential to avoid irritating or toxic residues left by the cleaning method. A thorough rinsing of all components to eliminate cleaning agent and disinfectant residues is needed, in addition to the compliance with the sterilization guidelines for the method used. Plastic circuits are generally more durable than disposable breathing bags, which require more frequent replacement. An economical alternative to preassembled circuits is the use of bulk 22 mm breathing hose. This is usually supplied with noncorrugated connectors at regular intervals to facilitate connection to the machine. With the

addition of inexpensive Y-connectors, a circuit of any desired length is easily constructed.

Pediatric circle systems are available with the internal diameter tubing reduced to 15 mm. The reduction in circuit volume helps to retain heat and moisture, a particular concern with smaller patients. These circuits are recommended for use with animals weighing less than 7 kg (Bednarski, 1993). If ventilation is closely monitored and supported, the adverse effects of increased resistance to breathing attributable to the absorber and unidirectional valves are minimal. The smaller diameter circuit is less compliant than larger circuits, reducing volume losses with mechanical ventilation.

Coaxial versions of circle systems are available. In these circuits, the inspiratory limb enters the expiratory limb just beyond the unidirectional valves to form a single coaxial tube leading to the patient, reducing to some degree the clutter of lines and tubes that tend to accumulate at the head of the operating table (Fig. 5-16).

F. Nonbreathing Systems

In its current form, Mapleson's description and analysis of nonbreathing systems now includes types A through F (Mapleson, 1954). Although called nonbreathing systems, the amount of rebreathing that occurs is largely dependent upon the fresh gas flow. While these circuits differ somewhat in their characteristics, in general, the higher the fresh gas flow, the less rebreathing is liable to occur.

Four types, Mapleson-A, -D, -E, and -F, are the most likely to be encountered in the research setting (Fig. 5-17). The Mapleson systems are useful for many small patients and, in one form,



Fig. 5-16 Universal F Circuit. In this coaxial circle system the connection to the inspiratory unidirectional valve is seen at the top right and the short hose below it connects to the expiratory valve. Credit: Courtesy of King Systems Corporation.

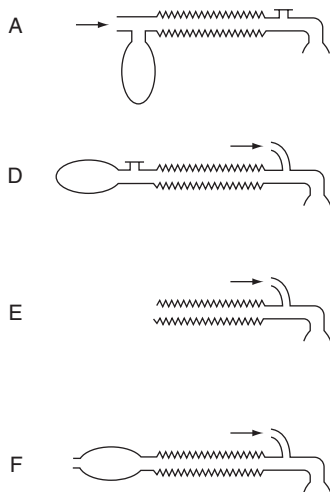

Fig. 5-17 Mapleson Circuits A, D, E, and F. Redrawn with permission of the British Journal of Anaesthesia and Dr. W. Mapleson.

are extensively used for rodent anesthesia. Many of the circuits described below are available as preassembled disposable units.

Most of these circuits deliver fresh gas close to endotracheal tube or mask connection. In the Bain modification the flow is directly in line with the patient connection. In contrast to circle systems, changes in vaporizer settings are rapidly reflected in these breathing circuits. If a rapid change in inhaled concentration is needed, altering the vaporizer setting and increasing the fresh gas flow at the flowmeter will suffice. *Activating the oxygen flush valve will deliver 35–75 lpm of oxygen into the circuit, presenting a serious risk of barotrauma. The flush valve should not be used.* Mapleson breathing systems also have a limited volume compared with circle systems, so pressure in the breathing circuit can rise rapidly when the APL valve is closed, as it is when manually assisting ventilation. The anesthetist must be scrupulous in returning the APL valve to the open position after delivering a breath. A distracted or inattentive anesthetist can be unpleasantly surprised at the speed with which the breathing circuit pressure rises to dangerous levels.

A unique modification of the APL valve, the Humphrey valve, allows greater efficiency in the use of Mapleson-A, -E, and -D circuits in terms of convenience and fresh gas flow requirements. The circuit used is selected with a single lever on the valve (Davey, 2005b; Dorsch and Dorsch, 1999f; Humphrey et al., 1986a, 1986b).

1. Mapleson-A Circuits

Figure 5-17A depicts a configuration called a Magill circuit. The fresh gas enters near the reservoir bag, flows toward the patient through a corrugated tube, and exits via a relief valve adjacent to the mask or endotracheal tube. The direction of gas flow, which forces expired gas out of the circuit very close to the patient connection, makes it very efficient for spontaneous

breathing, because alveolar gas is eliminated early during expiration (Conway, 1985). It is less efficient for assisted or controlled ventilation, and should not be used with some mechanical ventilators (Dorsch and Dorsch, 1999f). The circuit is somewhat clumsy in use because of the location of the relief valve and the scavenging tubing near the patient.

The Lack system is another variation of the Mapleson-A system, in which the relief valve is located adjacent to the fresh gas entry point, improving convenience and scavenging connections. Originally presented as a coaxial circuit, the design has undergone further modifications. It is now available in both coaxial and parallel versions. The performance is similar to that of the Magill system. Walsh and Taylor (2004) compared a miniature parallel Lack circuit to a Jackson-Reese modified Mapleson-F circuit for use in cats, and found the miniature Lack circuit to be more efficient, requiring a markedly lower fresh gas flow to prevent rebreathing. The Lack circuit is popular in the United Kingdom and elsewhere, but appears to be unavailable in the United States.

2. Mapleson-D Circuits

Both coaxial and parallel forms of the circuit are available (Fig. 5-17D). The coaxial version, or Bain circuit, is perhaps the most common configuration used in research institutions. In this version, fresh gas enters at the end of the circuit distal from the patient and is conducted to the patient end by a small-diameter tube contained within the large-diameter exhalation limb. The parallel circuit is similar, except that the fresh gas supply tube is outside the exhalation limb, entering the circuit near the patient connection. The circuit can be used by attaching a bag with a pressure relief valve and scavenger connection to the distal end, resulting in a somewhat cumbersome assembly. It is much more convenient to use a Mapleson-D control arm, or universal control arm (Fig. 5-18). The control arm incorporates a



Fig. 5-18 Mapleson-D or Bain Adaptor. The circuit manometer, APL valve, circuit connection, and reservoir bag mount are arranged counterclockwise from the top in this photograph. The slotted chromed cap covers a mounting port for an optional ventilator/bag selector valve.



Fig. 5-19 Modified Mapleson-D Arm. In this photo, the Mapleson-D arm has been modified by the addition of a positive end expiratory pressure (PEEP) valve located below and between the APL valve and the circuit manometer. The PEEP valve provides an adjustable safety pressure release to the system. Credit: Courtesy of David S. Hodgson, D.V.M., DACVA.

manometer, an APL valve and scavenging port, and a mount for the reservoir bag. With Mapleson-D control arms, the problem of inadvertent barotrauma due to a failure to open the APL valve after delivering a breath has been addressed by McMurphy et al. (1995). They describe the addition of an adjustable positive end expiratory pressure (PEEP) valve to the control arm to limit attainable circuit pressure (Fig. 5-19).

Functionally, coaxial and parallel systems have similar performance. In terms of the fresh gas flow needed to limit rebreathing, Mapleson-D circuits are less efficient than Mapleson-A circuits during spontaneous breathing. During assisted or controlled ventilation, it is generally considered that moderate fresh gas flows in conjunction with adequate minute ventilation will avoid hypercarbia (Davey, 2005b; Dorsch and Dorsch, 1999f; Lerche et al., 2000b). Fresh gas flows of 100–130 cm³/kg/min, with a minimum flow of 0.5 lpm, have been recommended for small animals, although higher flows may be needed in patients with increased carbon dioxide production (Hartsfield, 1996a; Manley and McDonell, 1979).

3. Mapleson-E Circuits

Mapleson-E circuits (Fig. 5-17E) perform much like Mapleson-D circuits, but lack a reservoir bag. The expiratory end of the circuit is open or, if inhalant anesthesia is used, connected to a scavenging interface. Without a reservoir bag, the circuit is not well suited to assisted ventilation. Some rodent anesthesia machines use a parallel or coaxial Mapleson-D circuit, omitting the reservoir bag and APL valve. In this form, it is a Mapleson-E circuit. Several masks using active scavenging have been proposed for use in rodents, and are described in Section VII.



Fig. 5-20 Jackson-Rees Circuit. Bickford Nonbreathing System. The patient connection with fresh gas inlet and corrugated hose are at the top of photo. The hose is connected to reservoir bag, seen below the hose and patient connection. Waste gas exits the bag at the side using a rubber membrane to enclose the exit path. Normally, the path is open, but when the membrane is pressed, it seals the exit port and permits single-handed ventilation. Additional connectors and adaptors are seen at the bottom. Credit: Courtesy of A.M. Bickford, Inc.

4. Mapleson-F Circuits

The Ayre's T-tube (Fig. 5-17F) is the classic example but, in its simplest form, is seldom used for inhalation anesthesia. The Jackson-Rees modification is commonly used. The modified circuit is similar to the Mapleson-E, but a reservoir bag is added with provisions for scavenging at the bag tail (Fig. 5-20), besides an adjustable pressure relief valve. Darma and Pua (2000) describe a modification of the Jackson-Rees circuit to avoid occlusion of the circuit caused by twisting at the reservoir bag connections and the addition of a lightweight APL valve.

V. ANESTHETIC MACHINES

A. Introduction

This section covers examples of anesthetic machines, common or likely to become common in research facilities, that clearly illustrate the major features of the class to which they belong. A full description of many specialized rodent anesthesia machines, and of older and current veterinary and human anesthesia machines is beyond the scope of this chapter. For similar reasons, large animal veterinary machines are not described. Readers interested in a more thorough discussion of these topics should consult the current and older editions of the texts listed in "Additional Reading."

B. Rodent Anesthesia Machines

In addition to the machines described below, three variant designs are discussed in Sections VI.B–D (Ventilators), and VII. (Induction Chambers and Masks), based either on the use of an integrated ventilator or on the use of coaxial scavenging masks.

1. Single Circuit Designs

It is possible to satisfactorily induce and maintain anesthesia in rodents and other small animals using virtually any machine equipped with a nonbreathing circuit. However, the term “rodent anesthesia machine” is usually understood to mean an anesthesia machine lacking all the components of a circle system, and intended for use with a Mapleson-E circuit, or functionally similar design, without a reservoir bag or APL valve. Additional features, such as multiple breathing circuits and provision for one or more induction chambers, are common.

In the simplest form, a delivery system adequate for many rodent procedures consists of little more than a flowmeter, a vaporizer, a breathing circuit and mask, and some means of scavenging waste gas. A means of delivering and controlling the pressure of fresh gas, either a central supply system or a tank and pressure regulator, is also needed. Without a frame to arrange the components and to maintain the flowmeter and vaporizer upright and immobile when the controls are operated, such a “machine” will be inconvenient to use. Many small rodent machines are commercially available, usually equipped with gas supply connections to meet the user’s needs, and often with an oxygen flush valve. The oxygen flush valve is intended to flush the induction chamber, in order to reduce pollution when the chamber is opened. For reasons previously discussed, the oxygen flush valve should never be used when an animal is connected to a nonbreathing circuit. In these smaller machines, the fresh gas supply to the breathing circuit(s) is frequently, but not always, connected directly to the vaporizer outlet. An example of a small machine is seen in Fig. 5-21.

Inhalation anesthesia is often used for both induction and maintenance of laboratory rodents. The output of the vaporizer is frequently split in order to allow the use of an induction chamber as well as a breathing circuit, eliminating the need to disconnect one in order to use the other. Some machines use a Y-connection attached to the vaporizer output port and a two-way valve to divert the flow to the chamber or vaporizer leg, as desired, with a similar arrangement for the mask and chamber scavenging lines. Machines of this type are often adequate for laboratory or central facility use when only a few animals are to undergo a procedure or when the procedures are relatively long. Because of their simplicity and easily accessible components, further modifications for use with other equipment, such as ventilators, are usually straightforward.



Fig. 5-21 Summit Portable Anesthesia Machine. The flowmeter, oxygen flush valve, and a Tec 3 vaporizer are arranged left to right on the frame, with a carrying handle projecting over the vaporizer. Silicone tubing is used for the vaporizer connections. Credit: Courtesy of Molecular Imaging Products.

2. Multicircuit Designs

a. Variable-area Flowmeters

Many rodent procedures are relatively brief and must be performed on groups of animals in a short time period, so multiple patient circuits are frequently needed. With the exception of a few machines, it is assumed that all of the patients can be adequately and safely anesthetized using the same fresh gas flow and agent concentration. Several approaches are used to divide the vaporizer output.

A simple, but cumbersome, method is to subdivide the flow from the vaporizer using a sufficient number of sequential Y-connectors and tubing runs to form the needed number of patient circuits. Typically, tubing and connectors with an internal diameter of about 6.4 mm (0.25 inches) or somewhat greater are used. Simple on/off valves can be used to open or close individual patient circuits. The resistance to flow is directly proportional to the length and inversely proportional to the diameter of the tubing and connectors. For every patient to receive the same fresh gas flow, each leg of the assembly, measured from the vaporizer outlet to the patient mask, should be of equal length. The fresh gas flow to the vaporizer must be adjusted to take into account the number of open circuits. If, for example, six circuits are in use and the desired flow to each is 0.5 lpm, the total flow would be 3.0 lpm. As the procedures are completed, if five of the circuits are closed without proportionately decreasing the total flow, the remaining animal would receive 3.0 lpm, an excessively high flow that might impede breathing. Leaving an unoccupied circuit open avoids the need to adjust the flowmeter, but further contributes to pollution with anesthetic gas and hence

is not an acceptable practice. Each patient circuit also requires appropriate scavenging connections, which ordinarily requires wide-diameter tubing, 19 mm inner diameter (ID) or greater, to avoid back pressure, resistance to breathing, and leakage at the patient mask. Several commercial machines using this basic system are available. Alternatively, this type of multicircuit design is easily assembled on site. However, as more circuits are added, the proliferation of tubing, connectors, and valves becomes difficult to keep track of, and promotes operator error.

Multicircuit rodent machines are available that provide adjustable flowmeters to control the flow rate to each breathing circuit. One such design is the Summit Anesthesia Solutions™ Multiplex Delivery System (Bend, OR). In this arrangement, the individual flowmeters are placed downstream of the vaporizer output, to separately control the flow to each mask. The total fresh gas to the vaporizer must be sufficient to allow further division of the vaporizer output for each individual patient circuit. Once this condition is met, individual circuits may be controlled by their respective flowmeters without further adjustment of the master flowmeter. An overpressure relief valve or a secondary low-pressure regulator is used to prevent excessive pressure and damage to the vaporizer and master flowmeter should the circuit flowmeters be turned off without turning off the master flowmeter. A version of this machine is available that uses flow restrictors, discussed below, instead of variable-area flowmeters.

With all current multicircuit rodent anesthesia machines, the concentration of the anesthetic agent is set at the vaporizer and is the same for all patients. An exception is the SurgiVet™ Multi-Station (Fig. 5-22), which supports up to six patient circuits and allows the anesthetic agent concentration to be independently adjusted for each circuit. This is accomplished by selecting the desired flow and anesthetic concentration at the master flowmeter and vaporizer, respectively. Fresh gas flow from the vaporizer is equally divided between the patient stations in use, so that the flow set at the master flowmeter is the sum of the desired flows to each of the stations in use. To meet the linearity specifications for the vaporizer, a minimum total flow of 0.5 lpm on the master flowmeter is necessary. Each patient station has a secondary, or auxiliary oxygen flowmeter, which can be used to dilute the fresh gas flow from the vaporizer to a lower agent concentration determined by the user. Thus, in this design, the maximum agent concentration is set at the vaporizer, but lower concentrations can be obtained at each station, at the discretion of the operator. The fresh gas connection to the coaxial circuits is located beneath the auxiliary flowmeters, using tubing to connect to the fresh gas inlet of the coaxial breathing circuit. Nineteen millimeter scavenging tubing is used to connect the expiratory end of the circuits to the scavenging interface, which may be purchased from the vendor or provided locally.

b. Flow Restrictors

A relatively new class of rodent anesthesia machines uses flow restrictors in place of variable-area flowmeters. These machines

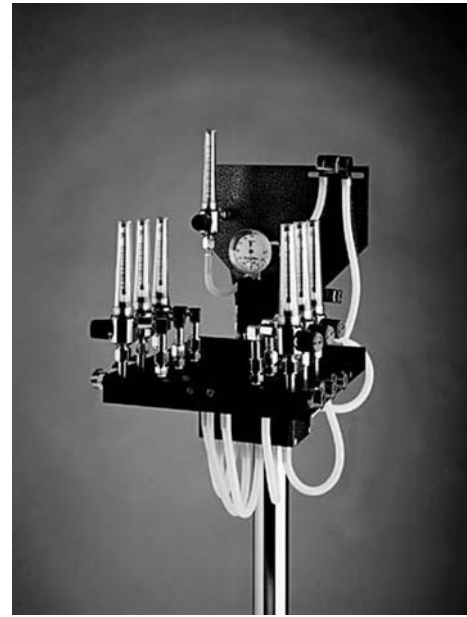

Fig. 5-22 SurgiVet Multi-Station Anesthesia Machine. The master flowmeter is seen at the top left. No vaporizer is mounted, but the vaporizer connections are at the top right. Six independent oxygen flowmeters are mounted below and in front of the master flowmeter, each controlling a connection to a Mapleson-D circuit (CPRAM). The fresh gas supply for each circuit is connected to the polished metal fitting on the base immediately below the corresponding flowmeter. Credit: Courtesy of Smiths Medical PM, Inc.

offer multiple patient circuits controlled by simple pneumatic switches; the circuit is either on or off. The fresh gas flow rate is typically on the order of 0.5 lpm for each circuit. An internal pressure regulator is used to maintain a constant pressure, which varies little with the number of circuits in use, so that a constant fixed flow is generated in the circuit. In operation, the user selects the agent concentration on the vaporizer, and turns on the requisite number of circuits as needed. In addition to the Summit Anesthesia Solutions Multiplex Delivery System described above, a series of distinct machines made by VetEquip™ (Pleasanton, CA) use flow restrictors to simplify the workflow. Various models are offered, some with integrated induction chambers and scavenging provisions. In each case, the vaporizer is customized to operate at the internal pressure used in the machine and is not interchangeable with other Tec 3 vaporizers. The Compac5, seen in Fig. 5-23, has five circuits, including three chambers for induction or recovery, and two coaxial circuits for anesthesia maintenance. The flow to the induction chambers is set at 1 lpm, and to the breathing circuits at 0.5 lpm. The scavenging connections are on the machine. A fan-driven scavenging system directs the waste gas to the disposal interface.

C. Veterinary Machines

Small animal veterinary machines are familiar to most readers. While compact versions are the most common, larger

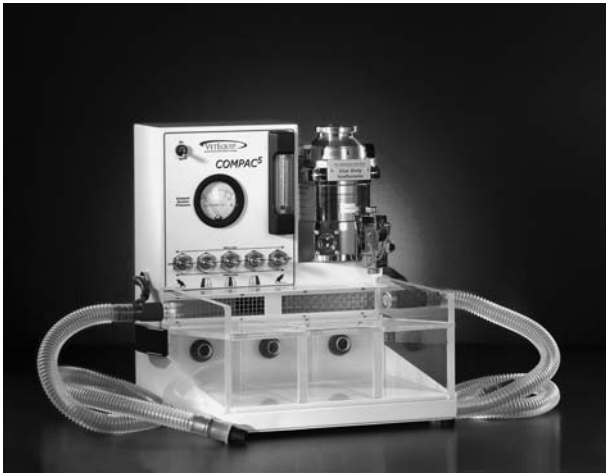

Fig. 5-23 VetEquip Compac5. Two coaxial breathing circuits are seen on each side of the machine. A customized Tec 3 vaporizer is at the right. The control panel has five switches to independently control each of the breathing circuits and the three heated induction chambers. The large gauge indicates scavenging exhaust system pressure. Credit: Courtesy of VetEquip, Inc.

console or cabinet models, as well as wall-mounted versions, are also available. A generic description of a representative machine might include a pole stand, absorber assembly, unidirectional valves, APL valve, oxygen flush valve, breathing system manometer, and a mounting points for one, or possibly two, vaporizers and flowmeters. The details of design and assembly vary widely among manufacturers. In some machines, the flowmeter(s), vaporizer, APL valve and other components are arranged on the stand and connected by flexible or rigid tubing. Other designs use a manifold block that also serves as a mounting base for the circle breathing system components, usually including the unidirectional valves, absorber assembly, oxygen flush valve, and breathing system manometer. Five-point caster bases are common on smaller machines, but for greater stability, some manufacturers use an H configuration, similar to larger machines. Machines equipped only for nonrebreathing circuits are also available. Almost all manufacturers will equip their machines with yoke assemblies and large tank or central gas services, to meet the needs of the purchaser. A small “monitor shelf” is often present as well, although the available space may be minimal. One example of a compact machine is the Matrix VMS (Fig. 5-24). Larger models often include mounting points for at least two vaporizers, three flowmeters, and a larger and more stable stand, with one or more shelves, and drawers, as seen in the Disposed Optimax Elite (Fig. 5-25).

Pole-mounted or compact machines are often chosen for anesthesia induction and preoperative preparation areas because of their mobility and small footprint. Wall-mounted versions may provide an additional option for areas where space is at a premium. In surgical suits, larger machines offer greater convenience in terms of additional workspace, monitor shelves, and storage for frequently used accessories and supplies.



Fig. 5-24 Matrix VMS. This anesthesia machine is a pole-mounted compact machine. The APL valve is seen on the left mounted on the expiratory valve. The fitting on the right, atop the inspiratory valve, is a negative pressure relief valve or air intake valve, used to entrain room air if the oxygen supply fails. The breathing system manometer is placed on the absorber system. The vaporizer, not shown, is mounted below the absorber assembly. Credit: Courtesy of Matrix by Midmark.

Compared with human anesthesia machines, veterinary machines are smaller, easier to move, and considerably less complex. They are also less expensive to purchase and maintain. However, in more demanding circumstances, these advantages may be offset by their limited breathing gas choices, safety features and alarms, lack of integrated ventilators and monitors, and lack of additional storage space characteristic of human machines.

D. Human Anesthesia Machines and Workstations

The recent trend toward building electronically controlled machines with integrated monitors, ventilators, and safety systems has resulted in a new class of anesthesia machines, often called anesthesia workstations. At the same time modern, but simpler, anesthesia machines are being produced for use in locations and specialties that do not require sophisticated workstations. Simple or advanced, the cost of new human



Fig. 5-25 Dipomed Optimax Elite. This model has a large workspace, a monitor shelf, and mounts for three flowmeters. Lockout mounts for two vaporizers are located to the right of the flowmeters. To the left, on the angled panel below the flowmeter assembly, is a breathing system manometer adjacent to two pipeline pressure gauges. The unidirectional valves are mounted on the workspace in front of the breathing system manometer. Breathing circuit connections and the oxygen flush valve are mounted on the face of the workspace and the absorber assembly is mounted below, as are two drawers in the base. Credit: Courtesy of Dipomed Ltd.



Fig. 5-26 North American Dräger 2A. The large work and storage space, multiple flowmeters, central supply and small tank pressure gauges, mounts for three vaporizers, and dual canister absorber system, are typical for machines of this series. Adjustable alarms for the breathing circuit are also common. Credit: Courtesy of DREVeterinary (www.dreveterinary.com).

anesthesia machines usually exceeds the budget of research facilities. Even so, human machines are used and frequently obtained either by donation or purchase of used equipment.

Human anesthesia machines, produced in the last generation before the development of workstations, are often used in research. They are larger than their veterinary counterparts, and are usually more robustly constructed, to withstand heavy hospital workloads. In most cases, human anesthesia machines have larger workspaces, with monitor shelves and storage capacity. Multiple flowmeters are the rule, including dual tube oxygen flowmeters, as well as nitrous oxide, an oxygen proportioning system and, often, medical air. In most cases, two or more vaporizers can be used with a lockout mechanism. Pressure gauges for small tank yoke assemblies and often for the central gas supply system, are located below the flowmeter block. In anticipation of a higher surgical caseload and lengthy procedures, dual canister absorber systems are frequently used. Many of these machines also include a mounting point for a nonbreathing system adapter. Most have mechanical ventilators, made by or for the machine manufacturer. A ventilator selector switch

may be included, to facilitate changing from spontaneous or manually assisted ventilation to mechanical ventilation. Alarm warning of fresh gas supply failure, high breathing circuit pressure, and ventilator function are also common. Most or all of these features are present on the North American Dräger 2A (Fig. 5-26), and the Ohmeda Excel 210 (Fig. 5-27), and many other machines of this generation. Although fitted with more convenience and safety features than typical veterinary machines, with some training and experience they are relatively easy to understand and use. Anesthetic machines of this type can be satisfactorily used for a wide range of research animals. New human anesthesia machines, usually intended for use in outpatient surgery, diagnostic and specialty procedural areas, are available with similar, but updated, features.

The most sophisticated anesthetic machines available are found in the current generation of anesthesia workstations. They are designed to consolidate many of the functions performed by the anesthetist into a single, integrated machine. Ventilators, fresh gas composition and flow, and patient physiological information are all monitored and controlled through the extensive

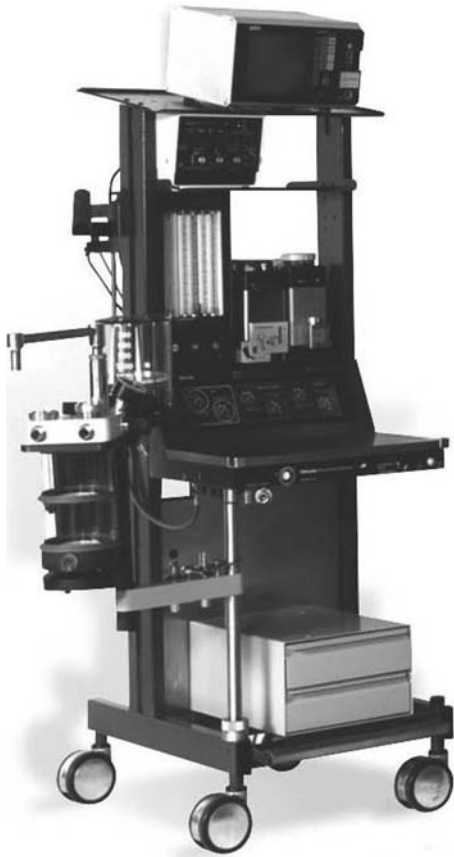

Fig. 5-27 Ohmeda Excel 210. Roughly contemporary with the Drager machine in Fig. 5-25, the features of this machine are similar. In this photograph, a multifunctional monitor is placed on the monitor shelf. Credit: Courtesy of DREVeterinary (www.dreveterinary.com).

use of microprocessors. Flat panel displays and touch-controlled screens allow the anesthetist to operate the machine and arrange and display critical patient and machine status information. A tiered system of alarms, warnings, and advisories is used to keep the operator aware of patient and machine status. The use of increasingly sophisticated ventilators has led to extensive modification of the breathing system, with additional gas pathways and valves. Most of the familiar working components of the machine are concealed from the user, and the complexity of these machines is belied by a deceptively simple appearance. Except for emergency oxygen, anesthesia workstations are dependent upon a steady power supply, and are often equipped with backup batteries. When the machine is turned on, it conducts a series of self-tests and checks, including prompts for needed corrective actions by the operator. Extensive training and familiarization is needed to operate workstations, and the procedures vary with each new model. Workstations require regular maintenance and service by a trained technician.

It seems unlikely that most research facilities need, or could afford to own an anesthetic workstation. Despite that, these machines provide a glimpse of the future.

E. Used Anesthesia Machines

Hospital and institutional storage facilities often accumulate older anesthesia equipment, removed from service as newer machines are acquired. For philanthropic reasons, or in an effort to create space and recoup expenses, used machines are sometimes donated, or offered for sale. Often, components and operating manuals are missing, and the condition of the equipment is uncertain, despite claims to the contrary. The same degree of caution and skepticism employed in buying a used car should be applied. At the least, a qualified service technician should inspect the machine and assure the potential owner that it is fully functional or can be economically restored to full function.

The age of the machine is an issue. Machines long out of production may lack essential safety features and employ nonstandard fittings and controls that result in operator error. Further, it becomes increasingly difficult to find repair parts for these machines. More recent equipment is often still in use in smaller hospitals, and is frequently reconditioned and sold to less affluent markets worldwide. Service and repair parts are more likely to remain available. Newer, and more complex machines, such as workstations are correspondingly more expensive to maintain, require greater training to use, and are not clearly superior in terms of patient outcome.

There is a robust market for used anesthesia equipment. In many cases, purchasing reconditioned equipment from a reputable company, willing to guarantee the machine and to provide service for it, is a safer and more economical alternative to getting a “free” machine that does not work as designed and cannot be repaired.

F. Maintenance and Testing

Maintenance of anesthetic machines is essential to assure safety and performance. Some aspects of anesthesia machine component maintenance are addressed in Section III of this chapter. While the operator’s manual is usually the best source for information concerning user maintenance, cleanliness is a universal recommendation. Operating rooms are not a friendly environment for anesthesia machines. Many cleaning agents, intravenous fluids, and disinfectants attack metal surfaces, especially on prolonged contact. Dust and hair accumulate on all exposed surfaces; if allowed to infiltrate the control mechanisms of flowmeters, vaporizers, and APL valves, debris can cause premature failure. Stands, frame components and especially casters also profit from regular cleaning.

The anesthesia machine should be tested before use. The recommended steps vary with the machine and type of circuits to be used. Anesthesia equipment texts contain extensive descriptions of checkout procedures. The sources listed in “Additional Reading” and the recommendations of the machine manufacturer should be used to develop a standard check procedure for

each anesthesia machine. With consistent use, the procedures can be accomplished in a reasonably short time and are an essential method of assuring patient and personnel safety. A few basic elements of checkout procedures are described below. Modification of the procedures may be needed for specific machines (Dorsch and Dorsch, 1999g).

The machine should be inspected to assure that breathing gas oxygen supplies are adequate, properly connected, and functioning. The flowmeters are turned on and off, while observing the float. It should move smoothly as the flow is increased, and decreased, and should indicate zero flow in the off position.

With no fresh gas flow, the vaporizer is checked for adequate fill level, ensuring that the filling port is closed and that the vaporizer is turned off. The low-pressure circuits are now checked using a suction bulb fitted with a valve and tubing terminating with a 15 mm connector to the common gas outlet. The bulb is compressed until it is empty, and observed for 10 seconds. If the bulb remains empty, the low-pressure circuitry is not significantly leaking. Again, with no gas flowing, the vaporizer is turned on and the test is repeated to check for leaks in the vaporizer. For machines with multiple vaporizers, each is tested in turn. The fresh gas hose is reconnected to the fresh gas outlet.

The patient breathing circuit and reservoir bag are connected and the APL valve is closed. The patient connector is occluded by hand or, more conveniently, an appropriately sized rubber stopper. Using the flowmeters or oxygen flush valve, the bag is filled to a pressure of 30–40 cm H₂O on the breathing system manometer. The pressure should not drop over a 10 second period (Dorsch and Dorsch, 1990g). Mason (1993) describes a similar test, but specifies a drop of less than 5 cm H₂O over a 30 second period. The pressure is released using the APL valve, allowing assessment of the valve and preventing dust from the absorber being forced into the breathing circuit by sudden decompression. If a universal control arm is used, the Mapleson circuits can be similarly assessed. However, coaxial versions of these systems, such as Bain circuits, must also be tested to assure that the inner fresh tube has not become disconnected. A disposable syringe plunger is used to occlude the inner fresh gas tube while the fresh gas is flowing. Suggested flow rates vary from 0.05 lpm (Mason, 1993) to 2 lpm (Dorsch and Dorsch, 1999g). When the fresh gas supply tube is occluded, the flowmeter indicator should fall. Disconnection of the fresh gas tube can convert the entire circuit into apparatus dead space.

VI. VENTILATORS

A. Introduction

Mechanical ventilators are used to free the anesthetist from the task of manually assisting ventilation. While ventilators used during anesthesia are ordinarily simpler than those used for

long-term respiratory support or intensive care, the differences are less clear in ventilators on new human anesthesia machines. In terms of both physiology and technology, the subject of mechanical ventilation is complex. Readers unfamiliar with the subject should consult anesthesia and respiratory therapy texts for thorough discussions. For veterinary and some older human ventilators, Hartsfield (1996b) provides a well-illustrated and detailed description of many human and veterinary ventilators that may be encountered in research facilities. The following is a greatly simplified overview of the terminology and technology used in mechanical ventilation. There are substantial differences in ventilator designs; a careful reading of the operating manual for the ventilator is essential to understand the controls, abilities, and limitations of each specific model. Consultation with a veterinary or human anesthesiologist, as well as the equipment manufacturer is often invaluable.

It is useful to define a few of the terms used in describing ventilator functions and controls before discussing individual examples. The *minute volume* is the total amount of gas delivered to the patient in 1 minute. The *tidal volume* is the amount delivered in a single breath. Thus, minute volume equals the tidal volume multiplied by the *respiratory rate*. The *inspiratory flow rate* is rate at which the gas enters the airways and is, in effect, the speed at which a tidal volume is delivered. The *inspiratory flow phase* is the time from the beginning of inspiratory flow to the beginning to expiratory flow, including an inspiratory pause, if present. The period from the end of the inspiratory flow phase until the beginning to the next inspiratory flow phase is the *expiratory phase time*. The inspiratory–expiratory phase time ratio, or *I:E ratio*, is fixed at about 1:2 on some ventilators, but can be altered on others. Because these variables are interrelated, they may be set directly or indirectly, using a combination of controls, and vary with the design of the ventilator.

Maximum inspiratory pressure, or maximum working pressure, is the highest pressure that can be generated during the breathing cycle and can be preset by the user on some ventilators. When the maximum inspiratory pressure is reached, inspiratory flow stops, regardless of other settings.

Compliance describes the unit change in volume per unit change in pressure. Thus, a patient with high compliance will have a greater increase in lung volume at the same airway pressure than a patient with low compliance. Animals with thin chest walls, such as rabbits, may be over distended and suffer lung damage at pressures safe, or even necessary, for a larger and less compliant patient, such as a pig. Patients are not the only source of compliance; equipment compliance due to distensible circuits and other machine components can reduce the volume the patient receives from the ventilator. Although this is not ordinarily a problem with large tidal volumes, it should be taken into account when small tidal volumes are used.

Positive end expiratory pressure (PEEP) maintains a controlled minimum pressure in the airways at the end of expiration, preventing complete collapse of the small airways during mechanical ventilation. A discussion of the indications for using

PEEP is beyond the scope of this chapter, but it is mentioned because many newer human anesthesia machines have an integrated PEEP valve. PEEP can also be applied by interposing a PEEP valve in the expiratory limb of the breathing circuit, usually attached to the expiratory unidirectional valve. Reusable PEEP valves are sold individually or in sets including a range of pressures indicated in centimeters of water.

The basic ventilation mode for most anesthesia ventilators is *intermittent positive pressure ventilation* (IPPV). The ventilator delivers a breath at the frequency determined directly or indirectly by the control settings, and exhalation is passive. However, the patient can also breathe independently of the ventilator. The inspiratory phase can be terminated based on time, pressure, volume, or flow rate. Most anesthesia ventilators are time cycled, and most have a control to limit the maximum working pressure. The mode of ventilation refers to the breathing pattern, usually based on delivered volume or pressure. New anesthesia ventilators may offer the user a choice of ventilation modes. For example, the ventilator may be able to monitor spontaneous breathing and match it to deliver a desired tidal volume. A number of different ventilation modes are used and are described differently by different manufacturers (Davey, 2005c; Banner and Lampotang, 1992).

Ventilators suitable for use with magnetic resonance imaging (MRI) equipment are available in models suitable for patients ranging in size from adult humans to mice.

Positive pressure anesthesia ventilators require a source of compressed gas. A bellows, piston, or valves directly controlling the high-pressure gas are used to direct the tidal volume to the patient. In the following section, they are referred to as bellows, piston, and pneumatic ventilators, although the latter description is not strictly accurate.

B. Bellows Ventilators

The most common design for an anesthesia ventilator uses bellows housed in a transparent housing. The bellows is intermittently compressed by high-pressure gas admitted into the surrounding housing. This design, which separates the drive gas in the housing from the breathing gas in the bellows, is called dual circuit. The tidal volume can be controlled by limiting the excursion of the bellows with a mechanical stop; in that case the bellows is completely emptied with each breath. Alternatively, the tidal volume may be determined by precisely limiting the volume of drive gas entering the housing. Because the bellows is emptied proportionately to the amount of drive gas entering the housing, the bellows may not be completely emptied. A ventilator exhaust valve releases the drive gas in the housing during exhalation.

The pressure generated in the breathing circuit is primarily a function of the volume of gas delivered by the bellows. However, the fresh gas flow can also affect delivered pressure and volume. In new ventilators, this is addressed by fresh gas decoupling,

which prevents the interaction between the ventilator, oxygen flush valve, and fresh gas flow. Excess gas in the patient circuit is exhausted by a relief valve, or spill valve, after the bellows is refilled. A spill valve is needed because, in most cases, the APL valve is closed or isolated from the breathing circuit during mechanical ventilation. Tidal volume, peak inspiratory pressure and rate are adjusted to achieve the desired ventilation pattern. In many ventilators, a maximum working pressure can be set as a safety measure. It is usually set somewhat above the peak inspiratory pressure determined by the user settings. The breathing system manometer indicates pressure in the breathing system.

If the bellows rises upon expiration, it is called a standing or ascending bellows; if it falls, it is called a hanging or descending bellows. Standing bellows are used in most new ventilators, but both types remain in use. The standing bellows is thought to provide an advantage because a leak or disconnection in the breathing circuit is visually obvious; the bellows will not refill and return to its normal starting position. A hanging bellows is weighted and may return to the start position and appear to be working normally despite a leak or disconnection. For many ventilators, interchangeable pediatric bellows assemblies are available. An example of a standing bellows is seen in Fig. 5-28. The ventilator is a Hallowell 2002IE veterinary ventilator; it may be mounted on the anesthesia machine or on a separate stand. It is a time-cycled minute-volume divider, with controls

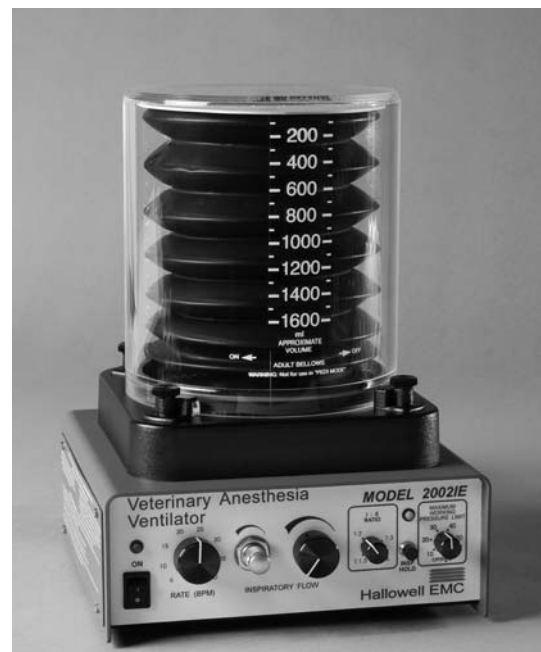

Fig. 5-28 Standing Bellows. The controls for this standing bellows anesthesia ventilator include, from left to right, the power switch, respiratory rate adjustment, fine and coarse inspiratory flow, adjustable I:E ratio, and the maximum working pressure control. Interchangeable bellows and housings can accommodate tidal volumes up to 3,000 ml. Credit: Hallowell EMC.

for fine and coarse inspiratory flow, respiration rate, maximum working pressure limit, and I:E ratio. The product of inspiratory flow, labeled “Volume” on the control panel, and rate determines minute volume. If only the breathing rate is changed, without altering the inspiratory flow, the tidal volume will increase or decrease accordingly to maintain the minute volume. In order to change minute volume, the inspiratory flow must be changed. Several sizes of interchangeable bellows are available to meet the needs of a wide variety of patients.

A hanging bellows is seen in Fig. 5-29, used with an older North American Dräger AV-E ventilator. A mechanical stop, or footplate, is used to set tidal volume indicated on the housing. In addition to tidal volume, the ventilator has controls to directly set inspiratory flow and respiratory rate. I:E ratios can be set incrementally from 1:1 to 1:4.5. Newer models also have an adjustable maximum pressure limit control.

If the ventilator is integrated into the anesthesia machine, a selector switch is used to isolate the APL valve and reservoir bag and open a connection between the ventilator and the breathing circuit. Otherwise, the APL valve is closed, and the reservoir bag is removed and replaced with the ventilator hose. Alarms are usually present to indicate low pressure, when a disconnection

occurs in the patient circuit, and high pressure, when the maximum working pressure is reached or exceeded. A variety of other ventilator and circuit status alarms may also be present, depending upon the age and model of ventilator and anesthesia machine. MRI-compatible ventilators are available in sizes suitable for a range of species from humans to mice.

An unusual hybrid of anesthesia machine and ventilator is the Hallowell Veterinary Anesthesia Workstation (Fig. 5-30). Intended for use with rats and larger animals with up to a 200 ml tidal volume, the ventilator replaces the bellows with a light graphite “puck” contained in a clear housing, and includes a complete miniature circle system with unidirectional valves and carbon dioxide absorber. The breathing system chamber is heated to maintain warmth and humidity in the circuit. The ventilator controls include tidal volume, respiratory rate, and adjustable maximum working pressure. With the exception of an additional flowmeter for the anesthetic vaporizer, the ventilator is essentially a miniature anesthesia machine which requires a compressed oxygen source and has connections for the vaporizer and waste gas scavenging.



Fig. 5-29 Hanging Bellows. In this design, the bellows is forced upwards to deliver a breath. A mechanical stop is used to adjust the tidal volume, and a weight returns the bellows to the starting position during exhalation.



Fig. 5-30 Hallowell EMC Anesthesia Workstation. At the base of the ventilator from left to right, are the controls for power, tidal volume, and respiratory rate. The controls at the right include a standby switch and alarms. Airway pressure is indicated by an illuminated bar display at the top right, and the maximum working pressure is set using the adjacent dial. The oxygen flowmeter is seen below. The clear housing encloses the “bellows” seen to the left, and the absorbent canister and unidirectional valves, seen to the right. Credit: Courtesy of Hallowell EMC.

C. Piston Ventilators

Piston ventilators use an electrically driven piston to deliver a preset volume to the breathing circuit. The volume is determined by the diameter of the cylinder and the stroke of the piston. In many models, interchangeable cylinder assemblies are available to provide a range of tidal volumes. The stroke is controlled either by electronic or, more typically a mechanical linkage to alter the swept volume of the cylinder. In most current designs, the stroke can be altered while the ventilator is working. In all but the oldest piston ventilators, a control varies motor speed to select the rate. In some cases, the I:E ratio can be altered. Piston ventilators are available in sizes to accommodate animals ranging from dogs to neonatal mice. Until recently, piston ventilators were not used in clinical anesthesia machines, but an extremely sophisticated, microprocessor-controlled piston ventilator is now integrated into new Dräger anesthesia workstations.

A valve system is used to direct the fresh gas first to the cylinder, then to the animal, and finally to an exhaust port. Relatively noncompliant tubing is used to minimize volume loss in the patient tubing. Piston ventilators were originally designed to use room air at ambient pressure, but anesthetic gas mixtures can often be used. The connection to the anesthetic gas supply usually requires a reservoir at ambient pressure for the ventilator to draw upon, and scavenging provisions for waste gas. If gas is delivered under pressure directly to the cylinder intake, the delivered volume will be higher than indicated. The ventilator manufacturer should always be consulted for advice regarding the suitability and the connections needed for anesthetic gases.

The selection of tidal volume is usually based upon the patient weight, taken from a nomogram or chart, or derived from experience. The assumption is that all patients are typical or normal. In piston ventilators, all of the tidal volume is delivered to the patient regardless of the airway pressure. With no provisions for setting a maximum working pressure, and often in the absence of an airway manometer, the potential for barotrauma is real. It is simple to insert a manometer, or other pressure sensor, into the breathing circuit which can help to prevent, or at least diagnose, the problem. Conversely, if an oral endotracheal tube is used in rodents, the lack of a cuff will result in a variable amount of leakage around the tube. In this case, the selected tidal volume represents the total of the desired tidal volume and the additional volume needed to compensate for the leak, which may account for some of the diverse ventilator settings reported in the literature.

An example of a piston ventilator is the Harvard Apparatus 683 Small Animal Ventilator (Fig. 5-31). This ventilator uses interchangeable pistons to provide a range of tidal volumes. The dials control tidal volume and rate, and there is a digital rate display.

Piston ventilators are generally rugged and reliable, but they do require maintenance. Cleaning and proper lubrication are essential for proper performance, as is replacement of worn



Fig. 5-31 Harvard 683 Small Animal Ventilator. This type of ventilator is commonly used for rodents and, in larger models, for many other research animals. Respiratory rate and tidal volume are set using the two dials seen to the right. Respiratory rate is indicated in the digital screen at the top right. The breathing circuit and fresh gas connections are housed in the valve tower seen at the lower right, with the waste gas connection on the opposite (top right) side of the valve tower. The piston assembly is to the lower left side of the valve tower. Credit: Courtesy of Harvard Apparatus.

components. The recommendations provided by the ventilator maker should be followed if the ventilator is to perform as designed.

D. Pneumatic Ventilators

If the gas delivery pressure is known, a selected volume of gas can be delivered by timing the opening and closing of a valve controlling the inspiratory flow. Alternatively, the pressure in the breathing circuit can be measured and the inspiratory valve closed at a predetermined pressure setting. Both of these means are used to regulate tidal volumes in some of the ventilators previously described. Rodent ventilators are available which allow for volume- or pressure-limited modes using valves connected directly to the patient breathing circuit. An example is the CWE SAR-830/P, seen in Fig. 5-32. The ventilator may be set to cycle in pressure or volume mode. The controls on this model include inspiratory time, respiratory rate, fresh gas flow rate, and an adjustable maximum working pressure limit. The respiratory rate is set directly, as is the flow rate. Tidal volume is indirectly determined using the inspiratory time control and the flow rate. The I:E ratio can be determined by altering the inspiratory time and adjusting the flow rate using the flowmeter to maintain a constant tidal volume. A switch is used to select volume or pressure mode. In the pressure mode, the adjustable maximum working pressure limit control stops inspiration when the set pressure limit is reached. The respiration rate is displayed on a screen on the front of the ventilator. A "hold" switch is used to manually control a sigh. The ventilator can be used with current



Fig. 5-32 CWE SAR-830/P Ventilator. From the top left, the display for ventilation rate, the rate control, the inspiratory time control, and a circuit pressure display are seen. The fresh gas flowmeter is at the far right. The second tier of controls and indicators include the power switch, adjustable maximum working pressure limit, a volume/pressure mode selector switch, an inspiratory hold control, and cycle mode indicators lights. The bottom tier includes pump and breathing circuit connections. Credit: Courtesy of CWE, Inc.

inhalation anesthetics, and an MRI-compatible volume-cycled model is available.

E. Jet Ventilation and High-Frequency Ventilation

Briefly, a jet ventilator is a small-diameter tube inserted into the trachea through which oxygen is supplied at relatively high pressures. The technique, also called transtracheal ventilation, is used in situations where an endotracheal tube cannot be used and a tracheotomy is not desired, such as some head and neck procedures, during bronchoscopy, or in emergencies when an airway cannot be secured. In a situation where the patient cannot be intubated and cannot be ventilated by mask, a catheter is inserted percutaneously into the trachea and connected to the common gas outlet of the anesthesia machine using a Luer-lock for the catheter and a 15 mm endotracheal tube adaptor for the common gas outlet. The techniques and equipment are described by Benumof et al. (1992) and Davey (2005c).

High-frequency ventilation is characterized by very high respiration rates and very small tidal volumes. The technique is used to maintain perfusion and oxygenation in a collapsed lung during surgery, or to ventilate patients with some types of lung disease. It may also be used with jet ventilation. High-frequency positive-pressure ventilation is possible with some current anesthesia ventilators, and special ventilators are made for high-frequency jet ventilation. High-frequency oscillatory ventilation uses a constant gas flow to establish the mean airway pressure and imposes very high-frequency oscillations by means of what is essentially a loudspeaker. The mechanisms of gas exchange are complex, and well beyond the scope of

this chapter. High-frequency oscillatory ventilators are occasionally used in human critical care settings, but one model, the Hallowell MicroVent1, is marketed for use in rodents and some larger species. The ventilator can operate in either intermittent positive-pressure or high-frequency mode, and connections are provided for a vaporizer. During high-frequency oscillatory ventilation, normal respiratory excursions cease and only a slight vibration is seen. While initially disconcerting, the lack of gross movement may be an advantage in some surgical procedures.

VII. INDUCTION CHAMBERS AND MASKS

A. Induction Chambers

Induction chambers are used as a means to induce anesthesia and avoid manual restraint. They are among the most common methods used to induce anesthesia in rodents, but are also used for aggressive or fearful larger animals. With suitable precautions, a liquid volatile anesthetic agent can be placed directly in the chamber as described in Chapter 3, but usually the chamber is simply connected to an anesthetic machine. Almost every imaginable type of container has been used, including shoe-box cages, plastic bags, food storage containers, aquariums, chemical desiccators, and various jars, cans, and beakers. The chamber should allow enough space for the animal to assume a normal extended position as anesthesia is induced. A chamber may appear to be adequate for a conscious animal, but might result in anatomical distortion and airway compromise as consciousness is lost.

Colorless, transparent chambers are preferred because they permit the anesthetist to observe the animal during induction. Most commercially available chambers are plastic and meet these requirements. In facilities with access to a shop, custom plastic induction chambers are easily fabricated. However, inhalation agents are powerful solvents, and aggressively attack most plastics. If a liquid agent is used, contact with the plastic chamber should be avoided by placing it in a secondary container. With time, even chambers used only with an anesthetic machine may begin to develop small surface cracks, or crazing. The lid should fit tightly enough to prevent leaking and to foil escape attempts; many commercial designs use a gasket and locking mechanism to ensure a tight seal.

While the chamber inlet diameter may vary, the diameter of the outlet should accommodate 19–30 mm tubing without significant restriction, in order to avoid resistance to flow and increased pressure in the chamber.

Connection to an anesthetic machine provides the ability to introduce oxygen and control the concentration of the anesthetic agent. The location of entry and exit ports for the gas vary widely, but in a study of carbon dioxide euthanasia Golledge (2006) reported that introducing the fresh gas at the top of the chamber ensured better mixing.

There is a relationship between the chamber volume and the fresh gas flow needed to achieve an anesthetic level in a given time. Using the time constant, tau, it is simple to predict the time needed to reach the desired anesthetic concentration in a chamber. Equation 5-1 is a simplified version an exponential function used to describe "... a change in which the rate of change of the variable is proportional to the magnitude of the variable or inversely proportional to magnitude of the variable" (Healy et al., 1991).

$$\text{(Eq. 5-1)} \quad \tau = \frac{\text{Volume (liters)}}{\text{Flow (liters per minute)}}$$

The time constant, tau, is expressed in minutes. To reach 95% of the concentration set on the vaporizer requires three time constants. The remaining 5% is negligible and well within the accuracy limits of vaporizers. At a fresh gas flow of 1 lpm into a 2 liter chamber, tau is 2 minutes and 3 tau is 6 minutes. In this example, doubling the fresh gas to 2 liters, halves the required time, and illustrates a convenient relationship. If the fresh gas flow and the chamber volume are equivalent, 3 minutes are needed to reach the concentration set on the vaporizer. Because the calculations do not take into account the volume of the patient, the required time may be somewhat less. Thus, within the constraints mentioned previously, chambers should be no larger than necessary.

It is also obvious that very large chambers will require considerably more time, oxygen, and anesthetic agent. Anesthesia flowmeters do not ordinarily exceed 10 lpm, and vaporizer output tends to drop off at high flows, so attempting to match the flow to the chamber volume is unrealistic in larger chambers. If very large induction chambers must be used, an alternative is to introduce liquid agent in a volume calculated to reach the desired level. A convenient device intended for this purpose is the Vapor Wand (Fig. 5-33). The design and use of the delivery system is described by Hodgson (2007).



Fig. 5-33 Vapor Wand. A calculated amount of liquid volatile anesthetic is drawn into the syringe and delivered into the induction chamber via the perforated steel tube. Credit: Courtesy of David S. Hodgson, D.V.M., DACVA.



Fig. 5-34 VetEquip 2 l Vented Chamber. The sliding, inclined lid is seen at the left, opening into the chamber. A hood partially enclosing the evacuation connection is visible at the upper right. Anesthetic gases are introduced through a port located beneath the evacuation port in the wall of the chamber. As the lid is opened, the evacuation flow entrains gas from the chamber, conducting it away from the work area via a fan-driven high flow evacuation system. Credit: Courtesy of VetEquip, Inc.

Anesthesia induction chambers are major sources of pollution with waste gas, discussed elsewhere in this text. Actively scavenged chambers for rodents have become available (Fig. 5-34). These chambers require very high exhaust flows in order to work as designed. Flows of this magnitude can be generated by fan-driven blower systems, such as those used with ventilated cage racks or similar arrangements, but cannot be attained with conventional central vacuum systems.

B. Face Masks

Face masks are used to provide oxygen and to deliver anesthetic breathing mixtures. They are used for induction and maintenance of anesthesia for short procedures, and when endotracheal intubation is not possible or desirable. Face masks are also the most common means of maintaining inhalational anesthesia in rodents. To work efficiently and safely, a conventional mask must have a tight seal to the patient and minimal dead space (Smith and Bolon, 2006). A seal is usually attained with a gasket or a fenestrated diaphragm, which must be replaced when damaged or deteriorated. Dead space depends on the degree to which the mask conforms to the anatomy of the patient, a notable difficulty given the range of species used in research.

Face masks, or nosecones, used in small animal clinical practice are, with some exceptions, useful for dogs, cats, and species of similar size and conformation. The larger sizes are also suitable for domestic swine. Masks intended for use with human pediatric and neonatal patients are sometimes useful for nonhuman primates. For small animals, masks are often connected to

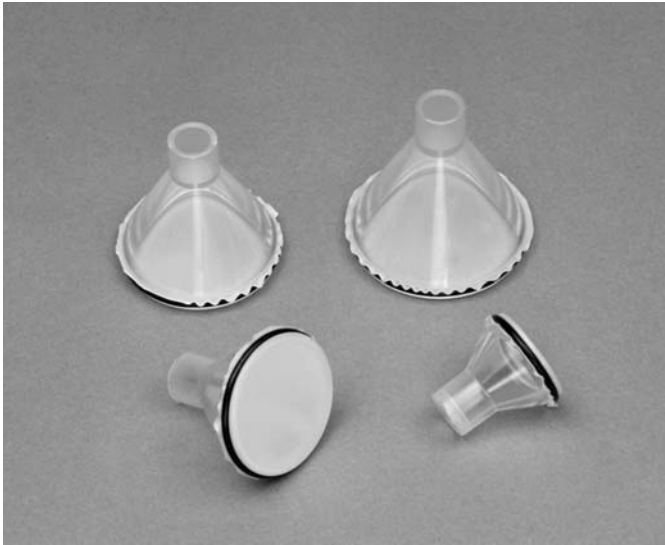

Fig. 5-35 Rodent Face Masks. These small masks have an easily replaceable diaphragm. The user cuts the mask opening to the desired size. Credit: Courtesy of Molecular Imaging Products.

a Mapleson-D circuit; for larger animals a circle system usually is used.

For some species, it may be necessary to fabricate a mask from available containers, such as plastic bottles or jugs, using sufficient padding to achieve a close, comfortable fit with minimal dead space. Achieving a durable tight connection to the breathing circuit is usually difficult, but can be accomplished with the help of good selection of spare connectors and some ingenuity.

A variety of masks is available for rodents, with or without diaphragms. Some are sold as separate components, with a 15 mm connector breathing circuit connector. Other masks have connections for Mapleson-E adaptors. Examples of both types are seen in Figs 5-35 and 5-36. As for larger animals, designs using a diaphragm are preferred because the cross-sectional anatomy of the nose and mouth is rarely circular and a diaphragm provides a more reliable seal (Smith and Bolon, 2006).

As an expedient, a simple syringe case and a cotton pledget, wetted with liquid volatile agent, can be used for rodents, but some means of exhausting the resulting waste gas without recirculation is necessary. The control of anesthesia depends on close observation, regulating the depth of anesthesia by changing the position of the animal's head in the mask to alter the mixture of air and agent. Anesthetic agent consumption is high compared to using a vaporizer, oxygen is not provided during anesthesia, and close observation of the patient competes with procedural demands.

Coaxial, actively scavenged masks for rodents have been described by several authors (Glen et al., 1980; Henry and Casto, 1989; Hunter et al., 1984; Levy et al., 1980; Li et al., 2001; McGarrick and Thexton, 1979). These masks do not use a

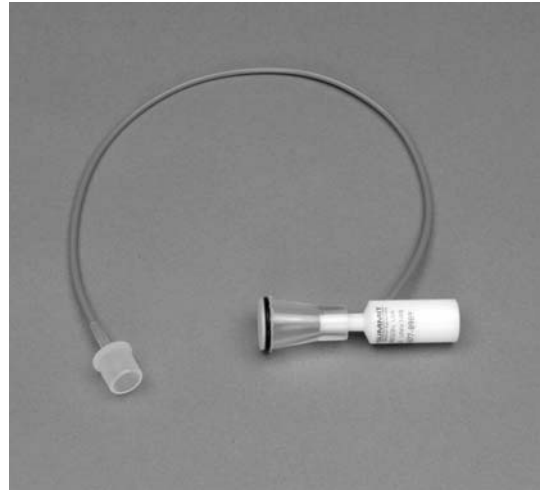

Fig. 5-36 Universal Nosecone Nonbreathing System. The small fresh gas tube enters near the mask connection using a 15 mm adaptor to connect to the anesthetic vaporizer. Nineteen mm scavenging tubing is attached to the end opposite the mask adaptor and serves as a reservoir tube and waste gas conduit to the disposal site. Credit: Courtesy of Molecular Imaging Products.

diaphragm. The animal's head is placed in the inner tube, which is connected to the fresh gas outlet of the anesthesia machine. The inner tube is surrounded by a larger outer tube connected to a suction source. Hunter et al. (1984) emphasize that adequate scavenging requires that the inner tube not extend beyond the outer scavenging tube. The scavenging flow is generated by an exhaust fan or by connection to a vacuum line. In either case, the scavenging flow needed is high in comparison with fresh gas flow. The animal's nose must remain in the inner tube of the mask, but as no diaphragm is used, the mask is less sensitive to minor movement than conventional designs. With adequate exhaust flows, the SurgiVet Multi-Station can be used in this fashion. The Fluovac™ Gas Scavenger (Fig. 5-37) described by Hunter et al. (1984) uses the same concept, as does the Multistation Rodent Anesthesia Delivery and Scavenging System (Fig. 5-38), distributed by BioTex™ (Houston). The Fluovac has two delivery circuits and employs a fan-driven scavenging system to draw the waste gas through a large activated carbon canister. It is connected to the fresh gas outlet of the anesthesia machine or to a compressed gas source using a flowmeter and vaporizer. The BioTex machine is a compact design with two nosecones and provision for an induction chamber. It also employs a fan to produce exhaust flow at the masks and to direct the waste gas to a scavenging interface. The machine was designed for induction and maintenance of anesthesia prior to transferring the animal to another maintenance system during imaging studies.

Masks are available for use with stereotaxic stands. The mask is usually mounted on the incisor bar, replacing the nose clamp (Fig. 5-39). Connections are provided to pass a constant flow of gas across the mask which functions like a T-tube. Various sizes and configurations are available from suppliers of stereotaxic



Fig. 5-37 Fluovac Gas Scavenger. The two coaxial patient circuits originate at the top and end in actively scavenged coaxial masks. Waste gas is drawn through the large charcoal canister by a fan housed in the base. Connections to fresh gas are at the rear of the unit. Credit: Courtesy of Stoelting Co.

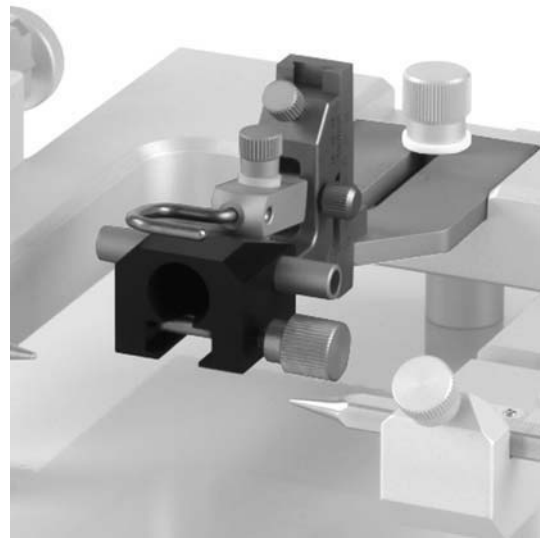

Fig. 5-39 Mouse Gas Anesthesia Mask Stoelting. The mask is seen mounted on a stereotaxic frame. In this design, the nose clamp is used to secure the mask over the incisor bar. The two tubes on either side of the mask are connected to the fresh gas source and scavenging interface, respectively. Credit: Courtesy of Stoelting Co.



Fig. 5-38 Multistation Rodent Anesthesia Delivery and Scavenging System. This compact machine is shown with a vaporizer at the top of the case. Two coaxial delivery cones are at the bottom corners. An induction chamber is seen at the right and the waste gas transfer hose at the top right, near the vaporizer. Credit: Courtesy of BioTex.

equipment, including models with special restraint devices for use with neonatal rodents.

VIII. INJECTABLE ANESTHETIC DELIVERY SYSTEMS

Syringe pumps, or drivers, are used for controlled infusion of anesthetics, analgesics, or other high-potency drugs.

Simple fixed-rate syringe drivers can be used for this purpose, but they place a considerable demand on the user to calculate and prepare drug dilutions and to closely monitor their operation. Instead, variable-rate, microprocessor-controlled syringe pumps are preferred. Such pumps are available from human and some veterinary medical suppliers as well as vendors of scientific equipment for biomedical research. For anesthesia use, the pump software should recognize the volume and concentration units used for drugs, and display infusion rates based on the selected units. The ability to deliver a user programmable bolus of drug is essential, as are alarms to warn of delivery line occlusion and an impending empty syringe. A display screen should indicate the infusion rate in appropriate units, the delivered and remaining volume, and the operating status of the pump. Pumps having these features are usually intended and labeled for use in anesthesia.

There is an increasing interest in human and veterinary medicine in total intravenous anesthesia (TIVA) and analgesia, although in many cases, inhalation agents are used concurrently. For human use, control algorithms have been developed based on the known pharmacodynamic and pharmacokinetic properties of some widely used intravenous anesthetic agents. These target-controlled infusion schemes are computer controlled to vary the rate of administration over time, producing a more stable plane of anesthesia (Diba, 2005b). For animals, the information needed is not available for many species, nor is the market sufficiently great to support development of the requisite control algorithms. The features and controls of anesthesia syringe pumps change with each new model and often with

software updates. Those unfamiliar with these devices should research currently available models and seek advice from colleagues experienced in their use before purchasing them. For intravenous anesthesia, modern syringe pumps are the equivalent to a precision vaporizer, with more complex user controls. Used equipment should be purchased with the same precautions discussed for used anesthesia machines.

IX. EQUIPMENT FOR AIRWAY ACCESS AND CONTROL

A. Laryngoscopes

In anesthesia, laryngoscopes are used to visualize the laryngeal opening during endotracheal intubation. In addition to conventional instruments, flexible fiberoptic laryngoscopes, and endoscopes with or without video displays are also used. Equipment used for airway access in rodents is based on methods and designs similar to those used for larger animals.

1. Conventional Laryngoscopes

The classic instrument consists of a cylindrical handle housing one or more batteries with a connection for a detachable blade. A standard hook-on connection is used, and with some exceptions, the blades are interchangeable among handles. Handles are available in several styles, ranging from small penlight styles to heavy, stubby handles designed for use in humans with limited oral access. Small handles are convenient for small blades, which tend to be overbalanced on larger handles. For the same reason, larger blades are more easily controlled when an appropriately large handle is used. Handles are relatively inexpensive compared to laryngoscope blades. Reusable handles are available for conventional blades, with a light bulb mounted on the blade, and for blades employing fiberoptic bundles. For fiberoptic blades, the light is usually located in the handle. A green stripe is used to indicate a fiberoptic handle, with a corresponding green marking on the blade. In this system, handles and blades from different manufacturers are interchangeable.

For both handles and blades, specifications for replacement lamps vary with the manufacturer, and are not reliably interchangeable among brands. With prolonged use, the hook on connection of the laryngoscope handle is subject to wear and becomes unreliable in holding the blade and in maintaining the electrical connection to the light. In most cases, replacement is less expensive than repair. Disposable plastic laryngoscopes are available in blade styles and lengths commonly used in humans. A disposable laryngoscope may be preferred when sterilization of the intubation equipment is essential, as with use in biohazard facilities.

Blades for laryngoscopes are usually made of chrome-plated brass, stainless steel, or plastic. A bewildering array of specialty

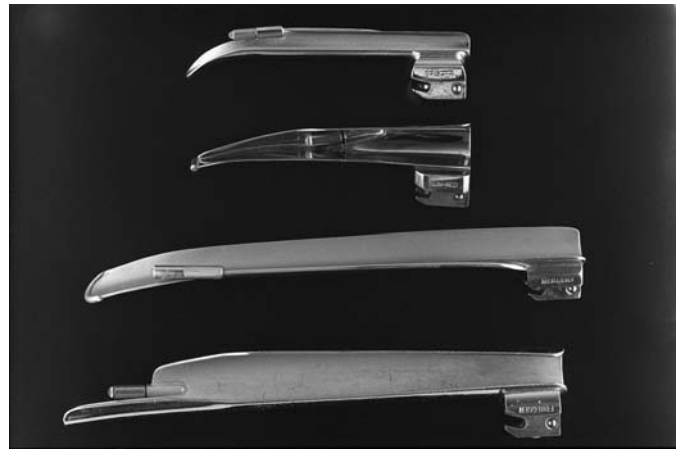

Fig. 5-40 Straight Laryngoscope Blades. From top to bottom, Phillips, Robertshaw, modified Miller, and Wisconsin blades are shown. The Miller blade has been modified by removing the flange and placing the light on the right side.

blades is available, designed for specific applications in human anesthesia and critical care. A much more limited selection of blades is available for use in larger veterinary patients, including domestic swine and small ruminants. Laryngoscope blades are typically divided into straight or curved styles, each style requiring a somewhat different technique in use. Typical straight blades include the Miller and Wisconsin patterns (Fig. 5-40). Smaller Phillips and Robertshaw blades, sometimes used in smaller patients, are also shown. While straight blades are frequently preferred by veterinary clinicians, curved blades have significant advantages in some cases. The Macintosh blade (Fig. 5-41) is one of the most popular blades used for humans, and works equally well in many nonhuman primates and other species with similar oral anatomy. On many laryngoscope blades, a flange is used to control and deflect the tongue. However, for use in patients with a restricted mouth opening, and for many veterinary applications, blades in which the flange



Fig. 5-41 Curved Laryngoscope Blades. A Macintosh blade is seen at the top, and a Choi double-angle blade at the bottom. Note the absence of a flange on the Choi blade.

is reduced or absent are preferred. The Wisconsin, Robertshaw, and Macintosh blades seen in Figs 5-40 and 5-41 are flanged. The flange is reduced or absent in the Miller, Phillips, and Choi blades depicted in the same figures. For some blades, either version may be purchased. Alternatively, a flange can sometimes be removed from an otherwise satisfactory design. For some designs, laryngoscope blades are available equipped with a port to supply oxygen during intubation, a useful feature for critically ill patients, or when a difficult and prolonged intubation is anticipated.

A limited number of human blades are available with a reversed light position. When the blade is held with the hook-on connector facing up, the light is ordinarily on the left side. For left-handed human anesthetists, and for right-handed veterinarians whose patients are in sternal recumbency, the light is more conveniently placed on the right of the blade.

Curved blades are designed to lift the epiglottis indirectly, by advancing the tip into the vallecula, the depression formed at the base of the tongue and epiglottis. Gently depressing the base of the tongue with the blade, in combination with slight retraction, will further lower the epiglottis and improve the view of the laryngeal opening. This technique avoids the potential for damaging the epiglottis by direct contact and pressure. Straight blades can be placed over the epiglottis, to depress it directly, but may also be used in the same manner as a curved blade.

Although the laryngoscope is deceptively simple in appearance, facility in its use is an acquired skill, requiring training and practice. Intubation of animals such as cats and dogs can be accomplished relatively easily without a laryngoscope. In other species, including swine, small ruminants and often, nonhuman primates, a laryngoscope is essential for rapid and minimally traumatic intubation. A firm practical knowledge of airway anatomy, careful preparation of the patient and equipment, attention to patient positioning, and gentle technique are required for consistent minimally traumatic intubation.

2. Flexible Fiberoptic Laryngoscopes

Although similar to flexible fiberoptic endoscopes, flexible fiberoptic laryngoscopes are adapted to the needs of the anesthetist. They are used when airway access is anticipated to be difficult or complicated by anatomical or pathological conditions. These devices are usually configured for direct viewing by the operator via a lens or small screen. A working channel is incorporated into the fiberoptic bundle for suction or injection, as needed. The fiberoptic bundle can be controlled by the operator. They can be used in a variety of ways, but often, the endotracheal tube is placed over the fiberoptic bundle, which is directed into the trachea. The endotracheal tube is then advanced, using the fiberoptic bundle as a guide. The fiberoptic bundles are somewhat delicate and should be handled with care, especially to protect the bundle from being bitten by the patient. Other small diagnostic endoscopes can be used similarly. The techniques for using these instruments to assist

intubation differ from those needed for conventional laryngoscope blades; training and experience are needed for consistent success.

3. Intubation Equipment for Rodents

Methods and equipment for endotracheal intubation of mice and rats have been described by numerous authors, largely since 1970. Most of the methods were originally described for rats, and have since been adapted to mice. With few exceptions, they are similar to methods that have been used in human medicine. Reported methods and equipment include blind intubation using rigid stylets (Jaffe and Free, 1973; Stark et al., 1981). Special mouth gags (Gross, 1958; Jou et al., 2000), and modified or custom-made laryngoscopes (Costa et al., 1986; Hey and Pleuvry, 1973; Linden et al., 2000; Medd and Heywood, 1970; Morgan, 1982; Proctor and Fernando, 1973; Schaefer et al., 1984; Tran and Lawson, 1986; Weksler et al., 1994) have often been advocated. Also reported are methods using direct lighting with or without mouth gags (Alpert et al., 1982; Boersma and Wieringa, 1982; Hranicka et al., 1977; Pena and Cabrera, 1980; Thet, 1983). For rats, the use of transillumination was described by Yasaki and Dyck (1991), Cambron et al. (1995) and again by Rivard et al. (2006). Clary et al. (2003) reported use of an arthroscope and video camera for intubation of rats. The design of a modified illuminated laryngoscope blade for rats was described by Molthen (2006). The use of an inclined stand was reported by Cambron et al. (1995), and again by Lizio et al. (2001), Kastl et al. (2004), and Theodorsson et al. (2005). Intubation guides or guide wires were used by Weksler et al. (1994), Linden et al. (2000), and Kastl et al. (2004). Brown et al. (1999) described an inclined stand and the use of transillumination for mice, as did Bivas-Benmita et al. (2005). Rivera et al. (2005) described an inclined stand and the use of a fiberoptic stylet, or guide, for intubation of mice and rats.

In summary, the methods involve blind intubation, intubation using direct light, and intubation using indirect light. Blind intubation is feasible, but difficult to learn and prone to result in trauma in inexperienced hands. Direct illumination alone, or in combination with laryngoscopes, lighted stylets, or mouth gags is a common approach to endotracheal intubation in rodents. These methods vary in their equipment requirements, and the ease with which they can be learned varies with the educational background and experience of the operator. Transillumination is simple in terms of equipment, and relatively easy to perform, but positioning the light to gain the best view is sometimes difficult. Rigid stylets, or guides, are problematic and likely to cause trauma if not used with care. Flexible intubation guides, such as guide wires, avoid the problem of the endotracheal tube blocking the view as the laryngeal entrance is approached, and are less likely to cause trauma than rigid stylets. However, their flexibility can make them more difficult to control. Positioning aids, such as intubation stands, make the process much more comfortable for the user but, because most depend upon intact



Fig. 5-42 Hallowell Rodent WorkStand. The stand is seen tilted to the 45° angle used during intubation. The adjustable lateral positioning aides are in the center, rotated to accommodate mice. The holes at the base and the depressions at the top are for a tube of 1/8 inch umbilical tape, used to secure the endotracheal tube in rats, and lidocaine gel used for mice, respectively. Credit: Courtesy of Hallowell EMC.

upper incisors, they cannot be used in animals with abnormal dentition. There are no perfect methods.

Two systems are available commercially. The Hallowell EMC Rodent WorkStand and other components incorporate elements of the techniques described by Weksler et al. (1994), Cambron (1995), and Tran and Lawson (1986) among others. The procedure is very similar to that used with a conventional laryngoscope and intubation guide. The intubation work stand is seen in Fig. 5-42. It can be rotated from a level position to a 45° angle and has adjustable lateral stabilizers used to help maintain the correct position for intubation. The stabilizers are reversible for use with mice or rats. The endotracheal tube is mounted on the guide wire/syringe assembly seen in Fig. 5-43. A molded otoscope speculum (Fig. 5-44), modified after Tran and Lawson (1986), acts as a miniature laryngoscope blade. It is used with a standard otoscope equipped with an operating head, to provide illumination and magnification. Specula are available in

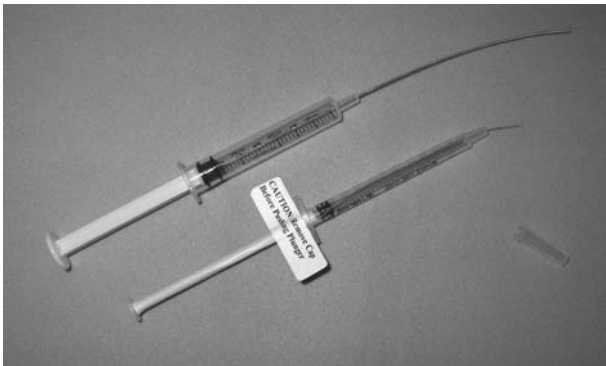

Fig. 5-43 Intubation Guides. The guide wires are attached to the syringe plunger. The top guide wire is used for rats and animals of similar size. The lower guide wire is used for mice. Credit: Courtesy of Hallowell EMC.



Fig. 5-44 Rat Intubation Speculum. The intubation speculum is similar to that described by Tran and Lawson (1986) and is molded of hard, autoclavable plastic for use with an operating head otoscope. Credit: Courtesy of Hallowell EMC.

two sizes for rats and mice. The anesthetized animal is placed supine on the level stand, and the upper incisors are secured using a rounded rubber loop affixed to hook and loop tape. The tape is then secured to a corresponding strip on the underside of the stand. The stand is rotated to a 45° angle and the operator uses a cotton swab, or the shaft of the swab for smaller rodents, to roll the tongue out of the mouth and to elevate the mandible. The speculum is inserted and advanced until a clear view of the epiglottis and vocal cords is obtained. Following application of lidocaine, the intubation guide wire is introduced from the side of the mouth using the slot in the speculum and, under direct vision, is advanced a short distance into the trachea. The endotracheal tube is then advanced over the guide wire. The endotracheal tube is held in place and the guide wire is immediately withdrawn. Intubation is confirmed by observing fogging of the tube, or a mirror, or by brief occlusion of the tube while observing the alteration in thoracic respiratory movements. The stand and the intubation specula are autoclavable.

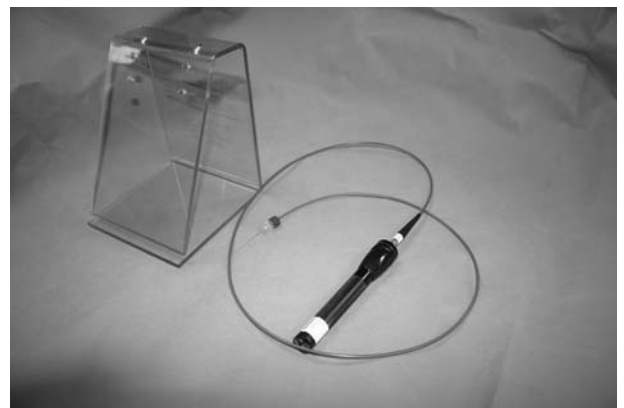

Fig. 5-45 BioLITE System. The fixed 60° angled stand is seen to the left. Three sets of holes, two on the front and an additional set on the level top of the stand, correspond to pegs holding the incisor wire. The illuminated flexible optical fiber intubation stylet and light source are seen at the right. An adjustable Luer fitting is used to secure the tube during intubation. Credit: Courtesy of BioTex.

The BioLITE system (Fig. 5-45) uses a modified flashlight in which the lens and reflector assembly have been replaced with a specially designed optical assembly. With this system, the intubation procedure is similar to that used in larger animals and humans with a flexible lighted stylet under direct vision. The light guide is equipped with an adjustable Luer-lock to secure the endotracheal tube during intubation. The position of the endotracheal tube is adjusted to allow the end of the optical fiber to extend slightly beyond the end of the tube, acting as an illuminated guide. The intubation stand has a fixed 60° angle, with three mounting positions to adjust the animal to a convenient height. The anesthetized mouse or rat is placed supine on the stand and secured using an incisor wire to hold the upper incisors. Lidocaine may be applied with a swab to further desensitize the larynx. The tongue is retracted and the fiberoptic illuminated stylet and attached endotracheal tube is advanced under direct vision into the trachea. The endotracheal tube is held in place, and the stylet is immediately removed. Intubation is confirmed using brief manual occlusion of the tube, as previously described, or by a lung inflation bulb. In the latter case, a small bulb attached to a male Luer fitting is inserted into the corresponding female fitting of the endotracheal tube. As the bulb is squeezed, the thorax is observed to confirm synchronous motion. Unitary construction of the stand facilitates cleaning and disinfection. Three sizes of fiberoptic stylets are available for mice, small rats, and larger rats.

B. Endotracheal Tubes

Endotracheal tubes reduce anatomical dead space, secure the airway, and facilitate assisted or mechanical ventilation. For animals in which human endotracheal tubes can be used, an enormous selection is possible though, in practice, only a few types are commonly used. Laryngeal mask airways are not, strictly speaking, endotracheal tubes but are included here. For rodents, intravenous catheters or small gauge laboratory tubing are usually used.

1. *Conventional Endotracheal Tubes*

Endotracheal tubes designed for human use have a standard 15-mm connector to the breathing circuit. The tubes are marked in millimeters with their internal diameter and in centimeters for their length. Smaller tubes are also marked with the outer diameter (OD) in millimeters. Most endotracheal tubes have a preformed curve. The curve increases visualization of the laryngeal opening when intubation is performed using a conventional laryngoscope, and may reduce pressure on the tracheal wall once the tube is in place. The distal end is beveled, and may have a small opening opposite the bevel called a Murphy eye, intended to provide an additional path for gas if the bevel is occluded. A radiopaque marker is often present, to help with the radiographic assessment of the tube position.

The tubes most commonly encountered are made of polyvinyl chloride (PVC), but polyurethane, silicone rubber, and red rubber tubes are also available. In general, PVC tubes are less expensive and suitable for most uses. They are lighter than silicone or red rubber tubes, transparent, and offer a good balance of wall thickness to internal diameter. While PVC tubes are somewhat rigid at room temperature, they soften as they warm to body temperature. Polyurethane tubes are softer than PVC tubes, but offer many of the same advantages, although at a higher price. Silicone tubes are soft and are translucent rather than transparent. They are thick walled in comparison with PVC tubes. However, silicone tubes are relatively resistant to kinking, and can be autoclaved. The use of red rubber tubes has decreased because they are opaque, subject to deterioration, and are allergenic for those with latex allergies.

Endotracheal tubes may be cuffed or uncuffed. A cuff is used to seal the tube to prevent leakage of anesthetic gases and during positive pressure ventilation, and to prevent aspiration of oral secretions or gastric contents. Cuffed tubes have a channel leading from the cuff to an inflation line and pilot balloon. Cuffs can be described in terms of the pressure needed to inflate them, or their volume at any given pressure, or both. Low-volume, high-pressure cuffs require a higher inflation pressure, and provide a narrow seal at the tracheal wall. High-volume, low-pressure cuffs have a greater area of tracheal contact, but may require less pressure to attain it. Frequently, the balloon has a short extension terminating in a one-way valve fitted with a female Luer connection. If a one-way valve is not present, or is incompetent, a three-way stopcock is often used, to provide for easy inflation and adjustment.

The amount of air needed to adequately inflate the cuff depends on the diameter of the trachea and the endotracheal tube, as well as the type of cuff. While the size of the tube is known, tracheal diameter can vary during anesthesia, as the trachea relaxes. Cuff pressure can change during anesthesia and should be periodically reassessed. Gradual increases in cuff pressure often accompany the use of nitrous oxide, as it equilibrates with the gas in the cuff. By contrast, silicone is especially permeable to gases, and may slowly lose pressure during extended anesthesia. For this reason, when silicone endotracheal tubes are used, it has been suggested that the cuff be filled with saline, rather than air (Harper, 2007).

Excessive cuff pressure can impede blood flow to the tracheal mucosa. The resulting damage becomes apparent in the postanesthesia period, ranging from transient partial airway obstruction and dyspnea to persistent severe airway stricture. Cuff pressure needs only to be sufficient to minimize leakage during manual or mechanical ventilation, and to limit aspiration of oral secretions or gastric contents. However, inadequate cuff pressure obviates the advantage of having a cuff at all. Especially with high-volume low-pressure cuffs, palpating the pilot balloon to determine cuff pressure is insensitive and unreliable (Hoffman et al., 2006). With these cuffs, pressure is best measured using a cuff manometer made for the purpose (Fig. 5-46).



Fig. 5-46 Cuff Manometer. For low-pressure high-volume cuffs, a cuff manometer is used to inflate the endotracheal tube cuff and simultaneously measure the inflation pressure. Credit: Courtesy of Moses Goddard, M.D.

The manometer will not work with high-pressure low-volume designs because the pressure needed to expand the cuff to any degree is considerable and does not indicate contact with the tracheal wall. A less convenient, but effective alternative is to use the breathing circuit manometer to establish a minimal leak; the cuff is slowly inflated until a barely perceptible leak is established at the desired pressure. Because the cuff pressure needed to prevent leakage depends to a large degree on peak airway pressure, large patients generally require a higher pressure than do small patients, for which lower ventilation pressures are commonly used. Devices to limit cuff pressure, such as the Lanz[®] endotracheal tube, are available at increased cost, and have been shown in dogs to maintain a constant cuff pressure and to limit tracheal mucosal damage (Abud et al., 2005). Low-volume, high-pressure cuffs are usually somewhat easier to insert than high-volume, low-pressure cuffs, but may be somewhat more prone to cause tracheal damage.

In general, the largest endotracheal tube that can be inserted *without trauma* should be used. The interior diameter of the tube is usually the greatest constriction in the pathway between the patient's lungs and the breathing system, and resistance to flow is determined more by the diameter of the tube than by its length. For this, and other reasons, uncuffed tubes have often been advocated for smaller animals, such as rabbits, cats, and ferrets. Cuffed tubes can safely be used in these animals provided sufficient care is taken to monitor cuff pressure. However, the length of the tube extending beyond the patient's mouth does add to equipment dead space, and may contribute significantly to rebreathing in small patients; tubes should be cut to fit.

For small patients, when a cuffed tube cannot be used, uncuffed tubes are available in very small sizes for human neonates. In the event that even these are too large, Cole tubes can be used. These tubes have relatively short intratracheal segment, sharply reduced in diameter from the body to the tube. They are intended to seal at the narrowest diameter of



Fig. 5-47 Conventional Cole Tube. Notice the reduced distal end, wider intraoral segment and standard connector.



Fig. 5-48 T-Wall Cole Tube. The longer intratracheal span and metal tape reinforcement in the intratracheal portion (George: there is a missing word or words here) can be seen. Credit: Courtesy of Vital Signs, Inc.

the upper airway, not to be wedged against the larynx. Two types are available. The first (Fig. 5-47) is a conventional PVC tube. The second tube (Fig. 5-48), is a polyurethane tube in which the distal, intratracheal portion is reinforced with a spiral of shape-memory alloy tape that resists deformation. The T-Wall[™] endotracheal tube has a relatively thin wall and a longer intratracheal segment. It provides a larger ID compared to conventional Cole tubes of the same OD. As with conventional Cole tubes, the extra-tracheal portion of the tube can be trimmed to reduce equipment dead space. It is available in tubes with OD's of 3.6, 4.3, and 4.9 mm.

Spiral wire or nylon reinforced tubes are useful where there is a particular risk of kinking the endotracheal tube, when the head and neck must be sharply flexed. The spiral reinforcement may run the entire length of the tube, or may be only in the intratracheal segment, as with the T-Wall tube. Full-length wire reinforced tubes are difficult to trim.

The correct placement of the endotracheal tube should always be confirmed. Condensation on the tube can be deceiving because it can also occur with esophageal placement. Excursions of the reservoir bag in synchrony with respiration can

occur with esophageal intubation, albeit usually in smaller magnitude than with intratracheal placement. Auscultation of the lungs and stomach while briskly compressing the reservoir bag to deliver short small breaths is more certain and simple, requiring only a stethoscope. Observation of a normal capnographic waveform is usually considered the most reliable means of confirming proper placement.

Many modified and specialty endotracheal tubes are available for nasal intubation, endobronchial intubation, laser surgery, respiratory gas sampling, and other special applications. They are well described, illustrated, and discussed in current anesthesia equipment texts, and in numerous published papers (Dorsch and Dorsch, 1999h).

Endotracheal tube connectors are usually supplied with the tubes, and are usually hard plastic. With the exception of tubes sold for large domestic animals, such as cattle and horses, the connection is a standard 15 mm taper. Metal connectors are available, as well as connectors made from polysulfone for use with autoclavable tubes. Connectors are sized according to the endotracheal tube ID. For very small patients, low-dead space connectors are especially useful (Fig. 5-49). The smallest sizes will fit the Luer connection of an intravenous catheter, frequently used as an endotracheal tube in rodents. Low-dead space connectors may be incompatible with some coaxial nonrebreathing circuits, because the location of the fresh gas tube does not allow sufficient space for expiration (Sinclair and Van Bergen, 1992). Swiveling straight adaptors are used to relieve torque in the connection between the endotracheal tube and the breathing circuit.

Right-angle adaptors, or elbows, are often used to aid in positioning the breathing circuit. They are made with small ports for sampling and analysis of airway gases and with larger ports to facilitate bronchoscopy. Some examples of these are seen in Fig. 5-50.



Fig. 5-49 Low Dead Space Adaptors. These endotracheal tube connectors greatly reduce the dead space compared with a standard 15 mm connector. The adaptors seen include a sampling port for side stream respiratory gas monitoring. Credit: Courtesy of Hallowell, EMC.

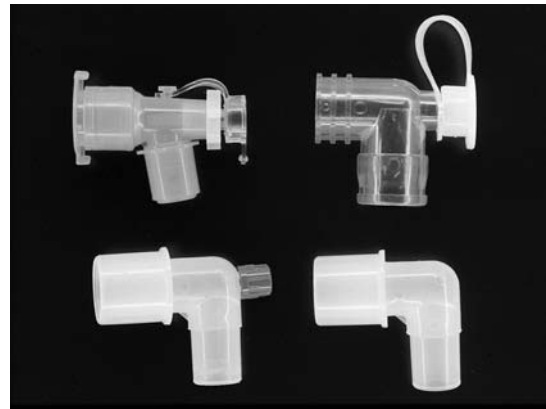

Fig. 5-50 Right-Angle Endotracheal Tube Adaptors or Elbows. (Top right) Elbow with endoscope port. (Top left) Swiveling elbow with endoscope port. (Bottom right) Conventional elbow. (Bottom left) Elbow with gas sampling port. The sampling port is fitted with a sealing cap.



Fig. 5-51 LMA™ Classic Laryngeal Mask Airways. The silicone masks are shown from right to left in sizes 1, 1½, 2, 2½, 3, 4, 5, and 6. Size 1 is recommended for human neonates or infants weighing less than 5 kg, and size 6 for human adults weighing over 100 kg. Credit: Courtesy of LMA North America, Inc.

2. Laryngeal Mask Airways

Laryngeal mask airways are designed for use in humans as an alternative to endotracheal intubation. The device is a short tube with a standard 15 mm breathing circuit connector, terminating in a cuffed, concave silicone mask to fit over the laryngeal entry to the trachea (Fig. 5-51). Laryngeal masks can be inserted blindly or under direct vision using a laryngoscope. Currently, laryngeal masks are available in a range of sizes, no. 1 being the smallest. The mask can be inserted blindly, with the concave side facing the tongue, and the position adjusted to assure optimum ventilation. The balloon is inflated to attain a seal. Cuff inflation pressures of 60 cm H₂O or less are suggested for humans. Stridor or audible leaks indicate improper position, corrected by repositioning.

The perceived difficulty of endotracheal intubation in rabbits has prompted assessment of laryngeal mask airways and laryngeal tubes. In most reports, size 1 masks were used. Long et al. (2003) studied three rabbits, weighing 3–5 kg, and reported easy insertion and positioning of the laryngeal mask. In their study, the mask seal was inflated to 20 cm H₂O, and the rabbits were mechanically ventilated. End-tidal CO₂ and SpO₂ remained within normal limits for the duration of the 60-minute test period, but one animal developed cyanosis of the tongue, attributed to obstruction of venous outflow. Smith et al. (2004) examined the ease of insertion and personnel exposure to isoflurane levels in eight rabbits using uncuffed and cuffed endotracheal tubes, and laryngeal mask airways without cuff inflation. They concluded that laryngeal masks were easier to insert for personnel at all levels of training and experience, and that leakage from the masks was comparable to that from the endotracheal tubes. Using 16 rabbits in 3 groups, Bateman et al. (2005) compared conventional facemasks during spontaneous ventilation with laryngeal masks during both spontaneous and controlled ventilation. In their study, the mask cuffs were not inflated. They encountered airway obstruction in all animals when conventional masks were used during preparation. In three of the animals, obstruction could not be relieved by repositioning the head or swabbing the oropharynx, but was alleviated when a laryngeal mask was used. During controlled ventilation, four of six animals developed gastric tympany. They concluded that laryngeal mask airways were superior to conventional masks in terms of airway maintenance. Kazakos et al. (2007) examined the performance of laryngeal masks in a series of 50 rabbits undergoing surgery. The animals ranged in size from 3.1 to 4.3 kg, and a size 1 mask was found to be satisfactory. In smaller rabbits, the mask cuff was not inflated. The authors suggest that 2.5 kg may be the lower limit for size 1 laryngeal masks in rabbits, and that size 1.5 masks may be appropriate for some rabbits weighing over 4.0 kg. Tongue cyanosis was encountered in four of the animals, attributed to compression of the lingual artery. It was successfully alleviated by deflating the cuff, repositioning the airway, and in a single instance replacing a size 1.5 airway with a size 1 airway. Leakage was assessed by placing an agent monitor sampling line in the mouth, and no volatile agent was detected. The authors concluded that, while the airway must be inserted carefully to avoid damage to the cuff, insertion was easy with proper technique and the device functioned well to maintain anesthesia and to support manual ventilation during surgery.

Similar studies have been performed with cats (Asai et al., 1988; Cassu et al., 2004). In both studies, size 2 laryngeal masks were found to be easy to insert and in most instances, maintained a patent airway with no further intervention. Asai et al., studied 60 cats, using sevoflurane to induce and maintain anesthesia, with no premedication. Vecuronium was used during controlled ventilation. They noted greater increases in heart rate with endotracheal intubation than with insertion of the laryngeal mask, and encountered some difficulty maintaining a patent airway

using size 2 laryngeal masks in cats weighting less than 2.5 kg. Cassu et al., in their study of 32 cats, premedicated their animals and maintained anesthesia with halothane at about 0.5 MAC. Pancuronium was used during controlled ventilation. In contrast to Asai et al., they observed no differences in heart rate in response to insertion of endotracheal tubes and laryngeal masks, possibly attributable to differences in premedication and anesthetic maintenance protocols between the two studies. Gastric reflux was noted during controlled ventilation in both groups, with a somewhat higher incidence in the laryngeal mask group, but not during spontaneous ventilation in either group. Respiratory and arterial blood gas values were similar in all groups, with moderately higher end-tidal CO₂ and PaCO₂ values seen with the use of laryngeal masks during spontaneous ventilation and controlled ventilation. These differences may reflect the higher dead space of laryngeal masks compared to conventional endotracheal tubes. In summary, it appears that laryngeal mask airways may be used successfully in cats.

Braz et al. (1999) assessed the use of size 4 laryngeal masks in dogs, and concluded that they were satisfactory for maintenance of a patent airway. Wiederstein et al. (2006) compared the dose of propofol needed for insertion of laryngeal masks and conventional cuffed endotracheal tubes in 60 dogs. Pairs of dogs were matched based on breed or skull anatomy, age, and weight. Either laryngeal masks ranging in size from 1 to 6, or appropriately sized endotracheal tubes were used. Following a standard premedication, an attempt was made to insert either an endotracheal tube or a laryngeal mask by direct laryngoscopy. If the attempt failed due to inadequate anesthetic depth, propofol was administered, and a second attempt was made. In 30 dogs, the laryngeal mask was inserted without propofol, with the remaining 16 requiring a single dose. In the endotracheal tube group, intubation was possible in a single animal without the use of one or two doses of propofol. The mean dose of propofol needed for insertion of a laryngeal mask was approximately one-third of that needed for insertion of an endotracheal tube.

Wemyss-Holden et al. (1999) examined the use of size 4 laryngeal masks in 10 pigs weighing from 24 to 33 kg. In spontaneously breathing pigs premedicated with ketamine and xylazine and maintained with halothane, they found the masks to be a satisfactory and simple alternative to endotracheal intubation. A laryngeal mask with an accessory port for insertion of a gastric drainage tube, the LMA-ProSeal™ was assessed for use in pigs by Goldmann et al. (2005). They rated ease of insertion, adequacy of seal during controlled ventilation, and access for insertion of a gastric drainage tube in 12 pigs weighing 25–62 kg. The weight of the pigs increased in approximately 5 kg increments, and the appropriate size laryngeal mask was determined at each interval. Laryngeal mask sizes were size 3 at 25 kg, 4 from 30 to 43 kg, and 5 from 47 to 62 kg, although the authors caution that these are only preliminary estimates. The LMA-ProSeal was found to be easy to insert under direct laryngoscopy, provided easy access for placement of a gastric

drain tube, and attained an adequate seal to maintain normal arterial blood gas values using controlled ventilation.

The design and dimensions of laryngeal mask airways are based on molds of the adult human larynx, proportionately scaled to create a range of sizes (Diba, 2005c). It is surprising that they work as well as they do in animals. However, experience with their use is limited and, especially in smaller animals, not entirely satisfactory (Bateman et al., 2005; Brietzke and Mair, 2001). As seen in some of the previous studies, laryngeal masks may render animals more prone to reflux of gastric contents and gastric dilatation than conventional endotracheal tubes. If high ventilation pressure is required, the mask may not provide a sufficient seal. Even so, in some applications, laryngeal masks offer a reasonable alternative to conventional endotracheal intubation. Phaneuf et al. (2006) suggest that rabbits may be predisposed to tracheal injury associated with conventional endotracheal tubes. This is a cause for concern, although the frequency of clinically significant complications is unclear, and may be expected to vary widely with the protocols and practices used. Clearly, however, a safe and simpler alternative to endotracheal intubation would be welcome.

The laryngeal tube is similar in function to a laryngeal mask airway. It differs in design by having a distal, esophageal balloon to occlude the esophagus, and a more proximal, larger balloon to seal the pharynx. A fenestration between the cuffs is centered over the laryngeal aditus, providing a pathway for ventilation. Yamamoto et al. (2007) used a size 0 tube in six rabbits, weighing 3.2–3.9 kg, to maintain isoflurane anesthesia and to assess ventilation during neuromuscular blockade. Intubation was successful on the first attempt in four of six animals, and on the second attempt in the remaining animals after complete deflation of the cuffs. Based on capnography, ventilation was well supported with, or without, neuromuscular blockade. Leakage of volatile anesthetic was not assessed.

Imai et al. (2004) report the design of a novel device intended for use in small laboratory animals. The device shares some similarities with the laryngeal mask airway and with the laryngeal tube, with the balloon placed distally, to act as an esophageal obturator. The device was designed based on molds taken from rabbits, ferrets, rats, and mice, and tested using rabbits. Blind insertion was relatively easy, and the device was effective and equivalent in performance to a conventional endotracheal tube for both spontaneous and controlled ventilation. Mild pharyngeal redness and localized swelling were seen in three of the six rabbits following extubation. The device was not commercially available and remained in development at the time this chapter was written.

3. Rodent Endotracheal Tubes

Intravenous catheters or laboratory tubing are commonly used in rodents. In adult rats, 14G or 16G catheters are usually suitable, although a smaller catheter may be needed for juvenile animals. As with other animals, the tube size is limited not by tracheal diameter, but rather by the smaller diameter

of the larynx adjacent to the tracheal opening. The tip of the catheter may be trimmed to create a bevel of approximately 40° to facilitate passage into the trachea. When trimming a tube or catheter to create a bevel, it is essential that the tip is left rounded, and does not come to a sharp point. A new razor blade or scalpel will yield the best results. Intravenous catheters offer some advantages over laboratory tubing. They are designed with materials known to be compatible with tissues, and tend to become softer as they are warmed to body temperature. Polyurethane catheters are softer at body temperature than many other materials. Catheters also have thin walls and a favorable ratio of inner to outer diameter, offering the least resistance to breathing. Finally, the female Luer fitting is easily connected to breathing circuits. Some intravenous catheters have a notch on the hub of the Luer fitting to facilitate suturing the catheter in place, and equally useful for tying the tube over the nose with umbilical tape or, in mice, suture. In mice, 20G catheters are often used. Brown et al. (1999) used PE-90 polyethylene tubing to make an endotracheal tube for mice weighing 20–25 g. The tubing has an OD of 1.27 mm, about 20% larger than a 20G catheter. Ideally, the rule of using the largest endotracheal tube that can be placed without causing trauma should also apply to rodents, but a more limited selection of catheter and tubing sizes complicates the issue.

Rodent endotracheal tubes are not, for obvious reasons, available with inflatable cuffs. It has been suggested that a small piece of tubing placed over the catheter can be used to limit the distance it is introduced into the trachea and to limit leaking around the tube. As with Cole tubes, however, it seems inadvisable to rest the stop against the larynx in animals intended to recover from anesthesia.

C. Stylets, Guides, and Tube Exchangers

The term “stylet” is somewhat elastic. It can refer to rigid or malleable rods or wires used to adjust the curve of an endotracheal tube in order to make insertion easier. Used this way, in order to avoid airway trauma, the stylet should not extend beyond the tip of the tube. Many types of stylets are sold for this purpose, usually coated with smooth plastic to make withdrawal from the tube easier, and often having an adjustable stop mechanism to limit their working length (Fig. 5-52). Alternatively, the malleable stylet can be bent sharply at the tube connector to accomplish the same end. Lighted malleable stylets are available.

Endotracheal tube introducers, intubation guides, intubation stylets, and bougies, all refer to flexible tubes inserted into the trachea and used to guide an endotracheal tube threaded over them into the correct position. They are sufficiently rigid to pass into the trachea, but smooth and flexible enough to avoid injury. Intubation guides are used when vision is limited and the endotracheal tube would obscure the tracheal opening as it is advanced. They can be used several ways. If the view of the tracheal opening is very limited, or if the tracheal opening

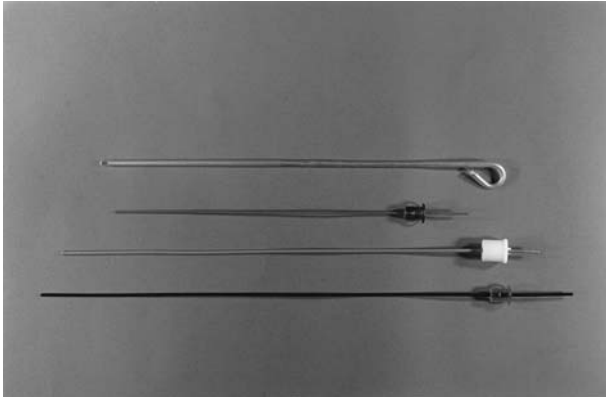

Fig. 5-52 Commercial Endotracheal Tube Stylets. The top three are smooth plastic coated malleable wires with stops that can be adjusted to prevent the stylet from extending beyond the tip of the endotracheal tube. The bottom stylet is a heavier malleable rod encased in clear plastic, also equipped with an adjustable stop.

is very small, an intubation guide can be directed into the trachea under direct vision and held in place while an endotracheal tube is threaded over it. This technique is sometimes referred to as railroading the tube. In rodents, a Seldinger guide wire is sometimes used as an intubation aid. For convenient use, the guide wire should be relatively short, but because Seldinger guide wires consist of a spring encircling a stiffer inner wire, they cannot easily be shortened simply by cutting them. Alternatively, the guide can be placed within the lumen of the tube to extend a desired distance beyond the tip, and held in place while the guide and endotracheal tube are advanced as a single unit. This technique is often useful in pigs, small ruminants and other species in which the view is likely to be obscured as the endotracheal tube approaches the tracheal opening. The BioLITE™, previously described, is used in this way as a lighted, flexible intubation guide for rodents. Both methods are relatively easy to use, but require some practice.

Tube exchangers, as the name suggests, are used to exchange a defective or unsatisfactory endotracheal for a functional one. They are passed through the lumen of the defective tube, which is then withdrawn over the tube exchanger and replaced with a new tube, after which the exchanger is withdrawn. Tube exchangers are commercially available in human adult and pediatric sizes. Their physical characteristics are similar to those of intubation guides, but they are generally longer, especially in adult sizes, and some have connections to permit insufflation with oxygen, or even jet ventilation during the exchange. Pediatric tube exchangers may be used as intubation guides in many species.

ADDITIONAL READING

“*Understanding Anesthesia Equipment*,” 4th ed. (Jerry A. Dorsch and S.E. Dorsch, eds.). Williams & Wilkins, Baltimore, MD. (1999). ISBN 0 683 30487 9.

In addition to the current edition, previous editions are especially useful for information regarding older machines and equipment.

“*Ward’s Anaesthetic Equipment*,” 5th ed. (Andrew J. Davey and Ali Diba, eds.). Elsevier Saunders, Amsterdam. (2005). ISBN 1 4160 2558 8.

“*Lumb & Jones’ Veterinary Anesthesia and Analgesia*,” 4th ed. (William Tranquilli, John Thurmon, and Kurt Grimm, eds.). Blackwell Publishing. (2007). ISBN 978078175471.

“*Basic Physics and Measurement in Anaesthesia*,” 5th ed. (Paul D. Davis and Gavin C. Kenny, eds.). Butterworth Heinemann, Philadelphia, PA. (2003). ISBN 0 7506 4828 7.

REFERENCES

- Abud, T.M.V., Cerqueira, J.R., Martins, R.H.G., Gregorio, E.A., Sadanha, J.C., and Raiza, A.C.P. (2004). The Lanz® endotracheal tube decreases tracheal injury in dogs. *Can. J. Anaesth.* **58**(8), 878–882.
- Alpert, M., Goldstein, D., and Triner, L. (1982). Technique of endotracheal intubation in rats. *Lab. Anim. Sci.* **32**(1), 78–79.
- Andrews, J.J. (1990). Inhaled anesthesia delivery systems. In “Anesthesia.” (R. Miller, ed.), 3rd ed., pp 171–223. Churchill-Livingstone, New York.
- Asai, T., Murao, K., Katoh, T., and Shingu, K. (1988). Use of laryngeal mask airway in laboratory cats. *Anesthesiology* **88**(6), 1680–1682.
- Banner, M.J., and Lamptang, S. (1992). Mechanical ventilators—Fundamentals. In “Handbook of Mechanical Ventilatory Support.” (A. Perel and M. Christine Stock, eds.), pp 7–30. Williams & Wilkins, Baltimore, MD.
- Bateman, L., Ludders, J.W., Glead, R.D., and Erb, H.N. (2005). Comparison between facemask and laryngeal mask airway in rabbits during isoflurane anesthesia. *Vet. Anaesth. Analg.* **32**, 280–288.
- Bednarski, R.M. (1993). Anesthetic breathing systems. In “Anesthetic Equipment” (R.M. Bednarski, ed.), Seminars in Veterinary Medicine and Surgery (Small Animal), Vol. 8, No. 2, pp 82–89. Saunders, Philadelphia, PA.
- Benumof, J.L., Schroff, P.K., and Skerman, J.H. (1992). Transtracheal ventilation. In “Clinical Procedures in Anesthesia and Intensive Care” (J.L. Benumof, ed.), pp 195–209. Lippincott, Philadelphia, PA.
- Bivas-Benmita, M., Zwier, R., Junginger, H.E., and Borchard, G. (2005). Non-invasive pulmonary aerosol delivery in mice by the endotracheal route. *Eur. J. Pharm. Biopharm.* **61**, 214–218.
- Bland, H. (2005a). The supply of anaesthetic and other medical gases. In “Ward’s Anaesthetic Equipment.” (A.J. Davy and A. Diba, eds.), 5th ed., pp 28–32. Elsevier Saunders, Philadelphia, PA.
- Bland, H. (2005b). The supply of anaesthetic and other medical gases. In “Ward’s Anaesthetic Equipment.” (A.J. Davy and A. Diba, eds.), 5th ed., p 47. Elsevier Saunders, Philadelphia, PA.
- Boersma, F.P., and Wieringa, R.A. (1982). A method for safe and fast intubation of the rat trachea under direct vision. *Anaesthetist* **31**(5), 239–240.
- Braz, J.E., Martins, R.G.H., Mori, A.R., and Luna, S.P.L. (1999). Investigation into the use of the laryngeal mask airway in pentobarbital anesthetized dogs. *Vet. Surg.* **28**(6), 502–505.
- Brietzke, S.E., and Mair, E.A. (2001). Laryngeal mask versus endotracheal tube in a ferret model. *Ann. Otol. Rhinol. Laryngol.* **110**(9), 827–833.
- British Compressed Gas Association. (2005). “Cylinder Identification Color Coding and Labelling Requirements”. Technical Information Sheet 6: Rev 1. British Compressed Gas Association, Wallingford, Oxfordshire.
- Brown, R.H., Walters, D.M., Greenberg, R.S., and Mitzner, W. (1999). A method of endotracheal intubation and repeated studies in mice. *J. Appl. Physiol.* **87**(6), 2362–2365.
- Cambon, H., Latulippe, J-F., Nguyen, T., and Cartier, R. (1995). Orotracheal intubation of rats by transillumination. *Lab. Anim. Sci.* **45**(3), 303–304.
- Cassu, R.N., Luna, S.P.L., Neto, F.J.T., Braz, J.R.C., Gasparini, S.S., and Crocci, A.J. (2004). Evaluation of laryngeal mask as an alternative to

- endotracheal intubation in cats anesthetized under spontaneous or controlled ventilation. *Vet. Anesth. Analg.* **31**(6), 213–221.
- Compressed Gas Association, Inc. (1996, Reaffirmed 2005). "Characteristics and Safe Handling of Medical Gases." 8th ed. (CGA P-2—1996). Compressed Gas Association, Inc., Chantilly, VA.
- Conway, C.M. (1985). Anaesthetic Breathing Systems. *Br. J. Anaesth.* **57**, 649–657.
- Coppens, M.J., Versichelen, L.F.M., Rolly, G., Mortier, E.P., and Strys, M.M.R.F. (2006). The mechanisms of carbon monoxide production by inhalational agents. *Anesthesia* **61**, 462–468.
- Cornick-Seahorn, J., Cuvelliez, S., Gaynor, J., McGrath, C., and Hartsfield, S. (1996). Commentary and recommendations on control of waste anesthetic gases in the workplace. *JAVMA* **209**(1), 75–77.
- Costa, D.L., Lehmann, J.R., Harold, W.M., and Drew, R.T. (1986). Transoral tracheal intubation of rodents using a fiberoptic laryngoscope. *Lab. Anim. Sci.* **36**(3), 256–261.
- Darma, S.S., and Pua, H.L. (2000). A nonoccluding bag and closed scavenging system for the Jackson-Rees modified T-piece breathing system. *Anaesthesia* **55**, 450–454.
- Davey, A.J. (2005a). Vaporizers. In "Ward's Anaesthetic Equipment." (A.J. Davey and A. Diba, eds.), 5th ed., pp 65–89. Elsevier Saunders, Philadelphia, PA.
- Davey, A.J. (2005b). Breathing systems and their components. In "Ward's Anaesthetic Equipment." (A.J. Davey and A. Diba, eds.), 5th ed., pp 131–163. Elsevier Saunders, Philadelphia, PA.
- Davey, A.J. (2005c). Automatic ventilators. In "Ward's Anaesthetic Equipment." (A.J. Davey and A. Diba, eds.), 5th ed., pp 241–269. Elsevier Saunders, Philadelphia, PA.
- Davis, P.D., and Kenny, G.N.C. (2003a). The gas laws. In "Basic Physics and Measurement in Anaesthesia." 5th ed., pp 47–49. Butterworth Heinemann, Edinburgh.
- Davis, P.D., and Kenny, G.N.C. (2003b). Breathing and scavenging systems. In "Basic Physics and Measurement in Anaesthesia." 5th ed., p 247. Butterworth Heinemann, Edinburgh.
- Diba, A. (2005a). The anaesthetic workstation. In "Ward's Anaesthetic Equipment." (A.J. Davy and A. Diba, eds.), 5th ed., pp 91–130. Elsevier Saunders, Philadelphia, PA.
- Diba, A. (2005b). Infusion equipment and intravenous anaesthesia. In "Ward's Anaesthetic Equipment." (A.J. Davy and A. Diba, eds.), 5th ed., pp 409–426. Elsevier Saunders, Philadelphia, PA.
- Diba, A. (2005c). Airway management devices. In "Ward's Anaesthetic Equipment." (A.J. Davy and A. Diba, eds.), 5th ed., pp 165–214. Elsevier Saunders, Philadelphia, PA.
- Dorsch, J.A., and Dorsch, S.E. (1999a). Medical gas cylinders and containers. In "Understanding Anesthesia Equipment." 4th ed., pp 15–22. Williams & Wilkins, Baltimore, MD.
- Dorsch, J.A., and Dorsch, S.E. (1999b). The anesthesia machine. In "Understanding Anesthesia Equipment." 4th ed., pp 82–83. Williams & Wilkins, Baltimore, MD.
- Dorsch, J.A., and Dorsch, S.E. (1999c). The circle system. In "Understanding Anesthesia Equipment." 4th ed., pp 234–236. Williams & Wilkins, Baltimore, MD.
- Dorsch, J.A., and Dorsch, S.E. (1999d). The breathing system. In "Understanding Anesthesia Equipment." 4th ed., pp 183–205. Williams & Wilkins, Baltimore, MD.
- Dorsch, J.A., and Dorsch, S.E. (1999e). Vaporizers (anesthetic agent delivery devices). In "Understanding Anesthesia Equipment." 4th ed., pp 121–181. Williams & Wilkins, Baltimore, MD.
- Dorsch, J.A., and Dorsch, S.E. (1999f). Mapleson breathing systems. In "Understanding Anesthesia Equipment." 4th ed., pp 207–227. Williams & Wilkins, Baltimore, MD.
- Dorsch, J.A., and Dorsch, S.E. (1999g). Equipment checking and maintenance. In "Understanding Anesthesia Equipment." 4th ed., pp 937–965. Williams & Wilkins, Baltimore, MD.
- Dorsch, J.A., and Dorsch, S.E. (1999h). Tracheal tubes. In "Understanding Anesthesia Equipment." 4th ed., pp 557–675. Williams & Wilkins, Baltimore, MD.
- Eger, E.I., Eisenkraft, J.B., and Weiskopf, R.B. (2002). Physical properties. In "The pharmacology of inhaled anesthetics." P. 8. Library of Congress Number TXV1-035635. (Note: No publisher is listed for this book, which appears to have been sponsored by the Dannemiller Memorial Educational Foundation and supported by Baxter healthcare. The copyright is in the name of the first author.)
- Glen, J.B., Cliff, G.S., and Jamieson, A. (1980). Evaluation of a scavenging system for use with inhalation anaesthesia techniques in rats. *Lab. Anim.* **14**(3), 207–211.
- Goldmann, K., Kalinowski, M., and Kraft, S. (2005). Airway management under general anaesthesia in pigs using the LMA-ProSeal™: A pilot study. *Vet. Anaesth. Analg.* **32**, 308–311.
- Golledge, H. (2006). Animal Welfare Aspects of Carbon Dioxide Euthanasia. Presentation at the Charles River Laboratories 20th Annual Short Course, Newton, MA.
- Gravenstein, J.S., Paulus, D.A., and Hayes, T.J. (1989). Dead space. In "Capnography in Clinical Practice," pp 31–41. Butterworths, Boston.
- Gross, P. (1958). A self-retaining illuminated laryngoscopic speculum for intratracheal procedures. *AMA Arch. Ind. Health* **18**, 429–430.
- Hallowell, S. (2006). Personal communication.
- Harper, J. (2007). Personal communication.
- Hartsfield, S. (1996a). Anesthetic machines and breathing systems. In "Lumb & Jones' Veterinary Anesthesia." 3rd ed., pp 367–372. Williams & Wilkins, Baltimore, MD.
- Hartsfield, S. (1996b). Airway management and ventilation. In "Lumb & Jones' Veterinary Anesthesia." 3rd ed., pp 515–556. Williams & Wilkins, Baltimore, MD.
- Healy, T.E.J., Harrison, M.J., and Thornton, J.A. (1991). Basic mathematical functions. In "Aids to Anaesthesia." 3rd ed. Churchill Livingstone, Edinburgh.
- Heavner, J.E., Flinders, C., McMahon, D.J., Branigen, T., and Bagdell, J.M. (1989a). Medical gases. In "Technical Manual of Anesthesiology: An Introduction," pp 130–155. Raven Press, New York.
- Hendrickx, J.F.A., De Cooman, S., Deloof, T., Vandeput, D., Coddens, J., and DeWolf, A.M. (2000). The ADU vaporizing unit: A new vaporizer. *Anesth. Analg.* **93**, 391–395.
- Henry, R.T., and Casto, R. (1989). Simple and inexpensive delivery of halogenated inhalation anesthetics to rodents. *Am. J. Physiol.* **257** (Regul. Integr. Comp. Physiol. **26**), R688–R671.
- Hey, V.M., and Pleuvry, B.J. (1973). Oro-tracheal intubation in the rat. *Br. J. Anaesth.* **45**(7), 732.
- Hodgson, D.S. (2007). Anesthetic concentrations in enclosed chambers using an innovative delivery device. *Vet. Anesth. Analg.* **34**(2), 99–106.
- Hoffman, R.J., Parwani, V., and Hahn, I.-H. (2006). Experienced emergency medicine physicians cannot safely inflate or estimate endotracheal tube cuff pressure using standard techniques. *Am. J. Emerg. Med.* **24**, 139–143.
- Humphrey, D., Brock-Utme, J.G., and Downing, J.W. (1986a). Single lever Humphrey A.D.E. lowflow universal anesthetic breathing system. Part I: Comparison with dual lever A.D.E., Magill and Bain systems in anaesthetized spontaneously breathing adults. *Can. Anaesth. Soc.* **33**(6), 698–709.
- Humphrey, D., Brock-Utme, J.G., and Downing, J.W. (1986b). Single lever Humphrey A.D.E. lowflow universal anesthetic breathing system. Part II: Comparison with Bain system in anaesthetized adults during controlled ventilation. *Can. Anaesth. Soc.* **33**(6), 710–718.
- Hunter, S.E., Glen, J.B., and Butcher, C.J. (1984). A modified anaesthetic vapour extraction system. *Lab. Anim.* **18**, 42–44.
- Hranicka, L.J., Moy, S.K., and Funahashi, A. (1977). Fiberoptic laryngoscope for small laboratory animals. *Lab. Anim. Sci.* **27**(6), 1004–1006.
- Imai, A., Eisele, P.M., and Steffey, E.P. (2004). A new airway device for small laboratory animals. *Lab. Anim.* **39**(1), 111–115.
- Jaffe, R.M., and Free, M.J. (1973). A simple endotracheal intubation technique for inhalation anesthesia of the rat. *Lab. Anim. Sci.* **23**(2), 266–269.

- Jou, I.-M., Tsai, Y.-T., Tsai, C.-L., Wu, M.-H., Chang, H.Y., and Wang, N.-S. (2000). Simplified rat intubation using a new oropharyngeal intubation wedge. *J. Appl. Physiol.* **89**, 1766–1770.
- Kastl, S., Kotschenreuther, U., Hille, B., Schmidt, J., Gepp, H., and Hohenberger, W. (2004). Simplification of rat intubation on inclined metal plate. *Adv. Physiol. Educ.* **28**, 29–32.
- Kazakos, G.M., Anagnostou, T., Savvas, I., Raptopoulos, D., Psalla, D., and Kazakou, I.M. (2007). Use of the laryngeal mask airway in rabbits: Placement and efficiency. *Lab. Anim. Sci.* **36**(4), 29–34.
- Kharasch, E.D., Powers, K.M., and Artu, A.A. (2002). Comparison of Amsorb[®], sodalime, and Baralyme[®] degradation of volatile anesthetics and formation of carbon monoxide and compound A in swine in vivo. *Anesthesiology* **96**, 173–182.
- LaChappell, S. (2006). Personal communication.
- Lerche, P., Muir, W.W. III, and Bednarski, R.M. (2000a). Rebreathing anesthetic systems in small animals. *J. Am. Vet. Med. Assoc.* **217**(4), 485–492.
- Lerche, P., Muir, W.W. III, and Bednarski, R.M. (2000b). Nonbreathing anesthetic systems in small animals. *J. Am. Vet. Med. Assoc.* **217**(4), pp 493–497.
- Levy, D.E., Zweis, A., and Duffy, T.E. (1980). A mask for delivery of inhalation gases to small laboratory animals. *Lab. Anim. Sci.* **30**(5), 868–870.
- Li, W., Tse, J.H., James, A.E., Kik-Wang, L., Chi-Kwan, Y., Man-Po, C., and Chung, S.C.S. (2001). Delivery and scavenging system for small animal inhalational anesthesia. *J. Surg. Res.* **99**, 175–178.
- Linden, R.D., Shields, C.B., Zhang, Y.P., Edmonds, H.L., and Hunt, M.A. (2000). A laryngoscope designed for intubation of the rat. *Contemp. Top. Lab. Anim. Sci.* **39**(2), 40–42.
- Lizio, R., Westhof, A., Lehr, C.-M., and Kenner, T. (2001). Oral endotracheal intubation of rats for intratracheal instillation and aerosol drug delivery. *Lab. Anim.* **35**(3), 257–260.
- Long, J.P., Ngala, V.R., Foresman, L.J., Borkowski, G.L., and Gomez, D. (2003). The use of a laryngeal mask airway (LMA) in the rabbit: An alternative to endotracheal intubation. *Contemp. Top. Lab. Anim. Sci.* **42**, 92 (Abst. PO 30).
- Mason, D.E. (1993). Anesthesia machine checkout and troubleshooting. In “Anesthetic Equipment.” (R.M. Bednarski, ed.), Seminars in Veterinary Medicine and Surgery (Small Animal), Vol. 8, No. 2, pp 104–108. Saunders, Philadelphia, PA.
- Manley, S.V., and McDonnell, W.N. (1979). Clinical evaluation of the Bain breathing circuit in small animal anesthesia. *J. Am. Anim. Hosp. Assoc.* **15**, 67–72.
- Mapleson, W.W. (1954). The elimination of rebreathing in various semi-closed anaesthetic systems. *Br. J. Anaesth.* **26**, 323–332.
- McGarrick, J., and Thexton, A. (1979). A safer open-circuit anaesthetic system for administering halothane to rats. *J. Physiol.* **289**, 15P–16P.
- McMurphy, R.M., Hodgson, D.S., and Cribb, P.H. (1995). Modification of a nonbreathing circuit adapter to prevent barotrauma in anesthetized patients. *Vet. Surg.* **24**, 352–355.
- Medd, R.K., and Heywood, R. (1970). A technique for intubation and repeated short-duration anaesthesia in the rat. *Lab. Anim.* **41**(1), 75–78.
- Molthen, R.C. (2006). A simple, inexpensive, and effective light-carrying laryngoscopic blade for orotracheal intubation in rats. *J. AALAS* **45**(1), 88–78.
- Morgan, P.J. (1982). A modified laryngoscope blade for rat intubation. *Anaesthesiology* **57**(5), 431.
- Olympio, M.A. (2005). Carbon dioxide absorbent desiccation safety conference. Anesthesia Patient Safety Foundation Newsletter 2005, Summer. http://apsf.org/resource_center/newsletter/2005/summer/01co2.htm
- Pena, H., and Cabrera, C. (1980). Improved endotracheal intubation technique in the rat. *Lab. Anim. Sci.* **30**(4 Pt 1), 712–713.
- Petty, W.C., and Sosis, M.B. (1997a). Compressed gases and pressure regulators. In “Anesthesia Equipment Manual.” (M.B. Sosis, ed.), pp 42–45. Lippincott-Raven, Philadelphia, PA.
- Petty, W.C., and Sosis M.B. (1997b). Compressed gases and pressure regulators. In “Anesthesia Equipment Manual.” (M.B. Sosis, ed.), pp 47. Lippincott-Raven, Philadelphia, PA.
- Petty, W.C., and Sosis M.B. (1997c). Safety features of the anesthesia machine. In “Anesthesia Equipment Manual.” (M.B. Sosis, ed.), pp 52. Lippincott-Raven, Philadelphia, PA.
- Phaneuf, L.R., Barker, S., Groleau, M.A., and Turner, P.V. (2006). Tracheal injury after endotracheal intubation and anesthesia in rabbits. *J. Am. Assoc. Lab. Anim. Sci.* **45**(6), 67–72.
- Proctor, E., and Fernando, A.R. (1973). Oro-endotracheal intubation in the rat. *Br. J. Anaesth.* **45**, 139–141.
- Rivard, A.L., Mohammed, S., Magembe, A.J., Pearson, H.M., Hallman, M.R., Barnett, S.J., Gatlin, D.L., Gallegos, R.P., and Bianco, R.W. (2006). Rat intubation and ventilation for surgical research. *J. Invest. Surg.* **19**(4), 267–274.
- Rivera, B., Miller, S.R., Brown, E.A., and Price, R.E. (2005). A novel method for endotracheal intubation of mice and rats used imaging studies. *Contemp. Top. Lab. Anim. Sci.* **44**(2), 52–55.
- Schaefer, C.F., Brackett, D.J., Downs, P., Tompkins, P., and Wilson, M.F. (1984). Laryngoscopic endotracheal intubation of rats for inhalation anesthesia. *J. Appl. Physiol. Respir. Environ. Exerc. Physiol.* **56**(2), 533–535.
- Sinclair, A., and Van Bergen, J. (1992). Flow resistance of coaxial breathing systems: Investigation of a circuit disconnect. *Can. J. Anaesth.* **39**(1), 90–94.
- Smith, C., Flynn, C., Wardall, G., and Broome, I.J. (2002). Leakage and absorption of isoflurane by different types of anaesthetic circuit and monitoring tubing. *Anaesthesia* **57**(7), 686–689.
- Smith, J.C., and Bolon, B. (2006). Isoflurane leakage from non-rebreathing rodent anaesthesia circuits: Comparison of emissions from conventional and modified ports. *Lab. Anim.* **40**(20), 200–209.
- Smith, J.C., Robertson, L.D., Auhll, A., March, T.J., Derring, C., and Bolon, B. (2004). Endotracheal tubes versus laryngeal mask airways in rabbit inhalation anesthesia: Ease of use and waste gas pollution. *Contemp. Top. Lab. Anim. Sci.* **43**(4), 22–25.
- Stark, R.A., Narhwold, M.J., and Cohen, P.J. (1981). Blind oral intubation of rats. *J. Appl. Physiol. Respir. Environ. Exerc. Physiol.* **51**(5), 1355–1356.
- Targ, A.G., Yasuda, N., and Eger, E.I. II. (1989). Solubility of I-653, sevoflurane, isoflurane, and halothane in plastics and rubber composing a conventional anaesthetic circuit. *Anesth. Analg.* **69**(2), 218–225.
- Theodorsson, A., Holm, L., and Theodorsson, E. (2005). Modern anesthesia and preoperative monitoring methods reduce per- and postoperative mortality during transient occlusion of the middle cerebral artery in rats. *Brain Res. Protoc.* **14**(3), 181–190.
- Thet, L.A. (1983). A simple method of intubating rats under direct vision. *Lab. Anim. Sci.* **33**(4), 368–369.
- Tran, D.Q., and Lawson, D. (1986). Endotracheal intubation and manual ventilation of the rat. *Lab. Anim. Sci.* **36**(5), 540–541.
- U.S. Food and Drug Administration, Center for Devices and Radiological Health. (2006). FDA and NIOSH Public Health Notification: Oxygen Regulator Fires Resulting from Incorrect Use of CGA 870 Seals. Updated June 19, 2006.
- Walsh, C.M., and Taylor, P.M. (2004). A clinical evaluation of the ‘mini parallel Lack’ breathing system in cats and comparison with a modified Ayre’s T-piece. *Vet. Anaesth. Analg.* **31**, 207–212.
- Weksler, B., Bruce, N., Lenert, J., and Burt, M. (1994). A simplified method for endotracheal intubation in the rat. *J. Appl. Physiol.* **76**(4), 1823–1825.
- Wemyss-Holden, S.A., Porter, K.J., Baxter, P., Rudkin, G.E., and Maddern, G.J. (1999). The laryngeal mask airway in experimental pig anaesthesia. *Lab. Anim.* **33**(1), 30–34.
- Wiederstein, I., Auer, U., and Moens, Y. (2006). Laryngeal mask airway insertion requires less propofol than endotracheal intubation in dogs. *Vet. Anaesth. Analg.* **33**(4), 201–206.
- Yamamoto, Y., Inoue, S., Abe, R., Kawaguchi, M., and Furuya, H. (2007). Airway management with the laryngeal tube in rabbits. *Lab. Anim.* **36**(5), 33–35.
- Yasaki, S., and Dyck, P.J. (1991). A simple method for rat endotracheal intubation. *Lab. Anim. Sci.* **41**(6), 620–622.

This page intentionally left blank

Monitoring of Anesthesia

Jennifer C. Smith and Peggy J. Danneman

I. Introduction	171
II. Monitoring of the Anesthetized Patient	172
A. Core Components	172
B. Monitoring Techniques	174
III. Special Circumstances	180
A. Unique Challenges of Laboratory Animals	180
B. Monitoring of Neuromuscular Blockade in Anesthesia	180
IV. Summary and Conclusions	181
Acknowledgement	181
References	181

I. INTRODUCTION

Anesthesia can have unpredictable effects on the patient's normal homeostasis. Thus, it is safe to assume that any animal undergoing an anesthetic procedure will have its normal physiologic compensating mechanisms impaired in some way. These impairments register as changes in the body's normal physiologic states and provide the basis of anesthetic monitoring. Anesthetic monitoring allows one to recognize the extent of compromise to each body system during the course of a procedure and to make adjustments in the anesthetic protocol to prevent untoward short- and long-term effects on the animal.

Many variations can be expected in the way a patient will respond to anesthetic agents. These variations are affected by the patient's health/pathology, metabolism, and uptake/distribution of the anesthetic agents being delivered. In order for anesthetic

monitoring to be successful, three basic processes should occur: early recognition of homeostatic disturbances, the correct interpretation of changes, and appropriate intervention.

The first principle of anesthetic monitoring is to assure that the level of surgical anesthesia is consistent with the welfare of the animal. This requires monitoring anesthetic influence on the central nervous system (CNS), more commonly referred to as the depth of anesthesia. In addition to the danger of excessive depth of anesthesia, an animal in an adequate plane of anesthesia may become significantly compromised because of the direct depressant effects of particular anesthetic drugs on the cardiovascular or respiratory system. Many anesthetic-induced changes in the CNS, cardiovascular, or pulmonary system are gradually progressive over time rather than sudden events (with the exception of anesthetic induction); therefore, monitoring the appropriate parameters should allow for early

recognition of negative trends while physiologic disturbances are still reversible.

The second principle of anesthetic monitoring involves the correct interpretation of complications. When an animal is anesthetized its physiologic processes are altered by the anesthetic itself, the surgery being performed, and/or the research manipulations required by the study. If an animal appears compromised during a procedure, one must be able to determine quickly the likely cause of the problem in order to choose the appropriate steps to correct it. A thorough knowledge of the anticipated effects of different anesthetic drugs on each physiological parameter will make this interpretation of cause and effect much easier. The reader is referred to other chapters in this text in which the specific pharmacology and expected physiological effects of each anesthetic agent are discussed in detail. In addition to pharmacologically induced complications, physiologic status may be further compromised by complications related to procedural manipulations (i.e., severe blood loss and nerve injury).

The third principle of anesthetic monitoring involves intervention. Because regular anesthetic monitoring indicates deterioration of the patient before it becomes irreversible, the anesthetist is able to make adjustments in the anesthetic level, provide supportive therapy, or institute drug therapy that can positively affect outcome. The appropriate intervention is based on interpretation of the cause of the underlying problem.

II. MONITORING OF THE ANESTHETIZED PATIENT

A. Core Components

The American College of Veterinary Anesthesiologists (ACVA) has developed a set of guidelines for anesthetic monitoring in veterinary patients (ACVA, 1995). These guidelines include monitoring of circulation, oxygenation, and ventilation, as well as the use of an anesthetic record and appropriate personnel training. Although not applicable to all laboratory animals, these guidelines are a good suggested starting point for building monitoring paradigms. A summary of these suggested guidelines can be found in Table 6-1.

1. *Observation and Evaluation*

The techniques used in monitoring range from the use of sophisticated electronic equipment to simple visual and tactile observation. Mechanical and electronic devices enhance patient monitoring and are very useful in the laboratory setting where the anesthetist often has other duties, including that of a surgeon. Further, some parameters can only be monitored using

sophisticated equipment and these become especially important in high-risk patients or procedures. This equipment can also provide numerical data which may be necessary for the interpretation of research results. Despite all the advantages of such sophisticated equipment, it is crucial that anesthetists not neglect their senses as well as clinical observations. The senses are simple and reliable, rarely malfunction or require calibration, and do not need an emergency backup power generator. The importance of the use of the senses is a theme throughout the discussion of anesthetic monitoring.

In addition, the efficacy of anesthetic monitoring depends on the choice of physiologic variables that are studied. Certain parameters, such as withdrawal response to a toe pinch, are not very sensitive indicators of patient status. While the presence of a withdrawal in response to toe pinch would indicate that an animal is too light under anesthesia, the absence of withdrawal could be seen in an adequately anesthetized animal or one that is dangerously over-anesthetized. Alternatively, quantitative variables like blood pressure (BP) give numerical information that can be easily compared to previous readings, to indicate trends in patient status. It is also important that an anesthetist never rely on just one single parameter to monitor patient status. A single parameter, such as respiratory rate, may allow one to recognize trends during anesthesia; however, it can often be misleading when it comes to correct interpretation of cause and effect, therefore resulting in inappropriate treatment measures.

2. *Vital Signs*

In the anesthetized patient, vital signs are considered as those basic elements that can be easily monitored by the anesthetist's senses. Although specialized equipment can serve as an adjunct to monitoring vital signs, a trained anesthetist should be able to rely on their own senses (touch, sight, and hearing) to assess the anesthetized patient. The vital signs that should be monitored during anesthesia of larger laboratory animals include: heart rate (HR) and rhythm, pulse pressure, capillary refill time (CRT), mucus membrane color, blood loss, respiratory rate, and temperature (McKelvey and Hollingshead, 2003). For smaller laboratory animals (like rodents), adaptation of these techniques may be necessary.

3. *Anesthetic Depth*

The single most important concept of anesthetic monitoring is the assurance that the depth of anesthesia is consistent with the welfare of the patient. The depth of anesthesia required for an animal is determined by the type of procedure being performed and the response of the patient to the surgical stimulus. The depth of anesthesia required for a particular procedure also varies with the species of the animal. Some species, such as sheep, are far more tolerant of manipulation than others, such

TABLE 6-1

ACVA SUGGESTIONS FOR MONITORING ANESTHETIZED VETERINARY PATIENTS (AMERICAN COLLEGE OF VETERINARY ANESTHESIOLOGISTS, 1995)

Circulation*Objective:* To ensure that blood flow to tissues is adequate.*Methods:* (1) Palpation of peripheral pulse; (2) palpation of heartbeat through thoracic wall; (3) auscultation of heartbeat (stethoscope, esophageal stethoscope, or other audible heart monitor); (4) electrocardiogram (continuous display)^{a,b}; (5) noninvasive blood flow or BP monitor (e.g., Doppler ultrasonic flow detector and oscillometric flow detector)^{a,b}; and (6) invasive blood pressure (IVBP) monitor (arterial catheter connected to transducer/oscilloscope or to aneroid manometer).^b**Oxygenation***Objective:* To ensure adequate oxygen concentration in the patient's arterial blood.*Methods:* (1) Observation of mucous membrane color; (2) pulse oximetry (noninvasive estimation of hemoglobin saturation); (3) oxygen analyzer in the inspiratory limb of the breathing circuit; (4) blood gas analysis (PaO₂); and (5) hemoximetry (measurement of hemoglobin saturation in the blood).**Ventilation***Objective:* To ensure that the patient's ventilation is adequately maintained.*Methods:* (1) Observation of thoracic wall movement; (2) observation of breathing bag movement; (3) auscultation of breath sounds; (4) audible respiratory monitor; (5) respirometry (measurement of tidal volume +/- minute volume); (6) capnography (measurement of CO₂ in end-expired gas); and (7) blood gas monitoring (PaCO₂).**Anesthetic record***Objective:* To maintain a legal record of significant events and to enhance recognition of trends in monitored variables.*Methods:* (1) Record all drugs administered to each patient, noting the dose, time, and route of administration; and (2) record monitored variables (at least HR and respiratory rate) on a regular basis (at least every 10 minutes) during anesthesia.**Personnel***Objective:* To ensure that a responsible individual is aware of the patient's status at all times during anesthesia and recovery, and is prepared either to intervene, when indicated, or to alert the veterinarian in charge about changes in the patient's condition.*Methods:* (1) If a veterinarian, technician, or other responsible person is unable to remain with the patient continuously, a responsible person should check the patient's status on a regular basis (at least every 5 minutes) during anesthesia and recovery; (2) a responsible person may be present in the same room, although not necessarily solely occupied with the anesthetized patient (for instance, the surgeon may also be responsible for overseeing anesthesia); (3) in either of the aforementioned situations, audible heart and respiratory monitors are suggested; and (4) a responsible person, solely dedicated to managing and caring for the anesthetized patient during anesthesia, remains with the patient continuously until the end of the anesthetic period.^{a,b}^aRecommended for all patients assessed to be ASA status III, IV, or V.^bRecommended for horses anesthetized with inhalation anesthetics and/or horses anesthetized for longer than 45 minutes.

as the rabbit. The type of procedure will determine the intensity of the stimulation. High-intensity painful procedures, such as joint capsule incision, periosteal stimulation, fracture manipulation, visceral or peritoneal traction, diaphragmatic stimulation, corneal manipulation, or the manipulation of inflamed tissue will require a deeper level of anesthesia than less painful procedures. Because different pain intensities occur within a procedure as different tissues are manipulated, the anesthetist must frequently reassess and adjust the depth of anesthesia as is appropriate. Experience with a procedure will allow the anesthetist to anticipate necessary changes in the depth of anesthesia. Observational techniques that help indicate depth of anesthesia include the level of muscle relaxation, reflex activities, and physiologic responses to surgical stimulation.

A good assessment of muscle relaxation can be made by monitoring jaw tone in certain species. The ease of monitoring jaw muscle tone varies with species due to the differences in jaw size

and masseter muscle strength. Jaw tone is easily assessed in certain small animal species such as dogs and cats. It is much more difficult to evaluate in rodents, sheep, and swine. Although it is usually desirable to maintain some degree of muscle tone during anesthesia, if an animal attempts to close its mouth when gentle traction is placed on the mandible during a procedure, more anesthesia is generally needed.

Purposeful movement has traditionally been thought of as an indication that anesthesia is too light, and the animal is responding to a painful stimulus. The traditional view is that purposeful movement in response to surgical manipulation must be differentiated from spontaneous movement which can be seen with certain anesthetic agents such as ketamine, opioids, enflurane, and methoxyflurane and which does not occur in response to a surgical stimulus. The pedal withdrawal reflex is commonly used to help determine the level of surgical anesthesia in small laboratory animals. The pinnae of rabbits or rodents are often

tested in a similar manner, looking for head shaking in response to a painful stimulus. It has recently been suggested that purposeful movement as an assessment of depth of anesthesia alone is not adequate (Antognini et al., 2005). This theory has not been widely accepted and thus should be used with caution in the assessment of anesthetic depth.

Ocular reflexes can be used to indicate anesthetic depth. These include palpebral response, ocular position, and corneal reflex. The palpebral response is the blinking that occurs when the edge of the eyelid is lightly touched. There is species variation in this response under anesthesia. Most animals lose the palpebral response fairly early in surgical anesthesia; however, rabbits may maintain a palpebral response even at deeper planes of anesthesia. The intensity of the palpebral response is also influenced by the particular anesthetic agent used. The palpebral response is lost early with barbiturates and most inhalation agents; however, it is well maintained with ketamine.

Ocular position is generally a reliable sign of changing anesthetic depth in many species. As anesthesia is induced and in light planes of anesthesia the eyeball remains central in the orbit and the palpebral response is present. Nystagmus and lacrimation are also indications of a light plane of surgical anesthesia. When a surgical plane of anesthesia is reached, the globe rotates ventromedially. As anesthesia deepens (and muscle relaxation continues to increase), the globe will again rotate upward and return to a central position in the orbit. A centrally located globe during a deep plane of anesthesia can be distinguished from the centrally located globe of light anesthesia by the absence of the palpebral response during increased anesthetic depth. The corneal reflex is another ocular reflex that changes with the changing depth of anesthesia. To determine the presence of a corneal reflex, the surface of the cornea is lightly touched and the presence or absence of a blinking response noted. A brisk corneal reflex is found in awake animals and its intensity begins to diminish as the plane of anesthesia deepens. Certain species, such as ruminants, will maintain a corneal reflex during a surgical plane of anesthesia, whereas the reflex is often absent at a surgical plane in other species, such as the dog or cat.

Various physiologic responses to stimuli are also used to assess the level of surgical anesthesia. Increases in HR, BP, and/or respiratory rate can be seen in response to surgical stimulation when no purposeful movement has been observed. Changes in HR, BP, and respiratory rate are also affected by the specific drugs given and the physiologic state of the animal. An accurate interpretation of the cause of such autonomic responses requires an understanding of predicted cardiopulmonary responses to the pharmacologic agents being used in the animal, combined with an evaluation of anesthetic depth based on CNS signs. Again, no single parameter that can be monitored is solely adequate to pinpoint accurately the plane of anesthesia in an anesthetized animal.

All of the above information on anesthetic depth should be considered when formalizing a proper anesthetic monitoring plan to assure the best possible anesthetic outcome.

B. Monitoring Techniques

The key body systems responsible for the short-term well-being of an animal during anesthesia and surgery consist of the cardiovascular, respiratory, and central nervous systems. All of these systems are markedly affected by anesthesia when the normal homeostatic mechanisms that influence their function are disturbed. Anesthetic monitoring allows one to recognize the extent of compromise to each body system during the course of a procedure and to make adjustments in the anesthetic protocol to prevent untoward long-term effects in the animal.

Today's anesthetist can utilize specialized monitoring equipment as an adjunct to their routine observational skills. Physiologic data relating to the cardiovascular, respiratory, and central nervous systems can all be collected and recorded using common monitoring equipment (Fig. 6-1).

1. Cardiovascular System Monitoring

Most anesthetic agents cause a dose-dependent depression of the cardiovascular system. Therefore, monitoring of this system

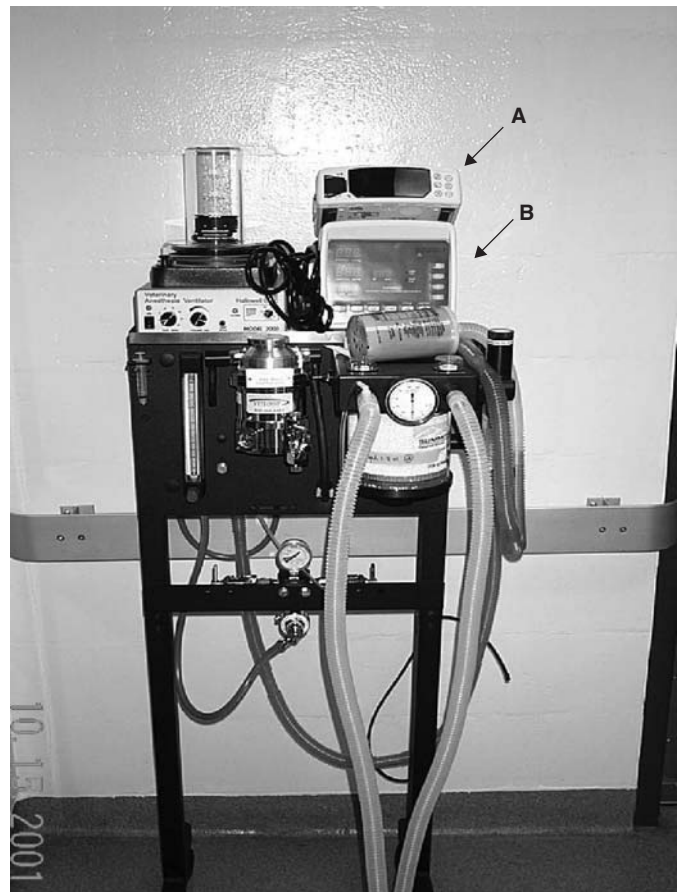

Fig. 6-1 Typical anesthesia monitoring equipment used in the laboratory environment. (A) Pulse oximetry, ECG, and capnography. (B) NIBP and HR.

provides not only an assessment of circulatory function, but also additional information on the depth of anesthesia.

a. Heart Rate

HR is important for the effect it has on overall cardiac output (CO). CO is the product of HR and stroke volume. HR is often influenced by the depth of anesthesia, such that bradycardia frequently occurs as the anesthetic plane gets deeper and tachycardia occurs when the anesthetic plane is too light. The definition of bradycardia and tachycardia is species-dependent, so at the outset of anesthesia one should be aware of the normal range of HR for the particular species that is being studied. The importance of not relying solely on one parameter while monitoring is well illustrated by HR. Tachycardia can be caused by painful surgical stimulation in a lightly anesthetized animal, and increasing the plane of anesthesia is often indicated in this case. However, hypotension, hypovolemia, hypoxia, hyperthermia, and hypercarbia are also potential causes of elevated HR and increasing the level of anesthesia would not be indicated for these causes. Determination of the actual cause of the tachycardia requires examination of other monitored information. Bradycardia may be caused by specific anesthetic drugs (i.e., opioids and alpha-2-agonists), reflex activity (i.e., mesenteric traction, intubation, oculocardiac reflex, and hypertension), hypothermia, hyperkalemia, or cardiac conduction disturbances. If anesthetic depth is determined to be appropriate, bradycardia may be treated by anticholinergics. Anticholinergics would be the treatment of choice for bradycardia caused by opioids, xylazine, vagal reflex activity, and certain cardiac conduction disturbances. Bradycardia secondary to hypothermia is unresponsive to anticholinergics and requires rewarming of the animal for improvement. Bradycardia as a result of hyperkalemia represents a serious disturbance in cardiac conduction, and emergency steps to reduce serum potassium need to be instituted.

b. Pulse

Pulse strength and regularity are usually determined by the digital palpation of the pulse from an accessible site (i.e., femoral artery, lingual artery, auricular artery, or tail artery). Palpation of the pulse is helpful in assessing mechanical activity of the heart. Palpation can reveal the presence of an arrhythmia and, based on the subjective assessment of the pulse strength, can provide some information relating to adequacy of the CO. It is important to realize when interpreting pulse strength that the intensity of the palpated pulse is a function of the magnitude of the pulse pressure. Pulse pressure is the numerical difference between the systolic and the diastolic arterial blood pressures. The larger the systolic/diastolic difference, the stronger the pulse feels. A large systolic/diastolic difference resulting in good pulse strength does not always indicate an adequate tissue perfusion. Once again, relying only on a single parameter—in this case the pulse strength—could be misleading, and therefore

other parameters need to be used to confirm adequate cardiovascular function. Although a good pulse is not always an absolute indication that all is going well during anesthesia, the absence of a palpable pulse should always be considered a sign of inadequate cardiovascular function. Furthermore, it is important to note that the detection of a digital pulse in smaller laboratory animals (rodents) is not always easy or possible.

c. Capillary Refill Time

The time it takes for the mucous membrane color to return to normal after releasing digital pressure applied to the membrane sufficient to blanch it of color is defined as CRT. Normal CRT should be less than 2.5 seconds. CRT is considered as an indicator of peripheral perfusion, and a prolonged CRT is seen during hypotension or low CO states. It is important to realize, however, that CRT is markedly influenced by arteriolar tone. A number of conditions causing peripheral arterial vasoconstriction will prolong CRT even though overall tissue perfusion is likely adequate. Pain, excitement, hypothermia, and certain drugs (i.e., xylazine) induce vasoconstriction and can increase CRT above the acceptable upper limit. On detecting a prolonged CRT, other monitoring parameters must be examined in order to determine its significance.

d. Electrocardiography

Electrocardiography (ECG) is a technique that provides important information during the course of anesthesia. An ECG is widely applicable to most large species, and sometimes used in smaller laboratory animals. Many ECG monitors provide a continuous readout of HR. When attached to a recording device, ECG monitors allow continuous or intermittent accumulation of HR and rhythm data at different stages of an experiment. In addition, an ECG is the only way to establish the diagnosis of arrhythmias that might occur as a result of anesthesia or surgical manipulations. The major shortcoming of ECG as a monitoring tool is that it represents only cardiac electrical activity and does not provide an assessment of the CO or tissue perfusion, which are the more important functional aspects of cardiovascular performance.

The ECG of most species consists of a set of waves, including the P wave that indicates atrial depolarization and the T wave that represents ventricular repolarization. The shape, size, and timing of each of these waves are dependent on the species and the particular lead system that is being used. For diagnostic purposes in an individual with suspected cardiac disease, a multilead system (12 lead) is frequently used. During monitoring of anesthesia, the ECG mostly serves as an HR and rhythm monitor, and therefore a single lead system (i.e., lead II with reference electrodes attached at right forelimb and left hind limb) is often used. In small laboratory animal species, the electrical signal is small (low millivoltage), as are the amplitudes of the ECG waves. In addition, the HR is relatively rapid, sometimes making

it difficult to discern anything other than the QRS complex on the ECG. Despite this situation, the ECG can still be useful in these smaller species as an indicator of HR, and an irregular P-R interval, or changes in the shape of the QRS complex, can be a useful indicator of the development of arrhythmias. The recognition of the type of arrhythmia usually determines the appropriate treatment; consultation of a comprehensive cardiology text is recommended (Tilley, 1992).

e. Arterial Blood Pressure

The measurement of arterial BP can be very helpful in determining the adequacy of cardiovascular function during anesthesia. The majority of anesthetic agents will cause a dose-dependent depression of BP through their effects on CO, vascular tone, or both, and, therefore, a trend of progressively decreasing BP may be an indication of excessive anesthetic depth. However, to accurately interpret the significance of changes, one must take into account the varied factors that influence BP. Factors that contribute most notably to BP are CO, peripheral vascular resistance (PVR), and blood volume. Analogous to Ohm's law, which applies to electrical current, pressure is equal to flow times resistance, such that $BP = CO \times PVR$. If CO and/or PVR increase, so will arterial BP. If CO decreases, by way of direct anesthetic depression of the myocardium or decreased filling pressures due to loss of blood volume, without a compensatory increase in arteriolar tone, the BP will fall.

The actual significance of arterial BP is, as a component of tissue perfusion pressure, a determinant of tissue blood flow. The upstream (arterial) pressure must significantly exceed the downstream (venous) pressure to enhance the flow through tissue capillary beds. The perfusion pressure should be greater than 60 mmHg for adequate tissue perfusion (Haskins, 1987). Therefore, in monitoring arterial BP, a mean BP less than 60 mmHg is considered unacceptable for maintaining tissue blood flow. Mean BP is not the mathematical mean of the systolic and diastolic blood pressures. Rather, it can be estimated from the measured systolic and diastolic pressures by the following equation: $mean\ BP = diastolic\ BP + 0.3\ (systolic\ BP - diastolic\ BP)$.

To obtain BP ideally, a direct arterial catheter can be used, and through the use of a pressure transducer, accurate systolic, diastolic, and mean blood pressures are determined. Because of the invasive nature of this technique, the difficulty in placing arterial catheters in many species, and the expense of the electronic monitor, estimates of direct arterial blood pressures are not always available. There are, however, two reasonable noninvasive alternatives to indirect BP monitoring: the oscillometric monitor and the Doppler ultrasonic BP monitor. Although both of these devices are versatile and very useful in the clinical setting, there are some limitations to their use. Small patient size, extremes of HR (<40 or >200 bpm), significant hypotension, and hypothermia (through peripheral vasoconstriction) may all

interfere with the accuracy of the pressures obtained with either of these methods. However, a recent paper by Krege (2005) reports useful adaptations to oscillometric BP monitors that can be used in the laboratory animal setting.

Oscillometric monitors generally report a measured systolic and mean BP and extrapolate a diastolic BP (Geddes, 1984a). Oscillometric devices also report HR, which can be used as an index of the accuracy of the reported pressures. A rule of thumb for accuracy is that pressure values should be questioned when a pressure reading from the monitor is accompanied by a reported HR that varies more than 10% from the actual HR as determined by auscultation or palpation of pulses.

The Doppler ultrasonic monitor gives systolic BP only. As a rule, a systolic BP > 100 mmHg is accompanied by adequate tissue perfusion. A major advantage of the Doppler monitor is that it also transmits a pulse sound signal through a speaker device. This audible signal can be used to count HR, and indicates that there is functional cardiac activity adequate enough to generate a peripheral pulse. In addition, although subjective, changes in intensity of the audible signal correlate with changes in CO (Dyson et al., 1985). If the audible Doppler signal becomes diminished, one should quickly examine other parameters of hemodynamic status. Doppler monitors are useful in virtually all species, although in small species they are primarily used as pulse monitors, with the probe placed on the chest wall directly over the cardiac apex.

f. Central Venous Pressure

Central venous pressure (CVP) is measured directly by insertion of a catheter through the anterior vena cava to the level of the right atrium. This catheter is then connected to a fluid manometer, where the pressure reading can be read. Thus, the CVP value reflects the pressure in the right atrium and is an index of cardiac filling pressure. The CVP value allows the anesthetist to assess how well the blood is returning to the heart, which is helpful in right-sided heart failure patients. The factors that influence the CVP are the volume of the blood in the central veins, the compliance of the right atrium during filling, the central vein vascular tone, and the intrathoracic pressure.

g. Pulmonary Artery Pressures and Cardiac Output

The standard method of obtaining CO data during anesthesia is through measurements of pulmonary blood flow by thermodilution. The Swan-Ganz catheter is a balloon-tipped, flow-directed device equipped with a thermistor tip for measuring the change in blood temperature after injection of cold solution (Dorsh and Dorsh, 1999). This device is passed into the pulmonary artery (PA) via the jugular vein-right atrium-right ventricle route and confirmation of correct placement is usually made by observation of characteristic changes in the pressure waveform during its passage (Geddes, 1984a). The Swan-Ganz catheter allows measurement of CO, systolic, diastolic, and

mean PA pressures, as well as pulmonary artery occlusion pressure (PAOP, also called "wedge" pressure), which is obtained upon inflation of the balloon tip, impeding PA blood flow, and reflecting left atrial pressure. Normal values in many species for PA pressures are: systolic, 20–40 mmHg; mean, 10–20 mmHg; diastolic, 5–10 mmHg; and PAOP, 3–8 mmHg. PA catheters are indicated for mixed venous blood gas sampling, measurement of CO, monitoring for left-sided cardiac insufficiency, and pulmonary hemodynamics. Because much of the hemodynamic data obtained from PA catheters involve calculation of derived variables (i.e., vascular resistances and ventricular stroke work index), PA catheters are used more often in the experimental setting for the collection of study-specific data rather than for anesthetic monitoring per se; however, the information gained from the catheter is often useful for making future anesthetic determinations.

2. Respiratory System Monitoring

The major function of the respiratory system, in either an awake or anesthetized animal, is to act as a gas exchange organ. The lung is responsible for the introduction of oxygen into the arterial blood (oxygenation) and the elimination of carbon dioxide from the body (ventilation), and the uptake and elimination of gas anesthetics when inhalation anesthesia is used. To evaluate respiratory function, both oxygenation and ventilation must be assessed. It is important to monitor the respiratory system during anesthesia not only because of its life-sustaining importance, but also because many anesthetic agents suppress respiratory control mechanisms; respiratory arrest usually precedes cardiovascular collapse when excessive anesthesia occurs.

Observational techniques allow one to assess respiratory frequency, rhythm, and volume as well as mucous membrane color. Each of these parameters alone provides little information of the adequacy of ventilation and oxygenation. However, when viewed collectively these parameters are advantageous in indicating the state of respiratory function.

a. Respiratory Rate

This rate can be determined by visual observation of the animal, looking at chest wall motion, by auscultation of the thorax, or by observing the rebreathing bag on the anesthetic machine. There are species variations in the range of normal respiratory rates and one should be familiar with these values prior to anesthetizing any animal. In particular, in smaller laboratory animal species (rodents), it can be difficult to visually assess respiratory rate. Usually, the higher the basal metabolic rate (and CO₂ production) of the animal, the higher the resting respiratory rate. Most anesthetics are respiratory depressants and, as a general rule, the respiratory rate decreases with an increasing anesthetic depth.

b. Mucous Membrane Color

Cyanosis is the discoloration of mucous membranes that results from reduced hemoglobin in the blood, imparting a purplish cast to the tissue. Cyanotic mucous membranes are not seen until 5 g/dl of hemoglobin in the blood becomes unoxygenated (Allen, 1991). In anemic states, when the blood hemoglobin concentration is low, hypoxemia can be quite severe even though cyanosis is not evident. Therefore, the appearance of cyanotic mucous membranes indicates hypoxemia, but a lack of visible cyanosis does not mean that the animal is adequately oxygenated.

c. Tidal Volume

The amount of gas entering the respiratory tract during one respiratory cycle is called the tidal volume. An average tidal volume for most species is about 10 ml/kg; however, there can be wide variations among species. Monitoring tidal volume is usually subjectively based on the degree of chest wall motion with each breath or the amount of movement in the rebreathing bag of the anesthetic machine. It is important to realize that monitoring chest wall motion alone tells little about the actual volume of gas inhaled, as an animal with an airway obstruction or restrictive pulmonary disease often has marked chest wall motion with little air movement, with the chest wall motion reflecting a high work of breathing in this case. In certain species, such as ruminants, rabbits, and guinea pigs, with the potential to develop abdominal distension secondary to gas accumulation in their gastrointestinal tract, close attention should be paid to respiratory effort and tidal volume because abdominal distension can be a significant cause of respiratory insufficiency. Evaluation of other parameters such as concurrent change of volume in the rebreathing bag can be beneficial to help confirm adequate tidal volume. The volume of gas in each respiratory cycle can be measured by attaching an instrument called a respirometer to the endotracheal tube (Lumb and Jones, 1996).

d. Minute Ventilation

Respiratory rate and respiratory volume are determined as an indication of the minute ventilation of the animal. Minute ventilation is the product of respiratory rate and tidal volume. The adequacy of ventilation is judged by the effectiveness of the lung in removing carbon dioxide from the pulmonary capillary blood and is directly linked to minute ventilation. The partial pressure of carbon dioxide in the arterial blood is inversely proportional to minute ventilation, such that if metabolism (CO₂ production) remains constant, doubling the minute ventilation decreases PaCO₂ by one-half. The partial pressure of CO₂ in arterial blood is the major stimulus for ventilation in the respiratory control center in the brain, where anesthetics exert their respiratory depressant effect (increased threshold and decreased sensitivity to CO₂) (Nunn, 1987). Decreasing minute ventilation during

anesthesia may reflect a decrease in CO₂ production (often seen with hypothermia) or it may reflect increased depression of the respiratory control centers from the anesthetic drugs. An elevation in PaCO₂ (above 60 mmHg) indicates the need for increased minute ventilation, through an increase in respiratory rate, volume, or both, and may also indicate the need to decrease anesthetic depth.

e. Capnography

The concentration of carbon dioxide in the inspired and expired gas can be continuously measured from the airway using capnography. The capnograph samples airway gas from a port located either at the endotracheal tube/breathing circuit interface or from a site at the distal end of the endotracheal tube. The capnograph measures the CO₂ in the inspired and expired air that passes through the monitor and displays it in graph form (the capnograph). Inspired gas should contain virtually no carbon dioxide. As an animal exhales and alveolar emptying occurs, carbon dioxide appears in the exhaled gas. The peak expired CO₂ is a reflection of the partial pressure of CO₂ in alveolar gas, which is equilibrated with arterial blood (Moens and Versraeten, 1982). Therefore, increased values suggest hypoventilation whereas low peak expired CO₂ suggests hyperventilation. The peak expired (i.e., end-tidal) CO₂ may tend to underestimate the PaCO₂ because the gas sampling flow rate of the machine is high enough that gas (containing virtually no CO₂) is entrained from the breathing circuit, diluting the end-tidal sample (Dorsch and Dorsch, 1984). In addition to ventilatory information, a capnograph can be useful in the rapid detection of endotracheal tube malfunctions, such as disconnection from the circuit or a kinked or obstructed tube. Capnographs have also proven to be sensitive early indicators of the development of malignant hyperthermia in susceptible species (primarily swine) in which a rapid rise in end-tidal CO₂ reflects the marked metabolic increase in CO₂ production that precedes the often fatal increase in body temperature (Bagshaw et al., 1978).

f. Pulse Oximetry

A pulse oximeter is an instrument that by means of a light source and photo detector measures the light absorbance of tissues and indicates the level of oxygen saturation of hemoglobin in the blood. Oxygen saturation of hemoglobin (SaO₂) is related to the partial pressure of oxygen in arterial blood such that for each value of PaO₂ there is a corresponding percentage of hemoglobin that is saturated with oxygen. Adequate arterial oxygenation requires a minimum PaO₂ value greater than 60 mmHg (and ideally >90 mmHg). A PaO₂ of 60 mmHg corresponds to a 90% saturation of the hemoglobin in the arterial blood. Using a pulse oximeter, changes in hemoglobin saturation can be monitored continuously. When the SaO₂ value falls below 90%, the animal becomes hypoxemic and steps should be taken to improve oxygenation, such as administering 100%

oxygen, endotracheal intubation, and/or assisted ventilation as indicated (Clark et al., 1992). There are also a number of conditions that produce erroneously low oximeter values. Because the pulse oximeter is highly dependent on good peripheral perfusion, hypotension and hypothermia will impair accuracy. Motion artifacts (i.e., patient movement or shivering) and bright external light sources (i.e., fluorescent lights, surgery lights, and heat lamps) will interfere with the probe's ability to detect signal (Severinhaus and Kelleher, 1992). In addition to reporting SaO₂, the pulse oximeter often gives a value for the HR. If the HR value, as reported, varies significantly from the actual HR obtained by palpation, then the accuracy of the reported SaO₂ should be questioned. Pulse oximeter probes work best when placed on nonpigmented, hairless tissues such as the tongue.

g. Blood Gas Analysis

Although the above-mentioned techniques can provide the anesthetist with respiratory system information, the only absolute way to effectively judge the adequacy of ventilation and oxygenation in any animal is through arterial blood gas analysis. This analysis is carried out on an arterial blood sample, which must be stored on ice and analyzed within 2 hours of collection. The partial pressure of CO₂ in arterial blood should fall between 35 and 45 mmHg. A PaCO₂ < 35 mmHg is defined as hyperventilation, which most often occurs iatrogenically in animals that are being ventilated. A PaCO₂ > 45 mmHg is, by definition, hypoventilation and, depending on the experimental conditions, may also indicate the need for assisted ventilation. If an animal has a PaCO₂ above 60 mmHg during anesthesia, steps should be taken immediately to improve ventilation, which may include endotracheal intubation, manual or mechanical ventilation, or decreasing the level of anesthesia as indicated. A partial pressure of oxygen in the arterial blood >90 mmHg assures adequate oxygenation (provided there is adequate tissue perfusion). Much higher levels of PaO₂ are often expected during anesthesia depending on the percentage of oxygen in the inspired gas. As a rule, the PaO₂ should be approximately five times the inspired oxygen concentration so that when breathing 100% oxygen the arterial PaO₂ should approach 500 mmHg. An animal may be relatively hypoxemic in that its PaO₂ is less than that would be expected for the particular inspired oxygen concentration. This can indicate concurrent hypoventilation (check the PaCO₂), ventilation-perfusion mismatching, shunt, or diffusion impairment. Absolute hypoxemia with significant impairment of tissue oxygenation occurs at PaO₂ values <60 mmHg (Shapiro et al., 1982). When PaO₂ falls to that level, measures should be taken to improve oxygenation, such as maximizing the inspired oxygen concentration and improving ventilation.

h. End-tidal Anesthetic Concentration

An adjunct to monitoring anesthetic depth is monitoring the end-expiratory (end-tidal) inhalation agent concentration during

the anesthetic procedure. As described with capnography, the end-expiratory concentration of an inhalation agent is assumed to be reflective of the arterial and brain concentration of the agent being monitored. Typically, surgical anesthesia is achieved at 1.2–1.5 times the minimum alveolar concentration (MAC) of an inhalation agent (Steffey, 1984). As an example, the MAC of halothane in the dog or cat is 0.87%. Surgical anesthesia would therefore be achieved at an end-tidal halothane concentration of 1.04–1.31%. An end-tidal inhalation agent monitor will indicate if the alveolar concentration of gas is in the proper range and, in combination with observational signs of depth of anesthesia, will indicate if the animal is suitably anesthetized for a surgical procedure.

As with other parameters, using end-tidal agent concentration as the sole indicator of anesthetic depth can lead to erroneous conclusions. The administration of other anesthetic drugs, especially opioids or alpha-2 agonists, that have significant analgesic properties, will allow an animal to be adequately anesthetized at anesthetic concentrations much less than 1.5 times MAC. Hypothermia can also markedly decrease the MAC of inhalation agents, so relying on end-tidal concentration alone without observing additional signs in the animal may lead to inappropriately deep planes of anesthesia. It is important to recognize that the end-tidal gas concentration necessary to achieve surgical anesthesia is not the same thing as the concentration setting on the vaporizer. During the induction and equilibration phase of inhalation anesthesia, there can be a large difference between the vaporizer concentration and the end-tidal value (the vaporizer concentration being higher at the beginning of anesthesia). With time, the difference between these two concentrations narrows. Monitoring end-tidal agent concentrations can serve as a useful guide for when to decrease or increase the setting on the vaporizer, is often necessary in a research setting to quantitatively establish the dose of drug delivered.

3. CNS Monitoring

Anesthesia directly suppresses the homeostatic control systems within the body, most of which arise from, or channel information through, the CNS. Anesthesia suppresses the level of consciousness, pain perception, muscle tone, and reflexes, all of which result primarily from anesthetic drug activity on the CNS. The basis of our ability to control the effects of anesthesia depends on being aware of the impact the drugs are having within the CNS at any given moment. An awareness of the level of anesthetic-induced CNS depression requires monitoring signs in body systems that reflect the level of input from the CNS.

a. Thermoregulation

Most anesthetic procedures cause a depression of the hypothalamic thermoregulatory mechanism, predisposing animals to hypothermia. This is an even greater problem in

small laboratory animal species. These animals have a very large surface area relative to body mass, which causes a correspondingly greater loss of body heat. This is further compounded by the removal of hair and wetting the remaining hair coat during aseptic preparation of the surgical site. When this small damp animal is then placed on a cold metal surface, the result can be fatal hypothermia. Opening of a body cavity will further accelerate the loss of body heat. Body temperature is best monitored using a small thermistor placed into the esophagus to the level of the heart. This will provide a closer indication of core body temperature than other methods (Lumb and Jones, 1996). Clinical thermometers do not register continuous decrease in body temperature and thus are not recommended. Hypothermia can be minimized by the warming of surgical preparation solutions, insulating the patient from both cool ambient temperatures and a cold restraining surface, using warm fluids if supplemental fluids are provided, warming inspired gases, and using supplemental heat provided by a circulating water blanket or forced air warming systems (i.e., Bair-Hugger). An example of the latter device adapted for the laboratory animal environment is described in a recent article by Rembert et al. (2004). Electric heating pads should be avoided as they can cause serious thermal burns and even hyperthermia. Anesthetic-induced hyperthermia can be seen in some breeds of dogs and pigs. Because both hypo- and hyperthermia can enhance the effects of central depressant drugs, as well as confound experimental data, monitoring body temperature of the patient is particularly important in laboratory animals.

b. New Trends in CNS Monitoring

To date, several different methods to describe and monitor the potency of anesthetic agents and patient anesthetic depth in animals have been described. The Bispectral Index (BIS) is a newer technology utilizing a predetermined algorithm of human electroencephalography (EEG) activity to provide the anesthetist with immediate feedback on the patient's CNS activity, and therefore anesthetic depth. Basically, a number between 0 and 100 is derived from EEG data collected from the patient during anesthesia. A typical BIS value of 40–60 is used to prevent intraoperative awareness in human anesthesia. The use of BIS technology has been reported recently in animals (pigs, dogs, goats, and cats) (Antognini et al., 2000; Greene et al., 2004; Lamont et al., 2004; March and Muir, 2003); however, its accuracy has been questioned. It is generally agreed that the differences between the human and animal species account for most of these inaccuracies. Nonetheless, the BIS monitor can be considered a useful adjunct tool for anesthetic depth monitoring in animals. (See additional discussion of BIS below.)

Anesthetic depth as judged by the obliteration of any purposeful movement has also been discussed recently (Antognini et al., 2005). Complex movement patterns can occur during anesthesia and do not require connections with the cerebral cortex as once believed. Thus, it is concluded that these movements can

occur in properly anesthetized patients, and do not necessarily imply that the animal is awake. Although this could be an interesting development in anesthetic depth assessment, it should be used with caution to assure that the patient's welfare during anesthesia is always a priority.

III. SPECIAL CIRCUMSTANCES

A. Unique Challenges of Laboratory Animals

Monitoring of general anesthesia becomes more difficult when the patient size is reduced. The laboratory animal veterinarian is uniquely tasked with conducting anesthesia in a wide variety of species, most of which are small. The nature of their small body size makes routine techniques used to monitor anesthesia (i.e., manual pulse, observations of respiratory effort, etc.) difficult. To compensate for this, the use of creative techniques and modified equipment is often necessary to be able to follow the status of very small patients under anesthesia. Other equipment, such as a BP-monitoring device, is often impractical. However, modifications can sometimes be made in existing equipment to accommodate the smaller species used in the laboratory setting (Hagaman et al., 2005; Krege et al., 2005). Summary comments on anesthetic monitoring in the laboratory animal environment can be found in Table 6-2.

Further challenges facing the laboratory animal anesthetist are the necessity for physiologic stability for valid experimental data and accurate interpretation of research results. Anesthetics can have a profound effect on research results, and a well-documented anesthetic procedure is an important part of the experimental record. Data collected during anesthetic monitoring serve as the basis for design of subsequent anesthetic procedures.

The need to minimize pain and distress is an important aspect of all veterinary anesthesia, but the regulatory environment adds an additional dimension in the research setting. An anesthetic protocol, approved by the Institutional Animal Care and Use Committee, is the first step toward this goal, but anesthetic monitoring plays a role as the indicator of an animal's response to the procedure while under the influence of anesthetic drugs. When an animal responds to surgical manipulation, additional anesthesia is indicated and the anesthetic protocol designed for that study may need reexamination.

B. Monitoring of Neuromuscular Blockade in Anesthesia

Monitoring the depth of anesthesia in an animal that has been paralyzed with a neuromuscular blocking agent drug (NMBD) is both critically important and challenging. These drugs may cause paralysis of all skeletal muscles, including the intercostal

TABLE 6-2

SUMMARY COMMENTS ON ANESTHETIC MONITORING IN THE LABORATORY ANIMAL ENVIRONMENT

-
- Comprehensive and ongoing training program for *all* personnel conducting anesthesia
 - Pre-anesthetic physical exam and ASA classification^a as appropriate
 - Create appropriate anesthetic plan
 - Include current ASA classification^a
 - Consider research procedure
 - Consult previous anesthetic protocols/anesthetic records
 - Minimum monitoring should include
 - Heart rate/rhythm and pulse pressure
 - Respiratory rate and pattern
 - CRT/mucous membrane color
 - Temperature
 - Blood loss
 - Anesthetic record
 - Consult AVCA suggested plan^b
 - Anesthetic depth
 - Use a combination of observations
 - Consider traditional methods
 - Consider BIS EEG monitoring
 - Consider use of specialized monitors
 - NIBP and INBP
 - Pulse oximetry
 - Capnography
 - Peripheral nerve stimulator for NMB protocols
 - BIS
-

^aAmerican Society of Anesthesiologists (2007).

^bAmerican College of Veterinary Anesthesiologists (1995).

muscles and diaphragm, which are essential to respiration. In clinical doses, the NMBDs have virtually no CNS effects, and they provide no degree of anesthesia or analgesia. For this reason, the use of these agents to immobilize otherwise unanesthetized animals is condemned (PHS, 2000). They can be used humanely in anesthetized animals, provided that the animal is protected from experiencing pain while paralyzed. The problem is that many of the techniques that may be used to monitor pain perception in an anesthetized animal are useless in one that is also paralyzed.

A paralyzed animal cannot move in response to perception of painful stimulation, and most respiratory parameters cannot be assessed because the paralysis of the muscles involved in respiration requires that the animal be mechanically ventilated. Some investigators have used changes in end-tidal CO₂ as an indicator of pain perception in paralyzed animals. The premise is that catecholamines released in response to pain lead to increased CO₂ production (and concomitant increase in oxygen consumption) (Haskins, 1996; Sarton et al., 1997). However, hypercapnia is not a specific indicator of arousal or pain, as it may result from other conditions including hypoventilation, dead space rebreathing, or even increased muscle tone associated with waning of the neuromuscular blockade (Hall and Clarke, 1991; Haskins, 1996). HR, BP, and cardiac rhythm also can be monitored in paralyzed animals, but the anesthetist

must be aware that many NMBDs can cause arrhythmias and changes in BP or HR. Although cardiovascular effects are minimal with most of the newer NMBDs, such as atracurium and vecuronium, cardiovascular changes may be observed even with some of the newer drugs (Cullen, 1996; Gyermek et al., 2006; Sparr et al., 2001; Taylor, 1996). Accurate interpretation of any of these physiological parameters is facilitated if the animal is at an adequate and stable plane of anesthesia prior to administration of the paralytic agent. Changes in physiological parameters associated with administration of the agent should be noted, and subsequent changes viewed as possible indicators of altered depth of anesthesia or pain perception (Hartsfield, 1992; NRC, 2003). When consistent with the requirements of the experiment, allowing the anesthetized animal to recover periodically from the effects of the paralytic agent is desirable, in that it provides opportunities for a more thorough evaluation of anesthetic depth (NRC, 2003). This is not always practical, however, especially with the longer-acting drugs such as pipecuronium and doxacurium.

A more technically demanding measure that may be helpful in assessing adequacy of anesthesia is the BIS. BIS has been used as a means of monitoring depth of anesthesia in both humans and animals, including those paralyzed with NMBD. Bispectral analysis is a method of signal processing that involves complex Fourier (power) analysis of the EEG and quantitation of the degree of phase coupling between different components of the signal. The BIS is derived from the bispectral analysis combined with other features of the EEG such as the level of burst suppression (Sigl and Chamoun, 1994; Struys et al., 1998). While it does not appear that BIS is able to discriminate precisely between different depths of anesthesia, it may be a useful measure of awareness or arousal in anesthetized subjects—human or animal—under the influence of NMBD (Greene et al., 2004; Haga and Dolvik, 2002; March and Muir, 2003, 2005; Myles et al., 2004; Schneider et al., 2003).

In summary, there is no single technique or measure that can be used as a universally reliable indicator of insensitivity to pain in a paralyzed animal. The best approach involves consistent and careful monitoring of a variety of physiological parameters before and during neuromuscular blockade. Interpretation of any observed changes should be based on the pattern, as well as the knowledge of both the pharmacology of the drugs being used (anesthetics, NMBD, and other pharmacologic agents) and the species of animal being studied.

IV. SUMMARY AND CONCLUSIONS

Frequent evaluation of the physiologic status of an anesthetized animal leads to early recognition of homeostatic disturbances, facilitating timely and appropriate intervention to prevent anesthetic mishaps, and helping to provide a stable physiologic state consistent with the welfare of the patient and sound

experimental data. An accurate interpretation of monitoring data begins with the knowledge of what is normal for the animal species, and this should always start with a preanesthetic evaluation.

It is usually not feasible to monitor all possible parameters in every patient, so the anesthetist must choose those parameters that are most likely to change in response to anesthesia and surgery and will have an impact on the well-being of the animal and on the research itself. In order to achieve this, the anesthetist must have a basic knowledge of the physiological effects of the anesthetic agents to be used, the procedures to be performed, and the experimental manipulations and data to be collected as part of the experimental protocol. When a change in a monitored parameter occurs, the anesthetist must accurately determine the cause of that change. Monitoring several parameters, with serial data collected, allows trends to be observed that enable the anesthetist to tailor the anesthetic protocol to the response of the animal. This is important because systems interact with each other to create a physiologic state, and because interventions will likely affect more than one system. The systems requiring at least some degree of monitoring in all patients include the cardiovascular, respiratory, and central nervous systems.

Smaller laboratory animal species present additional challenges to the anesthetist in regards to anesthetic monitoring. Although their small size and blood volumes make frequent monitoring of certain parameters (i.e., blood gases) difficult, modifications can sometimes be made in the existing equipment to accommodate these smaller species.

The most successful anesthetic protocols, however, come with practice. To determine the best protocol for a given research or surgical procedure, it is helpful to have anesthetic monitoring records of past procedures. Such records assist the anesthetist in anticipating problems that might be encountered in future procedures. In addition, good monitoring records are always necessary for demonstrating consistency in experimental protocols and for eliminating variability that may invalidate the research data.

ACKNOWLEDGEMENT

In preparation of this chapter for this second edition, the authors wish to acknowledge D.E. Mason and M.J. Brown for their efforts in the preparation of Chapter 5 (Monitoring of Anesthesia) for the first edition of this text.

REFERENCES

- Allen, D.G. (1991). Cyanosis, pallor and erythema. In "Small Animal Medicine" (D.G. Allen, ed), pp 15–23. Lippincott, Philadelphia.
- American College of Veterinary Anesthesiologists. (1995). Suggestions for monitoring anesthetized veterinary patients. *JAVMA* **206**(7), 936–937. <http://www.acva.org/professional/Position/monitor.htm> (last accessed April 2007).
- American Society of Anesthesiologists. (2007). Classification of physical status. In "Relative Value Guide." <http://www.asahq.org/clinical/physicalstatus.htm> (last accessed April 2007).

- Antognini, J.F., Barter, L., and Carstens, E. (2005). Movement as an index of anesthetic depth in humans and experimental animals. *Comp. Med.* **55**(5), 413–418.
- Antognini, J.F., Wang, X.W., and Carstens, E. (2000). Isoflurane anaesthetic depth in goats monitored using the bispectral index of the electroencephalogram. *Vet. Res. Commun.* **24**, 361–370.
- Bagshaw, R.J., Cox, R.H., Knight, D.M., and Detweiler, D.K. (1978). Malignant hyperthermia in a greyhound. *J. Am. Vet. Med. Assoc.* **172**, 61–62.
- Clark, J.S., Votteri, B., Ariangno, R.L., Cheung, P., Eichhorn, J.H., Fallat, R.J., Lee, S.E., Newth, C.J.L., Rotman, H., and Sue, D.Y. (1992). Noninvasive assessment of blood gases. *Am. Rev. Resp. Dis.* **145**, 220–232.
- Cullen, L.K. (1996). Muscle relaxants and neuromuscular block. In “Lumb & Jones’ Veterinary Anesthesia” (J.C. Thurmon, W.J. Tranquilli, and G.J. Benson, eds.), 3rd ed., pp 337–364. Williams & Wilkins, Baltimore, MD.
- Dorsch, J.A., and Dorsch, S.E. (1984). “Understanding Anesthesia Equipment,” 2nd ed., pp 136–181. Williams & Wilkins, Baltimore, MD.
- Dorsh, J.A., and Dorsch, S.E. (1999). Monitoring devices. In “Understanding Anesthesia Equipment,” 4th ed., pp 679–919. Williams & Wilkins, Baltimore, MD.
- Dyson, D.H., Allen, D.G., and McDonnell, W.N. (1985). Evaluation of three methods for cardiac output determination in cats. *Am. J. Vet. Res.* **46**, 2546–2552.
- Geddes, L.A. (1984). “Cardiovascular Devices and Their Application,” pp 63–99. Wiley, New York.
- Greene, S.A., Benson, J.G., Tranquilli, W.J., and Grimm, K.A. (2004). Effect of isoflurane, atracurium, fentanyl, and noxious stimulation on bispectral index in pigs. *Comp. Med.* **54**(4), 397–403.
- Gyermek, L., Lee, C., Cho, Y.M., and Nguyen, N. (2006). Quaternary derivatives of granatanol diesters: Potent, ultrashort acting non-depolarizing neuromuscular relaxants. *Life Sci.* **79**, 559–569.
- Haga, H.A., and Dolvik, N.I. (2002). Evaluation of the bispectral index as an indicator of degree of central nervous system depression in isoflurane-anesthetized horses. *Am. J. Vet. Res.* **63**, 438–442.
- Hagaman, J.R., John, S., Xu, L., Smithies, O., and Maeda, N. (2005). An improved technique for tail-cuff blood pressure measurements with dark-tailed mice. *Contemp. Top.* **44**(5), 43–46.
- Hall, L.W., and Clarke, K.W. (1991). “Veterinary Anesthesia,” pp 113–135. Bailliere Tindall, London.
- Hartsfield, S.M. (1992). Anesthesia and control of pain responses during surgery of the eye. In “Animal Pain” (C.E. Short and A. Van Poznak, eds.), pp 338–347. Churchill-Livingstone, New York.
- Haskins, S.C. (1987). Monitoring the anesthetized patient. In “Principles and Practice of Veterinary Anesthesia” (C.E. Short, ed.), pp 455–477. Williams & Wilkins, Baltimore, MD.
- Haskins, S.C. (1996). Monitoring the anesthetized patient. In “Lumb & Jones’ Veterinary Anesthesia” (J.C. Thurmon, W.J. Tranquilli, and G.J. Benson, eds.), 3rd ed., pp 409–424. Williams & Wilkins, Baltimore, MD.
- Krege, J.H., Hodgins, J.B., Hagaman, J.R., and Smithies, O. (2005). A noninvasive computerized tail-cuff system for measuring blood pressure in mice. *Hypertension* **25**(5), 1111–1115.
- Lamont, L.A., Greene, S.A., Grimm, K.A., and Tranquilli, W.J. (2004). Relationship of bispectral index to minimum alveolar concentration multiples of sevoflurane in cats. *Am. J. Vet. Res.* **65**, 93–98.
- Lumb, W.V., and Jones, E.W. (1996). Monitoring of the anesthetized patient. In “Veterinary Anesthesia,” 3rd ed., pp 409–424.
- March, P.A., and Muir, W.W. (2003). Use of bispectral index as a monitor of anesthetic depth in cats anesthetized with isoflurane. *Am. J. Vet. Res.* **64**, 1534–1541.
- March, P.A., and Muir, W.W. (2005). Bispectral analysis of the electroencephalogram: A review of its development and use in anesthesia. *Vet. Anaesth. Analg.* **32**, 241–255.
- McKelvey, D., and Hollingshead, K.W. (2003). General anesthesia. In “Veterinary Anesthesia and Analgesia,” 3rd ed., pp 51–118. Mosby Elsevier Science, St. Louis, MO.
- Moens, Y., and Versraeten, W. (1982). Capnographic monitoring in small animal anesthesia. *J. Am. Anim. Hosp. Assoc.* **18**, 659–678.
- Myles, P.S., Leslie, K., McNeil, J., Forbes, A., and Chan, M.T. (2004). Bispectral index monitoring to prevent awareness during anaesthesia: The B-aware randomized controlled trial. *Lancet* **363**, 1757–1763.
- NRC (National Research Council). (2003). Guidelines for the care and use of mammals in neuroscience and behavioral research. A report of the Institute of Laboratory Animal Resources Committee on Guidelines for the Care and Use of Animals in Neuroscience and Behavioral Research. National Academies Press, Washington, D.C.
- Nunn, J.F. (1987). “Applied Respiratory Physiology,” 3rd ed., pp 350–378. Butterworth, London.
- Public Health Service (PHS). (2000). “Public Health Service Policy on Humane Care and Use of Laboratory Animals.” Office of Laboratory Animal Welfare, Washington, D.C.
- Rember, M.S., Smith, J.A., and Hosgood, G. (2004). A comparison of forced-air warming system to traditional thermal support for rodent microenvironments. *Lab. Anim.* **38**(1), 55–63.
- Sarton, E., Dahan, A., Teppema, L., Berkenbosch, A., van den Elsen, M., and van Kleef, J. (1997). Influence of acute pain induced by activation of cutaneous nociceptors on ventilatory control. *Anesthesiology* **87**, 289–296.
- Schneider, G., Gelb, A.W., Schmeller, B., Tschakert, R., and Kochs, E. (2003). Detection of awareness in surgical patients with EEG-based indices—bispectral index and patient state index. *Br. J. Anaesth.* **91**, 329–335.
- Severinghaus, J.W., and Kelleher, J.F. (1992). Recent developments in pulse Oximetry. *Anesthesiology* **76**, 1018–1038.
- Shapiro, B.A., Harrison, R.A., and Walton, J.R. (1982). “Clinical Application of Blood Gases,” 3rd ed., pp 131–142. Year Book Medical Publishers, Chicago, IL.
- Sigl, J.C., and Chamoun, N.G. (1994). An introduction to bispectral analysis for the electroencephalogram. *J. Clin. Monit.* **10**, 392–404.
- Sparr, H.J., Beaufort, T.M., and Fuchs-Buder, T. (2001). Newer neuromuscular blocking agents: How do they compare with established agents? *Drugs* **61**, 919–942.
- Steffey, E.P. (1984). Inhalation anaesthesia. In “Anesthesia of the Cat” (L.W. Hall and P.M. Taylor, eds.), pp 157–193. Bailliere Tindall, London.
- Struys, M., Versichelen, L., Byttebeir, G., Mortier, E., Moerman, A., and Rolly G. (1998). Clinical usefulness of the bispectral index for titrating propofol target effect-site concentration. *Anaesthesia* **53**, 4–12.
- Taylor, P. (1996). Agents acting at the neuromuscular junction and autonomic ganglia. In “Goodman & Gilman’s The Pharmacological Basis of Therapeutics” (J.G. Hardman, L.E. Limbird, P.B. Molinoff, R.W. Ruddon, and A.G. Gilman, eds.), 9th ed., pp 177–197. McGraw-Hill, New York.
- Tilley, L.P. (1992). “Essentials of Canine and Feline Electrocardiography,” 3rd ed. Lea & Febiger, Philadelphia.

Waste Anesthetic Gas Safety

Jennifer C. Smith

I. Introduction	183
II. Potential Health Effects	185
A. Historical Perspectives	185
B. Adverse Health Effects	186
III. Sources of Waste Anesthetic Gas	187
A. Anesthetic Machine	187
B. Anesthetic Environment	187
C. Patient	187
IV. Evacuation of WAG	188
A. Active Scavenging Equipment and Techniques	188
B. Passive Scavenging Equipment and Techniques	188
C. Environmental Effects of Evacuation	189
V. Risk Assessment and Mitigation	189
A. Sampling Methodology	189
B. Risk Mitigation	190
VI. Summary and Conclusions	192
References	192

I. INTRODUCTION

Over the past 40 years, the level of awareness of waste anesthetic gas (WAG) pollution has steadily increased. It is now an accepted belief that the use of volatile anesthetics will release WAG into the environment. In fact, it is estimated that some 200,000 healthcare professionals—including 50,000 veterinarians and veterinary technicians—are routinely exposed to trace levels of WAGs (OSHA, 2000).

The degree of interest in WAG pertaining to the veterinary environment, in particular the laboratory animal setting, has

also increased. The first published works addressing WAG pollution in the veterinary setting occurred in 1976 (Sawyer, 1976a, 1976b), 1977 (Best and McGrath, 1977), and 1980 (Manley and McDonnell, 1980a, 1980b). Although these early commentaries created awareness of the subject, actual research studies were not conducted for several years. The first of these studies (Ruby et al., 1980; Wingfield et al., 1980) surveyed veterinarians participating in small-animal private practice in the state of Colorado. The results indicated that although there was exposure to WAG in private veterinary practice hospitals, it was far less than what was being reported in the human literature. A similar

study was conducted in the following year (Dreesen et al., 1981) to assess the risk of WAG exposure to students, staff, and faculty in a veterinary teaching hospital (University of Georgia). This study concluded that WAG exposure was present, but credited the newly established scavenging system for keeping the exposure to a minimum. Ward and Byland (1982a, 1982b) reported on the use of a spectrophotometer device to monitor the real-time exposure to WAG of veterinary personnel. This technique of air sampling remains the gold standard for monitoring today. Also in 1982 (Milligan and Saban), real-time monitoring results were reported specifically for the recovery room at a veterinary teaching hospital (Cornell University). This study showed that postextubation emission of methoxyflurane was dependent on the anesthetic concentration delivered and that WAG could be emitted for up to 128 minutes. In 1987, the first retrospective study was published to assess reproductive outcome with occupational exposure in veterinarians (Johnson et al., 1987). One thousand nine hundred fourteen women who graduated from U.S. veterinary schools from 1970 to 1980 were surveyed. Although no direct correlations could be drawn from this study, it was concluded that advice and training should be included upon employment. These early environmental measurements made in veterinary facilities indicated that these exposures are an order of magnitude or more below the levels measured in human surgical facilities (Johnson et al., 1987). However, the risk from low-level WAG exposure in the laboratory animal environment was unknown. In 2002, the first study conducted in the laboratory animal environment demonstrated that WAG pollution should also be expected when common rodent surgical techniques are employed (Smith and Bolon, 2002). The reader is directed to Table 7-1 for a brief review of the key contributions to the veterinary literature as described above.

Any discussion of WAG pollution would be incomplete without including information on the U.S. government safety guidelines. The passage of the Occupational Safety and Health

Act (1970) created two separate regulating bodies with different responsibilities to carry out the provisions of the Act. The National Institute for Occupational Safety and Health (NIOSH) was created to oversee research, education, and rule making, as they relate to occupational illnesses; the Occupational Safety and Health Administration (OSHA) was created to provide investigative, enforcement, and standard enacting responsibilities of the Act (Dorsch and Dorsch, 1999). To assist NIOSH in formulating its current Criteria for a Recommended Standard document (NIOSH, 1977), the American Society of Anesthesiologists (ASA) joined forces with NIOSH. An ASA ad hoc committee was formed in 1974 with the charter of conducting a large U.S. epidemiological study of operating room personnel. The first report from this committee was published in 1974, with the expectation that a follow-up study would be done in 1978 to measure the effectiveness of the adoption of WAG-scavenging techniques. However, after the alleged incriminating data from the first study (1974), NIOSH withdrew its support of the follow-up study and went on to finalize its criteria document. Of note is the fact that this NIOSH Criteria Document (1977) has never been adopted as a federal standard and thus is not officially enforceable by OSHA. However, in the absence of any further U.S. policy document on this issue, these recommendations are still referred to today. A summary of the NIOSH Criteria Document, including its notorious Recommended Exposure Levels (RELs) for halogenated agents, has been prepared for readers in Table 7-2. After the NIOSH Criteria Document was released, the ASA published "Waste Anesthetic Gases in Operating Room Air: A Suggested Program to Reduce Personnel Exposure," written by its Ad Hoc Committee on Effects of Trace Anesthetic Agents on Health of Operating Room Personnel (1981). This document has subsequently been revised to include more current standards and information (ASA, 1999). And in 1989,

TABLE 7-1

KEY CONTRIBUTIONS TO WAG POLLUTION IN VETERINARY LITERATURE

Year	Author(s)	Contribution summary
1976	Sawyer	Earliest mention of occupational WAG exposure hazards in veterinary industry
1980	Manley and McDonnell	Recommended the employment of gas-scavenging system for a reduction in WAG pollution
1980	Ruby et al.	First retrospective study—private practice
1981	Dreesen et al.	First retrospective study—veterinary school
1982	Ward and Byland	Utilized infrared spectrophotometer equipment for real-time assessment
1982	Milligan and Saban	Monitored anesthetic pollution in recovery rooms
1987	Johnson et al.	First retrospective study on reproductive outcomes
1990	Burkhart and Strobe	Described mobile charcoal adsorption device
2002	Smith and Bolon	Reported WAG emissions in rodent laboratory animal setting

TABLE 7-2

SUMMARY STATEMENTS OF CURRENT NIOSH RECOMMENDATIONS (NIOSH, 1977) AS THEY RELATE TO THE LABORATORY ANIMAL SETTING

Issued RELs for both N ₂ O and halogenated agents (including methoxyflurane, halothane, and enflurane)
No worker should be exposed at ceiling concentrations greater than 2 ppm of any halogenated anesthetic agent over a sampling period not to exceed 1 hour
The REL of N ₂ O, when used as the sole inhaled anesthetic agent, is 25 ppm measured as a TWA
All anesthetic delivery machines should be equipped with WAG collection (<i>scavenging</i>) and removal (<i>disposal</i>) devices from the work environment
Anesthetic <i>work practices</i> should be utilized to obtain and maintain minimum WAG concentrations
<i>Medical surveillance</i> shall be made available to all employees subject to occupational exposure of WAG
Employees shall be <i>informed</i> of the possible health effects of exposure to WAG
An <i>air-monitoring program</i> shall be implemented and supervised by knowledgeable personnel, with appropriate <i>record keeping</i> to follow

TABLE 7-3
SUMMARY OF U.S. RECOMMENDATIONS PERTAINING TO WAG SAFETY

Year	Action	Summary of action
1970	Passage of Occupational Health and Safety Act ^a	NIOSH ^b and OSHA ^c agencies established
1974	ASA ^d Ad Hoc Committee epidemiological study	Conducted national study of effects of WAG on health of operating room personnel
1977	Criteria document prepared by NIOSH ^e	Recommended permissible levels of exposure (REL) for halogenated anesthetic agents ^f
1981	ASA publication	ASA Ad Hoc Committee results ^g
1983	Joint Commission on Accreditation of Healthcare Organizations	Recommend that all anesthesia machines be equipped with gas-scavenging devices
1987	ACGIH ^h	TLV-TWA recommendations ⁱ
1994	NIOSH Alert ^j	Updates on N ₂ O usage and safety
1996	AVCA Ad Hoc Committee	Veterinary anesthesia specialty recommendations ^k
1999	ASA document revision	Revised 1981 publication ^l
2000	OSHA Guidelines ^m	Established guidelines for use of halogenated agents in the workplace

^aOccupational Safety and Health Act of 1970, PL 91-596.

^bNational Institute for Occupational Safety and Health.

^cOccupational Safety and Health Administration.

^dAmerican Society of Anesthesiologists Ad Hoc Committee on Effects of Trace Anesthetic Agents on the Health of Operating Room Personnel.

^eNIOSH Criteria for a Recommended Standard: Occupational Exposure to Waste Anesthetic Gases and Vapors, Publication No. 77-140 (1977).

^fSummarized in Table 7-3.

^gASA Ad Hoc Committee on Effects of Trace Anesthetic Agents on the Health of Operating Room Personnel. Waste Anesthetic in Operating Room Air: A Suggested Program to Reduce Personnel Exposure (1981).

^hAmerican Conference of Governmental Industrial Hygienists.

ⁱAmerican Conference of Governmental Industrial Hygienists. Threshold limit value-time-weighted average (TLV-TWA) of 50 ppm for N₂O.

^jNIOSH Alert: Controlling Exposures to Nitrous oxide During Anesthetic Administration, DHHS (NIOSH), Publication No. 94-100 (1994).

^kAmerican College of Veterinary Anesthesiologists (ACVA), Ad Hoc Committee on Waste Anesthetic Gas Pollution and its Control. Commentary and recommendations on control of waste anesthetic gases in the workplace (1996).

^lASA revised document, Information for Management in Anesthetizing Areas and the Postanesthesia Care Unit (PACU) (1999).

^mOccupational Safety and Health Association (OSHA). Guidelines for workplace exposures (2000).

the American Conference of Governmental Industrial Hygienists (ACGIH) assigned a threshold limit value-time-weighted average (TLV-TWA) for nitrous oxide (N₂O), halothane, and enflurane of 50, 50, and 75 ppm (parts per million), respectively (for a normal 8-hour workday).

Table 7-3 provides a brief review of the historical events in U.S. WAG recommendations that are in place today.

II. POTENTIAL HEALTH EFFECTS

A. Historical Perspectives

WAG contamination of the work environment is not a new phenomenon. Its discussion in medical literature dates back to the early 1900s when a German surgeon made the connection between deleterious health effects to surgeons and constant exposure to anesthetics (Kelling, 1918). In the 1920s, the idea of removing these hazardous anesthetic gases from the operating environment was discussed (Goerig and Pothmann, 2004). Early mentions of WAG pollution and health concerns in the literature were strictly anecdotal until the 1960s, when A.I. Vaisman, a Russian anesthesiologist, published a now-historical epidemiological report correlating work conditions with the

adverse health effects experienced by Russian anesthesiologists (Vaisman, 1967). Of particular concern in this notable study was the suspected link between WAG and the reported increase in spontaneous abortions. Sixteen similar studies were embarked upon during the next decade; most have now been criticized for their poor study design, statistical errors, underpowering, and poor result analysis. Nine of these studies connected occupational exposure to WAGs with deleterious health effects, and the remaining seven failed to make a statistically significant correlation (Sessler, 1998). One of these studies was a large epidemiological study undertaken jointly by the ASA and NIOSH (ASA, 1974). This study reported an increased risk of spontaneous abortions in exposed women and an increased risk of congenital abnormalities in the offspring of exposed males; a 1.3- to 2-fold increase in the occurrence of cancer (leukemia and lymphoma) in exposed females; a significant increase in hepatic disease in all exposed women and some exposed men; and a 1.2- to 1.4-fold increase in renal disease in exposed women (Foley, 1993).

WAG studies after 1980 attempted to substantiate the data of the earlier anecdotal studies. Laboratory investigations were conducted utilizing live animals, tissues, and cell cultures in an attempt to provide sound scientific evidence to support the early epidemiological data. The distinctions between trace and high levels of WAG were also established after 1980, when the

successful adoption of scavenging techniques occurred. Dorsch and Dorsch (1999) define a trace level of anesthetic gas as being far below the concentration needed for anesthesia, or that can be detected by smell. To date, there have been no successful studies performed that link occupational exposure to trace levels of WAG with any adverse health effects. The ASA Task Force (1999) notes that even though adverse health effects are associated with chronic exposure to high levels of WAG, studies have failed to demonstrate an association between trace levels of WAG (such as found in scavenged human/veterinary hospitals) and adverse health effects. The Task Force concluded that even at the maximum allowable dose of isoflurane and halothane, there was no evidence of significant health damage and therefore no data to suggest that WAG exposure is dangerous to hospital employees (including pregnant women) working in a properly scavenged environment (ASA, 1999).

In summary, controversy still remains concerning the actual adverse health effects (discussed below) linked to occupational exposure to WAG, as well as how much effort should be placed on risk mitigation. As discussed in Section I, initial veterinary literature concluded that the exposure levels of veterinarians and staff exposed to WAG were lower than exposures reported for personnel in human hospitals. Subsequent veterinary studies have shown that this early premise may be incorrect (McKelvey and Hollingshead, 2003). However, these veterinary studies were not undertaken in a laboratory animal environment where common work practices (use of induction box, high carrier-gas flow rates, use of face masks, multiple patient delivery systems, high-throughput design, etc.) increase the likelihood of occupational WAG exposure (Smith and Bolon, 2002). Therefore, in the laboratory animal environment, it is reasonable to conclude that continued vigilance to the reduction of occupational exposure to WAG remains a high priority.

B. Adverse Health Effects

1. Short Term vs. Long Term

The majority of studies reporting potential adverse health effects of WAG exposure relate to chronic or long-term exposure (weeks, months, and/or years of exposure). In the short-term setting (immediately after the exposure), effects including drowsiness, irritability, depression, headache, nausea, and fatigue have been reported (NIOSH, 1977). Perceptual, cognitive, and motor skill deficits have been reported in anesthesiologists after high levels of WAG exposure in unscavenged environments (Burm, 2003). Although these effects usually dissipate soon after WAG exposure, they are of particular concern as the success of the surgery and health of the operating room staff may be compromised during exposure. However, these short-term neurological effects are not expected to occur when proper work practices (i.e., scavenging of WAGs) are in place (Dorsch and Dorsch, 1999).

2. Reproduction

The most widely discussed area of WAG exposure is in the field of reproduction where there is some evidence that high concentrations of WAG exposure could adversely affect the reproductive system and the developing fetus (McKelvey and Hollingshead, 2003). The early studies built the foundation of presumptive evidence that occupational exposure to WAG is linked to a higher incidence of spontaneous abortions, congenital abnormalities, and infertility. Most of these early studies on reproduction have since been extensively reviewed. Buring et al. (1985) conducted a meta-analysis on behalf of the ASA Ad Hoc Committee and calculated a relative risk for spontaneous abortion among exposed females at 1.3 (95% confidence limits from 1.2 to 1.4) for epidemiological studies conducted between 1970 and 1982. The most recent meta-analysis of an epidemiological study, conducted in 1997, calculated a relative risk of 1.48 for spontaneous abortion in women (Boivin, 1997). The statistical data related to congenital abnormalities was also analyzed, and similarly found to be nonconclusive. In summary, the interpretation of many of these reproductive studies is complicated by the inconsistent use of anesthetic agent, variable exposure time and anesthetic concentration, and the use/disuse of proper scavenging systems. Thus, it is now commonly believed that while exposure to abnormally high concentrations of WAG could cause reproductive abnormalities, there is a little risk when the exposure concentrations are kept at trace levels.

3. Hepatotoxicity

The literature is replete with information linking volatile anesthetics (particularly halothane) with liver damage, although the mechanism is yet uncertain. One study (McKelvey and Hollingshead, 2003) reported that the risk of liver disease in human-anesthesia healthcare workers was 1.5 times greater than among the general population. A rare condition, halothane hepatitis, has been described in which anesthetized individuals form antigenic metabolites of halothane that cause a delayed autoimmune response to hepatocytes (Byhahn et al., 2001). Although similar research data for the newer halogenated agents (isoflurane, enflurane, sevoflurane, and desflurane) exist, there has yet to be conclusive proof that long-term exposure to these agents causes any hepatocellular injury (Dorsch and Dorsch, 1999).

4. Carcinogenicity

The premise that WAGs may exert adverse effects on DNA has suggested their potential to cause other DNA-related changes such as cancer. Early studies suggested that WAG exposure was related to various types of cancer. However, as is the case with most of these early concerns, these studies have since been dismissed based on poor data collection and statistical analysis. It is now generally thought that, used properly, current anesthetic

agents are not carcinogenic at the levels found in the modern operating environment (McKelvey and Hollingshead, 2003). Studies of the effects of volatile anesthetics on the formation of sister chromatid exchanges as an assessment of genetic damage provide an alternative to carcinogenicity studies, but are not reliably predictive (Hoerauf et al., 1999). Nevertheless, these recent studies have failed to show a correlation between trace levels of occupational exposure to WAG and cancer (Dorsch and Dorsch, 1999).

5. Others

Various reports have been published incriminating WAG exposure in cardiac, kidney, and hematologic diseases. Renal toxicity in anesthetized patients has been associated with the use of methoxyflurane, due to its toxic metabolites of inorganic fluoride and oxalic acid (Smith, 1993). However, the association between renal disease and occupational exposure to trace levels of WAGs has not been made. Several studies (predominantly in dental practice) have implicated N₂O as a cause of hematologic disease. The suggested mechanism involves the physicochemical reaction between N₂O and vitamin B₁₂ after inhalation, which leads to megaloblastic changes in the bone marrow. These changes were reported after exposure to high concentrations of N₂O that are generally not present in routine laboratory animal practice today (Dorsch and Dorsch, 1999).

III. SOURCES OF WASTE ANESTHETIC GAS

A. Anesthetic Machine

The anesthetic machine is the essential tool of the anesthetist, as it serves as the primary workstation; this equipment is also the greatest source of WAG in the environment. This is an area where the differences between some veterinary and human anesthesia practices are notable. The work practices pertaining to the former (e.g., rodents) are generally focused around a patient that may be several orders of body size smaller than the latter (humans). To accommodate this fundamental difference, work practices including the use of induction boxes, face masks, and higher carrier-gas flow rates are followed. Methods of WAG collection and capture have been incorporated into the induction process in an attempt to improve WAG scavenging. However, unless the induction box is properly purged of anesthetic gas to decrease the WAG concentration, its opening will cause significant pollution in the unscavenged work environment.

Another source of leakage is the anesthetic machine and associated delivery equipment. This source of WAG pollution is especially problematic because it is often not recognized and cannot be reduced by the anesthetic machine's scavenging system. Leakage can occur anywhere in the system, but common

sources are connections between tubing and devices, around face masks and seals that are not tight fitting, and at the scavenging device. A facemask is commonly used during laboratory animal anesthesia, especially when intubation of the patient is difficult or not possible. Although progress has been made in improving the design and overall tightness of the seal of the face mask to the animal, leakage does result. A recent study demonstrated that the use of traditional rodent face masks will result in significant levels of WAG and exposure of laboratory personnel to levels above the NIOSH recommendations (Smith and Bolon, 2005).

B. Anesthetic Environment

Pollution of the surrounding environment also exists while volatile anesthetic agents are being used. Examples of this type of pollution occur when the vaporizer is being filled or emptied, the liquid anesthetic is accidentally spilled, or there is room drift. The latter occurs when volatile agents are used repeatedly over a long period—a common scenario in laboratory animal medicine—and the overall background concentration in the surrounding environment steadily increases as a factor of both time and amount of anesthetic gas vapor used (Smith and Bolon, 2002, 2003).

C. Patient

One frequently overlooked source of WAG is the patient. Although there have been numerous studies describing WAG pollution, very few are specific to exposure after the patient leaves the surgical area. Exposure of recovery room and PACU (postanesthesia care unit) personnel to WAG via the exhaled breath of postoperated human and veterinary patients has been reported. Corbett and Ball (1971) showed that methoxyflurane in the end-expired air of patients and anesthesiologists was detectable for 10–18 days and 30 hours after an anesthetic event, respectively. Bruce and Linde (1972), Byhahn et al. (1998), and Sessler and Badgwell (1998) measured human PACU halothane concentrations and found them to exceed the current NIOSH recommendations; and Corbett and Ball (1971) reported increased concentrations of fluoride in the urine of anesthesiologists. In the veterinary literature, Milligan and Saban (1982) reported that methoxyflurane was emitted for up to 128 minutes postextubation in the canine, while Smith and Bolon (2003) reported that isoflurane was emitted 18 hours postcanine extubation. These studies confirm that occupational exposure to WAG, at levels exceeding trace amounts, occurs in many areas of both human and veterinary hospitals, and identify the patient as contributing to this exposure. In the veterinary and laboratory animal settings, this exposure can be extended to the research staff or animal owner. Therefore, the planning

and construction of recovery room areas should consider proper room ventilation as well as exhaust methods for WAG.

IV. EVACUATION OF WAG

Scavenging or evacuation of WAG is the process of collecting the excess gases from the anesthetic delivery equipment, or the patient, and removing them from the working environment. Scavenging or evacuation systems utilize gas-capturing devices, interfaces, and gas-disposal systems to accomplish this important task. A comprehensive discussion of anesthetic-machine scavenging equipment (specifically gas-capturing and interface devices that are described in Chapter 5 of this book) is outside of the scope of this chapter.

The NIOSH Criteria Document (NIOSH, 1977) recommends scavenging of WAGs, work practices to reduce WAG pollution, monitoring of WAG, and medical surveillance of all potentially exposed personnel. Of these recommendations, the most effective step in reducing the levels of WAG in the surgical environment is the installation of an effective scavenging system (McGregor, 2000). The *Guide for the Care and Use of Laboratory Animals* by NRC (NRC, 1996) states: “Exposure to anesthetic waste gases should be limited. This is usually accomplished by using various scavenging techniques.”

In general, the concentration of N₂O and halothane reported to occur in the anesthetist’s breathing zone in a ventilated surgical suite (without scavenging) during the 1970s was 200–500 and 2–5 ppm, respectively. N₂O and halothane concentrations in unventilated, unscavenged surgical suites were as high as 7,000 and 85 ppm, respectively (McKelvey and Hollingshead, 2003). The NIOSH Criteria Document (NIOSH, 1977) recommended the use of a scavenging system in human hospitals, which is capable of reducing halothane and N₂O concentrations to 0.2–0.5 and 15–35 ppm, respectively. In veterinary hospitals, the adoption of scavenging techniques reduced isoflurane and halothane concentrations to 1–20 ppm and the N₂O concentrations to 50–200 ppm (Gardner, 1991). It has been demonstrated that the use of scavenging techniques will reduce the concentrations of WAG tenfold (Lecky, 1977), or by 90% (ACVA, 1996). However, even with the successful addition of WAG-scavenging systems, the need for implementation of training and equipment-checking procedures is necessary. A study by Soontranan et al. (2002) showed that 10/38 scavenging systems (26.3%) within a third-world (Thailand) human teaching hospital were incorrectly installed. All problems were due to errors in the assembly of the devices and could have been avoided with routine preuse equipment checks and regular maintenance.

A. Active Scavenging Equipment and Techniques

Active scavenging occurs when a pump or fan is used to move anesthetic gases away from the patient and equipment,



Fig. 7-1 Example of simple “snorkel apparatus” for active WAG evacuation placed at the induction-box opening.

and into the scavenging device. This is the most effective way to remove WAG. Many types of active scavenging systems are available in both human and veterinary settings (McKelvey and Hollingshead, 2003).

A form of active scavenging used in the laboratory animal environment is the “snorkel apparatus” (Fig. 7-1). This consists of corrugated plastic or stainless-steel tubing that is directly vented to the heating, ventilation, and air-conditioning (HVAC) system (nonrecirculating air). The amount of suction necessary for evacuation will vary depending on the diameter of tubing, the type of anesthetic carrier-gas flow rates, and the existing facility design. These devices are generally placed around the inhalant anesthetic delivery equipment at areas where WAG emissions are the highest (vaporizer-filling port, induction box, animal: face-mask interface, charcoal adsorption canister vents, etc). Advantages of these snorkel devices include ease of use and flexibility in placement. Disadvantages include the initial expense of ducting these devices within the existing facility design, and increased difficulty in cleaning and maintaining a sterile surgical environment.

B. Passive Scavenging Equipment and Techniques

A passive system of scavenging WAG utilizes the positive pressure of the gas in the anesthetic machine to push the WAG into the scavenging device. Different types of passive configurations can be used, which in the laboratory animal environment commonly include discharge tubing, room ventilation, and activated charcoal adsorption canisters.

Discharge tubing simply connects the anesthetic machine with the outside environment, usually through a hole in a wall. McKelvey and Hollingshead (2003) recommend that the distance to the outside environment should be less than 20 feet, making this method suitable only for externally adjacent rooms.

The use of the room's nonrecirculating ventilation system is also an example of passive scavenging. In this situation, the standard air changes per hour of the room's ventilation are employed to remove WAG and reduce their levels to acceptable standards. The ACVA (1996) recommends that a nonrecirculating ventilation system, which can provide at least 12–15 air changes per hour, should be used for this purpose.

In situations where other scavenging systems are not available, activated charcoal filters can be used to absorb volatile anesthetic agents from the waste gas. However, these devices cannot be used to remove N₂O. In the veterinary/laboratory animal setting, the use of these canisters is common due to their low cost, ease of use, and portability. Studies to qualify and quantify the effectiveness of these canisters in the laboratory animal setting (Smith and Bolon, 2002, 2003) found that breakthrough emissions of WAG should be expected when these devices are used. Furthermore, their use resulted in WAG concentrations above the NIOSH RELs, illustrating the need for vigilant monitoring and removal of such containers when they have reached their manufacturer's suggested end of life or when breakthrough emission of WAG occurs.

Active and passive scavenging techniques may be used alone or in combination. The latter option provides the most effective WAG scavenging and is recommended by the ACVA (1996) for the veterinary and laboratory animal settings.

C. Environmental Effects of Evacuation

Once proper evacuation of WAG has occurred, it is usually not thought of again. However, the effect of halogenated agent pollution in the outside environment deserves discussion. The volatile anesthetics (halothane, enflurane, and isoflurane) are classified as halogenated chlorofluorocarbons or H-CFCs; and release fluorine, chlorine, and bromine into the atmosphere where they damage the ozone layer. The newer volatile anesthetics, sevoflurane and desflurane, are not H-CFCs but rather fluorinated hydrocarbons (FHCs), which contain only fluorine and thus are considered less damaging to the ozone layer (Marx, 1999). One recent study calculated that 25 million liters of volatile anesthetics are released from German hospitals annually (Marx et al., 2001). To date, it has been considered acceptable practice to vent or exhaust these agents directly to the outside air. However, the Montreal Protocol on Substances That Deplete the Ozone Layer has proposed the abolition of H-CFC release into the atmosphere by the year 2030 (UN, 1987). The effect this will have on volatile anesthetic use in the future remains to be seen.

V. RISK ASSESSMENT AND MITIGATION

A. Sampling Methodology

Techniques other than air sampling have been utilized for the assessment of WAG exposure. These techniques involve measuring the products of anesthetic gas metabolism in the blood or urine. Imberti et al. (1995) described the technique of urine collection and mathematical calculation of the urine/air partition coefficient for use in WAG assessment. Hoerauf et al. (1997) compared the calculated urine/air partition coefficient with values collected by real-time monitoring, and found them to be comparable. Biological monitoring can be used as an adjunct to other monitoring modalities in a comprehensive WAG emission control program; however, the fundamental tool used to evaluate workplace exposure to WAG remains air sampling.

1. Instantaneous Air Sampling

This method is often referred to as grab or snatch sampling because of its collection process. A sample of air from the anesthetic environment is quickly collected into a container (plastic or nylon bag) and transferred to a processing laboratory. This method is quick, simple to perform, and also inexpensive. The disadvantage of this method is the time interval between sample collections and result reporting, which means this method is not suitable for real-time assessment (Dorsch and Dorsch, 1999).

2. Time-weighted Average Sampling

Time-weighted average (TWA) sampling encompasses both amount of time and concentration of WAG exposure. Thus, the TWA exposure refers to the average airborne concentration of a substance during a normal 8–10 hour workday. NIOSH recommends that the maximum TWA concentration of volatile halogenated anesthetics should not exceed 2 ppm over a period of no greater than 1 hour (NIOSH, 1977). NIOSH also recommends that no worker should be exposed to ceiling concentrations greater than 2 ppm of any halogenated anesthetic agent over a sampling period not to exceed 1 hour. These recommendations for volatile anesthetics include short-term exposure limits or ceiling values that are intended to supplement the TWA where there are recognized toxic effects from the high short-term exposures (NIOSH, 1977). TWA sampling can be used as an assessment tool alone, but is much more effective when used in combination with real-time monitoring results.

Active and passive dosimetry monitoring are the usual methods of obtaining TWA samples. Passive dosimetry devices are commonly used in the laboratory animal environment due to their ease of use, minimal maintenance and expense, and ability to provide data for written reports. These devices, also called dosimeters, function by diffusion of the gas through the molecular filter inside. Once the proper amount of time has elapsed,

the badge is transferred to the analysis laboratory where a TWA report is generated. Disadvantages of these devices include inability to obtain real-time information, and greater potential for operator error if the badge is not worn properly or is damaged during the workday (Dorsch and Dorsch, 1999).

3. Continuous Air Sampling

Up until 1980, the most commonly reported way to monitor air samples was discontinuous gas chromatography (Bruce and Linde, 1972). Since 1980, the use of infrared spectrophotometry has replaced gas chromatography and become the gold standard for collecting air samples. This change reflects the ability of infrared spectrophotometry to provide continuous, or real-time, sampling and therefore immediate feedback of results. This advantage makes immediate work practice modifications, including identification of brief peak exposure levels and correction of system leaks, possible. The main disadvantage of this method is the purchase/rental of the equipment—infrared spectrophotometer or ambient air analyzer—necessary to perform the sampling (Dorsch and Dorsch, 1999). An example of an infrared spectrophotometer currently used in WAG monitoring is shown in Fig. 7-2.

B. Risk Mitigation

1. Monitoring Surveillance Plan

The best way to assess the success of an occupational safety and health program, in regard to WAG management, is to adhere to a well-thought-out plan of air monitoring. Such a plan is necessary even with the assurance that best work practices are being followed, including scavenging and disposal of WAG (Dorsch and Dorsch, 1999).



Fig. 7-2 Infrared spectrophotometer (Series 205A, Miran SapphiRe, Foxboro Co., Foxboro, MA) for determination of real-time WAG monitoring.

a. Direction

According to Dorsch and Dorsch (1999), direction of the monitoring surveillance program should be undertaken by someone who is both interested and qualified, preferably from the anesthesia department. In the laboratory animal setting, this is not usually the case, and often such a monitoring program is directed by the occupational safety and health department, or by an outside consultant NRC (1987).

b. Sites to be Monitored

NIOSH (1977) recommends that air sampling be conducted in areas that are representative of the concentrations at which workers are exposed during routine procedures. A comprehensive program for the laboratory animal research setting should include all rooms where volatile anesthetics are being used.

c. Frequency of Monitoring

OSHA (2000) recommends that air sampling should be performed every 6 months. In addition, it is recommended that only the most frequently used halogenated agent should be monitored, as proper WAG controls and work practices should reduce all agents proportionally (OSHA, 2000).

d. Record Keeping

The ASA (1999) recommends that the permanent medical record of employees be kept for the duration of employment plus 20 years. NIOSH (1977) and the ASA (1999) recommend that all complete air-sampling records should be maintained for a period of at least 20 years.

e. Medical Surveillance

Medical surveillance shall be made available to all employees subjected to WAG occupational exposure. In addition, NIOSH (1977) recommends that preplacement medical and occupational histories and examinations be conducted on all employees subject to exposure to WAG. These histories and physicals should be conducted annually thereafter, and all results should be kept in the employees' permanent medical records. In addition, any abnormal pregnancy outcome in an employee, or spouse of an employee, should be documented in the employee's permanent medical record, which is maintained for the period of employment plus 20 years (ASA, 1999). OSHA (2000) also recommends that the following techniques should be added to the medical surveillance program: a system for all employees to report health concerns that they believe *may* be associated with WAG exposure; the adoption of a reproductive hazards policy to be posted within the facility; documentation and review of a sudden high exposure; and a final medical review upon job termination or transfer. In the laboratory environment, the extent of medical surveillance is not usually this comprehensive

and will depend on individual facility programs to implement and maintain.

f. Education of Personnel

Both NIOSH (1977) and OSHA (2000) recommend education of all personnel who could be exposed to WAG. This program should include an overview of the topic, information on maintenance and checking of equipment, and work practices that would help to reduce anesthetic pollution. Such training should also include information on potential adverse health effects and how WAG exposure can be avoided. In the research setting, this educational step is usually the responsibility of the environmental health safety group associated with the animal facility. The *Guide for the Care and Use of Laboratory Animals* (NRC, 1996) recommends that an oversight committee (safety committee) should be developed as part of a facility's occupational safety and health plan. Training and compliance within the area of WAG safety could become a function of this committee. A study has shown that the adoption of such a training program can reduce the WAG concentrations to below the levels recommended by NIOSH and OSHA (McGregor, 2000).

2. Work Practices to Decrease Emissions

Although several effective methods for reductions of WAG exposure have been described, it has been estimated that up to 94% of WAG emissions (in adequately scavenged anesthetic environments) were the direct result of poor work practices of the personnel performing anesthesia (NIOSH, 1977). Recommended work practices have been described by NIOSH (1977), OSHA (2000), ASA (1999), and ACVA (1996). A brief summary of these work practices, as they specifically relate to the laboratory animal environment, is included in Table 7-4.

One work practice technique that could significantly reduce WAG pollution in the laboratory animal setting is regular adoption of intubation. Intubation of the trachea for anesthetic delivery replaces the need for ill-fitting face-mask delivery of anesthetic gases. Smith and Bolon (2005) reported significant WAG leakage from various rodent face masks, and describe a simple modification using a latex glove gasket (Fig. 7-3). Although several techniques have been described for intubating rodents with traditional (reviewed in Rivera et al., 2005) and novel (Imai et al., 2005) airway devices, this is not widely practiced. Most studies list patient anatomy and small size, the need for advanced training techniques, and the need for specialized visual equipment as reasons why rodent intubation has not become standard practice. Concerns about intubation are not usually an issue with larger laboratory animal species (dogs, pigs, primates, and rabbits), as they are generally more easily intubated. One alternative to intubation and face-mask techniques is the laryngeal mask airway (LMA), which has been described for use in several laboratory species (Imai et al., 2005) including the rabbit (Bateman et al., 2002; Long et al., 2003).

TABLE 7-4

SUMMARY COMMENTS OF WORK PRACTICES TO REDUCE OCCUPATIONAL EXPOSURE TO WAG IN THE LABORATORY ANIMAL ENVIRONMENT

- Functional WAG-scavenging system in place *prior* to starting anesthetic event
- Follow a regular maintenance schedule for all anesthetic equipment
 - High and low pressure-leak testing *prior* to each use
 - Proper filling and draining of vaporizer (agent-specific key fill device)
 - Annual assessment of system and tri-annual calibration of the vaporizer
- Comprehensive medical surveillance program for *all* personnel working with WAG
- Comprehensive training program for *all* personnel working with WAG
- Refrain from techniques that will unnecessarily expose personnel to WAG
 - Starting anesthetic gas *prior* to connection with patient
 - Disconnecting system with anesthetic gas on
 - Opening liquid anesthetic bottle without proper ventilation
 - Liquid anesthetic spills
- Use of induction box should be limited to:
 - Purging, snorkel devices, active scavenging or fume hood
- Use of "newer" techniques whenever possible
 - Low flow anesthesia
 - Intubation of rodents
 - Replace facemasks with tighter seals, or alternative (LMA) devices
- Compliance mandates for WAG usage
 - Involve safety committee, occupational health group
- Comprehensive air-monitoring program
 - Use several monitoring modalities
 - Bi-annual monitoring and periodic sampling when necessary
 - Record keeping



Fig. 7-3 Example of simple engineering controls that could be utilized to mitigate occupational exposure to WAG in the research setting: a homemade diaphragm is manufactured from the thumb portion of a small latex surgical glove. The thumb is removed using scissors and then stretched over the orifice of a conventional conical rodent face mask, creating a small (0.5- to 0.8-cm long) aperture just large enough to contain the animal's nose.

A study comparing the WAG emissions from rabbits fitted with either an endotracheal tube (cuffed and uncuffed) or an LMA found the latter to emit a third more WAG into the environment (Smith et al., 2004). The use of LMAs as an alternative to intubation in smaller laboratory species may be an easier technique to master, but its WAG emission profile should also be considered.

Another work practice that has successfully been employed to decrease WAG pollution in the environment is low-flow anesthesia (Byhahn et al., 2001; Imberti et al., 1995). This practice involves delivery of fresh gas at a rate equal to the uptake of anesthetic gases and oxygen by the patient (Dorsch and Dorsch, 1999). This technique is considered to be a safe, practical, and cost-effective way to deliver inhalant anesthetics, although its WAG-reducing advantages have largely been ignored. Imberti et al. (1995) showed that low-flow anesthesia, coupled with active WAG scavenging, caused a significant reduction in WAG emissions. Similarly, in the laboratory animal setting, the use of low-flow anesthesia was shown to reduce WAG emissions two- to five-fold over traditional high-flow techniques commonly utilized in canine anesthesia (Smith and Bolon, 2004).

VI. SUMMARY AND CONCLUSIONS

Information gained over the past 40 years shows that WAG would be emitted into the environment if volatile anesthetic agents are used. Furthermore, research has shown that this is likely within the laboratory animal research environment. However, work practices, training, and WAG-monitoring programs can be followed that decrease the amount of WAG in the environment, thereby leading to a safer work setting. The reader is referred to Table 7-4 for a summary of recommended work practices.

The laboratory animal worker is uniquely tasked with conducting anesthesia in a wide variety of species, many of which are small. Their small body size makes routine techniques used in human medicine (e.g., intubation) difficult. Therefore, an induction box, face mask, and higher carrier-gas flow rates are often used. A further challenge facing the laboratory animal anesthetist is the current practice of high-throughput surgery, making multiple patient anesthetics a common occurrence. All of these techniques increase WAG pollution in the laboratory animal setting.

Of the hundreds of studies published on WAG pollution, fewer than 25 were conducted specifically in the veterinary or laboratory animal environment. Although much of what has been written in the human literature can be extrapolated to the veterinary setting, more scientific studies specifically relating to this field should be undertaken. Such literature would lead to continued improvements in risk mitigation of the potential occupational hazards related to volatile anesthetic practices.

REFERENCES

American College of Veterinary Anesthesiologists (ACVA). (1996). Commentary and recommendations on control of waste anesthetic gases in the workplace. *JAVMA* **209**, 75–77. <http://www.acva.org/professional/Position/waste.htm> (last accessed December 2006).

Ad Hoc Committee of the American Society of Anesthesiologists. (1974). Occupational disease among O. R. personnel: A national study. *Anesthesiology* **41**, 321–340.

American Society of Anesthesiologists (ASA). (1999). "Information for Management in Anesthetizing Areas and Postanesthesia Care Unit (PACU)." American Society of Anesthesiologists, Park Ridge, IL. <http://www.asahq.org/publicationsAndServices/wasteanes.pdf> (last accessed December 2006).

Bateman, L.J., Ludders, W., and Gleed, R.D. (2002). Use of a laryngeal mask airway in rabbits during isoflurane anesthesia. Proceedings of the Annual Meeting of American College of Veterinary Anesthesiologists, p 30, Orlando, FL.

Best, J.L., and McGrath, C.J. (1977). Trace anesthetic gases: An overview. *JAVMA* **171**, 1268–1269.

Boivin, J.F. (1997). Risk of spontaneous abortion in women occupationally exposed to anaesthetic gases: A meta-analysis. *Occup. Environ. Med.* **54**, 541–548.

Bruce, D.L., and Linde, H.W. (1972). Halothane content in recovery room air. *Anesthesiology* **36**, 517–518.

Buring, J.E., Hennekens, C.H., Mayrent, S.L., Rosner, B., Greenberg, E.R., and Colton, T. (1985). Health experiences of operating room personnel. *Anesthesiology* **62**, 325–330.

Burkhart, J.E., and Strobe, T.J. (1990). Real-time measurement and control of waste anesthetic gases during veterinary surgeries. *Am. Ind. Hyg. Assoc. J.* **51**, 640–645.

Burm, A.G. (2003). Occupational hazards of inhalational anesthetics. *Best Pract. Res. Clin. Anesthesiol.* **17**, 147–161.

Byhahn, C., Westphal, K., and Strouhal, U. (1998). Exposure of pregnant recovery room and surgical intensive-care unit personnel to inhalational anesthetics. *Gesundh. Wes.* **60**, 586–591.

Byhahn, C., Wilke, H.J., and Westphal, K. (2001). Occupational exposure to volatile anesthetics: Epidemiology and approaches to reducing the problem. *CNS Drugs* **15**, 197–215.

Corbett, T.H., and Ball, G.L. (1971). Chronic exposure to methoxyflurane: A possible occupational hazard to anesthesiologists. *Anesthesiology* **34**, 532–537.

Dreesen, D.W., Jones, G.L., Brown, J., and Rawlings, C.A. (1981). Monitoring for trace anesthetic gases in a veterinary teaching hospital. *JAVMA* **179**, 797–799.

Dorsch, J.A., and Dorsch, S.E. (1999). Controlling trace gas levels. In "Understanding Anesthesia Equipment." 4th ed., pp 355–398. Williams & Wilkins, Baltimore, MD.

Foley, K. (1993). AANA journal course: Update for nurse anesthetists—occupational exposure to trace anesthetics: Quantifying the risk. *J. Am. Assoc. Nurse Anesth.* **61**, 405–412.

Gardner, R.J., Hampton, J., and Causton, J.S. (1991). Inhalation anesthetics—exposure and control during veterinary surgery. *Ann. Occ. Hyg.* **35**, 377–388.

Goerig, M., and Pothmann, W. (2004). Anaesthetic gas pollution at the workplace: An ancient problem associated with inhalation anaesthesia. *Anesthesiol. Intensivmed.* **45**, 572–577.

Hoerauf, K., Lierz, M., Wiesner, G., Schroegendofer, K., Lierz, P., Spacek, A., Brunner, L., and Nusse, M. (1999). Genetic damage in operating room personnel exposed to isoflurane and nitrous oxide. *Occup. Environ. Med.* **56**, 433–437.

Hoerauf, K., Wiesner, G., Funk, W., Schroegendorfer, K., and Hobbhahn, J. (1997). Biological monitoring during occupational exposure to isoflurane and sevoflurane. *Zentbl. Hyg. Umweltmed.* **200**, 521–529.

Imai, A., Eisele, P.H., and Steffey, E.P. (2005). A new airway device for small laboratory animals. *Lab. Anim.* **39**, 111–115.

Imberti, R., Preseglio, I., Imbriani, M., Ghittori, S., Cimino, F., and Mapelli, A. (1995). Low flow anaesthesia reduces occupational exposure to inhalation anesthetics. *Acta Anaesthesiol. Scand.* **39**, 586–591.

Johnson, J.A., Buchan, R.M., and Reif, J.S. (1987). Effect of waste anesthetic gas and vapor exposure on reproductive outcome in veterinary personnel. *Am. Ind. Hyg. Assoc. J.* **48**, 62–66.

- Kelling, G. (1918). Über die Beseitigung der Narkosedämpfe aus dem Operationssaale. *Zentralbi. Chir.* **45**, 602–606.
- Lecky, J.H. (1977). The mechanical aspects of anesthetic pollution control. *Anesth. Analg.* **56**, 760–774.
- Long, J.P., Ngala, V.R., and Foresman, L.L. (2003). The use of a laryngeal mask airway (LMA) in the rabbit: An alternative to endotracheal intubation. *Contemp. Top.* **42**, 92 [Abstract P030].
- Manley, S.V., and McDonnell, W.N. (1980a). Anesthetic pollution and disease. *JAVMA* **176**, 515–518.
- Manley, S.V., and McDonnell, W.N. (1980b). Recommendations for reduction of anesthetic gas pollution. *JAVMA* **176**, 519–524.
- Marx, T. (1999). Global pollution: The anaesthetist's contribution. *Anaesthesia*. **54**, 301–302.
- Marx, T., Schmidt, M., Schirmer, U., and Reinelt, H. (2001). Pollution of the environment and the workplace with anesthetic gases. *Int. Anesthesiol. Clin.* **39**, 15–27.
- McGregor, D.G. (2000). Occupational exposure to trace concentrations of waste anesthetic gases. *Mayo Clin. Proc.* **75**, 273–277.
- McKelvey, D., and Hollingshead, K.W. (2003). Workplace safety. In "Veterinary Anesthesia and Analgesia." pp 217–237. Mosby Elsevier Science, St. Louis, MO.
- Milligan, J.E., and Saban, J.L. (1982). Waste anesthetic gas concentrations in a veterinary recovery room. *JAVMA* **181**, 1540–1541.
- National Institute of Occupational Safety and Health (NIOSH). (1977). "Criteria for a Recommended Standard: Occupational Exposure to Waste Anesthetic Gases and Vapors," DHEW Publication No. 77-140. NIOSH/CDC, Washington, D.C.
- National Institute of Occupational Safety and Health (NIOSH). (1994). "NIOSH Alert: Controlling Exposure to Nitrous Oxide During Anesthetic Administration," DHEW Publication No. 94-100. NIOSH/CDC, Washington, D.C.
- National Research Council (NRC). (1996). Institutional policies and responsibilities. In "Guide for the Care and Use of Laboratory Animals." pp 8–20. National Academy Press, Washington, D.C.
- National Research Council (NRC). (1997). Physical, chemical and protocol-related hazards. In "Occupational Health and Safety in the Care and Use of Research Animals." pp 32–50. National Academy Press, Washington, D.C.
- Rivera, B., Miller, S.R., Brown, E.M., and Price, R.E. (2005). A novel method for endotracheal intubation of mice and rats used in imaging studies. *Contemp. Top.* **44**, 52–55.
- Ruby, D.L., Buchanan, R.M., and Gunter, B.J. (1980). Waste anesthetic gas and vapor exposures in veterinary hospitals and clinics. *AmInd. Hyg. Assoc. J.* **41**, 229–231.
- Sawyer, D.C. (1976a). A personal hazard: Operating room environmental pollution. *J. Am. Anim. Hosp. Assoc.* **12**, 214–217.
- Sawyer, D.C. (1976b). A personal hazard: O. R. environmental pollution. *Vet. Anesthesiol.* **3**, 73–77.
- Sessler, D.I., and Badgwell, J.M. (1998). Exposure of postoperative nurses to exhaled anesthetic gases. *Anesth. Analg.* **87**, 1083–1088.
- Smith, J.A. (1993). Anesthetic pollution and waste anesthetic gas scavenging. *Semin. Vet. Med. Surg.* **8**, 90–103.
- Smith, J.C., and Bolon, B. (2002). Atmospheric waste isoflurane concentrations using conventional equipment and rat anesthesia protocols. *Contemp. Top.* **41**, 10–17.
- Smith, J.C., and Bolon, B. (2003). Comparison of three commercially available activated charcoal canisters for passive scavenging of waste isoflurane during conventional rodent anesthesia. *Contemp. Top.* **42**, 10–15.
- Smith, J.C., and Bolon, B. (2004). Waste anesthetic gas during canine anesthesia: Comparison of isoflurane levels emitted under high and low flow carrier gas rates. Proceedings of the 55th Annual Meeting of the American Association of Laboratory Animal Science, October 17–21, 2004, p 101, Tampa, FL [Abstract PS30].
- Smith, J.C., and Bolon, B. (2005). Isoflurane leakage from non-rebreathing rodent anaesthesia circuits: Comparison of emissions from conventional and modified ports. *Lab. Anim.* **40**, 200–209.
- Smith, J.C., Robertson, L.D., Auhll, A., March, T.J., Derring, C., and Bolon, B. (2004). Endotracheal tubes versus laryngeal mask airways in rabbit intubation anesthesia: Ease of use and waste gas emissions. *Contemp. Top.* **43**, 22–255.
- Soontranan, P., Somprakit, P., Lertakyamane, J., and Surachetpong, S. (2002). A survey of the anesthesia scavenging systems in a teaching hospital. *J. Med. Assoc. Thai.* **83**(Suppl 3), 24–29.
- United Nations. (1987). The 1987 Montreal Protocols on Substances That Deplete the Ozone Layer. United Nations, New York. <http://www.unido.org/doc/5072> (last accessed December 2006).
- U.S. Occupational Safety and Health Administration (OSHA). (2000). Anesthetic gases: Guidelines for workplace exposures. <http://www.osha.gov/dts/osta/anestheticgases/index.html> (last accessed December 2006).
- Vaisman, A.I. (1967). Working conditions in surgery and their effect on the health of anesthesiologists. *Eksp. Khir. Anesteziol.* **3**, 44–49.
- Ward, G.S., and Byland, R.R. (1982a). Concentrations of methoxyflurane and nitrous oxide in veterinary operating rooms. *Am. J. Vet. Res.* **43**, 360–362.
- Ward, G.S., and Byland, R.R. (1982b). Concentration of halothane in veterinary operating and treatment rooms. *JAVMA* **180**, 174–177.
- Wingfield, W.E., Ruby, D.L., Buchan, R.M., and Gunther, B.J. (1980). Waste anesthetic gas exposures to veterinarians and animal technicians. *JAVMA* **178**, 399–402.

This page intentionally left blank

Strategies for Assessing and Minimizing Pain

Alicia Z. Karas, Peggy J. Danneman, and Joan M. Cadillac

I. Introduction	195
II. Why Prevent Pain?	196
A. Pain Perception in Animals	196
B. Pain and Stress	197
C. Other Physiological Effects of Pain	197
III. Preprocedural Considerations: Predicting and Preventing Pain	199
A. Types of Pain	199
B. Severity of Pain	200
C. Strategies for Minimizing Pain	203
IV. Postprocedural Considerations: Recognizing and Monitoring Pain	206
A. When and How Often to Monitor?	206
B. Behavioral Assessment of Pain	206
C. Other Indicators of Pain	212
D. Novel Methods of Monitoring Pain	213
V. Summary	213
References	213

I. INTRODUCTION

Pain hurts. Everyone can agree on this simple truth, but identifying pain has proven challenging, and measuring it considerably more challenging yet. Although pain consists in part of purely physical sensation, the truly unpleasant aspects of it are all in the mind. As a result, pain is a uniquely individual experience and it is difficult, if not impossible, for us to fully understand the pain even of others. When viewed in this light, the problems inherent in trying to measure pain in animals are

evident. In fact, it is best to admit from the start that we cannot measure pain in animals with anything even approaching precision (ACLAM, 2006; Anil et al., 2002; Carstens and Moberg, 2000; Mathews, 2000; Underwood, 2002; Wixson, 1999). Notwithstanding our limitations in this regard, veterinarians and investigators have both a moral and legal obligation to prevent or minimize animal pain to the maximum extent consistent with scientific goals. To do so requires the ability to recognize, or to predict, the need for intervention as well as knowledge of the most effective forms of intervention. The effective treatment of

pain requires appreciation of the many different types of pain, as they may respond quite differently to specific therapeutic regimens, a thorough understanding of species-specific (and sometimes strain-specific) behavior, and a general understanding of pain physiology. This chapter begins with a discussion of the reasons—ethical, regulatory, and scientific—why the minimization of pain in experimental animals must be viewed as an essential element of scientific investigation. The remainder of the chapter focuses on the steps that can be taken during the preprocedural planning phase to prevent or reduce pain, the strategies that can be used after the procedure to recognize pain, and the need for additional intervention to relieve it. Some novel methods for monitoring pain during the postprocedural period are reviewed at the end of the chapter.

II. WHY PREVENT PAIN?

A. Pain Perception in Animals

The perception of pain requires initial detection of the stimulus by nociceptors, processing through peripheral and spinal cord pathways, and final processing through higher centers in the brain, including the cerebral cortex (see Chapter 1 for a more detailed review). However, mere conscious awareness of a stimulus is not equivalent to recognizing it as painful. At levels of stimulation just adequate to activate nociceptors, humans will report an awareness of sensation but will not describe the sensation as painful. This is referred to as the *nociceptive threshold*. Higher levels of stimulation are required to reach the *pain detection threshold*, which is the least experience of pain that a subject can recognize as painful (IASP, 1994). Under carefully controlled conditions, both the nociceptive and pain detection thresholds are fairly consistent among different subjects. The highest experimentally defined level of pain perception is the *pain tolerance threshold*. This is the highest level of pain that a human subject is willing to tolerate (IASP, 1994). It is highly variable not only between subjects but also in the same subject at different times. At the lower end of the pain sensitivity range, the cognitive and emotional responses that characterize the stimulus as *aversive* (provoking avoidance or escape) are weak (Chapman et al., 1985; Dubner, 1994; NRC, 1992). As the stimulus intensity increases, these responses become stronger. It is the cognitive and emotional components of pain that contribute to the wide variability in the pain tolerance threshold.

What does pain perception mean in an animal? Do animals feel pain in the same way as humans? The answer is that we do not know. We do know that the neurological mechanisms for processing nociceptive (painful) information are quite similar in humans and other mammals (Bonica, 1992; Gebhart, 1994). We also know that the stimulus intensities required to activate these mechanisms are remarkably similar for humans and other mammals (Kitchell, 1987). However, because we cannot measure

the all-important cognitive and emotional components of pain in animals, it is not possible to determine whether an animal perceives a noxious stimulus as unpleasant in the same way and to the same extent as a human would. Despite our inability to measure all aspects of the pain experience in animals, the assumption must nonetheless be made that nonhuman mammals have the capacity to perceive as unpleasant the same noxious stimuli that humans perceive as unpleasant. This assumption is reinforced by observations that mammals exhibit behavioral and physiological responses to noxious stimulation that are similar to those exhibited by humans and, like humans, these animals will work harder to escape more intense stimulation (Dubner, 1994; Kitchell, 1987). Animals of even the most “stoic” species show altered patterns of behavior and physiological disturbances for several hours or days following simple invasive procedures (Anil et al., 2005; Blackburn-Munro, 2004; Carroll et al., 2006; Kent et al., 2000; Liles et al., 1998; Malavasi et al., 2006; Molony and Kent, 1997; Rady et al., 1993; Roughan and Flecknell, 2004; Thuer et al., 2007; Ting et al., 2003a, 2003b) and for up to several weeks following procedures that result in more significant or prolonged tissue damage (Anil et al., 2005; Molony and Kent, 1997). The belief that these changes are related to pain is supported by observations that the behavioral changes, as well as many of the physiological changes that occur after injury, can be reduced or eliminated by analgesic drugs.

The situation is less clear in phylogenetically more primitive animals (lower vertebrates and invertebrates). Even very primitive vertebrates have peripheral nociceptors and neural pathways that correspond to those involved in nociceptive processing in mammals. However, the cerebral cortex in these animals is either poorly developed or nonexistent, and the brainstem centers of the lower vertebrates lack the organization and complexity of these structures in mammals (Stevens, 1995). A functioning cerebral cortex is considered by many to be a basic requirement for noxious stimuli to be recognized as painful (Anonymous, 2001; Kitchell, 1987). Thus, it could be argued that lower vertebrate and invertebrate animals are not able to perceive noxious stimuli as unpleasant in the same manner mammals do (Stevens, 1995). However, these animals do show physiological and behavioral responses to noxious stimulation, including avoidance or escape behaviors (Arena and Richardson, 1990; NRC, 1992; Sneddon et al., 2003). This indicates that, at the very least, noxious stimulation can be a potent stressor for more primitive animals.

Given the evidence that animals are able to experience pain in much the same way as humans when exposed to noxious stimuli, do veterinarians and scientists have an obligation to limit such exposures, or to take steps to minimize the unpleasant outcomes, in experimental animals? On both ethical and regulatory grounds, the answer is “yes.” Even among those groups that most actively support the use of animals in research, there is virtually unanimous agreement on three points: (1) the benefits of the research must outweigh the costs (including costs in animal suffering); (2) all relevant regulations and guidelines must be

followed; and (3) animal subjects must be treated humanely, including minimization of pain and distress to the extent consistent with scientific goals (Animals in Research Committee, 1988; Anonymous, 2006; Carroll, 2005; Castello, 2003; Zimmermann, 1983, 1986). Thus, even with more primitive animals that may not experience pain in the same way as humans, the most humane alternative is to minimize noxious stimulation or interfere with its processing with anesthetics or analgesics. More in-depth explorations of the ethical and regulatory issues related to the prevention and alleviation of pain in research animals are presented elsewhere in this text.

B. Pain and Stress

Like pain, *stress* is a concept that eludes precise definition. Dorland (1981) defines it as “the sum of the biological reactions to any adverse stimulus, physical, mental, or emotional, internal or external, that tends to disturb the organism’s homeostasis.” The biological reactions that comprise the stress response include behaviors, changes in autonomic function, and changes in neuroendocrine function. These reactions allow the organism to adapt to the perceived stimulus and return to a state of equilibrium. If the organism is unable to adapt, a state of *distress* ensues. Distress is characterized by maladaptive, often overtly harmful, behavioral and/or physiological changes. The adverse stimuli that provoke a stress response are called *stressors*. As Dorland’s definition of stress implies, almost anything can be a stressor, and a stressor for one animal may not be a stressor for another. Similarly, the response to a stressor may vary both qualitatively and quantitatively from one animal to another, or in the same animal at different times.

Acute stressors trigger the release of corticotropin-releasing factor (CRF) from the hypothalamus. CRF causes the pituitary to secrete adrenocorticotropic hormone (ACTH), which, in turn, stimulates the adrenal cortex to release glucocorticoids (cortisol and corticosterone). These hormones cause (1) enhanced hepatic gluconeogenesis; (2) inhibition of glucose uptake by tissues; (3) enhanced lipid and protein catabolism; (4) altered function of macrophages, lymphocytes, and neutrophils; and (5) stimulation of tissue lipocortin production. Lipocortins inhibit the inflammatory response by, among other things, inhibiting production of prostaglandins, thromboxanes, and leukotrienes (Breazile, 1987). The response to stress also involves increased sympathetic tone, which causes (1) reduced secretion of insulin by the pancreatic islet cells; (2) increased release of renin by the kidneys; (3) increased release of vasoactive intestinal peptide by the intestine; (4) increased release of substance P; (5) increased production of inflammatory cytokines, including tumor necrosis factor- α , interleukin-1, and interleukin-6; and (6) increased secretion of catecholamines from the adrenal medulla and sympathetic nerve terminals. Changes in the plasma concentrations of these substances result in changes in carbohydrate, protein, and fat metabolism; alterations in fluid, electrolyte, and

acid–base balance; and changes in cardiovascular, gastrointestinal, renal, and immune function (Fisher, 2002; Fisher et al., 1997a, 1997b). Clinical signs of repeated or prolonged stress may include delayed wound healing, muscle wasting, immune deficiencies, enhanced susceptibility to infection, stimulation or inhibition of feeding behavior, gastrointestinal bloating, and/or diarrhea (Breazile, 1987; Eijkelkamp et al., 2007; Lewis et al., 1994; NRC, 1992).

Pain is a stressor that can have different effects on the organism depending on many factors, including severity and duration. Brief or mild pain provokes an adaptive response, whereas severe or prolonged pain is more likely to provoke a physiologically harmful response. For example, while brief pain may stimulate the secretion of β -endorphin and enhance the cytotoxic capacity of natural killer (NK) cells, more severe or prolonged pain may result in a significant decrease in NK cell cytotoxicity (Fisher, 2002). Pain may also interact with other stressors (e.g., fear, cold, hunger, and dirty environment) to produce an augmented stress response. This interaction may be of particular importance in clinical situations where pain is a component of the organism’s response to conditions such as traumatic injury, surgery, or sepsis. For example, postoperative pain in humans and animals has been demonstrated to amplify the stress-induced response to injury, resulting in delayed wound healing, increased metabolic rate, accelerated loss of body protein, negative nitrogen balance, hyperglycemia, and disturbances in plasma electrolytes. Many, but not necessarily all, of these changes can be reduced or eliminated by effective control of surgical pain (Brandt et al., 1978; Kehlet, 2006; Kehlet and Dahl, 2003; Lewis et al., 1994; McGuire et al., 2006; White et al., 2007; Yeager et al., 1987). Pain control is important in managing the severely injured, seriously ill, or postsurgical patient; it is also important to recognize that the purpose of the stress response is to restore hemodynamic and metabolic homeostasis. Analgesics, particularly the opioid agonists, may interfere with this response and should be used judiciously with full awareness of all of their potential clinical and physiological effects (Molina, 2006).

C. Other Physiological Effects of Pain

Besides the general physiological changes associated with stress, pain has been shown to have specific effects on wound healing, behavior, and metabolism, and on immune, pulmonary, cardiac, gastrointestinal, and urinary tract function. Pain may also have more general effects on the speed of recovery from surgery and even on survival. Studies in humans have shown that superior pain control is associated with significantly reduced morbidity, quicker wound healing, a more rapid return to normal function, and a higher short-term survival rate following surgery (Brandt et al., 1978; Cullen et al., 1985; Lewis et al., 1994; McGuire et al., 2006; Scott and Kehlet, 1988; Yeager et al., 1987). Better pain management is associated with faster

recovery, as indicated by earlier extubation, earlier ambulation, and shorter stays in the intensive care unit, hospital, and rehabilitation (Bonnet and Marret, 2005; de Leon-Casasola et al., 1994; Lewis et al., 1994). There have been many studies of the effects of pain on food intake, body weight, long-term behavior, and functioning of the immune, respiratory, cardiovascular, and gastrointestinal systems. Most of these studies have been performed on human surgical patients, but results from a smaller number of animal studies suggest that the findings in humans are generally applicable to animals.

1. *Effects on Food Intake and Body Weight*

Surgery and other painful procedures performed without the use of supplemental analgesics have been demonstrated to cause reductions in activity and feed consumption and loss of body weight in several species, including rats (Flecknell et al., 1999; Liles et al., 1998; Page et al., 1993), cattle (Fisher, 2002; Fisher et al., 1997a, 1997b; Ting et al., 2003a, 2003b), and swine (Malavasi et al., 2006). These negative effects can be reduced or eliminated with the use of local anesthetics or pre- and/or postoperative analgesics (Fisher, 2002; Fisher et al., 1997a, 1997b; Flecknell et al., 1999; Jablonski et al., 2001; Liles et al., 1998; Malavasi et al., 2006; Page et al., 1993; Ting et al., 2003b). It should be noted, however, that considerable variability has been found in the ability of analgesic treatment to reduce the adverse effects of surgery on activity, feed consumption, and body weight. Depending on the drug used, route of administration, and dosing regimen, analgesics may be highly effective, partially effective, ineffective, or even detrimental in this regard (Flecknell et al., 1999; Jablonski and Howden, 2002; Jablonski et al., 2001; Jacobson, 2000; Liles et al., 1998; Page, 2005; Sharp et al., 2003; Ting et al., 2003b).

2. *Behavioral Effects*

The long-term effects of unrelieved pain have been studied most extensively in neonatal humans and animals. Repeated exposure of human neonates, especially those born prematurely, to painful procedures results in altered development of neural systems subserving pain perception and stress arousal (Grunau et al., 2005). Repeated pain exposure in infancy also predisposes children to long-term attention, learning, and behavior problems (Grunau et al., 2005; Whitfield and Grunau, 2000). Exposure of rat pups to a mild pain stimulus (needle prick) several times a day for the first week of life resulted in increased sensitivity to pain, an increased preference for alcohol, and increased anxiety on several behavioral tests when the animals were tested as adults (Anand et al., 1999). In a similar study, there was no immediate effect on the stress responsiveness of rat pups exposed to repeated needle pricks, but there was a significant increase in maternal grooming of these pups. It was hypothesized that the increased maternal care attenuated the stress response in the pups (Walker et al., 2003). Humans

suffering from cancer or chronic pain syndromes often suffer disrupted sleep patterns, and may experience inappropriate cognitions and disruptions in mood and/or social functioning. They are also at high risk of depression (Blackburn-Munro, 2004; Siddall and Cousins, 2004) and disabling fatigue (Brown et al., 2005; Stone et al., 2000). Similar abnormalities in sleep patterns are observed in experimental rat models of polyarthritis and neuropathy (Blackburn-Munro, 2004), and treatment of arthritic rats with analgesics has been shown to improve their performance on operant tasks measuring concentration and memory (Cain et al., 1997; Lindner et al., 1999). Uncontrolled postoperative pain in humans has been related to an increased predisposition to the development of chronic pain syndromes, and more effective postoperative pain management has been related to a reduced incidence of chronic pain following thoracotomy (Bonnet and Marret, 2005).

3. *Immune Effects*

Postoperative pain has been shown to negatively influence immune function in humans and animals undergoing surgery. Suppression of mitogen-induced lymphocyte proliferation and an increase in production of IL-1 β and IL-6 occurred in all patients in one study (Beilin et al., 2003). However, compared with those who reported greater postoperative pain, patients who reported the least postoperative pain showed smaller changes in these parameters. In humans undergoing root canal surgery, an observed postprocedural decrease in NK cell cytotoxicity was correlated with a higher incidence of respiratory illness during the 2 weeks following surgery (Logan et al., 2001). Acute nonsurgical pain in experimental animals has also been demonstrated to inhibit the cytotoxic activity of NK cells (Liebeskind, 1991; Shanin et al., 2005). Surgery, but not anesthesia alone, increased the number of lung metastases in rats inoculated IV with mammary adenocarcinoma tumor cells shortly after surgery. This effect was correlated with a postsurgical decrease in NK cell cytotoxicity. The effect of surgery on tumor spread was significantly reduced by morphine or fentanyl administered pre- and postoperatively, or by bupivacaine administered intrathecally (IT) before surgery combined with morphine postsurgery (Page et al., 1993, 2001). None of these treatments had any effect on tumor metastasis in nonoperated rats, although fentanyl suppressed NK cell cytotoxicity in the nonoperated animals (Page et al., 1993, 2001). In another study using the same tumor model, postoperative buprenorphine treatment significantly reduced tumor metastasis, but neither fentanyl nor morphine had a significant effect. In this study, both morphine and fentanyl significantly reduced NK cell activity in nonoperated animals, whereas buprenorphine had no effect (Franchi et al., 2007). Chronic pain associated with experimentally induced mononeuropathy in rats was accompanied by increased delayed-type hypersensitivity and a decreased IgG response to keyhole limpet hemocyanin (KLH). A smaller decrease in the IgG response to KLH was observed

in sham-operated rats; these smaller changes were attributed to stress associated with surgery and acute pain (Herzberg et al., 1994).

4. *Pulmonary Effects*

In humans, and undoubtedly in animals also, pain involving the upper abdomen or thorax causes a pattern of rapid, shallow breathing with reduced or absent deep breaths. This leads to reduced vital capacity, tidal volume, and functional residual capacity, which, in turn, predisposes the patient to atelectasis, hypoxemia, hypercarbia, retention of pulmonary secretions, and pulmonary infections (Cullen et al., 1985; IASP, 1992; Lewis et al., 1994). Superior postoperative pain control in humans is associated with improved postoperative pulmonary function and reduced pulmonary complications, including respiratory failure (Ballantyne et al., 1998; Bonnet and Marret, 2005; Dabu-Bondoc, 2004).

5. *Cardiovascular Effects*

Pain-induced sympathetic stimulation causes vasoconstriction and increased heart rate, stroke volume, cardiac output, myocardial oxygen consumption, and blood pressure (IASP, 1992; Lewis et al., 1994). Increased effectiveness of postoperative pain management is associated with improved cardiovascular function, decreased incidence of postoperative myocardial infarction and stroke, a decreased incidence of deep vein thrombosis and pulmonary embolism, and improved tissue oxygen tension (Akca et al., 1999; Bonnet and Marret, 2005; Farag et al., 2005; Lewis et al., 1994; Rosenberg, 2000). In anesthetized pigs, mortality rates were higher and compensatory cardiovascular responses were reduced when the animals were subjected to experimental hemorrhage plus a nociceptive afferent stimulus versus hemorrhage alone (Foex et al., 2004). Addition of a nociceptive stimulus also augmented hemorrhage-induced reductions in oxygen delivery and oxygen consumption (Rady et al., 1991). Even greater effects on cardiac function and oxygen delivery were seen when the anesthetized animals were subjected to significant skeletal muscle injury in addition to hemorrhage (Rady et al., 1993).

6. *Gastrointestinal and Urinary Tract Effects*

Nociceptive impulses from viscera and somatic structures can lead to ileus, nausea and vomiting, and hypomotility of the urethra and bladder in humans and animals (Bustorff-Silva et al., 1999; Fukuda et al., 2006; IASP, 1992; Rady et al., 1993; Uemura et al., 2004). Effective postoperative pain management in humans is associated with a more rapid return to normal function. Newer opioid analgesics and multimodal, opioid-sparing analgesic regimens are particularly effective in reducing postoperative gastrointestinal and urinary complications, including ileus, in humans and animals (Carli et al., 2001; De Winter et al.,

1997; Fukuda et al., 2006; Kehlet and Holte, 2001; Rosenberg, 2000; Saclarides, 2006; Sinatra, 2006; White et al., 2007).

III. PREPROCEDURAL CONSIDERATIONS: PREDICTING AND PREVENTING PAIN

If the objective is to improve animal welfare and scientific outcome by minimizing pain, the greatest benefit is derived by predicting the likelihood of its occurrence and anticipating the steps that will be needed to prevent or control it. It is necessary to estimate the degree of pain that an animal is likely to experience during or after specific experimental procedures for several reasons. Prediction of the type and extent of pain that is possible allows crafting of suitable analgesic regimens, supportive therapy measures, and criteria for triggering intervention with euthanasia. Also, if the extent of pain as well as the potential for controlling it is not correctly anticipated, then a study might be incorrectly assigned to a United States Department of Agriculture (USDA) pain/distress category, an important consideration during Institutional Animal Care and Use Committee (IACUC) review. Such estimates are optimally based on the incidence and severity of pain-related clinical signs that have been observed in other animals and humans subjected to the same or similar procedures. In general, it is valid to assume that procedures and conditions that cause pain in humans are likely to cause pain in animals. In fact, the U.S. Government Principles for the Utilization and Care of Vertebrate Animals Used in Testing, Research, and Training require investigators to make such assumptions in the absence of any evidence to the contrary (Public Health Service, 1996).

A considerable amount of information is available relating tissue injury to histologic, neurologic, and biobehavioral changes in animal models and humans. Pain can arise from injury to somatic tissues, the viscera, or nervous tissue, but can paradoxically occur in some cases in the absence of apparent noxious stimuli. The neurological mechanisms underlying pain arising from these tissues vary, as do the characteristics of the pain and its response to specific therapeutic regimens. Pain also may be classified as acute or chronic and these two types of pain often have different underlying causes and respond differently to treatment. All of these differences relate to the way in which pain is processed within the nervous system, and a basic understanding of the neurophysiology of pain is essential to prediction, diagnosis, and effective treatment of different types of pain. A brief mention of the basic types of pain follows, but the reader is encouraged to refer to Chapter 1 of this volume for a detailed review.

A. *Types of Pain*

The specific type of pain experienced may determine the symptoms exhibited by the animal, and signs common with one

kind of pain may not be seen with another. In addition, the time course and type of pain will determine the type and duration of treatment. Nonpain factors may figure in a given disease model as well, for example, the impact of analgesic therapy on comfort might be greatly augmented by fluid and thermal support in a sepsis model.

1. *Acute Versus Chronic Pain*

Acute pain results from both nondamaging or tissue-damaging events and the duration varies from seconds to days. When tissues are injured, acute pain appears to resolve as repair proceeds. Acute pain can also fail to resolve and become chronic, but chronic pain may instead be insidious in origin. Many different conditions and syndromes are associated with chronic pain, including malignancies, chronic inflammatory disorders (e.g., cholecystitis and colitis), and orthopedic disorders (e.g., spinal stenosis and osteophytes).

Chronic pain is imprecisely defined in humans and animals but it is generally regarded as present when it outlasts the normal healing course of an injury; in humans it has been documented to continue for months to years after certain types of surgeries. Postsurgical chronic pain in one meta-analysis was estimated to occur in 11–81% of patients after amputation of limbs, thoracotomy, mastectomy, and hernia repair (Perkins and Kehlet, 2000), and it was presumed to be neuropathic in etiology. Chronic pain may wax and wane in certain disease states, or worsen over time, as in cancer and degenerative diseases such as renal failure, diabetes, or osteoarthritis.

2. *Somatic Pain*

When an injured body part is involved in covering or support of the body, such as skin, bone, tendon, joint, or muscle, pain can be sharp and easily localizable. Somatic pain can be acute or chronic. The causes of somatic pain include incision, crush, inflammation, bone fracture, ischemia, or thermal or chemical injury. Postsurgical pain is not the only etiology of concern in research, although it is likely to receive more attention and treatment than other acute or chronic somatic pain states.

3. *Visceral Pain*

Visceral pain arises when visceral organs become inflamed, distended, or ischemic. Because of the type and density of receptors, cutting, clamping, and sharp incision are not perceived as painful, but ischemia, inflammation, and distention are painful and the pain can be unrelenting and extreme. Although the parenchyma of certain organs (lung, brain, and liver) is not innervated, the surrounding tissues (bronchial smooth muscle, meninges, and capsule) characteristically produce the pain associated with such syndromes as encephalitis headache and renal colic. Visceral pain (and deep somatic pain) can “refer” to topical areas of the body of the same dermatome. Thus,

for example, pain of sometimes severe magnitude caused by myocardial ischemia can be felt in the chest wall or arm, and of cholelithiasis to the caudal chest wall and upper abdomen.

4. *Neuropathic Pain*

Neuropathic pain is a particularly problematic type of acute or chronic pain, which occurs as a result of damage to elements of the nervous system, including peripheral nerve, spinal cord, and brain; crush, inflammation, ligation, and ischemia are some potential causes. The underlying mechanism of neuropathic pain is abnormal activity within a peripheral nerve and/or in the central nervous system (CNS). This abnormal activity is triggered by normal nociceptive input related to the initial acute insult but, due to functional changes within the nervous system, it becomes self-sustaining. As a result, the pain can continue even after the inciting cause resolves.

Humans often characterize the pain associated with neuropathic pain syndromes as burning or aching with sudden electric shock-like (“lancinating”) pains. A number of different clinical neuropathic pain syndromes are recognized to occur in humans. Examples of these include post herpetic neuralgia, diabetic neuropathy, central stroke pain, and phantom limb pain. In addition, neuropathic pain is increasingly recognized as a potential component of many disease states (Dworkin et al., 2003). Although animal models of neuropathic pain exist, not much is known or understood about its clinical incidence in animals. It is well known that animals engage in abnormal behaviors (e.g., self-mutilation) following nerve injury; therefore, we must assume that animals are subject to *dysesthesias* (unpleasant abnormal sensations), and potentially significant pain in association with nerve damage. Neuropathic pain may not respond well to analgesic therapy that typically is effective for nonneuropathic pain, and thus the differentiation may be important in the planning of experiments (Campbell, 2001; Kehlet et al., 2006; Perkins and Kehlet, 2000).

B. *Severity of Pain*

Armed with an understanding of how tissue injury leads to pain, we can go about the process of predicting the severity of expected pain. There is unfortunately little experimental evidence to distinguish the levels of pain expected from procedures in many animal species, other than those studies examining dose–response relationships for analgesics. In many cases, it will be possible to refer to expert opinions concerning the painfulness of procedures and conditions found in the veterinary clinical and laboratory animal literature. Table 8-1 lists a compilation of these, as well as symptoms associated with pain. Several veterinary pain textbooks list procedures or diseases that are likely to cause pain in animals, but information on severity may have to be extrapolated from well-characterized species

TABLE 8-1
ESTIMATED SEVERITY OF PAIN BASED ON TYPE AND LOCATION OF INJURY

Tissue or site	Mild	Moderate	Severe	
Skin/integument	Puncture, hematoma, venipuncture or cannulation, subcutaneous fluids or injections, small incision, and restraint by “scruffing”	Larger uncomplicated incision, abscess, skin grafts, autoimmune dermatitis, rewarming hypothermic skin, ionizing radiation damage, and chemical irritation	Extensive burns, degloving, crush or bite wounds, major soft tissue excision, and mastitis	Rubbing, guarding,
Muscle/tendon	Minor bruise, intramuscular (IM) injection, lactate accumulation (after exercise), and restraint by squeeze board or hurdle	Muscle or tendon tear or incision, viral or postvaccination syndrome (cytokine mediated)	Generalized myositis, fasciitis, and extensive excision	Reluctance stif
Bones/joints	Periosteal bruise and joint tap	Bone or bone marrow biopsy, external fixation of fracture, simple osteotomy, tail amputation, joint surgery, and osteo- or rheumatoid arthritis	Fracture (displaced) and repair (plating), amputation of limb or multiple digits, panosteitis, bone tumors and metastasis, bone or bone marrow harvest, and joint replacement	Reluctance stif disuse
Nervous system/spine		Trauma, thoracolumbar disk disease, craniotomy, neuroma, cerebrospinal tap, laminectomy, and myelography	Meningitis, encephalitis, nerve entrapment or ligation	Licking, (neuropath neck photophobia and
Thorax	Cough, pleurocentesis	Chest tube drain, pleuritis, bronchitis, and pneumonia	Thoracotomy and rib resection	Shallo lie “w muscle
Viscera	Cystocentesis, mild cystitis or gastritis, esophagitis, and gavage	Castration, cystitis, urethral catheterization, enteritis, parturition, and egg laying	Nephrolith, pyelonephritis, hepatitis, visceral torsion or distention, and ischemia (especially myocardial)	Shallo unwilling looking and
Abdomen	Laparoscopic surgical approach ^a and abdominocentesis	Laparotomy (no inflammation), visceral resection (nephrectomy, splenectomy, and ovariectomy), and enterotomy	Peritonitis, necrotizing pancreatitis, cholelithiasis, and laparotomy with inflammation	Unwilling shallo muscles, looking
Eye	Conjunctivitis and eyelid surgery	Corneal injury/ulcer, enucleation, and bright light	Glaucoma, uveitis, and corneal ulcer—inflamed	Rubbing, photophobia
Ear	Ear canal exam and ear punch	Otitis externa, pinna surgery, stereotaxic ear bars, and sound	Ear canal ablation, tympanitis, and otitis media	Rubbing,
Oral cavity	Endotracheal intubation, gingivitis, snaring (pig), and twitch (horse)	Mucositis, tooth removal, and tracheostomy	Abscessed tooth root and mandibulectomy	Sali sw

Note: The amount of pain experienced varies on an individual basis. This is not an exhaustive list of painful conditions or procedures in laboratory animals. Note that signs and may be accompanied by immobility, abnormal posture, inappetance, dullness, anxiety, guarding, aggression, or struggling. Chronic pain may be accompanied by altered. Many signs of pain are species-specific, for example, “prey” species and cats are more prone to become immobile. (Dobromylskyj et al., 2000; Hardie, 2000; Mathews, 2000; Muir and Gaynor, 2002)

^aRetention of insufflation gases may cause greater amount of pain than expected.

TABLE 8-2
SUGGESTED RESOURCES FOR SEVERITY AND ASSESSMENT OF PAIN CAUSED BY PROCEDURES IN ANIMALS

Reference	Species	Comments
Ness, 1999; Carstens and Moberg, 2000	Rodents and other species	Experimental animal models of nociception and humane endpoints. Both issues contain articles that are of use for determining extent and signs of pain, including recognition of pain and distress.
Leenaars and Hendriksen (2005) Martini et al. (2000)	Rodents and rabbits General, not species-specific	Information about signs and assessment in ascites models. Presents severity scheme for classifying procedures as minimal, medium, and high severity based on the amount of pain and disability that would be involved.
Hawkins (2002)	General, not species-specific	Lists approaches for determining potential impact of experimental pain and distress, including use of pilot studies, consultation with other veterinarians and researchers, previously submitted score sheets, and scrutiny of literature on significance of condition in humans.
Baumans et al. (1994)	Rodents and rabbits	FELASA guidelines on pain and distress suggest signs of pain corresponding to three levels of severity.
Mathews (2000)	Dogs and cats	Examples of surgeries and conditions categorized as mild, moderate, and severe, as well as a pain rating system.
http://www.vet.ed.ac.uk/animalpain/	Livestock	Complete online resource for physiology, assessment, and treatment of pain. Video clips and self-assessment especially useful for training purposes.
http://www.ahwla.org.uk/site/Tutorials.html	Multiple species examples	Tutorials emphasizing normal animal appearance and behavior, and recognition of pain in animals. Graphical illustrations and video clips, useful for investigator and care staff training.
AALAS Animal Care and Use Courses Library on anesthesia and analgesia, go to http://www.aalas.org/index.aspx and online resources	Mice and rats	Concepts and procedures for minimizing pain and distress; useful for investigator and care staff training.
OECD (2000). Guidance Document on the Recognition, Assessment, and Use of Clinical Signs as Humane Endpoints for Experimental Animals Used in Safety Evaluation. Paris: OECD	General, not species-specific	Suggests methods to assess severity prior to undertaking study, and methods of assessment of animal condition.
ACLAM (2006)	Rodents and rabbits	Lists typical procedures performed in rodents and rabbits with categorical ranking of expected amount of pain, and general species signs of pain.

(including humans) to other species (Hardie, 2000; Hellyer, 2002; Mathews, 2000).

Hawkins (2002) reports some approaches used by laboratory animal professionals for determining the potential impact of experimental pain and distress; strategies include use of pilot studies, consultation with other veterinarians and researchers, previously submitted score sheets, and scrutiny of literature regarding the significance of related conditions in humans. Other references for severity and assessment of pain are in Table 8-2. Such published guidelines and approaches are particularly useful for investigators and IACUC members who must evaluate the severity of experimental procedures and determine what special precautions or stipulations should be considered prior to approving these procedures. Karas also makes use of reviews of procedure and disease-related pain in the human medical field to guide estimates of pain severity in animals. An example is that of craniotomy surgery. Craniotomy pain in animals has been considered insignificant because “brain parenchyma has no nociceptors.” However, the scalp, cranial

periosteum, and lining are richly innervated with nociceptors, and surgical approach to the brain disrupts these tissues. Craniotomy pain, if present, may have gone unnoted, because headache is difficult to assess in animals. To determine the expected severity or duration of craniotomy pain in animals, it is possible to search for reviews of the topic in the human medical literature. As presented in Table 8-3, using the search terms “craniotomy” and “pain,” and then limiting the results to “reviews,” several general features of pain after craniotomy can be quickly gleaned. Although this does not mean that the procedures definitely cause pain in animals, the IACUC can determine that there may be a potential need to treat and monitor pain.

Differences in the degree of pain that a procedure causes may depend to an extent on the species. For example, humans cannot stand barefoot on ice or moderately hot pavement, but most quadrupeds and birds can do so. Noises outside the range of human hearing are not distressful to humans, but may be so to other species; tolerance to ambient temperatures, gas concentrations, and odors also vary by species. Such differences depend

TABLE 8-3

USE OF A LITERATURE SEARCH ON SEVERITY OF CRANIOTOMY PAIN IN HUMANS TO HELP PREDICT PAIN IN ANIMAL MODELS

Citation	Relevant information	Interpretation
Gottshalk et al. (2007)	Study of incidence and severity of postoperative pain in 187 patients having supratentorial (ST) or infratentorial (Inf) surgical approach. 69 and 48% of patients reported moderate to severe pain on postoperative days 1 and 2, respectively. Inf approach was more painful than ST. Both opioid and nonopioid analgesics were employed.	In a current prospective study of craniotomy pain, moderate to severe pain of at least 2-day duration was experienced in a human cohort, despite the fact that patients were treated for pain. Animals having craniotomy might experience a similar degree of pain, especially if the Inf approach is used.
Rahimi et al. (2006)	Report of a small prospective randomized controlled trial (RCT) of opioids alone versus an opioid/COX2 preferential nonsteroidal anti-inflammatory drug combination to treat craniotomy pain, as some disadvantages to use of opioid-only methods can be cited. The opioid-only group was found to have significantly longer hospital stay and greater levels of pain.	Combination (multimodal) therapy with opioids and NSAIDs may reduce pain safely in craniotomy subjects and reduce incidence of opioid side effects. Single modality analgesia is potentially less effective as a means of pain control.
Bala et al. (2006)	A prospective RCT was conducted of bupivacaine (B) versus saline (S) for local analgesia after skin closure for ST craniotomy. Sixty percent of S-treated patients had moderate to severe pain in the first 12 hours, versus 25% of B-treated. Additional analgesia was needed sooner and more often in S group. Local analgesia with bupivacaine provided up to 4 hours of "pain free" status after ST craniotomy.	Nerve block infiltration with bupivacaine may provide 4 hours of analgesia after certain surgical approaches to the brain. Technique may be valuable part of multimodal analgesic treatment of craniotomy pain.
Gray and Matta (2005)	Describes anatomy of skull and linings with innervation. Review of studies of incidence of postcraniotomy pain as well trials of treatment method. Discussion of pathogenesis of and reported quality of acute pain (nociceptive, tension type, and incisional), some pain physiology. Also reviews reported incidence and pathogenesis of chronic pain following craniotomy (2 months to 2 years, with incidence ranging from 9% to 82%, varying with surgical location).	Craniotomy pain severity depends to some extent on surgical location. Reported incidence and duration in humans, if extrapolated to animals, suggest that pain is possibly underestimated and undertreated. Craniotomy may lead to chronic pain.

on adaptations to ecological niche. Specific situations should be investigated using standard behavioral testing methods such as preference testing prior to making an assumption that a stimulus is not painful for a particular species (Weary et al., 2006). There has been a historical tendency to expect that animals in general feel less pain than a human would, and this tendency is reinforced because animals may not display overt signs of pain. It is critical to dispel the myth that animals are generally less able to feel pain than humans, even if differences in the total experience may exist (ACVA, 1998).

Strictly painful conditions are not the only ones that are capable of being unpleasant or noxious. Adverse states such as fear or anxiety, hunger, dehydration, nausea, boredom, or isolation are important for animal well-being, and these conditions are not ameliorated by analgesics. Although many signs of pain may not be distinguishable from those of other types of noxious experiences, this review is geared toward recognition and prevention of pain. However, two emotional states, fear and anxiety, may increase the amount of pain experienced by the subject. Pain can exacerbate anxiety and vice versa (Linton, 2000; Morley et al., 1999; Perkins and Kehlet, 2000; Ploghaus et al., 2001). In humans, this means that behavioral (cognitive) interventions as well as nonanalgesic drugs that mitigate anxiety may reduce pain (Belzung and Griebel, 2001). Thus, the use

of strategies to reduce anxiety and the recognition that certain strains or individuals are more anxious are important in the overall consideration of whether anxiety will play an important role in the pain experience.

C. Strategies for Minimizing Pain

Prediction of the severity of expected pain is the first step in a strategic approach toward its minimization. Pain either may be brief/self-limiting or prolonged, in acute situations, or may be constant, resolving, or escalating over time in chronic models. Establishing the time frame during which pain is expected to be present is essential for optimal monitoring and therapeutic intervention, but three important measures for prevention of pain are still to be considered. These are as follows: ensuring stable and supportive husbandry conditions; training of investigators in low impact handling and surgery/procedural methods; and preemptive and multimodal analgesia administration.

1. Stable and Supportive Conditions

Reduction of the *affective-motivational* component of pain by reducing or eliminating noxious environmental and

psychological stressors is a desirable adjunct or alternative to drug treatment. By eliminating serious nonpain stressors, one would expect to improve overall well-being. Husbandry staff are usually familiar with generally accepted husbandry practices such as frequency of cage changes, need for specific ambient temperature/humidity/lighting conditions, etc., but research staff may not realize the importance of these factors and should be appropriately advised. Careful attention should be directed to the animals' social environment. While social species of animals may be seriously stressed by isolation, efforts must be made to protect vulnerable animals (e.g., those recovering from surgery) from aggression by cage or pen mates. A stable environment is particularly important. Changes in food, water, temperature, lighting, social groupings, or even position within the room all may be significant stressors and should be avoided when dealing with animals in pain.

Researchers can do much to limit stress associated with experimental procedures; there are two basic approaches: (1) plan studies with the likely responses of the animals in mind and, whenever possible, choose approaches and techniques that are less likely to cause significant pain or stress; and (2) allow time for the animals to acclimate to the research facility and the laboratory, and take the time required to accustom them to handling, restraint devices, and other specialized equipment prior to beginning the experiment (Grandin, 1997; Morgan and Tromborg, 2007).

2. *Reduction of Tissue Injury Due to Surgery or Procedures*

In any case where tissue injury occurs, the extent of damage and inflammatory response will affect the amount of acute and possibly chronic pain that is experienced. This is particularly relevant when considering (1) the type and amount of disruption of innervated structures and (2) the degree of expertise of the surgeon. Current opinion is that reducing the size of the incision lessens the amount of pain felt by the patient. The degree of pain associated with the surgical procedures in Table 8-1 is what would be expected if the procedures were performed by a skillful surgeon practicing good tissue-handling techniques. Unnecessary trauma of tissues, allowing tissues to become dry, and/or generally poor surgical technique will result in increased postoperative pain.

Any type of tissue disruption can potentially cause pain, and procedures that may cause tissue disruption are often not apparent from descriptions listed in animal use protocols. For example, extensive retraction of the ribs following intercostal incision enhances surgical access and may decrease surgical time, but can result in more severe pain. Abnormal positioning during surgery or strong restraint, including surgical table positioner-induced injury, can lead to muscle and nerve damage to the extent that pain and loss of function is possible. Increased inflammation, including that associated with infection, will also cause increased postoperative pain. Thus, unnecessary pain from manipulations can only be avoided if all personnel are

taught to understand the potential significance of all components of animal handling (Martini et al., 2000). Ultimately, reduction of tissue injury due to surgery will be possible by means of new technological advances, such as catheter-based placement of devices, miniaturization, and fiber optic and laser guidance and surgery. These technologies contribute to the emerging field of *minimally invasive surgery*, which is gaining popularity for reduced pain, convalescence, and severity of impact upon the patient compared with open/scalpel surgical techniques (Walsh et al., 1999).

Although not adequately studied in veterinary patients, the literature about teaching/learning of surgical skills by MD trainees appears to support the premise that complication rates and duration of surgery are related to the number of procedures performed and the quality of the training. Weise et al. (2004) found that more experienced surgeons (having performed 10 times the number of surgeries compared to the less experienced group) had a complication rate of 2.2% versus 10.7% for the less experienced group. As might be expected, it was noted that some of the recorded complications were associated with greater initial postoperative pain. Georgeson and Owings (2000) cited the inverse relationship between duration of procedure and number of surgeries performed by MD surgeons. When surgeons have performed fewer than 10 of a particular endoscopic procedure, the duration of that surgery is roughly double that of surgeons who had performed the same surgery 40 times. Expertise reduces procedure duration and improves outcome, and if surgical time increases postoperative pain (presumably due to increased tissue handling), then one might surmise that as surgeons move along the learning curve for a technique, pain from a surgery could be reduced (Kahn et al., 2003).

In smaller patients or animal subjects, incision length is often described as "small," therefore implying that it is less consequential to the patient; instead incision size in tiny animals is in fact either proportional to body size or larger in order to facilitate access to the surgical site by comparatively large fingers and instruments. It can be argued that the pain resulting from a surgical procedure in a laboratory animal model may depend significantly on the degree of pain or invasiveness of a procedure, which may in turn depend on the skill of the surgeon, which is dependent on the quality and quantity of training, as well as on innate characteristics of the surgeon. Fortunately, by assuring that the individuals who perform surgery on animals are well trained in both general surgical techniques and aseptic practices, poor technique can be eliminated as a cause of excessive postoperative pain.

3. *Preemptive Analgesia*

An attractive theory, the original conception of preemptive analgesia was that antinociceptive intervention given prior to a surgical incision would prevent the establishment of central or peripheral sensitization and thus "preempt" pain more

effectively than interventions started after surgery. A number of animal models have convincingly demonstrated an effect of timing on pathological pain, and trials have been designed to evaluate the importance of timing of analgesia (Lascelles et al., 1995, 1997). Over the years, the small-scale clinical trials have been subjected to meta-analyses by numerous authors (Moiniche et al., 2002; Ong et al., 2005; Pogatzki-Zahn and Zahn, 2006; Straube et al., 2005). From such reviews, it can be variably gleaned that there either is or is not evidence for “preemptive” effects of analgesic techniques; there are limitations in study design and methods, including choice of outcome measures, technique/drug, and even definition of what is actually meant by preemptive dosing.

Ong et al. (2005) reviewed studies for evidence favoring the validity of preemptive analgesia using the following measures: (1) reduced postoperative pain scores; (2) decreased supplemental postoperative analgesic requirements; and (3) prolonged time until first rescue analgesia. These authors concluded that “preemptive analgesia showed an overall beneficial effect in selected analgesic regimens that was most pronounced after epidural analgesia, local wound infiltrations, and systemic nonsteroidal anti-inflammatory drug (NSAID) administration.” Moiniche et al. (2002) indicated, however, that the overall conclusion of their meta-analysis was negative, i.e., not supportive of preemptive analgesia as a superior approach. Analyses of specific drug classes have also been attempted, and at least one study found an overall benefit of *N*-methyl-D-aspartic acid (NMDA) channel antagonists (e.g., ketamine and dextromethorphan) given preincisionally; another study found that coxib (cyclo-oxygenase 2 inhibitors) NSAIDs were overall of greater benefit for postsurgical pain when given preemptively (McCartney et al., 2004; Straube et al., 2005).

The emerging thought is that timing of initiation of analgesia per se is not as important as duration and efficacy of analgesic interventions (Dahl and Moiniche, 2004; Kissin, 2005; Pogatzki-Zahn and Zahn, 2006). While the original theories focused on the surgical stimulus and its “coverage” by analgesia, a substantial role is now thought to be played by postinjury events. The barrage of input to the spinal cord and brain continues for some time after incisional closure, as inflammation occurs and the peripheral and central sensitization that ensues serves to “maintain” pain (Carr and Goudas, 1999). Experts have written that the concept of “preemptive” analgesia has evolved and is more correctly thought of as “preventive” or “protective” analgesia (Kissin, 2005; McCartney et al., 2004). The aim of preventive analgesic administration is to reduce central sensitization and thus its impact on pain, by means of “aggressive, perioperative, and analgesic intervention on short- and long-term pain after surgery” (Moiniche et al., 2002). Overall there appears to be no loss of support for the fact that the adequacy and timing of analgesics in the surgical patient are critical to optimal acute pain prevention. As clinical pain researchers continue to define targets for therapy, and animal models of surgical pain are studied, the current theory of

preventive or protective analgesia will undoubtedly be further honed.

4. *Multimodal Analgesia*

There are numerous experimental models in which the administration of two or more analgesics (i.e., targeting different mechanisms) has resulted in a synergy (less pain than would be predicted from a simple additive effect) (Kolesnikov et al., 2000; Matthews and Dickenson, 2002; Price et al., 1996). Benefits of multimodal analgesia include the following: more effective analgesia, possible reduction in the doses of one or more individual drugs (this may reduce the side effects of individual agents), and fewer incidences of “breakthrough pain.” There is little uncertainty of whether the concept of multimodal analgesia is valid for human clinical pain. Clinical trials often show evidence for lower total doses of morphine when another type of analgesic is also given at surgery, and a corresponding reduction in opioid side effects such as constipation. The opioids, NSAIDs, local anesthetics, alpha 2 agonists, ketamine, tramadol, and gabapentin have been shown to have robust synergistic effects when used in certain combinations (Guillou et al., 2003; Koppert et al., 2004; Reuben and Buvanendran, 2007; White et al., 2007). There is an unrecognized potential for use of local anesthetic nerve and “intracavitary” blocks, of ketamine, and of combinations of these techniques with each other and with opioids and NSAIDs when planning for surgical analgesia in animals (Carpenter et al., 2004; Muir et al., 2003; Shafford et al., 2004). Multimodal analgesia may also be effective for treatment of chronic pain that is unresponsive to a single agent, and the use of such “adjuvant analgesics” (antidepressants, antiepileptic drugs, NMDA channel antagonists, intravenous (IV) and transdermal lidocaine) is common now in both human and veterinary medicine (Knotkova and Pappagallo, 2007).

The tenets of current clinical veterinary pain medicine include: (1) use of analgesics such that the drugs are present at effective plasma levels while nociceptive barrage and pain sensation are greatest; (2) potential use of more than one type of analgesic (targeting multiple pain mechanisms, such as local anesthetics and opioids) when expected level of pain would be moderate to severe; (3) ideally, avoidance of peaks and valleys in analgesic dosing to the extent possible, through administration by continuous or overlapping methods, or “superimposition” of a long-duration drug (e.g., NSAID) on top of a shorter-duration drug (buprenorphine); and (4) monitoring of effectiveness and, when doubt arises whether an animal’s clinical signs are due to pain, trial of an additional dose of analgesic to “prove” that pain was at issue. While these guidelines for effective pain management are comparatively easy to apply in clinically familiar species such as dogs and cats, it will require more ingenuity to apply them in other laboratory animal species. Nevertheless, as a large proportion of basic pain science is conducted on rats and mice, it seems logical to expect that rational analgesic therapy for pain is an attainable goal in rodents.

IV. POSTPROCEDURAL CONSIDERATIONS: RECOGNIZING AND MONITORING PAIN

A. When and How Often to Monitor?

The time course of pain varies with the etiology, and so will the frequency and type of assessment. The fact that some analgesics have been given is not adequate to ensure absence of pain without an effective monitoring system. In the early post-operative period, residual sedation from anesthesia may mask pain, and more frequent assessments are needed in the first 24–48 hours after surgery. It is well accepted that waiting for convincing signs of pain leads to more difficulty in amelioration, and of course means that the animal has been in pain for some time prior to dosing. For this reason, “as needed” dosing schemes may be inappropriate in the first 12–24 hours or longer after major surgery. Once a chronic or increasing type of pain is induced, this should automatically trigger greater frequency of observation to detect need for treatment or intervention. When animals are observed to be abnormal in the early morning, this is an indication that an earlier intervention or observation should be instituted. Also it should always be borne in mind that severely disabled or sick animals may not be able to show commonly recognized signs of pain (Hansen, 2005).

Inflammation, if not well controlled, occurs over the first 24 hours after tissue injury; after that time it may subside unless the model dictates that it continue. It has been suggested that, based on clinical experience in humans, gradual reduction of discomfort takes as much as 10–14 days after soft tissue surgeries and 4–6 weeks after orthopedic surgeries (Kehlet and Dahl, 2003). However, as metabolic rate may determine the speed of healing, it might be surmised that smaller species may recover more rapidly from simple surgical procedures. Greater doses or more frequent administration of analgesics are needed when injury is severe, with lower levels needed on subsequent days. Until the contrary is known, observations should continue, albeit at a lower frequency until the animal appears normal to all measures, rather than stopping at the end of the “predicted” duration of analgesia dictated in the protocol. In addition, animals subjected to procedures that cause pain, such as adjuvant injection, may not have obvious signs of injury (abscessation), but may show signs of sickness behavior (lethargy, somnolence, and shivering) and may have generalized pain that will respond to analgesia or other supportive measures.

Pain of insidious onset (cancer, disease, and degenerative) is more challenging to assess. Chronic pain, cancer pain, and terminal pain (pain that occurs at the end of a disease process such as renal insufficiency) are quite different than acute surgical or procedural pain; the onset may be gradual and coping ability may develop to some extent along with progression of the condition, or coping ability may suddenly fail at a critical point. Many pet owners fail to notice symptoms of chronic osteoarthritis pain in dogs and cats, for example, because weight can be shifted

to nonpainful joints, and the animal’s activity gradually slows down over time. In instances where treatment with an effective analgesic restores mood and agility, it can be inferred that pain was substantial prior to treatment, even though the observer did not recognize the significant pain. Laboratory animal models of chronic pain may vary in the time course of intensity depending on whether an acute induction (i.e., urate injection) or progressive worsening (i.e., diabetic neuropathy) is studied. In a study of chronic joint pain induced by adjuvant injection in Lewis rats, Lindner et al. (1999) found that morphine pellet implants at two dose levels did not reduce weight loss or improve overall daily activity compared to untreated rats. However, in a battery of tests that measured ambulatory function, fine motor control, and performance on a food-rewarded bar pressing task, a dose-dependent beneficial effect of morphine was seen. It was noted that the pain induced by the model was greater during the early part of the chronic pain study than later on. In cancer models, as tumors grow and impinge on or obliterate normal structures, pain can worsen. It is thus important to have some idea of the time course of expected pain, to enable a responsive increase in frequency of observations and intervention with additional analgesia, support, or euthanasia.

B. Behavioral Assessment of Pain

Behavioral changes are the major methods that will be used “cage-side” to assess pain. At the outset, it should be acknowledged that any approach must take into account species-specific differences, and that technical staff, investigators, and veterinarians must be clear on what these are. Many criteria may be widely appreciated in one species (a painful dog cries when handled) but will never or seldom be seen in another (chinchilla). If a new or novel species is to be used (e.g., armadillo) then information from the zoo or ethology literature or experts can be consulted to determine husbandry practices, enrichment, and normal behavior. Generalized interspecies considerations can be as varied as the appearances or habitats of the animals, and include the following:

- The differences between socialized versus nonsocialized domestic species and colonies. Certain sources for domestic species may not provide much habituation to human contact, and response to handler is often recommended as one element of an overall health assessment. When animals are not habituated, handling represents an additional stress, and may reduce or alter the behavioral repertoire during observation. Nonsocialized animals may behave more like wild or prey species.
- Wild or dangerous species can usually not be handled with the frequency or ease necessary to weigh or palpate body parts. Like any stressed animal, such species may also be inhibited in behavior in the presence of an observer. However, acclimation and training of animals to engage in

certain rewardable tasks may help distinguish those in need of additional treatment.

- “Prey” species (may include hoofstock, rodents, rabbits, other small mammals, and nonmammals) are thought to fear predation to the extent that they will “attempt to look normal” in all but the most dire circumstances. This teleological explanation appears a suitable theory for why it has taken so long to be able to see abnormal pain behaviors in certain species. However, the breadth of the psychology and reproductive behavior literatures involving prey species, for example, would suggest that pain assessment might only have lacked application of enough creative energy and that this can be remedied.
- Circumstances that do not permit easy monitoring. Animals of virtually any species can present a difficulty when involved in biosafety risk, fragile, or environmentally constrained models. If animal contact must be limited, then remote observation or other novel methods will be required to assess well-being. These are discussed in a later section. Nocturnal or hibernating animals may be able to be viewed in reverse daylight or other altered light conditions so that a true estimate of activity is obtained. Rabbits in standard stainless steel caging are difficult to observe without opening the door, and small rodents may be difficult to observe without removing the cage lid.
- Interindividual variations, especially in larger animal species, will make it reasonable for caretakers to learn a given animal’s prestudy demeanor, and for this to factor into subsequent analyses. For example, an anxious dog may be expected to require more sedation or to have stormy anesthesia recoveries, and may require more analgesia after surgery. Another example of this is that of a previously dominant sow who allowed another animal access to favorite treats offered by a caretaker after surgery, a role reversal that was “put right” after more analgesia (Paul Flecknell, personal communication). Strain or breed differences may also make it difficult to apply criteria across a species (Baumans et al., 1994).

1. *The Importance of Observer Training in Species- and Procedure-Specific Methods of Assessment*

On some level, human observers naturally apply some blend of the paradigms discussed below to animals, saying for example, the animal is eating/walking normally or not, is or is not writhing/vocalizing/sleeping, etc., indicating that if the pain were significant, the normal or pain-specific behaviors would not be seen. Sensitive, motivated, caring individuals may fail to recognize pain in animals nonetheless. It is difficult to appreciate changes in animal behavior, and the ability to do so depends heavily on familiarity with the species and the conditions under which observations occur (i.e., the amount of time spent observing and the time of the day). Therefore, if a system is used that leaves too much to the observer’s personal notions of how pain

ought to look, it will not be detected, or symptoms of other conditions (such as dehydration or dyspnea) might be interpreted as pain, with untoward consequences. Although the veterinary literature indicates that factors such as gender, age, level of training, and context (food animal production versus companion animal settings) appear to highlight major disparities in attitudes toward animal pain in general, a structured examination of how this impacts the ability to detect animal pain is not available. It is evident from the fields of human pain medicine that a significant barrier to accurate assessment of pain is when it is done by proxy (i.e. evaluated by someone, or some indication other than direct patient report) (Nekolaichuk et al., 1999; van Dijk et al., 2002). And since pain must be identified to be adequately treated, if the severity is underestimated it is not likely to be treated aggressively enough. Therefore, continual training and mentoring of observers will be necessary, given the diversity of types of pain and conditions, which laboratory animals might experience.

The laboratory animal veterinarian or researcher is often faced with the need to assess well-being in animal species (or entire orders) of limited familiarity, such as fish, marsupials, mustelids, reptiles, and amphibians, and in neonatal animals of familiar species. Sources such as zoo and wildlife veterinarians or biologists and an extensive neonatal human pain biology literature might prove useful in these cases where little is known.

2. *Behavioral Assessment Approaches*

With consideration of the caveats of an animal’s species, strain, breed, and previous experience, and allowing for study limitations in making observations, there are essentially four behavioral observation approaches that may be used to assess whether an animal’s pain is easily tolerable or not. These involve observations of normal behaviors, abnormal behaviors, evoked pain behaviors, and changes in behavior in response to analgesia.

a. Examination of the impact of pain on normal behavior

The intensity or impact of pain or illness may be directly related to changes in “normal” 24-hour activity levels (Negus et al., 2006). Activities such as feeding and food-rewarded behaviors, exploration, wheel running, nest building, social interaction, and sleep may be negatively influenced by the presence of pain (Crawley, 1999). Observations of activity must be tempered by an understanding of factors such as species-specific behavior, pain chronicity, periodicity, drug treatment, and willingness to demonstrate altered behaviors in the presence of an observer. A normal or abnormal behavior must occur with enough frequency that it can be seen during a relatively short observation period (Hansen, 2005). Lack of normal behavior patterns might, however, be inferred by looking at the results of such behaviors (fur or feather condition, nail wear, quality of

nests built in mice, chewing of wooden objects in rats, or failure to consume favored food treats). Such “indirect” or “proxy” evidence of normal behavior can potentially be exploited to a greater extent for species that are difficult to observe. Not all animals will be able to exhibit “normal” behavioral repertoire, and this should be recognized. Some experimental constraints may put animals in enclosures or housing where they have no access to bedding, toys, or other animals, and critically ill or chronically debilitated animals may not be able to walk or react as healthier animals do, and so development of other methods of assessment is essential (Hansen, 2003).

Feeding behavior and body weight loss/gain (a surrogate measure of oral intake) have been used in multiple rat models of postoperative pain assessment (Cooper et al., 2005; Flecknell et al., 1999; Harkin et al., 2003; Hayes and Flecknell, 1999; Jablonski et al., 2001; Krugner-Higby et al., 2003; Martin et al., 2005; Page et al., 2001; Shavit et al., 2005; Stewart and Martin, 2003). Less commonly reported, studies of pain in mice also often indicate reductions in spontaneous activity, body weight, and oral intake (Dorsch et al., 2004; Goecke et al., 2005; Hayes et al., 2000; Karas et al., 2001; vanLoo et al., 1997). Studies have demonstrated that rabbits consumed significantly less pelleted food and treats immediately after telemeter implantation surgery (Karas et al., 2007), and there are reports that reductions in food intake in rabbits and rodents can be evident from body weight measurement even when animals are fed *ad lib* (Dobromylskyj et al., 2000). Reports of studies of acute procedural pain in livestock species (cattle, sheep, and pigs) do not routinely include feed consumption data. In one study of tail docking pain in calves and heifers, Schreiner and Ruegg (2002) found little effect of pain on feeding, but in a thoracotomy model in pigs, food intake was suppressed postoperatively (Harvey-Clark et al., 2000). Certainly, chronic pain is generally thought to affect weight gain or productivity in livestock. Differences in food intake in the context of acute pain depend on the magnitude of the pain, but also on the body part affected. Inability to access food (e.g., in an overhead hopper because of abdominal muscle or spinal pain) or toprehend food (e.g., oral/gastric pain and masticatory impairment) will almost certainly lead to lower body weight gain. However, an animal showing inappetence in a situation where physical impairment should not reduce food consumption (e.g., food placed nearby on cage floor in a stifle surgery model), for example, may be experiencing such significant pain that it will not eat, or may have some other serious problem (sepsis, ileus, and renal failure). In some cases, using body weight as an indicator is not feasible (large pigs and primates), and consumption of food or treats is a better option. In any case, body weight alterations should be considered nonspecific indicators of pain, and only used in conjunction with a comprehensive assessment program.

Grooming activity is another often cited nonspecific indicator of well-being, and decreased grooming or preening leads to abnormal fur or feather maintenance. Piloerection and soiled coat are indicators of generalized illness in rodents and other

mammalian species, and ruffled feathers are indicators of poor well-being in birds (Dobromylskyj et al., 2000). Lack of preening and dust bathing were observed in chronically lame turkeys (Duncan et al., 1991). Thus, altered appearance may identify undertreated individuals, or those approaching a state where alleviation of pain or distress is not possible. While grooming is a general feature of normal behavior, in certain cases excessive grooming may be associated with pain (see below).

Social behavior is another aspect of behavior that can be used to assess well-being. Interaction with cage or pen mates is commonly decreased in pain and illness. Social isolation and lack of play and sexual activity may be evident (Baumans et al., 1994; Hay et al., 2003). In a study of owner-reported pain in dogs, decreases in curiosity, sociability, marking, and playfulness corresponded with chronic pain conditions (Wiseman-Orr et al., 2001, 2006). Mental dullness may be seen, and response to handling or approach of an observer is often altered; in cases of severe pain, some animals appear unable to respond or unaware of the presence of a human. Conversely, dogs who were observed to be dull and depressed responded to the entry of a human by tail wags and greeting (which was, however, subtly diminished from normal quality) (Hansen, 2003). This phenomenon may erroneously lead to the conclusion that such animals are not in significant pain when, in fact, additional analgesia reverses their dullness when alone and improves vigor of greeting and interactions with humans. Wiseman-Orr et al. (2001) also found that dogs with chronic pain were reported to have increases in aggression and compulsive behavior.

Locomotion or distance traveled is also frequently decreased in painful states. Duncan et al. (1991) found that among turkeys with osteoarthritis, analgesic-treated birds took more steps and spent significantly more time standing than untreated birds. Rabbits remotely observed in pen-exercise periods after laparotomy traveled significantly less distance than prior to surgery (Karas et al., 2007). Using video-recorded behavior, Hansen (2003) found that total distance traveled and average speed were decreased after laparotomy in dogs housed in runs. Decreases in activity level are also commonly noted in rodent models of acute pain (Liles and Flecknell, 1994). Increases in certain activities may, on the other hand, occur in response to pain. Restlessness is frequently observed in food animals after routine surgical procedures. Two hours after tail banding for docking, calves reportedly spent less time lying down, and stood and walked more. This was in contrast to behavior seen in older cows, who did not exhibit marked changes in behavior (Eicher and Dailey, 2002). Thus, although immobility and increases in “sleep” behavior are general signs of illness or pain in animals and are very likely to be seen in the case of severe pain, increased locomotory movement should not be taken as a sign of lack of pain in every situation (Baumans et al., 1994; Hayes et al., 2000; Morton and Griffiths, 1985; Wiseman-Orr et al., 2001).

Generally, willingness to engage in normal postures or activities can be used as indicators of comfort. For example, members

of some species engage in a vigorous “whole body shake” or stretch upon rising from sleep or rest. In the authors’ experience, an injured dog or horse will terminate the shake at the level of the injury (i.e., stop at diaphragm if abdominal pain is present) or fail to shake at all (head/neck or severe debilitating pain), and when this behavior is seen to be restored to normal, it indicates comfort. Play behavior is a normal activity in young animals (e.g., rabbits, lambs, piglets, and puppies), and its observation could be used as a positive indicator of well-being.

- b. Observations of the incidence of spontaneous episodes of pain-specific behaviors, such as writhing, licking, paw shaking, and limping

Hansen (2003) characterized new onset behaviors in painful animals as occurring for a variety of reasons, that is, as protection against exacerbation of pain (guarding or escape), as expressions of pain that are designed to distract or call attention, as learned responses, or as a result of physical impairment. Although it is possible that an animal might limp because of nonpainful limb dysfunction, administration of an effective analgesic would be expected to help distinguish the cause by improving the lameness in the case of pain.

Grooming and other behaviors directed at the painful body part, such as looking, biting or chewing, kicking, rubbing, and paw or head shaking, may be observed as new onset indicators of pain (Kent et al., 1998; Mellor et al., 1991). Paw shaking and licking are two common measures used in analgesiometric studies of rodents. In rat models of visceral (bladder) pain, increases in both facial grooming and perineal licking were used as indicators of pain (Abelli et al., 1989; Ness, 1999). Roughan et al. (2004) found that rats with experimentally induced bladder tumors groomed the ventral abdomen after handling for dosing and examination, and that this activity was not seen in subjects treated with analgesics. Excessive grooming, including autotomy of affected body parts, can be a feature of neuropathic pain conditions. Birds and mammals may excessively groom a painful body part in both acute and chronic pain states. However, such behaviors may occur too infrequently to be observed or not at all in the presence of humans, especially in nocturnal animals. Molony and Kent (1997) described “active” behaviors of lambs after castration or tail docking such as kicking, stamping, rolling, jumping, tail wagging, licking, or biting at the site.

Abnormal postures frequently occur in painful animals, and may include writhing, hunching, inability to lie down, inability to roll into sternal recumbency, stiffness, walking on toes, and inability to hold tail up (Muir and Gaynor, 2002). Such postures depend on the affected body part. Abdominal and thoracic surgery often causes an increase in tone of the abdominal muscles (“splinting”) and breath-holding or shallow respiration. Pain of abdominal visceral organs may be accompanied by writhing. In rats, acute pain after ovariectomy was accompanied by a hump-backed position, contraction of abdominal muscles, stretching, and squashing the lower abdomen

against the floor (Gonzalez et al., 2000). Roughan and Flecknell (2001, 2003) analyzed rat behaviors after laparotomy and three behaviors specific to pain could be observed in the immediate postoperative period: twitching of the back and flank, stagger/fall, and back arching and abdominal writhing.

Spontaneous vocalization is often assumed to be a universal pain symptom; however, whether animals vocalize or not may be a species-specific and even an individual characteristic. Vocalization in dogs after surgery is less specifically indicative of pain and more commonly a sign of anxiety; it is not a feature of pain in cats unless pain is extreme (Gassel et al., 2005). Vocalization in ruminants is uncommonly reported as occurring as a result of acute pain, but is a well-known behavior when an animal is separated from the flock. Lay et al. (1992) compared responses to freeze versus heat branding (versus sham) in dairy cattle, and found that peak heart rate, cortisol levels, and aversive behavior were all higher in branded animals compared to sham. Taken together, these results are interpreted as indicating that the experience was painful; however, the animals did not vocalize. The vocalization may be undetectable, either as distinguished from background calls and cries (pigs and goats), or because calls may be outside the range of human hearing. Weary et al. (1998) used a sophisticated method of analyzing call frequency in piglets, and concluded that in castrated animals, the rate of high-frequency calls was higher than in sham-restrained piglets, but this difference would have been undetectable to human ears. In addition, these investigators found that hearing calls of other piglets being castrated increased the call frequency of piglets subsequently castrated, and they concluded that distress may have increased the noxiousness of the experience. Most rat vocalizations are outside the range of human acoustic detection, and therefore if calls do occur in response to pain, they will not be heard during normal observation methods.

- c. Evoked behavioral responses

Pain in relation to movement can also be used as a clinical indicator of pain. In human clinical studies, pain scores are often found to be similar in treatment versus control groups when pain is assessed at rest, but when *dynamic pain* is studied (subjects might be asked to do a task such as sit up or cough) differences between groups in mean pain score become evident. This indicates that inactivity is protective of pain, and that normal postures may not be able to be sustained in more painful subjects. For this reason, most currently accepted veterinary pain scoring systems include an interactive component of assessment, for example, the animal is asked to walk or a wound is palpated. This practice mimics the technique of asking humans to bend or cough, and is thought to be of significant value in detecting moderate-to-severe pain in animals whose behavior may appear normal at rest. Pain of the abdomen, spine, and thoracic wall regions may cause unwillingness to bend laterally; thus, quadrupeds will be seen to take additional steps when turning. The degree of lameness exhibited is a dynamic (and arguably

evoked) behavior that is used to assess orthopedic pain. Several rodent models have been published using gait evaluation scores for assessment of the degree of bone cancer pain (El Mouedden and Meert, 2007).

Because not all laboratory animals are amenable to being led or to having their wounds palpated, dedicated observers can devise novel methods to assess pain evoked by activity. Changes in operant responding frequency have been used to investigate analgesic drug efficacy and are built on the premise that pain decreases how much the animal will work to gain access to food (Martin et al., 2005). Although animals are typically fasted in order to increase their willingness to work for food reward, this approach could be adapted for monitoring ability to stand and stretch, for example, by placing valued food treats above the animal (in a hopper) or so that a door or gate has to be pushed to gain access. For support of debilitated animals, food, and sometimes high-moisture or enhanced nutritional content matter, is placed in an easily accessed location (i.e., cage floor) so that an animal has to expend less effort to reach it. It would not be acceptable to withhold food altogether from recovering or sick animals so that they would have to work to earn food as a reward. Roughan et al. (2004) reasoned that regular handling for exam or treatment in rats with advanced cancer may have intensified licking behavior as a sign of pain in untreated versus analgesic-treated animals in the period after handling. However, in that chronic pain model, they did not observe the behaviors (e.g., writhing and back arching) typically seen after surgery to the same body part (bladder). This highlights the fact that assumptions about pain-related behavior may not cross over from one type of pain to another (e.g., acute surgical pain symptoms may not be identical to those seen in cancer), just as they may not cross between species. In other words, any new onset behaviors that are expressed may depend on the severity and type of pain (e.g., visceral versus somatic, chronic versus acute, and neuropathic versus inflammatory), as well as species.

d. Behavioral changes in response to analgesic administration

Observing return of normal behavior, or cessation of abnormal behavior in response to analgesic administration (or over time if spontaneous recovery occurs), is a convincing gauge that pain was indeed present when it is observed. However, some analgesics will confound such observations, as many drugs used for treatment of acute and chronic pain may have behavioral effects. Activity level may be suppressed in the early postanesthetic recovery period, especially if longer-lasting preanesthetic and anesthetic injectable drugs are used. Opioids may cause increased activity in certain species or strains of animals (e.g., mice, rats, and horses) and sedation in others (e.g., dogs). The effect of opioids on behavior may depend on the dose or the severity of pain; in other words, locomotion may be more evident in a dog treated with morphine (because it does not hurt to move) than in a dog in significant pain despite the sedative

effects of morphine. In almost every well-controlled study of pain, the measure of effect distinguishes between animals that are effectively treated and those that are not. When no difference is seen between groups, it may be reasonable to conclude that the analgesic was not effective (and this may be due to use of an incorrect dose or type of drug), but it is also possible that behavioral side effects masked the actual improvement in comfort that the animal experienced, or it might be that the severity of the untreated pain was not sufficient to distinguish between treatments. Liles and Flecknell (1994) found that rats treated with either carprofen or buprenorphine had greater intakes of food and water than saline treated. Mice treated with buprenorphine at various doses (0.05–0.2 mg/kg) prior to laparotomy are more active after surgery and their posture is altered, whereas untreated mice fail to move at all after surgery (Karas, unpublished data). In a controlled study of bone cancer pain in mice, performance on a rotarod was improved by administration of morphine, fentanyl, or tramadol, and no evidence of sedation was seen at the tested doses; in fact, some hyperactivity was noted (El Mouedden and Meert, 2007). In addition, experimental analgesia studies in rodents found that doses of opioids that controlled inflammatory pain (from Freund's adjuvant injection) were insufficient when used to treat advanced bone tumor pain. When greatly increased doses were used in the animals with bone tumors, reduction in lameness and dysfunction occurred without sedation (Luger et al., 2002). Thus, the observer's preconceived opinions about sedative or other effects of analgesics may need to be tempered by the realization that side effects may be a necessary component of effective pain relief, but also that when pain is severe, side effects may be less prevalent. Also the tendency to anthropomorphize the common human concerns about alertness that stem from not being able to read or drive should be avoided; weighing the consequences of sedation against those of unrelieved pain should take into account the experience of the fear and stress and the value of comfort to the animal.

3. Pain Scoring Systems

Use of behavior as a method of assessment of pain requires a structured, reliable, valid, and recorded system of evaluation. If a well-constructed and well-applied system is to be used, it can serve as a training method for new observers, to help guide treatment for individual animals, and as a basis for prediction of pain in future studies. The veterinarian can use the results of monitoring from previous work to advise the IACUC on protocols submitted for approval. The first such system specifically designed for use with laboratory animals was proposed by Morton and Griffiths (1985). These authors suggested assessing five variables in each animal: body weight, appearance, clinical signs, unprovoked behavior, and responses to stimulation. Based on specified deviations from normal, each variable is assigned a score of 0 (normal) to 3 (severely abnormal). Many such systems have been modeled on that seminal

report. However, the construction of pain rating systems that are truly valid for nonverbal beings is complex and still not completely understood, and a pain rating system that does not do what it is supposed to do is likely to be worthless—a waste of time and money for the scientists and unhelpful to the animals themselves. The practical application of scoring systems presents several problems, not the least of which is the time and effort that would be required to evaluate a rack full or roomful of group-housed animals.

A complete review of the features and problems of effective pain rating systems is beyond the scope of this chapter, but numerous articles on the subject are available (Cambridge et al., 2000; Hølen et al., 2006; Holton et al., 1998, 2001; Hudson et al., 2004; Morton et al., 2005; Wiseman-Orr et al., 2006). Pain rating tools or scales should be designed with at least three requirements: (1) interobserver variability and observer bias is minimized; (2) they can distinguish varying levels of pain intensity in a particular species and situation; and (3) the degree of “importance” of pain to the subject is detected.

Several terms that refer to qualities of a pain-rating tool include the following: *validity* (the ability of the scale to effectively measure what it is supposed to measure), *responsiveness* (whether the tool can detect a change in pain, particularly one that is meaningful to the subject), and *reliability* (whether two observers will give similar ratings using the tool). Pain scales would ideally be developed to correlate with a “gold standard” of measurement of pain, but since the gold standard in verbal humans is self-report, and animals cannot self-report, this is less likely to be possible (Wiseman-Orr et al., 2006). Relatively few pain scales have been validated in veterinary medicine, but a number of different ones have been reported, particularly for dogs, and countless more are undoubtedly in use (Conzemius et al., 1997; Firth and Haldane, 1999; Holton et al., 1998, 2001; Morton et al., 2005). A pain scale should also ideally be *multidimensional*, in that several aspects of the pain intensity or pain-related disability are rated. Pain is felt to have multiple dimensions, and in human chronic pain rating tools, subjects may be asked a number of different questions about their pain—to rate the intensity, to describe how much it interferes with work or with family relationships, and to indicate how unpleasant the pain is. The importance, or degree of unpleasantness, of pain or of any symptom may be related to the impact on survival that a given symptom has. McMillan (2003) argues that as the unpleasantness of a sensation (not restricted to pain alone) increases, there is an increase in the need for the animal to focus on that sensation, and that it is not the intensity per se but the unpleasantness that may cause distress.

Several types of pain scales are used. *Visual analog scales* (VAS) involve a line with no markings and a 0 (no pain) and a 100 (worst pain imaginable) at either end. Raters (in nonverbal beings always an observer) are asked to place a mark at the point where they feel the pain is. *Numeric rating scales* (NRS) involve a number line with discrete numerical markings (as in 1–10), which are chosen as a score. *Simple descriptive scales* (SDS)

use numerical values assigned to descriptions that categorize different levels of pain intensity (such as mild pain, moderate pain, and severe pain). Once verbal descriptions of behavior become part of pain scales, then care must be taken to ensure that all potential users of the scale assign equal meaning and importance to the words or terms in the description. Arbitrary word meanings can increase the subjectivity of the measurement (Hansen, 2003; Holton et al., 2001). This is particularly problematic with observers using scales not constructed in their own primary language. With both VAS and NRS, the observer’s skill of evaluation is crucial to accurate assessment. Although an observation is recorded rapidly, VAS, NRS, and SDS are considered to have poor reliability when multiple, less skilled observers are using them; advantages and disadvantages are commonly discussed (Holton et al., 2001; Morton et al., 2005). Many observers will never have seen an animal experiencing the “worst possible pain,” and so the VAS scale is subject to bias. In addition, the values that are generated from these scales are nonnumerical; thus, it cannot necessarily be assumed that a subject whose pain was rated at 8 was twice as painful as one whose pain was rated at 4.

A major limitation of analgesiometric testing is that it does not measure the *importance* of pain to the animal. A pain scale that would take into account the various dimensions of pain would be theoretically more useful in indicating how much the pain “meant” to the animal, but VAS, NRS, and SDS scales are said to be unidimensional. An alternative type of scale is the *composite measurement scale* (CMS), constructed such that it takes into account such dimensions as the temporal patterns, location, interference with basic function, or enjoyment of life. These have been widely developed for human patients. There is a paucity of validated CMS pain scales in veterinary medicine, but this does not mean that scales should not be crafted, using a basic but essential understanding of pain rating tools and animal behavior, and combining those with actual “in the trenches” experience with observations. Such scales would ideally “ask” the subject to evaluate how much their pain meant by observing their willingness to do context-specific things, for example, to play (kitten or puppy), to build a nest or run in a wheel (rodent), to stretch or climb to reach a treat. In theory, the CMS approach of looking at several indicators of well-being (e.g., posture, body weight or food intake, motor impairment, evoked pain responses, and social interaction) might also hedge against the problem of a single measure being confounded by unexpected factors. The most difficult aspect of new untested scoring systems is the determination of the point at which an intervention would be made, for example, when the veterinarian would be alerted, additional analgesics administered, or the animal euthanized. This most probably would have to be done in consultation with a veterinarian, who would independently determine when to intervene (without knowing the score). Humane endpoint criteria may have to be developed by watching a number of animals for clinical signs and waiting to see which signs predict death.

C. Other Indicators of Pain

Experimental methods for the quantification of pain include analgesiometry, measurement of physiologic parameters such as hypothalamic–pituitary–adrenal (HPA) axis activation, and alterations in physiologic parameters such as heart rate or blood pressure. In basic pain research, the outcome measure (e.g., serum cortisol and avoidance behavior or heart rate) is sampled after a painful or nonpainful sensory stimulus is given by the investigator (Smith et al., 1996). The same outcome measures may also be sampled in an animal experiencing a more complex pain state, such as postsurgery. More recently, highly technically sophisticated methods have emerged, including measurement of messenger RNA (mRNA) production and other molecular changes that occur at a cellular level, and imaging [functional magnetic resonance imaging (MRI) and positron emission tomography (PET) scan] during pain transmission, transduction, and perception (Negus et al., 2006; Pace et al., 2006). A brief discussion of analgesiometric or biochemical pain measurement methods is included here, because a diligent search of the basic and applied pain literature may offer some clues, not for clinical assessment purposes, but to effective dose ranges for analgesics. For the most part, these experimental techniques are not suitable for *monitoring* of acute and chronic pain of animals on study. This is because despite the reputed advantages of being more objective, those techniques require control groups, specialized technology, histopathological sampling (often postmortem), and time to analyze data for interpretation. For assessing the animal's state in time to provide additional analgesia, the emphasis continues to be on observation of its behavior.

1. Analgesiometry

Generally, for the study of pain, a stimulus of a given magnitude is applied (heat, pressure, touch, current, and irritant substance), either in a normal uninjured subject or in an injured state (such as chronic constriction of a nerve trunk or after surgery), and the subject's response (verbal rating if human subject, movement away from or other behaviors indicative of escape, or reaction to pain) is measured. This “quantitative sensory testing” approach to assessing the magnitude of pain is often thought of a “gold standard” because of its controlled nature.

An inherent feature of analgesiometric testing is that pain in an injured region, and in surrounding regions, can be inferred when a mechanical or thermal stimulus is applied and the animal reacts. The stimulus can be innocuous, as in a light filament or brushing with a cotton swab, or above the baseline nociceptive threshold. A basic understanding of this type of pain testing and its underlying physiology is helpful as it forms the basis for using observations of evoked behavior to clinically assess pain. Also strategies to minimize pain can take into account the generalized decrease in pain thresholds that may occur—if injury to

one body part can decrease pain thresholds elsewhere, then provision of support such as softer bedding might help animals with abdominal or orthopedic pain. Approaches to experimental pain testing in mice are discussed in more detail in the Chapter 23.

2. Physiologic Parameters and Pain

All stressful stimuli can be associated with changes in autonomic nervous system activity and respiration. Increases in heart and respiratory rates and blood pressure often accompany acute and chronic pain states but measurement of such parameters usually involves contact with the animal, and the contact itself may be a stressor that confounds interpretation. Holton et al. (1998) prospectively examined heart and respiratory rates and pupil dilation in dogs concomitantly scored by veterinarians for pain and, although a small correlation between heart rate and pain score was seen, respiratory rate did not vary in a predictable way with pain score. The authors concluded that none of the physiologic parameters they studied would be useful indicators of pain in dogs. In a recently published retrospective of human patients with painful injuries in an emergency room setting, no correlation between patient's self-reported level of pain and heart rate, arterial blood pressure, or respiratory rate were found. Heart rate variability (HRV) is often used as a measurement of pain or stress, particularly in human infant models of pain (Gang and Malik, 2002; Oberlander and Saul, 2002; Storella et al., 1999). Believed to be an indicator of the predominance of vagal over sympathetic tone, HRV decreases in situations of stress and pain and cardiovascular and other disease; normal fluctuations in balance of parasympathetic and autonomic tone become “pinned” toward predominantly sympathetic. In a study of horses with laminitis, Rietmann et al. (2004) found that HRV may be a useful indicator of pain and its alleviation, but emphasizes the need for concurrent behavior observations and a controlled environment. Heart rate, respiration, and HRV can be influenced by multiple factors, including temperature, oxygenation, and blood pressure, and as such may be a potentially useful tools for study of pain and for assessing adequacy of general anesthesia, but not for cageside assessment in the awake animal. The actual direction in which physiologic parameters vary in response to pain is not absolute, because bradycardia and breath holding can occur in response to sudden stimulation, particularly in certain species. Additionally, heart rate and blood pressure changes may be influenced by the presence of anesthetic and analgesic drugs. Thus, in view of the challenges of collecting physiologic data without influencing it, and its nonspecificity, many pain specialists have resorted to pain scoring systems that use behavioral elements only (Holton et al., 1998).

3. Quantitative Biochemical Evaluation of Pain

Searching for objective measures of pain in humans and animals led researchers to consider elements of the HPA axis as

potential candidates. Indeed, much work on acute and chronic pain assessment in animals is based on measurement of HPA axis hormones (Smith et al., 1999). When experiments are carefully controlled, serum or urinary cortisol or corticosterone, or ACTH levels, may assist with discrimination between the effects of different surgical techniques or analgesic methods. However, HPA axis hormones are nonspecific indicators of stress, of which pain is only one type, and levels rise rapidly when animals are handled such that sampling itself can lead to an increase in cortisol. In addition, measurement of serum markers requires sample handling and assay time. Thus, HPA axis hormone production, though perhaps a valuable adjunct to studies of pain and stress intervention, would not be considered useful in the day-to-day clinical assessment of pain in animals. Similarly, new gene expressions (c-fos) in spinal cord and brain have been used as markers of pain—but also rise in response to stress—and require tissue sampling as well as time to assay.

To summarize, despite the fact that these so-called objective methods of pain assessment can give precise information regarding stimulus intensity and dose–response relationships, in day-to-day animal care, neither analgesiometry, nor HPA axis hormone production, nor physiologic parameters appear to be easily evaluated, time responsive, or specific indicators of pain.

D. Novel Methods of Monitoring Pain

To enhance the ability to detect pain in a timely manner, surrogate or remote monitoring methods may be implemented. Such methods are especially useful in cases where circumstances prohibit easy monitoring (biosafety, overnight when care staff are not available), or where animals may not display normal behaviors in the presence of humans. Remote video monitoring can be achieved even in dark animal rooms by use of standard surveillance equipment (using video cameras that have the ability to film in 0 lux conditions or with the aid of infrared light sources), and video can be sent over secure internet, wirelessly, or via hard wiring. Telemetry systems may be useful gauges of activity. Implantable telemeters involve anesthesia and postsurgical pain, and are costly. Noninvasive telemetry systems are being developed for larger species, but still remain expensive (Grossman, 2004; Wilhelm et al., 2003).

Although not automated, other methods of assessing pain, such as training of animals to display a behavior in exchange for a treat, may enable visualization of abnormalities (Thut et al., 2007). Giraudel et al. (2005) trained cats in an experimental joint pain study to engage in certain behaviors (creeping, descending, and climbing) in order to be able to assess degree of mobility/agility, and many primate biologists are using operant techniques to allow examination or procedures. In the future, novel methods of “asking” animals to do tasks, such as to push a weighted cover to retrieve food rewards, may find their way into the laboratory, but these will be useful only if they require

short training latencies and are introduced only after appropriate studies to validate their meaning.

V. Summary

Persons involved in scientific research and research support have both ethical and regulatory obligations to minimize pain in animal subjects. Beyond these obligations, minimizing pain is good science. Animals in pain are likely to experience a variety of physiological and behavioral perturbations that can alter or confound scientific data. The most effective strategy for minimizing pain is to prevent its occurrence in the first place. This requires knowledge of what types of procedures are likely to cause pain and the type and severity of pain that is likely to result. Planning procedures to limit stress and minimize tissue injury can do much to reduce the occurrence and impact of pain in the postprocedural period. Analgesic drugs have an important place in the overall strategy, and the effectiveness of these drugs can be greatly increased using newer approaches such as preemptive analgesia and multimodal analgesia. Careful preplanning, while of great importance, does not reduce the need for postprocedural monitoring. Ongoing efforts must be made to assure that the animal is not in excessive pain and to recognize the need for additional analgesic interventions. Behavioral monitoring by trained, experienced observers who are familiar with the procedure performed and the species in question is the backbone of postprocedural monitoring. The frequency of monitoring is important and must be tailored to the situation and the response of the individual animal. Use of a pain scoring system may help to assure a consistent approach to postprocedural monitoring, but it is important to recognize both the advantages and limitations of these systems. Some of the more novel approaches to pain monitoring include remote video monitoring, telemetry, and assessment of the animal’s ability to perform specific behaviors on cue.

REFERENCES

- Abelli, L., Conte, B., Somme, V., Maggi, C.A., Girliani, S., and Meli, A. (1989). A method for studying pain arising from the urinary bladder in conscious, freely-moving rats. *J. Urol.* **141**, 148–151.
- ACLAM. (American College of Laboratory Animal Medicine, July 2006). “Guidelines for the Assessment and Management of Pain in Rodents and Rabbits.” 2006, from http://www.aclam.org/print/position_pain-rodent-rabbit.pdf
- ACVA. (American College of Veterinary Anesthesiologists’, 1998). American College of Veterinary Anesthesiologists’ position paper on the treatment of pain in animals. *J. Am. Vet. Med. Assoc.* **213**, 628–630.
- Akca, O., Melischek, M., Scheck, T., Hellwagner, K., Arkilic, C.F., Kurz, A., Kapral, S., Heinz, T., Lackner, F.X., and Sessler, D.I. (1999). Postoperative pain and subcutaneous oxygen tension. *Lancet* **354**(9172), 41–42.
- Anand, K.J.S., Coskun, V., Thirvikraman, K.V., Nemeroff, C.B., and Plotsky, P.M. (1999). Long-term behavioral effects of repetitive pain in neonatal rat pups. *Physiol. Behav.* **66**(4), 627–637.

- Anil, L., Anil, S.S., and Deen, J. (2005). Pain detection and amelioration in animals on the farm: Issues and options. *J. Appl. Anim. Welf. Sci.* **8**(4), 261–278.
- Anil, S.S., Anil, L., and Deen, J. (2002). Challenges of pain assessment in domestic animals. *J. Am. Vet. Med. Assoc.* **220**(3), 313–319.
- Animals in research committee. (American College of Toxicology, 1988). American College of Toxicology: Policy Statement on the Use of Animals in Toxicology.
- Anonymous. (2001). 2000 report of the AVMA panel on euthanasia. *J. Am. Vet. Med. Assoc.* **218**(5), 669–696.
- Arena, P.C., and Richardson, K.C. (1990). The relief of pain in cold-blooded vertebrates. *ACCART News* **3**, 1–4.
- Bala, I., Gupta, B., Bhardwaj, N., Ghai, B., and Khosla, V.K. (2006). Effect of scalp block on postoperative pain relief in craniotomy patients. *Anaesth. Intensive Care* **34**(2), 224–227.
- Ballantyne, J.C., Carr, D.B., deFerranti, S., Suarez, T., Lau, J., Chalmers, T.C., Angelillo, I.F., and Mosteller, F. (1998). The comparative effects of postoperative analgesic therapies on pulmonary outcome: Cumulative meta-analyses of randomized, controlled trials. *Anesth. Analg.* **86**(3), 598–612.
- Baumans, V.B., Brain, P.F., Brugère, H., Clausing, P., Jeneskog, T., and Perretta, G. (1994). Pain and distress in laboratory rodents and lagomorphs: Report of the Federation of European Laboratory Animal Science Associations (FELASA) Working Group on Pain and Distress. *Lab. Anim.* **28**(2), 97–112.
- Beilin, B., Shavit, Y., Trabekin, E., Mordashev, B., Mayburd, E., Zeidel, A., and Bessler, H. (2003). The effects of postoperative pain management on immune response to surgery. *Anesth. Analg.* **97**(3), 822–827.
- Belzung, C., and Griebel, G. (2001). Measuring normal and pathological anxiety-like behaviour in mice: A review. *Behav. Brain Res.* **125**, 141–149.
- Blackburn-Munro, G. (2004). Pain-like behaviours in animals—how human are they? *Trends Pharmacol. Sci.* **25**(6), 299–305.
- Bonica, J.J. (1992). Pain research and therapy: History, current status, and future goals. In “Animal Pain.” (C.E. Short and A. Van Poznak, eds.), pp 1–29. Churchill Livingstone, New York.
- Bonnet, F., and Marret, E. (2005). Influence of anaesthetic and analgesic techniques on outcome after surgery. *Br. J. Anaesth.* **95**(1), 52–58.
- Brandt, M.R., Fernandes, A., Mordhorst, R., and Kehlet, H. (1978). Epidural analgesia improves postoperative nitrogen balance. *Br. Med. J.* **1**, 1106–1108.
- Breazile, J.E. (1987). Physiologic basis and consequences of distress in animals. *J. Am. Vet. Med. Assoc.* **191**, 1212–1215.
- Brown, D.J., McMillan, D.C., and Milroy, R. (2005). The correlation between fatigue, physical function, the systemic inflammatory response, and psychological distress in patients with advanced lung cancer. *Cancer* **103**(2), 377–382.
- Bustorff-Silva, J., Perez, C.A., Atkinson, J.B., and Raybould, H.E. (1999). Effects of intraabdominally insufflated carbon dioxide and elevated intraabdominal pressure on postoperative gastrointestinal transit: An experimental study in mice. *J. Pediatr. Surg.* **34**(10), 1482–1485.
- Cain, C.K., Francis, J.M., Plone, M.A., Emerich, D.F., and Linder, M.D. (1997). Pain-related disability and effects of chronic morphine in the adjuvant-induced model of chronic pain. *Physiol. Behav.* **62**(1), 199–205.
- Cambridge, A.J., Tobias, K.M., Newberry, R.C., and Sarkar D.K. (2000). Subjective and objective measurements of postoperative pain in cats. *J. Am. Vet. Med. Assoc.* **217**, 685–690.
- Campbell, J.N. (2001). Nerve lesions and the generation of pain. *Muscle Nerve* **24**, 1261–1273.
- Carli, F., Trudel, J.L., and Belliveau, P. (2001). The effect of intraoperative thoracic epidural anesthesia and postoperative analgesia on bowel function after colorectal surgery: A prospective, randomized trial. *Dis. Colon Rectum* **44**(8), 1083–1089.
- Carpenter, R.E., Wilson, D.V., and Evans, A.T. (2004). Evaluation of intraperitoneal and incisional lidocaine or bupivacaine for analgesia following ovariohysterectomy in the dog. *Vet. Anaesth. Analg.* **31**(1), 46–52.
- Carr, D.B., and Goudas, L.C. (1999). Acute pain. *Lancet* **353**, 2051–2058.
- Carroll, J.A., Berg, E.L., Strauch, T.A., Roberts, M.P., and Kattesh, H.G. (2006). Hormonal profiles, behavioral responses, and short-term growth performance after castration of pigs at three, six, nine, or twelve days of age. *J. Anim. Sci.* **84**(5), 1271–1278.
- Carstens, E., and Moberg, G.P. (2000). Recognizing pain and distress in laboratory animals. *ILAR J.* **41**(2), 62–71.
- Chapman, C.R., Casey, K.L., Dubner, R., Foley, K.M., Gracely, R.H., and Reading, A.E. (1985). Pain measurement: An overview. *Pain* **22**, 1–31.
- Conzemius, M.G., Hill, C.M., Samarco, J.L., and Perkowski, S.Z. (1997). Correlation between subjective and objective measures to determine severity of postoperative pain in dogs. *J. Am. Vet. Med. Assoc.* **210**(11), 1619–1622.
- Cooper, D.M., Hoffman, W., Wheat, N., and Lee, H.Y. (2005). Duration of effects on clinical parameters and referred hyperalgesia in rats after abdominal surgery and multiple doses of analgesic. *Comp. Med.* **55**(4), 344–353.
- Crawley, J.N. (1999). Behavioral phenotyping of transgenic and knockout mice: Experimental design and evaluation of general health, sensory functions, motor abilities, and specific behavioral tests. *Brain Res.* **835**(1), 18–26.
- Cullen, M.L., Staren, E.D., El-Ganzouri, A., Logas, W.G., Ivankovich, A.D., and Economou, S.G. (1985). Continuous epidural infusion for analgesia after major abdominal operations: A randomized, prospective, double-blind study. *Surgery* **98**, 718–726.
- Dabu-Bondoc, S.M. (2004). Regional anesthesia and perioperative outcome: What is new? *Curr. Opin. Anaesth.* **17**(5), 435–439.
- Dahl, J.B., and Moiniche, S. (2004). Pre-emptive analgesia. *Br. Med. Bull.* **71**, 13–27.
- de Leon-Casasola, O.A., Parker, B.M., Lema, M.J., Groth, R.I., and Orsini-Fuentes, J. (1994). Epidural analgesia versus intravenous patient-controlled analgesia. Differences in the postoperative course of cancer patients. *Reg. Anesth.* **19**(5), 307–315.
- De Winter, B.Y., Boeckxstaens, G.E., De Man, J.G., Moreels, T.G., Herman, A.G., and Pelckmans, P.A. (1997). Effects of mu- and kappa-opioid receptors on postoperative ileus in rats. *Eur. J. Pharmacol.* **339**(1), 63–67.
- Dobromylyskij, P., Flecknell, P.A., Lascelles, B.D.X., Livingston, A., Taylor, P., and Waterman-Pearson, A. (2000). Pain assessment. In “Pain Management in Animals.” (P.A. Flecknell and A. Waterman-Pearson, eds.), pp 53–79. W. B. Saunders, London.
- Dorland (1981). “Dorland’s Illustrated Medical Dictionary.” W. B. Saunders Company, Philadelphia, PA (26th edition).
- Dorsch, M.M., Otto, K., and Hedrich, H.J. (2004). Does preoperative administration of metamizol (Novalgine) affect postoperative body weight and duration of recovery from ketamine xylazine anaesthesia in mice undergoing embryo transfer: A preliminary report. *Lab. Anim.* **38**, 44–49.
- Dubner, R. (1994). Methods of assessing pain in animals. In “Textbook of Pain.” (P.D. Wall and R. Melzack, eds.), 3rd ed., pp 293–302. Churchill Livingstone, London.
- Duncan, I.J.H., Beatty, E.R., Hocking, P.M., and Duff, S.R.I. (1991). Assessment of pain associated with degenerative hip disorders in adult male turkeys. *Res. Vet. Sci.* **50**, 200–203.
- Dworkin, R.H., Backonja, M., Rowbotham, M.C., Allen, R.R., Argoff, C.R., Bennett, G.J., Bushnell, M.C., Farrar, J.T., Galer, B.S., Haythornthwaite, J.A., Hewitt, D.J., Loeser, J.D., Max, M.B., Saltarelli, M., Schmader, K.E., Stein, C., Thompson, D., Turk, D.C., Wallace, M.S., Watkins, L.R., and Weinstein, S.M. (2003). Advances in neuropathic pain: Diagnosis, mechanisms, and treatment recommendations. *Arch. Neurol.* **60**(11), 1524–1534.
- Eicher, S.D., and Dailey, J.W. (2002). Indicators of acute pain and fly avoidance behaviors in Holstein calves following tail docking. *J. Dairy Sci.* **85**(1), 2850–2858.

- El Mouedden, M., and Meert, T.F. (2007). Pharmacological evaluation of opioid and non-opioid analgesics in a murine bone cancer model of pain. *Pharmacol. Biochem. Behav.* **86**, 458–467.
- Farag, E., Dilger, J., Brooks, P., and Tetzlaff, J.E. (2005). Epidural analgesia improves early rehabilitation after total knee replacement. *J. Clin. Anesth.* **17**(4), 281–285.
- Firth, A.M., and Haldane, S.L. (1999). Development of a scale to evaluate postoperative pain in dogs. *J. Am. Vet. Med. Assoc.* **214**, 651–659.
- Fisher, A.D. (2002). Pain—its effects on immune function and growth in animals. *Proc. N. Z. Soc. Anim. Prod.* **62**, 363–367.
- Fisher, A.D., Crowe, M.A., O’Nuallain, E.M., Monaghan, M.L., Larkin, J.A., O’Kiely, P., and Enright, W.J. (1997a). Effects of cortisol on in vitro interferon-gamma production, acute-phase proteins, growth, and feed intake in a calf castration model. *Anim. Sci.* **75**(4), 1041–1047.
- Fisher, A.D., Crowe, M.A., O’Nuallain, E.M., Monaghan, M.L., Prendiville, D.J., O’Kiely, P., and Enright, W.J. (1997b). Effects of suppressing cortisol following castration of bull calves on adrenocorticotropic hormone, in vitro interferon-gamma production, leukocytes, acute-phase proteins, growth, and feed intake. *J. Anim. Sci.* **75**(7), 1899–1908.
- Flecknell, P.A., Orr, H.E., Roughan, J.V., and Stewart, R. (1999). Comparison of the effects of oral or subcutaneous carprofen or ketoprofen in rats undergoing laparotomy. *Vet. Rec.* **144**(3), 65–67.
- Foex, B.A., Kirkman, E., and Little, R.A. (2004). Injury (nociceptive afferent nerve stimulation) modifies the hemodynamic and metabolic responses to hemorrhage in immature swine. *Crit. Care Med.* **32**(3), 740–746.
- Franchi, S., Panerai, A.E., and Sacerdote, P. (2007). Buprenorphine ameliorates the effect of surgery on hypothalamus–pituitary–adrenal axis, natural killer cell activity and metastatic colonization in rats in comparison with morphine or fentanyl treatment. *Brain Behav. Immun.* **21**(6), 767–774.
- Fukuda, H., Suenaga, K., Tsuchida, D., Mantyh, C.R., Pappas, T.N., Hicks, G.A., Dehaven-Hudkins, D.L., and Takahashi, T. (2006). The selective mu opioid receptor antagonist, alvimopan, improves delayed GI transit of postoperative ileus in rats. *Brain Res.* **1102**(1), 63–70.
- Gang, Y., and Malik, M. (2002). Heart rate variability in critical care medicine. *Curr. Opin. Crit. Care* **8**, 371–375.
- Gassel, A.D., Tobias, K.M., Egger, C.M., Rohrback, B.W. (2005). Comparison of oral and subcutaneous administration of buprenorphine and meloxicam for preemptive analgesia in cats undergoing ovariohysterectomy. *J. Am. Vet. Med. Assoc.* **227**(12), 1937–1944.
- Gebhart, G.F. (1994). Pain and distress in research animals. In “Research Animal Anesthesia, Analgesia and Surgery.” (A.C. Smith and M.M. Swindle, eds.), pp 37–40. Scientists Center for Animal Welfare, Greenbelt, MD.
- Georgeson, K.E., and Owings, E. (2000). Advances in minimally invasive surgery in children. *Am. J. Surg.* **180**, 362–364.
- Giraudel, J.M., Diquelou, A., Lees, P., and Toutain, P.L. (2005). Development and validation of a new model of inflammation in the cat and selection of surrogate endpoints for testing anti-inflammatory drugs. *J. Vet. Pharmacol. Ther.* **28**, 275–285.
- Goecke, J.C., Awad, H.L., Jody, C., and Boivin, G.P. (2005). Evaluating postoperative analgesics in mice using telemetry. *Comp. Med.* **55**(1), 37–44.
- Gonzalez, M.I., Field, M.J., Bramwell, S., McCleary, S., and Singh, L. (2000). Ovariohysterectomy in the rat: A model of surgical pain for evaluation of preemptive analgesia. *Pain* **88**, 79–88.
- Gottshalk, A., Berkow, L.C., Stevens, R.D., Mirski, M., Thompson, R.E., White, E.D., Weingart, J.D., Long, D.M., and Yaster, M. (2007). Prospective evaluation of pain and analgesic use following major elective intracranial surgery. *J. Neurosurg.* **106**(2), 210–216.
- Grandin, T. (1997). Assessment of stress during handling and transport. *J. Anim. Sci.* **75**, 249–257.
- Gray, L.C., and Matta, B.F. (2005). Acute and chronic pain following craniotomy. *Anaesthesia* **60**, 693–704.
- Grossman, P. (2004). The LifeShirt: A multi-function ambulatory system monitoring health, disease, and medical interventions in the real world. *Stud. Health Technol. Inform.* **108**, 133–41.
- Grunau, R.E., Holsti, L., Haley, D.W., Oberlander, T., Weinberg, J., Solimano, A., Whitfield, M.F., Fitzgerald, C., and Yu, W. (2005). Neonatal procedural pain exposure predicts lower cortisol and behavioral reactivity in preterm infants in the NICU. *Pain* **113**(3), 293–300.
- Guillou, N., Tanguay, M., Seguin, P., Branger, J.P., Campion, J.-P., and Malledant, Y. (2003). The effects of small dose ketamine on morphine consumption in surgical intensive care unit patients after major abdominal surgery. *Anesth. Analg.* **97**, 843–847.
- Hansen, B.D. (2003). Assessment of pain in dogs: Veterinary clinical studies. *ILAR J.* **44**(3), 197–205.
- Hansen, B.D. (2005). Analgesia and sedation in the critically ill. *J. Vet. Emerg. Crit. Care* **15**(4), 285–294.
- Hardie, E.M. (2000). Recognition of pain behaviour in animals. In “Animal Pain: A Practice Oriented Approach to an Effective Pain Control in Animals.” (L. Hellebrekers, ed.), pp 51–69. Blackwell Publishing Limited, Utrecht, the Netherlands.
- Harkin, A.J., O’Donnell, J.M., and Kelly, J.P. (2003). A combined and comparative study of physiologic and behavioral parameters in a systemic toxicity test. *Contemp. Top.* **42**, 31–38.
- Harvey-Clark, C.J., Giles, K., and Riggs, K.W. (2000). Transdermal fentanyl compared with parenteral buprenorphine in post surgical pain in swine: A case study. *Lab. Anim.* **34**, 386–398.
- Hawkins, P. (2002). Recognising and assessing pain, suffering and distress in laboratory animals: A survey of current practice in the U.K. with recommendations. *Lab. Anim.* **36**(4), 378–395.
- Hay, M., Vulin, A., Genin, S., Sales, P., and Prunier, A. (2003). Assessment of pain induced by castration in piglets: Behavioral and physiological responses over the subsequent 5 days. *Appl. Anim. Behav. Sci.* **82**, 201–218.
- Hayes, J.H., and Flecknell, P.A. (1999). A comparison of pre- and post-surgical administration of bupivacaine or buprenorphine following laparotomy in the rat. *Lab. Anim.* **33**(1), 16–23.
- Hayes, K.E., Raucci, J.A., Jr., Gades, N.M., and Toth, L.A. (2000). An evaluation of analgesic regimens for abdominal surgery in mice. *Contemp. Top. Lab. Anim. Sci.* **39**(6), 18–23.
- Hellyer, P.W. (2002). Objective, categoric methods for assessing pain and analgesia. In “Handbook of Veterinary Pain Management.” (J.S. Gaynor and W.W. Muir, eds.), pp 82–107. Mosby, St. Louis, MO.
- Herzberg, U., Murtaugh, M., and Beitz, A.J. (1994). Chronic pain and immunity: Mononeuropathy alters immune responses in rats. *Pain* **59**, 219–225.
- Hølen, J.C., Polit, C., Hjermsstad, M.J., Loge, J.H., Fayers, P.M., Caraceni, A., De Conno, F., Forbes, K., Furst, C.J., Radbruch, L., and Kaasa, S. (2006). Pain assessment tools: Is the content appropriate for use in palliative care? *J. Pain Symptom Manage.* **32**(6), 567–580.
- Holton, L., Reid, J., Scott, E.M., Welsh, E., and Flaherty, D. (2001). Development of a behavior based scale to measure acute pain in dogs. *Vet. Rec.* **148**, 525–531.
- Holton, L.L., Scott, E.M., Nolan, A.M., Reid, J., Welsh, E., and Flaherty, D. (1998). Comparison of three methods used for assessment of pain in dogs. *J. Am. Vet. Med. Assoc.* **212**, 61–66.
- Hudson, J.T., Slater, M.R., Taylor, L., Scott, H.M., and Kerwin, S.C. (2004). Assessing the repeatability and validity of a visual analog scale questionnaire for use in assessing pain and lameness in dogs. *Am. J. Vet. Res.* **65**(12), 1634–1643.
- IASP. (International Association for the Study of Pain, 1992). Adult postoperative pain. In “Management of Acute Pain: A Practical Guide.” A report of the Task Force on Acute Pain. pp 22–33. IASP Publications, Seattle, Washington, D.C.
- IASP. (International Association for the Study of Pain, 1994). IASP Pain Terminology http://www.iasp-pain.org/AM/Template.cfm?Section=General_Resource_Links&Template=/CM/HTMLDisplay.cfm&ContentID=3058.
- Jablonski, P., and Howden, B.O. (2002). Oral buprenorphine and aspirin analgesia in rats undergoing liver transplantation. *Lab. Anim.* **36**(2), 134–143.

- Jablonski, P., Howden, B.O., and Baxter, K. (2001). Influence of buprenorphine analgesia on post-operative recovery in two strains of rats. *Lab. Anim.* **35**(3), 213–222.
- Jacobson, C. (2000). Adverse effects on growth rates in rats caused by buprenorphine administration. *Lab. Anim.* **34**(2), 202–206.
- Kahn, M.S., Bann, S.D., Darzi, A., and Butler, P.E. (2003). Assessing surgical skill. *Plast. Reconstr. Surg.* **112**(7), 1886–1889.
- Karas, A.Z., Gostyla, K., Aronovitz, M., Wolfe, E., and Karas, R.H. (2001). Diminished body weight and activity patterns in mice following surgery: Implications for control of post-procedural pain/distress in laboratory animals. *Contemp. Top. Lab. Anim. Sci.* **40**, 83.
- Karas, A.Z., Weaver, L.A., Andrutis, K.A., and Blaze, C.A. (2007). A model for clinical evaluation of perioperative analgesia in the rabbit. Poster P1-1030 presented at the 6th World Congress on Alternatives and Animals in the Life Sciences, Tokyo, Japan.
- Kehlet, H. (2006). Labat lecture 2005: Surgical stress and postoperative outcome—from here to where? *Reg. Anesth. Pain Med.* **31**(1), 47–52.
- Kehlet, H., and Dahl, J.B. (2003). Anaesthesia, surgery, and challenges in postoperative recovery. *Lancet* **362**(9399), 1921–1928.
- Kehlet, H., and Holte, K. (2001). Review of postoperative ileus. *Am. J. Surg.* **182**(5A Suppl), 3S–10S.
- Kehlet, K., Jensen, T.S., and Woolf, C.J. (2006). Persistent postsurgical pain: Risk factors and prevention. *Lancet* **367**, 1618–1625.
- Kent, J.E., Jackson, R.E., Molony, V., and Hosie, B.D. (2000). Effects of acute pain reduction methods on the chronic inflammatory lesions and behaviour of lambs castrated and tail docked with rubber rings at less than two days of age. *Vet. J.* **160**(1), 33–41.
- Kent, J.E., Molony, V., and Graham, M.J. (1998). Comparison of methods for the reduction of acute pain produced by rubber ring castration or tail docking of week-old lambs. *Vet. J.* **155**, 39–51.
- Kissin, I. (2005). Preemptive analgesia at the crossroad. *Anaesth. Analg.* **100**, 754–756.
- Kitchell, R.L. (1987). Problems in defining pain and peripheral mechanisms of pain. *J. Am. Vet. Med. Assoc.* **191**(10), 1195–1199.
- Knotkova, H., and Pappagallo, M. (2007). Adjuvant analgesics. *Med. Clin. North Am.* **91**, 113–124.
- Kolesnikov, Y.A., Chereshev, I., and Pasternak, G.W. (2000). Analgesic synergy between topical lidocaine and topical opioids. *J. Pharmacol. Exp. Ther.* **295**(2), 546–551.
- Koppert, W., Weigand, M., Neumann, F., Sitl, R., Schuettler, J., Schmelz, J., and Hering, W. (2004). Perioperative intravenous lidocaine has preventive effects on postoperative pain and morphine consumption after major abdominal surgery. *Anesth. Analg.* **98**, 1050–1055.
- Krugner-Higby, L., Clark, M., Heath, T.D., Dahly, E., Schiffman, B., Hubbard-VanStelle, S., Ney, D., and Wendland, A. (2003). Liposomal-encapsulated oxymorphone hydrochloride provides prolonged relief of postsurgical visceral pain in rats. *Comp. Med.* **53**(3), 270–279.
- Lascalles, B.D., Cripps, P.J., Jones, A., and Waterman, A.E. (1997). Post-operative central hypersensitivity and pain—The pre-emptive value of pethidine for ovariohysterectomy. *Pain* **73**, 461–471.
- Lascalles, B.D., Waterman, A.E., Cripps, P.J., Livingston, A., and Henderson, G. (1995). Central sensitization as a result of surgical pain: Investigation of the preemptive value of pethidine for ovariohysterectomy in the rat. *Pain* **62**, 201–212.
- Lay, D.C., Jr., Friend, T.H., Bowers, C.L., Grissom, K.K., and Jenkins, O.C. (1992). A comparative physiological and behavioral study of freeze and hot-iron branding using dairy cows. *J. Anim. Sci.* **70**(4), 1121–1125.
- Leenaars, M., and Hendriksen, C.F.M. (2005). Critical steps in the production of polyclonal and monoclonal antibodies: Evaluation and recommendations. *ILAR J.* **46**(3), 269–279.
- Lewis, K.S., Whipple, J.K., Michael, K.A., and Quebbeman, E.J. (1994). Effect of analgesic treatment on the physiological consequences of acute pain. *Am. J. Hosp. Pharm.* **51**(12), 1539–1554.
- Liebeskind, J.C. (1991). Pain can kill. *Pain* **44**, 3–4.
- Liles, J.H., and Flecknell, P.A. (1994). A comparison of the effects of buprenorphine, carprofen and flunixin following laparotomy in rats. *J. Vet. Pharmacol. Ther.* **17**(4), 284–290.
- Liles, J.H., Flecknell, P.A., Roughan, J., and Cruz-Madorran, I. (1998). Influence of oral buprenorphine, oral naltrexone or morphine on the effects of laparotomy in the rat. *Lab. Anim.* **32**(2), 149–161.
- Lindner, M.D., Plone, M.A., Francis, J.M., and Cain, C.K. (1999). Chronic morphine reduces pain-related disability in a rodent model of chronic, inflammatory pain. *Exp. Clin. Psychopharmacol.* **7**(3), 187–197.
- Linton, S.J. (2000). A review of psychological risk factors in back and neck pain. *Spine* **25**(9), 1148–1156.
- Logan, H.L., Lutgendorf, S., Kirchner, H.L., Rivera, E.M., and Lubaroff, D. (2001). Pain and immunologic response to root canal treatment and subsequent health outcomes. *Psychosom. Med.* **63**(3), 453–462.
- Luger, N.M., Sabino, M.A., Schwei, M.J., Mach, D.B., Pomonis, J.D., Keyser, C.P., Rathbun, M., Clohisey, D.R., Honore, P., Yaksh, T.L., and Manty, P.W. (2002). Efficacy of systemic morphine suggests a fundamental difference in the mechanisms that generate bone cancer vs. inflammatory pain. *Pain* **99**, 397–406.
- Malavasi, L.M., Nyman, G., Augustsson, H., Jacobson, M., and Jensen-Waern, M. (2006). Effects of epidural morphine and transdermal fentanyl analgesia on physiology and behaviour after abdominal surgery in pigs. *Lab. Anim.* **40**(1), 16–27.
- Martini, L., Lorenzini, R.N., Cinotti, S., Fini, M., Giavaresi, G., and Giardino, R. (2000). Evaluation of pain and stress levels of animals used in experimental research. *J. Surg. Res.* **88**, 114–119.
- Martin, T.J., Kahn, W.R., and Eisenach, J.C. (2005). Abdominal surgery decreases food-reinforced operant responding in rats. *Anesthesiology* **103**, 629–637.
- Mathews, K.A. (2000). Pain assessment and general approach to management. *Vet. Clin. North Am. Small Anim. Pract.* **30**(4), 729–755.
- Matthews, E.A., and Dickenson, A.H. (2002). A combination of gabapentin and morphine mediates enhanced inhibitor effects on dorsal horn neuronal responses in a rat model of neuropathy. *Anesthesiology* **96**(3), 633–640.
- McCartney, C.J.L., Sinha, A., and Katz, J. (2004). A qualitative systematic review of the role of *N*-methyl-D-aspartate receptor antagonists in preventive analgesia. *Anesth. Analg.* **98**, 1385–1400.
- McGuire, L., Heffner, K., Glaser, R., Needleman, B., Malarkey, W., Dickinson, S., Lemeshow, S., Cook, C., Muscarella, P., Melvin, W.S., Ellison, E.C., and Kiecolt-Glaser, J.K. (2006). Pain and wound healing in surgical patients. *Ann. Behav. Med.* **31**(2), 165–172.
- McMillan, F.D. (2003). A world of hurts—Is pain special? *JAVMA* **223**(2), 183–186.
- Mellor, D.J., Molony, V., and Robertson, I.S. (1991). Effects of castration on behavior and plasma cortisol concentrations in young lambs, kids and calves. *Res. Vet. Sci.* **51**, 149–154.
- Moiniche, S., Kehlet, H., Berg Dahl, J. (2002). A qualitative and quantitative systematic review of preemptive analgesia for postoperative pain relief. *Anesthesiology* **96**, 725–741.
- Molina, P.E. (2006). Opioids and opiates: Analgesia and cardiovascular, haemodynamic and immune implications in critical illness. *J. Intern. Med.* **259**(2), 138–154.
- Molony, V., and Kent, J.E. (1997). Assessment of acute pain in farm animals using behavioral and physiological measurements. *J. Anim. Sci.* **75**(1), 266–272.
- Morgan, K.N., and Tromborg, C.T. (2007). Sources of stress in captivity. *Appl. Anim. Behav. Sci.* **102**, 262–302.
- Morley, S., Eccleston, C., Williams, A. (1999). Systematic review and meta-analysis of randomized controlled trials of cognitive behaviour therapy and behaviour therapy for chronic pain in adults, excluding headache. *Pain* **80**, 1–13.
- Morton, C.M., Reid, J.E., Scott, M., Holton, L.L., and Nolan, A.M. (2005). Application of a scaling model to establish and validate an interval level

- pain scale for assessment of acute pain in dogs *Am. J. Vet. Res.* **66**(12), 2154–2166.
- Morton, D.B., and Griffiths, P.H.M. (1985). Guidelines on the recognition of pain, distress and discomfort in experimental animals and an hypothesis for assessment. *Vet. Rec.* **116**, 431–436.
- Muir, W.W., and Gaynor, J.S. (2002). Pain behaviors. In “Handbook of Veterinary Pain Management.” (J.S. Gaynor and W.W. Muir, eds.), pp 65–81. Mosby, St. Louis, MO.
- Muir, W.W., Wiese, A.J., and March, P.A. (2003). Effects of morphine, lidocaine, ketamine, and morphine-lidocaine-ketamine drug combination on minimum alveolar concentration in dogs anesthetized with isoflurane. *Am. J. Vet. Res.* **64**, 1155–1160.
- NRC (National Research Council). (1992). “Recognition and Alleviation of Pain and Distress in Laboratory Animals.” A report of the Institute for Laboratory Animal Resources Committee on Pain and Distress in Laboratory Animals. National Academy Press, Washington, D.C.
- Negus, S., Vanderah, T.W., Brandt, M.R., Bilsky, E.J., Becerra, L., and Borsook, D. (2006). Preclinical assessment of candidate analgesic drugs: Recent advances and future challenges. *J. Pharmacol. Exp. Ther.* **319**(2), 507–514.
- Nekolaichuk, C.L., Bruera, E., Spachynski, K., MacEachern, T., Hanson, J., and Maguire, T.O. (1999). A comparison of patient and proxy symptom assessments in advanced cancer patients. *Palliat. Med.* **13**, 311–323.
- Ness, T.J. (1999). Models of visceral nociception. *ILAR J.* **40**(3), 119–128.
- Oberlander, T., and Saul, J.P. (2002). Methodological considerations for the use of heart rate variability as a measure of pain reactivity in vulnerable infants. *Clin. Perinatol.* **29**, 427–443.
- OECD (2000). Guidance Document on the Recognition, Assessment, and Use of Clinical Signs as Humane Endpoints for Experimental Animals Used in Safety Evaluation; [http://www.olis.oecd.org/olis/2000doc.nsf/4f7adc214b91a685c12569fa005d0ee7/c125692700623b74c12569bb005aa3d5/\\$FILE/00087372.pdf](http://www.olis.oecd.org/olis/2000doc.nsf/4f7adc214b91a685c12569fa005d0ee7/c125692700623b74c12569bb005aa3d5/$FILE/00087372.pdf)
- Ong, C.K.-S., Lirk, P., Seymour, R.A., and Jenkins, B.J. (2005). The efficacy of preemptive analgesia for acute postoperative pain management: A meta-analysis. *Anesth. Analg.* **100**, 757–773.
- Pace, M.C., Mazzariello, L., Passavanti, M.B., Sansone, P., Barbarisi, M., and Aurilio, C. (2006). Neurobiology of pain. *J. Cell. Physiol.* **209**, 8–12.
- Page, G.G. (2005). Acute pain and immune impairment. *Pain Clin. Updates XIII*(1), 1–4.
- Page, G.G., Ben-Eliyahu, S., Yirmiya, R., and Liebeskind, J.C. (1993). Morphine attenuates surgery-induced enhancement of metastatic colonization in rats. *Pain* **54**(1), 21–28.
- Page, G.G., Blakely, W.P., and Ben-Eliyahu, S. (2001). Evidence that postoperative pain is a mediator of the tumor-promoting effects of surgery in rats. *Pain* **90**(1–2), 191–199.
- Perkins, F.M., and Kehlet, H. (2000). Chronic pain as an outcome of surgery: A review of predictive factors. *Anesthesiology* **93**, 1123–1133.
- Ploghaus, A., Narain, C., Beckmann, C.F., Clare, S., Bantick, S., Wise, R., Matthews, P.M., Rawlins, J.N.P., and Tracey, I. (2001). Exacerbation of pain by anxiety is associated with activity in a hippocampal network. *J. Neurosci.* **21**(24), 9896–9903.
- Pogatzki-Zahn, E.M., and Zahn, P.K. (2006). From preemptive to preventive analgesia. *Curr. Opin. Anaesthesiol.* **19**(5), 551–555.
- Price, D.D., Mao, J., Lu, J., Caruso, F.S., Frenk, H., and Mayer, D.J. (1996). Effects of the combined oral administration of NSAIDs and dextromethorphan on behavioral symptoms indicative of arthritic pain in rats. *Pain* **68**, 119–127.
- Public Health Service. (1996). “Public Health Service Policy on Humane Care and Use of Laboratory Animals.” U.S. Department of Health and Human Services, Washington, D.C.
- Rady, M.Y., Kirkman, E., Cranley, J., and Little, R.A. (1993). A comparison of the effects of skeletal muscle injury and somatic afferent nerve stimulation on the response to hemorrhage in anesthetized pigs. *J. Trauma* **35**(5), 756–761.
- Rady, M.Y., Little, R.A., Edwards, J.D., Kirkman, E., and Faithful, S. (1991). The effect of nociceptive stimulation on the changes in hemodynamics and oxygen transport induced by hemorrhage in anesthetized pigs. *J. Trauma* **31**(5), 617–621; discussion 621–612.
- Rahimi, S.Y., Vender, J.R., Macomson, S.D., French, A., Smith, J.R., and Alleyne, C.H. (2006). Postoperative pain management after craniotomy: Evaluation and cost analysis. *Neurosurgery* **59**(4), 852–857.
- Reuben, S.S., and Buvanendran, A. (2007). Preventing the development of chronic pain after orthopaedic surgery with preventive multimodal analgesic techniques. *J. Bone Joint Surg.* **89**, 1343–1358.
- Rietmann, T.R., Stauffacher, M., Bernasconi, P., Auer, J.A., and Weishaupt, M.A. (2004). The association between heart rate, heart rate variability, endocrine and behavioural pain measures in horses suffering from laminitis. *J. Vet. Med. A.* **51**(5), 218–225.
- Rosenberg, A.D. (2000). Reducing post-traumatic morbidity with pain management. *Curr. Opin. Anaesthesiol.* **13**(2), 181–184.
- Roughan, J.V., and Flecknell, P.A. (2001). Behavioural effects of laparotomy and analgesic effects of ketoprofen and carprofen in rats. *Pain* **90**(1–2), 65–74.
- Roughan, J.V., and Flecknell, P.A. (2003). Evaluation of a short duration behaviour-based post-operative pain scoring system in rats. *Eur. J. Pain* **7**(5), 397–406.
- Roughan, J.V., and Flecknell, P.A. (2004). Behaviour-based assessment of the duration of laparotomy-induced abdominal pain and the analgesic effects of carprofen and buprenorphine in rats. *Behav. Pharmacol.* **15**(7), 461–472.
- Roughan, J.V., Flecknell, P.A., and Davies, B.R. (2004). Behavioural assessment of the effects of tumour growth in rats and the influence of the analgesics carprofen and meloxicam. *Lab. Anim.* **38**(3), 286–296.
- Saclarides, T.J. (2006). Current choices—good or bad—for the proactive management of postoperative ileus: A surgeon’s view. *J. Perianesth. Nurs.* **21**(2A Suppl), S7–S15.
- Schreiner, D.A., and Ruegg, P.L. (2002). Responses to tail docking in calves and heifers. *J. Dairy Sci.* **85**, 3287–3296.
- Scott, N.B., and Kehlet, H. (1988). Regional anaesthesia and surgical morbidity. *Br. J. Surg.* **75**, 299–304.
- Shafford, H.L., Hellyer, P.W., and Turner, A.S. (2004). Intraarticular lidocaine plus bupivacaine in sheep undergoing stifle arthrotomy. *Vet. Anaesth. Analg.* **31**, 20–26.
- Shanin, S.N., Rybakina, E.G., Novikova, N.N., Kozinets, I.A., Rogers, V.J., and Korneva, E.A. (2005). Natural killer cell cytotoxic activity and c-Fos protein synthesis in rat hypothalamic cells after painful electric stimulation of the hind limbs and EHF irradiation of the skin. *Med. Sci. Monit.* **11**(9), BR309–BR315.
- Sharp, J., Zammit, T., Azar, T., and Lawson, D. (2003). Recovery of male rats from major abdominal surgery after treatment with various analgesics. *Contemp. Top. Lab. Anim. Sci.* **42**(6), 22–27.
- Shavit, Y., Fish, G., Wolf, G., Mayburd, E., Meerson, Y., Yirmiya, R., and Beilin, B. (2005). The effects of perioperative pain management technique on food consumption and body weight after laparotomy in rats. *Anesth. Analg.* **101**(4), 1112–1116.
- Siddall, P.J., and Cousins, M.J. (2004). Persistent pain as a disease entity: Implications for clinical management. *Anesth. Analg.* **99**(2), 510–520.
- Sinatra, R.S. (2006). Peripherally acting mu-opioid-receptor antagonists and the connection between postoperative ileus and pain management: The anesthesiologist’s view and beyond. *J. Perianesth. Nurs.* **21**(2A Suppl), S16–S23.
- Smith, J.D., Allen, S.W., and Quandt, J.E. (1999). Changes in cortisol concentration in response to stress and postoperative pain in client-owned cats and correlation with objective clinical variables. *Am. J. Vet. Res.* **60**, 432–436.
- Smith, J.D., Allen, S.W., Quandt, J.E., and Tackett, R.L. (1996). Indicators of postoperative pain in cats and correlation with clinical criteria. *Am. J. Vet. Res.* **57**, 1674–1678.

- Sneddon, L.U., Braithwaite, V.A., Gentle, M.A. (2003). Do fishes have nociceptors? Evidence for the evolution of a vertebrate sensory system. *Proc. R. Soc. Lond B* **270**, 1115–1121.
- Stevens, C.W. (1995). An amphibian model for pain research. *Lab. Anim.* **24**, 32–36.
- Stewart, L.A., and Martin, W.J. (2003). Influence of postoperative analgesics on development of neuropathic pain in rats. *Comp. Med.* **53**(1) 29–36.
- Stone, P., Richards, M., A'Hern, R., and Hardy, J. (2000). A study to investigate the prevalence, severity and correlates of fatigue among patients with cancer in comparison with a control group of volunteers without cancer. *Ann. Oncol.* **11**(5), 561–567.
- Storella, R.J., Shi, Y., O'Connor, D.M., Pharo, G.H., Abrams, J.T., and Levitt, J. (1999). Relief of chronic pain may be accompanied by an increase in a measure of heart rate variability. *Anesth. Analg.* **89**, 448–450.
- Straube, S., Derry, S., McQuay, H.J., and Moore, R.A. (2005). Effect of preoperative Cox-II-selective NSAIDs (coxibs) on postoperative outcomes: A systematic review of randomized studies. *Acta Anaesthesiol. Scand.* **49**, 601–613.
- Thuer, S., Mellema, S., Doherr, M.G., Wechsler, B., Nuss, K., and Steiner, A. (2007). Effect of local anaesthesia on short- and long-term pain induced by two bloodless castration methods in calves. *Vet. J.* **173**(2), 333–342.
- Thut, P.D., Hermanstyn, T.O., Flake, N.M., and Gold, M.S. (2007). An operant conditioning model to assess changes in feeding behavior associated with temporomandibular joint inflammation in the rat. *J. Orofac. Pain* **21**(1), 7–18.
- Ting, S.T., Earley, B., and Crowe, M.A. (2003a). Effect of repeated ketoprofen administration during surgical castration of bulls on cortisol, immunological function, feed intake, growth, and behavior. *J. Anim. Sci.* **81**(5), 1253–1264.
- Ting, S.T., Earley, B., Hughes, J.M., and Crowe, M.A. (2003b). Effect of ketoprofen, lidocaine local anesthesia, and combined xylazine and lidocaine caudal epidural anesthesia during castration of beef cattle on stress responses, immunity, growth, and behavior. *J. Anim. Sci.* **81**(5), 1281–1293.
- Uemura, K., Tatewaki, M., Harris, M.B., Ueno, T., Mantyh, C.R., Pappas, T.N., and Takahashi, T. (2004). Magnitude of abdominal incision affects the duration of postoperative ileus in rats. *Surg. Endosc.* **18**(4), 606–610.
- Underwood, W.J. (2002). Pain and distress in agricultural animals. *J. Am. Vet. Med. Assoc.* **221**(2), 208–211.
- van Dijk, M., Koot, H.M., Saad, H., Huijjer, A., Tibboel, D., and Passchier, J. (2002). Observational visual analog scale in pediatric pain assessment: Useful tool or good riddance? *Clin. J. Pain* **18**, 310–316.
- vanLoo, P.L.P., Everse, L.A., Bernsen, M.R., Baumans, V., Hellebrekers, L.J., Kruitwagen, C.L.J.J., and den Otter, W. (1997). Analgesics in mice used in cancer research: Reduction of discomfort? *Lab. Anim.* **31**, 318–325.
- Walker, C.-D., Kudreikis, K., Sherrard, A., and Johnston, C.C. (2003). Repeated neonatal pain influences maternal behavior, but not stress responsiveness in rat offspring. *Dev. Brain Res.* **140**, 253–261.
- Walsh, P.J., Remedios, A.M., Ferguson, J.F., Walker, D.D., Cantwell, S., and Duke, T. (1999). Thoracoscopic versus open partial pericardectomy in dogs: Comparison of postoperative pain and morbidity. *Vet. Surg.* **28**, 472–479.
- Weary, D.M., Braithwaite, L.A., and Fraser, D. (1998). Vocal response to pain in piglets. *Appl. Anim. Behav. Sci.* **56**, 161–172.
- Weary, D.M., Niel, L., Flower, F.C., and Fraser, D. (2006). Identifying and preventing pain in animals. *Appl. Anim. Behav. Sci.* **100**, 64–76.
- Weise, M., Krämer, J., Bernsmann, K., and Ernst Willburger, R. (2004). The related outcome and complication rate in primary lumbar microscopic disc surgery depending on the surgeon's experience: Comparative studies. *Spine J.* **4**(5), 550–556.
- White, P.F., Kehlet, H., Neal, J.M., Schrickler, T., Carr, D.B., and Carli, F. (2007). The role of the anesthesiologist in fast-track surgery: From multimodal analgesia to perioperative medical care. *Anesth. Analg.* **104**(6), 1380–1396.
- Whitfield, M.F., and Grunau, R.E. (2000). Behavior, pain perception, and the extremely low-birth weight survivor. *Clin. perinatol.* **27**(2), 363–379.
- Wilhelm, F.H., Roth, W.T., and Sackner, M.A. (2003). The LifeShirt; and advanced system for ambulatory measurement of respiratory and cardiac function. *Behav. Mod.* **27**, 671–691.
- Wiseman-Orr, M.L., Nolan, A.M., Reid, J., and Scott, E.M. (2001). Preliminary study on owner-reported behavior changes associated with chronic pain in dogs. *Vet. Rec.* **149**, 423–424.
- Wiseman-Orr, M.L., Scott, E.M., Reid, J., and Nolan, A.M. (2006). Validation of a structured questionnaire as an instrument to measure chronic pain in dogs on the basis of effects on health-related quality of life. *Am. J. Vet. Res.* **67**(11), 1826–1836.
- Wixson, S.K. (1999). The role of the IACUC in assessing and managing pain and distress in research animals. In "The Care and Feeding of an IACUC." (M.L. Podolsky and V.S. Lukas, eds.), Chap. 9, pp 115–134. CRC Press LLC, Boca Raton, FL.
- Yeager, M.P., Glass, D.D., Neff, R.K., and Brinck-Johnsen, T. (1987). Epidural anesthesia and analgesia in high-risk surgical patients. *Anesthesiology* **66**, 729–736.

Postprocedural Care of Commonly Utilized Research Animal Subjects

Victoria A. Hampshire and Judith A. Davis

I. Introduction	219
II. Recruitment and Organization of Space	220
A. Rats and Mice	220
B. Large-Animal Postprocedural Housing	221
C. Cabinets and Ancillary Equipment	222
III. Staffing and Personnel	223
IV. Oversight, Planning, and Organization	224
A. Assessing the Model; Determining the Interventions and Endpoints ..	224
B. Institutional Animal Care and Use Committee Approval	225
C. Scheduling	226
V. Monitoring and Intervention	226
A. Personnel and Shifts	226
B. Acclimation and Baseline Assessments	226
C. Trending Criteria	226
VI. Record Keeping	233
A. Rats and Mice	233
B. Large Animals	233
VII. Conclusions	233
References	233

I. INTRODUCTION

Procedural aftermaths in biomedical research settings can compromise the outcomes of a wide variety of invasive and noninvasive protocol designs, each with varying levels of pain and/or distress and each requiring multiple levels of care in order to meet or exceed what is a generally acceptable standard

of care (Commission on Life Sciences, 1996a). Modern considerations for what might be termed usual and customary postprocedural care for rats and mice still differ considerably from the customs and traditions associated with the veterinary care that has been the standard for small ungulates, carnivores, and primates, which comprise the second largest body of animal research subjects globally. The authors recognize that programs

operating under USDA regulations are not required to prioritize rodent postprocedural care at the same level as programs receiving federal funding for large animals. However, since rodents comprise the mainstay of biomedical research programs in the world, many programs that seek accreditation aspire to meet performance standards emphasized within the scope of current standards of practice (Commission on Life Sciences, 1996a; PHS Policy, 2002; ACLAM, 2007). Thus, most of the discussion in this chapter will focus on refining postprocedural care in rats and mice.

Postprocedural care begins during the planning stage of an animal study proposal. This is important in establishing that the institution is adequately staffed and stocked to provide timely and appropriate intervention. This chapter describes the modern methodology that enables biomedical research programs to attain a high level of animal care and research support for commonly used research animals.

II. RECRUITMENT AND ORGANIZATION OF SPACE

For early postprocedural animal patients, provisions for appropriate monitoring equipment, space, and personnel are more easily accomplished in a centralized location. Cages should be located so that the animals are easily monitored and changed at frequent periods. Records, which may require frequent entries, are best located close to the patient so that all personnel charged with the provision of care and research support have a central repository of information at their fingertips. This section provides species-specific tips for rodents as well as emphasizes important provisions that are considered routine and ordinary in large-animal care settings.

A. Rats and Mice

The postprocedural area should be warm and quiet with limited pedestrian traffic. Lighting should reflect the day/night light cycle that is appropriate for the species (Commission on Life Sciences, 1996b).

The acoustic environment rarely receives attention other than trying to separate noisy areas (cage wash, barking dogs, etc.) from quieter areas (surgery, rodent animal holding rooms, procedure rooms). However, because rodents hear high-frequency sounds that are undetected by humans, the acoustic environment presents a potentially confounding impact on the physiology of the animal. The impact is influenced not only by species but also by strain, extent of exposure, and characteristics of the auditory stimulus (intensity, familiarity, duration; Turner et al., 2005). Multiple physiological systems have been affected by nonauditory acoustic signals including disturbances in the circadian rhythm sleep cycle and changes in endocrine and cardiovascular

function. Electronic equipment, the building HVAC system, and opening and closing doors are examples of nonauditory acoustical noise that may confound postprocedural assessment of the animal.

In a similar manner, the light spectrum perceived by rats and mice compared to man are dissimilar. Rats and mice, unlike man, possess ultraviolet photoreception. Studies have demonstrated that UV wavelength can influence neuroendocrine and behavioral responses (Brainard et al., 1994). The spectral sensitivity of the rat and mouse retina, composed primarily of rods, suggests that they are unable to see in the red light wavelength. However, Hofstetter unexpectedly discovered that a dim red light-emitting (1 lux at 652 nm) diode (LED), which was activated with activity, increased the circadian pattern of common strains of mice used in biomedical research (Hofstetter et al., 2005). Fluorescent lights from monitors, computer screens, etc. are frequently found in intensive care units (ICUs) and can unintentionally affect an animal both physiologically and behaviorally. A system must be developed to ensure that the lights in the recovery area, if not in an animal holding room, go on and off at the normal times of a day typical for the vivarium.

Thus, creating a centralized rodent support area is the most efficient approach to providing this environment for the first 24–72 hours postoperatively or at least until the attending veterinarian has determined that normal vital signs and/or clinical endpoints are established. This is especially important if the procedure requires entering a major body cavity, is prolonged (>1 hour), or causes major disability. If space is not available for creation of a central support area, well-stocked mobile carts are handy tools for visiting animal holding rooms to monitor animals. This is especially useful in minimizing inefficiencies associated with travel back and forth to procedure rooms for necessary supplies. Mobile treatment carts should be stocked with the necessary supplies for basic veterinary nursing care (thermometers, fluids, supplemental forms of nutrition, hard or soft records such as palm pilots, laptops, or index cards) (Hampshire and Davis, 2000a).

Public Health Service Policy espouses the use of methods to control pain and distress when procedures are expected to cause more than momentary discomfort (Commission on Life Sciences, 1996a). Occasionally, the postprocedural period requires clinical intervention and may cause discomfort. For this, a small mobile anesthesia unit is useful. Additionally, if frequent blood sampling is required, the rapid induction and recovery of animals with a general anesthetic may be preferable to hand restraint in order to minimize sampling trauma. A tabletop isoflurane unit with a self-scavenging device, tubing, charcoal canisters, and an induction chamber can also be installed on the mobile cart. Finally, a support area should be well stocked with sterile, small surgery packs and/or cold sterilant for nonsterile instruments. The area should have a sink for cleaning dirty instruments and ideally a small ultrasonic instrument cleaner and a tabletop autoclave.

1. Primary Enclosures: Rats and Mice

a. Single versus group housing

It is preferable to isolate individual rodents during the immediate postprocedural period in order to improve individual observations, enhance the quality of clinical assessments, and more easily provide individual intervention and treatment. Individual housing will also minimize chewing by conspecifics on sutures and staples and the incidence of injury due to disorientation in the immediate postprocedural course. If this is not possible, limiting the number of animals per cage should be considered.

b. Bedding

In the postprocedural period of rodents, bedding will often adhere to the incision line, which delays wound healing. Frequently during the first 72 hours of postoperative care, when animals are receiving fluid therapy, the cage bedding can also be urine-soaked. Standard rodent bedding may mask seepage from the incision line which, when crusted with serosanguinous fluid, can hamper mobility. Thus, another stocking item to consider is appropriate change-out cages with bedding or Iso-PAD™ (Omni BioResources, Inc., Cherry Hill, NJ) and water bottles. Iso-PADs absorb fluids and allow visual inspection for evidence of urine, blood, and wound seepage. They absorb moisture better and caregivers can easily assess the quality and quantity of the waste material. The pads also provide sufficient traction to aid ambulatory efforts of weakened (muscular) or impaired (peripheral nerve injury) animals.

c. Cage accessories

Various authors have described the benefits of cage enrichment for rodents Gonder and Laber, 2007; Moons et al., 2004; Smith and Corrow, 2005; Van de Weerd et al., 1997). Recently others have described interspecies and interstrain differences in the response to various enrichments that may effect experimental outcome (Tsai et al., 2002). This view was later countered (Wolfer et al., 2004). Olsson and colleagues performed a series of 40 studies over nearly 20 years and determined that mice will work for an enriched cage (Olsson and Dahlborn, 2002). Thus, for improving animal welfare immediately after procedural stress, this is a topic that should be addressed by the animal program.

Burrowing is a particularly important activity to try to supplement when pads are preferable to thick paper or shaved wood bedding. A large paper tube stuffed with shredded bedding still provides suitable opportunity for hiding and nesting (Fig. 9-1). In addition to the option for a cardboard tube, the authors also use paper towels or cotton nestlets as a substrate for burrowing (Hampshire and Davis, 2000a).

Additional concerns regarding housing practices for the postprocedural period of rodent studies are the use of automatic



Fig. 9-1 An example of a cage suited for a postoperative rat. Absorbent bedding provides clean visible surfaces for assessing bowel and bladder activity while a cardboard tube provides opportunity for hiding and burrowing. Food treats can also be kept clean and inspected for patient appetite. Note that the cages are placed on a warm water circulating blanket; fluids with analgesic are also kept warm by placing on the warm water circulating blanket. The green postoperative monitoring card is clearly visible.

watering devices and animal studies involving the insertion of head implants. For the former, special arrangements may be needed for water bottles, gel packs, or other water sources until the animals are returned to their home rack. For animals with head implants, animals in metabolic caging, or other customized protocol-specific cage design, prior planning should address specialized cage needs. The type of implant may also preclude the use of nesting material or paper tubes in the cages, thereby requiring more imaginative environmental enrichment.

B. Large-Animal Postprocedural Housing

A proper functioning large-animal postprocedural unit should be able to accommodate all of the species used in the facility, including rabbits, small ungulates, and dogs, with considerations for separation of species using visual, olfactory, auditory, and/or climatic barriers. This can be achieved using temporary or permanent walls, secondary enclosures, mobile dividers, or as a last resort, curtains.

Most programs have requirements to house animal biosafety level 2 and/or 3 projects. Some may also require boundaries for radioactively labeled animals. Since these needs compete for available space for research needs, the selection of isolated rooms for individual species is sometimes not realistic; however, the centralized intensive care area as discussed in this chapter will work nicely for most research projects and it may be duplicated in smaller care areas for large animals and ABL2 and ABL3 projects or particular projects where animal noise is expected.

Little has been written about the impact of noise on large-animal welfare. Generally the potential impact of vocalization by large-animal patients is a rationale for the separation of species. Large animals are also known to require adequate lighting and decreased sensory stimuli to obtain normal sleep patterns (Lucas et al., 1977). A disruption in lighting and sleep patterns in large-scale shelter operations was noted to cause an increased frequency of dog bites, which was dramatically reduced by establishing dark quiet periods of shelter inactivity (Hampshire, 2005).

Generally speaking, when most large-animal species become alert and noisy, they have likely surpassed the goal of the post-procedural care unit and belong most appropriately to an interim care area where observation and care is provided at a reduced frequency. Ideally, this intermediate care area is an area of the animal facility that is easily accessible and close to the veterinary and technician offices, such as a room between the intensive care area and laboratories, or the animal's home cage that can be easily visited with supplies on a mobile cart.

Polyvinyl-coated raised flooring has become the standard in primary and secondary enclosures for large research animals. It is recommended that these animals be kept in caging that permits easy access to intravenous (IV) ports, ready spot cleaning, and ergonomically thoughtful arrangement of animal versus floor. IV line swivel systems keep fluid lines out of urine and feces. Wall-mounted food and water receptacles should be acquired for stationary or transport cages. Hay nets can be used to achieve upright head positions for sheep. Likewise, dogs and swine that are instrumented with Elizabethan collars, swivel systems, or jackets may benefit from the use of portable ball-valve bottles or raised pans (Fig. 9-2).

C. Cabinets and Ancillary Equipment

Most contemporary programs have configured the post-procedural space for large research animals in much the same way that a veterinary teaching institution might approach the requirement. Desirable attributes are ease of cage and cabinet movement, occupational safety and health, ease of sanitation, elimination of clutter, and ability to easily hang various fluids, monitors, and pumps. The postprocedural space is also ideally located close to the surgical and radiology area and should permit easy access to attending veterinarian and key technical offices, laundry facilities, and records.

The ideal arrangement of caging and resources utilizes ample and flexible lighting, sanitizable surfaces, mobile countertops (Fig. 9-3), mobile oxygen cages, piped oxygen (as opposed to tanks), portable IV pumps mounted on IV stands, portable drawer units, and a few sanitizable stools for staff to seek postural relief. Floor drains are also especially helpful in large-animal intensive care settings so that cages can be easily spot-changed. The value of a waist-level tub cannot be overemphasized in order to provide hand sanitization of food and water bowls, give a



Fig. 9-2 A swine cardiovascular model is instrumented with telemetry for purposes of monitoring heart rate and rhythm. Note that the carboy mounted atop the temporary transport cage facilitates no-spill easy provision of potable water. Picture courtesy of the National Institutes of Health Veterinary Resources Program.



Fig. 9-3 An example of a stainless steel cabinetry used in the large-animal postprocedural care unit. The cabinet is manufactured with stainless steel casters for ease of maintaining sanitation. (Courtesy of the National Institutes of Health Veterinary Resources Program.)

quick bath to the recovering animals, or clean rubber cage mats. Such organization also permits reorganization of space and barriers with little to no programmatic cost or effort. Surfaces and mobile carts should also be ample enough to accommodate necessary veterinary supplies, computerized or paper records, critical care diagnostic equipment, and refrigeration and incubation of key fluids and/or drugs and specimens.

1. *Stocking Supplies*

a. Rats and mice

Working solutions of fluids should be dated. Stock preparations should include 250 mL bags of normal saline or lactated Ringer's solution maintained in a fluid-warming unit. Preformulated bags of nonsteroidals and opioids in 250-mL bags are helpful for rapid delivery of fluids and analgesics to large groups of recovering rodents (Hampshire and Davis, 2000b).

A selection of small-gauge syringes and needles, butterfly needles, and gavage tubes, various types of disposable wipes including disposable diapers, lab bench absorbent pads, paper towels, and utility wipes should be stocked, plus 2 × 2 in. and 4 × 4 in. gauze squares and cotton-tipped applicator sticks. A few packets of suture and stainless steel wound clips should also be stocked. A small digital scale (electric or battery-operated) is required. The scale should be capable of accurately weighing both mice and rats if both species are used at the institution.

Petroleum-based artificial tear ointment, lubricant jelly, and a topical analgesic crème or ointment [EMLA[®] Crème (2.5% lidocaine + 2.5% prilocaine), AstraZeneca, Wilmington, DE] are additional medications often needed. Doses of commonly utilized antibiotics, anesthetics, and analgesics are available in the literature. Internet-accessible dose formularies and pocket editions of formularies from almost every large university animal program also exist (Adamcack and Otten, 2000; Atinoff, 1998; Dartmouth University, 2007; Heard, 2000; Marx and Raston, 2007; Plumb, 2002; University of Pittsburgh, 2007).

b. Large animals

The postprocedural care ward is a place where rapid, efficient assessment and humane intervention is necessary. The veterinary marketplace now contains a number of vendors who market small, easily calibrated, and even handheld diagnostic devices with cartridges for rapid assessment of various chemistry panels. For any diagnostic equipment in the postprocedural care setting we recommend routine maintenance programs.

Supplies that are used frequently should be in visible bins or well-marked drawers. Unnecessary or infrequently utilized equipment should not be occupying horizontal space surfaces. Emergency equipment such as electrocardiogram (ECG) monitors and defibrillators should be located on an easily accessible lightweight crash cart along with an intubation equipment. The countertops should contain the basic diagnostic equipment that permits rapid assessment of hemodynamic and physiologic variables. Standard operating procedures (SOPs) should be in place and training records should indicate that each employee who may come upon an animal in need of cardiopulmonary resuscitation can both recognize that it is in such a state and respond accordingly using all equipment that is on the cart.

Drawers should contain drawer-separators to ensure that supplies are easily located. Drawers should be appropriately labeled

TABLE 9-1

CHECKLIST OF POSTPROCEDURAL CARE EQUIPMENT FOR FLOOR, COUNTERTOP, OR OPEN-SHELVED ITEMS

Hematocrit centrifuge, hematocrit tube putty, and heparinized hematocrit tubes and putty
Refractometer
Complete blood count machine
Portable gas anesthetic unit
Intravenous fluid pumps mounted on stands
Microscope and slides, staining solutions such as Diff Quick ^a
Cage-side or handheld electrolyte analyzer (cartridge variety)
Glucometer
ECG machine
Blood pressure monitor or Doppler blood pressure monitor
Nebulizer
Apnea monitors
Activated clotting time capability; either gray-top tubes or analyzer (now available)
Stethoscope
Otoscope
Ophthalmoscope

^aMany vendors sell this stain under a variety of commercial names. DiffQuick is a three-pack of methanol fixative, buffered eosin, and phosphate buffered Azure B.

so that all users are aware of what devices are contained within. We recommend a checklist of postprocedural care equipment or open-shelved items as shown in Table 9-1.

III. STAFFING AND PERSONNEL

Adequate care of recovering animals involves the systematic utilization of veterinary physical examination skills. Such skills involve the interpretation of clinical findings (within the context of the animal model) with diagnostic results; the ability to document such findings in order to create an efficient and harmonious functional postprocedural care unit, an intuition that helps advise the principal investigator and his/her staff regarding confounders or enhancements to the protocol; and the wisdom to be able to integrate the findings into one or more standardized outcomes that result in best science, optimal animal wellness, and programmatic compliance. Ideally, the postprocedural function of an animal program is structured in such a way that one or more highly experienced attending veterinarians supervise a team of qualified technologists and works on a daily basis with the investigative staff. Although this type of animal care paradigm is rather common for the large-animal setting, it is not the typical practice in a high-density rodent facility. Nonetheless, programs should strive to provide this level of effort for rodents as well as large animals. The authors have described tangible and intangible savings associated with enhanced stewardship of rodent postprocedural care in such a paradigm in a previous paper (Hampshire and Davis, 2000b).

TABLE 9-2
QUESTION AND ACTION LIST FOR POSTPROCEDURAL PLANNING

Question	Action
Has the procedure been done in humans or other animal models?	If yes, describe the level and duration of pain and recovery period.
What physiologic impact is anticipated?	Example: cardiovascular, neurologic, gastrointestinal, etc.
What are the supplies necessary for recovery (antibiotics, analgesics, bandaging, etc.)?	List necessary supplies.
Are there any drugs or procedures that are known to confound the research plan?	List drugs or procedures that might confound the experiment.
Do you envision any bleeding complications?	If yes, be certain to have donors identified, and/or blood and blood components on hand.
Will the surgery be prolonged (>1 hour)?	If yes, plan for prolonged observation and possible hypothermia.
How long will it be until the animal will eat?	If yes or not sure, plan for fluid therapy or total parenteral nutrition and prolonged venous access. (If rodent, consider acquiring a model with jugular access.) ^a
Will it be nauseated?	
Will the investigative staff be present to help with recovery?	If yes, schedule training and orientation with investigators. If no, identify animal program staff necessary to support the model.
What will the likely clinical endpoints be for discharge from the ICU?	Identify action items to result in successful discharge to interim or routine housing.

^aSome rodent vendors will sell rats with indwelling jugular access.

IV. OVERSIGHT, PLANNING, AND ORGANIZATION

Title 9 C.F.R., Section 2.33 of the Animal Welfare Act describes the regulatory requirements of adequate veterinary care, including a period of consulting in advance of initiating the protocol (Title 9, 1985). Animal care programs apply these regulations and principles to all species in an effort to meet Public Health Service (PHS) and Association for the Assessment and Accreditation of Laboratory Animal Care (AAALAC) International standards and to better control the experiment.

A. Assessing the Model; Determining the Interventions and Endpoints

The animal model and the type of procedure will guide the selection of anesthesia, analgesia, and supportive care during recovery. The postprocedural period of animal care is a period of high metabolic demand where research personnel must monitor for pain and distress, as well as physiologic and pharmacologic stability. Animals are fragile during this period. Common risks include hypoxia, hemorrhage, fluid and electrolyte depletion, and infection (Langlois, 2004).

Programmatic planning should include a prediction of the level of distress and/or pain that is expected based on what is known about other animal models or the human condition. For example, a protocol involving a high intensity and low frequency of expected pain may only require high levels of analgesia and frequent monitoring for a few days versus a model that might cause physical or physiological impairment for weeks or

months. An investigator interview checklist and action items format is helpful for this purpose (Table 9-2).

1. *Familiarity with the Experimental Model*

The consultative period required under present research regulations and standards and the literature search required under the Animal Welfare Act (Title 9, USC 1985 [AWA]) are key opportunities for animal care staff to explain to the members of the investigative team why the control of pain and distress in the perioperative period not only is beneficial to the animals' well-being, but also reduces experimental variability from a host of physiologic and behavioral confounders associated with adverse homeostatic parameters. Although the search for alternatives required under Section 2.31 of the AWA was intended to provide information about alternatives to the use of animals, it is also an excellent way to find literature about what might be known about supporting the proposed research condition in humans and how this information might be applied to a veterinary patient.

2. *Knowledge of Background Characteristics*

Other contributing factors to postprocedural planning and consideration are health status, age, strain and substrain, and animal position during surgery or procedure. For example, pregnant animals and ruminants frequently do not have adequate tidal volume due to pressure on the diaphragm whereas older animals may have inadequate gas exchange despite a relatively normal tidal volume and respiratory rate. Geriatric animals that are anesthetized and breathing room air are more prone to hypoxemia than young animals. (Note that age ranges vary with strains of rat and mice; R111 mice, for example, typically

live no longer than 8–10 months.) The popularity of genetically engineered rodents (GEM) may pose significant factors for consideration both prior to the procedure and during post-procedural care. Physical conditions of GEM animals may alter anesthesia regimens. For example, mice with induced peripheral neuropathies may have problems with respiratory function. Muscle weakness associated with these conditions reduces functional residual capacity and suppresses alveolar ventilation. An additional variable is that surgery involving rodents usually means a relatively large group of rodents will have surgery in a single day.

Strains of rats or mice can also vary significantly in their normal clinical values. For example, blood urea nitrogen (BUN) has a range of 19 ± 2.2 mg/dL in male Sprague-Dawley rats but in Fisher 344 male rats it is 15 ± 2.5 mg/dL (Fox et al., 2002). It may prove difficult to find normal values for a particular stock or strain of rodent, and genetically engineered animals present additional challenges; in this case, clinical pathology values for a common rat or mouse strain should be used as a guideline until acceptable clinical values (through experience) with the particular animal stock or strain are established. Other physiological parameters such as thermoregulation and hydration are more easily assessed and controlled.

Thus, the more the information gathered about the model, the greater the potential for providing outstanding veterinary care and support.

3. *Expected Duration and Intensity of Pain or Distress*

Each model and each procedural approach share basic similarities due to similar responses to anesthesia, surgery, and/or procedural stress. However, there are also unique aspects to consider such as the degree of pain involved, if physiological impairment is induced (ataxia, toxic injury, etc.), and the length of time the animals are expected to survive prior to reaching the experimental endpoint. The species, strain, and gender of the animal; the skill of the investigator; and the skill of the persons responsible for providing postoperative care influence all these factors.

In order to standardize observations, a scoring assessment chart is helpful (Peterson, 2004; Stasiak et al., 2003). If there is no precedent for the procedure or the proposed interventions in question, a small pilot study may also be indicated. For example, Roughan and Flecknell (2001) observed groups of rats pre-surgically and post-procedurally, with and without analgesics to identify behaviors that could, through statistical analysis, be used as indicators of pain or discomfort. Sixteen behaviors were identified by discriminant analysis and four of these behaviors (“cat-like” back arching, horizontal stretching, writhing, and twitching while inactive) were found to be markedly reduced (thereby quantifiable) and therefore of practical value when determining the efficacy of an analgesic in the rat for the procedure performed. Based on these findings, it was suggested that pilot studies be performed initially to determine

how the drug might alter behavior in a manipulated animal. It has also been noted that such efforts are often added attributes for presentation in research publications, which were not necessarily deemed of use in advance of the research (Morton et al., 2001).

4. *Establishing Criteria for Intervention*

Following the review of the literature, the development of a working understanding of the duration and intensity of distress and/or pain associated with the protocol, and gathering of knowledge of background characteristics, the research team is in a better position to identify clinical parameters (such as body temperature, blood pressure, body mass index, tumor size, activity level, appetite, hydration) that can be monitored by the veterinary staff without compromising the scientific endpoint.

Establishing a clinical endpoint is critical to assuring animal well-being, by avoiding prolonged delay when the animal is obviously not recovering or is moribund. Clinical and/or humane endpoints such as appetite, weight, hydration, hemogram values, and level of pain should be clearly distinguished from experimental endpoints, and the investigator needs to understand that the former may be reached well in advance of the latter.

5. *Training Requirements*

During discussion with the research team, the veterinarian also has the opportunity to explore how well the investigators understand and recognize normal animal behavior and demonstrate the ability to detect subtle signs of pain and distress. If it is clear that the investigators have relatively little experience differentiating normal from abnormal behavior, they may be receptive to the idea of a small pilot study, with significant participation of a clinical veterinarian, to hone their observational skills and customize training. This is especially true if the staff has no experience with the animal model or if the investigator is having difficulty developing appropriate monitoring plans and intervention charts.

B. Institutional Animal Care and Use Committee Approval

Once a model has been selected and the approximate level of effort has been defined, the institutional animal care committee is better able to participate in an informed decision about whether the postprocedural care of the animal model is appropriate and whether the institution can allocate the personnel and resources to meet adequate levels of care. The IACUC must recognize that complete monitoring plans, including identification of individuals responsible for monitoring and their contact information, are in effect before a study is approved even if this means a delay while hiring additional personnel. The IACUC

must also be prepared to insist that monitoring and assessment plans proposed by the investigator are adequate. Without the support and participation of IACUC, it is difficult to convince reluctant investigators about the beneficial effects of these plans.

C. Scheduling

Some animal programs have adopted several policies that prove beneficial for both the animals and staff. First and foremost, it is advisable to limit procedural insults such as surgery or key injections to Monday–Wednesday, e.g., not on Thursday or Friday. The reason for this suggestion is that the first 72 hours postoperatively are usually the most critical time for the animals. Veterinary patients who have surgery early on Monday or Tuesday derive the benefit of a full staff for support care during this critical time period; those who have surgery on Wednesday benefit from 48 hours of full staff for support. Weekend staff should be fully aware of concerns or special instructions for the animals over the weekend. Similarly, other research procedures that may affect the animals' well-being (complete Freund's; infectious agents; LPS, streptozotocin, or cyclosporin administration) require the same focus.

V. MONITORING AND INTERVENTION

A. Personnel and Shifts

A combination of veterinary and investigator staff is generally required in order to meet programmatic goals for timely veterinary care. For veterinary technical support, one option is to extend shifts or have overlapping shifts of personnel in order to provide late postoperative monitoring and dosing of analgesics, fluids, and antibiotics as well as to ensure the animal is warm and comfortable (bedding is not wet) in its home cage. Having personnel work in shifts provides greater flexibility in frequency of dosing drugs as well as in monitoring of the animals. If two or more clinical veterinarians are available this concept extends to them, as well. A veterinarian performing late treatments can address potential problems before they become critical or life threatening. Similarly, use of the scientific group will augment the monitoring and treatment schedule as well as provide the scientist with a complete perspective of the requirements of the animal model.

B. Acclimation and Baseline Assessments

Animals destined for surgery or procedures should be identified well in advance, to allow time (conditioning phase) for staff to observe the animals prior to the procedure, handle them and introduce the caging and nutritional supplements that are planned during the postprocedural period. During this

time a baseline weight and an appreciation of normal posture and nature (friendly, inquisitive, anxious, aggressive) can be obtained and normal hematologic, hemodynamic, and serum chemistries can be established. Staff will learn the individual personalities of the animals that will make their observations and assessments more powerful. Tickling in adolescent rats, for example, is known to produce a positive social affect, which can be induced by technician(s) who will be giving postoperative injections if they begin to play and tickle the rats before surgery (personal experiences; Panksepp, 2005, 2007). Dogs and swine are exceptionally responsive to human handling and treats, and can be socialized using combinations of food treats and play to acclimate them in their new environment.

C. Trending Criteria

One of the most critical decisions to make during the periprocedural period is what the best frequency of observation will be to minimize distress and optimize scientific study. Another important concept is that despite the best planning, trending frequencies may indicate deviation from the plans and so staff should remain flexible and treat based on the trend shown by the patient rather than that developed in the plan.

Rechecks for large and small research animals are best scheduled at a frequency determined by the attending veterinary staff, depending on the animals' status at the last recheck. This will likely vary among animals in the same protocol, because some interanimal variability is inevitable.

Monitoring techniques differ between large-animal species and rodents. Generally speaking, large-animal models lend themselves to better arterial and venous access and more detailed monitoring that enable better objective assessment of hemostatic and infectious processes, better control of hydration and cardiovascular support, and ability to control pain. This ability lends a greater level of confidence in reducing monitoring intervals. Whenever more than a few days of illness is expected, or sampling of blood is required at frequent intervals, vascular access ports should be considered. Swindle et al. (2005) have detailed chronic intravascular access port placement and care. This practice also permits the administration of larger molecular weight colloids and/or total parenteral nutrition (TPN), a mainstay for protocols with predictably long periods of anorexia such as those involving alterations in major organ function or sepsis (Natanson, 1990; Pennington et al., 1988).

Large-animal observations should include a minimum subjective data set of appetite, thirst, urination, defecation attitude, and condition of hair or skin coat. Cage-side equipment (Table 9-1) should permit a minimum assessment of respiratory rate and character, mucous membrane color and refill time, heart rate and rhythm and pulse character, packed cell volume, and total solids, serum electrolytes, and blood glucose.

The appropriate monitoring of rodent patients is often more challenging because it is often a more subjective assessment.



Fig. 9-4 The removal of a cage lid permits the observation of the patient's curiosity, postural adjustments, strength, and agility.

Modern care paradigms have advocated a combination of subjective and objective measures into a composite scoring system. Objective indices may be added to the subjective components (Flecknell and Liles, 1991; Morton, 2000). These indices may include attributes such as body weight, locomotion, gait, urine specific gravity, hematocrit and packed cell volume, body temperature, and any other objective measures that may be protocol specific and measurable in rodents. A range of numerical scores is determined for each attribute and a low and high possible composite score determines the degree of intervention (Hampshire, 2001; Hampshire and Davis, 2000a; Morton, 2000; Smith et al., 2006). A number of excellent web-based training resources and tutorials are now available to illustrate subjective and objective assessment of laboratory animals (American Association of Laboratory Animal Science, 2007; University of Edinburgh, 2007; University of Newcastle, 2005). Observing animals from a distance is also important in order to eliminate confounders introduced by apprehension or excitement. Removing the cage lid and observing from a distance offers more information about attributes such as curiosity, gait, and neurologic status (Fig. 9-4).

In the chronic period, the challenge is to avoid relapses in clinical signs. For this, a prospective re-evaluation system is recommended. For rodents, those cases that raise reservations or concerns about possible relapse can be flagged in the holding room with cage card tags indicating weekly, biweekly, or monthly rechecks for possible relapse (Fig. 9-5) (Hampshire and Davis, 2000b). For large research animals in cages or pens, a computerized database with calendar reminders is helpful in recalling the patient for re-examination.

1. Thermoregulation

The control of normal body temperature is a fundamental activity in most postprocedural programs of support.



Fig. 9-5 Mouse cages in which cage cards are conspicuously different in color and contain flags for repeat evaluation. These flags have a corresponding index card as a medical record, which is kept in a wall-desk outside the room or in an index card box specifically for rechecks organized by month and week in the central treatment room.

Hypothermia is one of the most preventable postprocedural conditions, and efforts to intervene to prevent extremes in body temperature can result in preventing other sequelae such as overutilization of glucose, cardiac depression, and hypotension.

a. Rodents

All fluids should be warmed to body temperature before administration. Placing cages on recirculating warm water blankets, using heat lamps (at a safe distance from the animal), and placing insulated hand warmers (Warm Buddies[™] 'N Pals[™], Heat Factory Inc, Vista, CA) in the cage are all effective means for providing external warmth. Alternatively, forced warm air (Arizant Bair Hugger Model 750) or a heater (Heater Module 760100, Small Animal Instruments) can be used. If cages are placed on a recirculating warm water blanket, two tips should be remembered: (1) the blanket should not be set at a temperature $>37^{\circ}\text{C}$ (100°F) or the animal may develop hyperthermia and (2) the cage should be placed half on the blanket, which allows the animal to self-regulate their environmental temperature, moving from warmth to cool, as needed. If heat lamps are used they must be placed at sufficient height to preclude unintended burns. This rule also applies during surgery. It is not unusual to note burned ears (pinna), nose, or eyes (corneal lesions), caused by strong surgical lights trained on the incision area without adequate protection of the sensitive tissues (drapes, ophthalmic ointment, etc.). These iatrogenic injuries not only are unfortunate, causing unnecessary harm to the animals, but also may further impede the animal's recovery. Other causes of iatrogenic burns include inadequate grounding of cautery equipment and injection of low/high-pH substances.

b. Large animals

The physiologic effects of anesthesia are pronounced and the subject of thermostasis has been an area of active investigation by nurses, anesthesiologists, and critical care physicians (Cooper, 2006; Fossum et al., 2001; Frank et al., 1995; Giesbrecht et al., 1994; Lee et al., 2004; Patel et al., 1996; Vanni et al., 2003; Wilson et al., 2006). Beneficial strategies may be undermined when body temperatures are not maintained. For example, Wilson et al. (2006) reported that the isoflurane minimum alveolar concentration (MAC)-sparing effects of transdermal fentanyl normally seen in warmed dogs are absent in hypothermic dogs. This finding has also been duplicated in the pig model (Satas et al., 1996).

A modern laboratory postprocedural care program institutes preemptive measures such as preanesthetic warming, intraoperative forced warm air, and warmed fluids as well as postprocedural monitoring and provisions for maintaining thermoneutrality. Common confounders to the approach of maintaining thermoneutral systems in research animals include the use of cold aluminum transport cages, the staging of animals in hallways or corridors that are not appropriately warmed, delays in moving animals from a warm operating room to the postprocedural care unit, and inadequate frequency of monitoring or efforts at provisional thermal controls.

Thus, SOPs should be developed in consultation with surgical personnel to address the holding of animals during the preanesthetic period in prewarmed chambers, the utilization of incubators to maintain reserve fluids at body temperature, the acquisition of IV pumps with fluid warming capacity, and the use of forced warm air above and below the patient while in the postprocedural care unit and in transport if possible. Hyperthermia is also a rare possibility, well documented for outbred research swine (Denborough, 1998). Managers should have a ready source of crushed ice, chilled blankets, and a stock of dantrolene for this less likely possibility.

The subacute, intermediate, and subchronic periods of postprocedural management should also involve planning to monitor temperature. During these periods, hyperthermia either from inflammation or infection, or of CNS origin (common in stroke models) is more often a concern; however, certain models also may be prone to hypothermia. For example, a pancreatized model may develop secondary chilling due to the inability to adequately utilize glucose.

2. *Cardiopulmonary Support, Hemodynamics, and Acid/Base Balance*

To the extent that instrumentation permits, cardiac and respiratory parameters should be recorded and their irregularities corrected. Uncontrolled cardiac electrical activity can lead to poor perfusion and death. Catecholamines enhance influx of sodium and calcium, which increases the risk of arrhythmogenic effects via increased amplitude of after-potential and

nonuniform repolarization of the myocardium. Reperfusion following recovery from hypovolemic shock may also cause myocardial necrosis and arrhythmias (Podrid et al., 1990). There are many additional examples of injury, intentional or spontaneous, that indirectly place the heart at risk for arrhythmia development. However, treatment with antiarrhythmogenic drugs is also risky and can result in serious systemic side effects (Hamlin, 1992). Thus, for procedures where there is expected pain and distress, monitoring and control of arrhythmias should be practiced whenever possible.

Monitoring respiratory pattern and blood pH is important especially in the immediate hours following surgery. Anesthetics can cause a reduction in respiratory rate and tidal volume. Painful procedures may also cause decreased chest expansion with secondary tachypnea so that often the correction of acid/base balance can be linked to adequate analgesia. Knowing the anesthetic regimen is also helpful in anticipating potential acid/base problems and in having the means to correct problems encountered due to the anesthetic. Alpha-agonists (medetomidine) are popular drugs used in combination with ketamine for many rodent procedures. However, the animal often remains sedated when under the influence of alpha-agonists, which puts them at risk for hypothermia, bradycardia, hyperglycemia, and respiratory depression.

The airway should be assessed at appropriate intervals to characterize normal rate, depth, and sound of breathing. In the acute perioperative period, additional atropine should be considered for research animals that demonstrate excessive mucus production. Provision of oxygen during the first few hours of recovery may also be beneficial to recovering laboratory animals. For this purpose, a small Plexiglas pediatric unit might be a worthwhile addition to rodent recovery areas.

Monitoring arterial blood gases and pH in large-animal research subjects will provide early indications of an acid/base abnormality and thus indicate the degree of intervention necessary. Historically, with respect to rodent models, this was difficult to accomplish due to the sample size required. Instrumentation is now available for this purpose (Radiometer ABL77, Radiometer America). This instrument will measure pO_2 , CO_2 , phosphorus, sodium, potassium, chloride, and calcium on sample sizes as small as 70 μ L.

Anesthesia and surgery in large research animals can also produce shifts in acid/base status due to prolonged abnormal positions, decreased muscle tone, decreased chest expansion, hemorrhage, decreased cardiac output, decreased renal perfusion, and increased catabolic demand (Clavijo-Alvarez et al., 2005; Sims et al., 2001). These shifts are often dependent on duration and intensity of invasiveness and on the expected experimental outcome. Key monitoring schemes involve rapid assessment capability using small-volume repeat arterial sampling (capillary tubes are ideal) for acid/base, blood glucose, and electrolytes (sodium, potassium, chloride, calcium), and total carbon dioxide measurement. Handheld and tabletop units are available. For ease of use, we recommend handheld versions

with small-volume sample cartridge capability unless the program is performing large numbers of procedures and is capable of calibrating in-house equipment daily (IDEXX Laboratories).

Hypotension can be a sign of hemorrhage, endocrine disruption, pain, and decreased cardiac output. Efforts to track and control blood pressure are mainstays of a sound postprocedural care facility.

Telemetry is extraordinarily helpful for tracking key patient variables and for detecting small differences over baseline characteristics that external cuff and Doppler devices may not read with precision. Telemetry offers a means to monitor blood pressure and electrocardiographic parameters for both rodent and large-animal models. However due to the high equipment costs and high heart rates of rodents, telemetry is not commonly utilized for postprocedural monitoring, nor are attempts to intervene common. Some large-scale highly funded rodent facilities such as a dedicated rodent imaging facility or a large-scale physiologic monitoring program may utilize this type of technology. Another example might include drug discovery wherein the large-scale monitoring of individual rodent research subjects for changes in hemodynamic variables is desirable.

State-of-the-art large-animal cardiovascular-targeted research programs have shifted to the use of indwelling arterial lines or telemetry devices in order to adequately and accurately monitor blood pressure and heart rate (Ilback and Stalhandske, 2003; Miyazaki et al., 2002; Najafi and Ludomirsky, 2004; Soloviev et al., 2006). Some telemetry devices are enabled with temperature and ECG capability. Again, due to the expense and the need for single housing, these systems are not in general use in routine recovery areas across most biomedical research institutions. In most postprocedural care areas, blood pressure is still measured by external cuff or Doppler device and heart rhythm and rate by stethoscope and/or ECG.

3. Hemostasis

Bleeding can be a common complication from experimental research procedures. An ICU and/or postprocedural care routine should have adequate diagnostic equipment and methods for monitoring packed cell volume (a hematocrit centrifuge, tubes, and putty). Blood loss, when detected early, can often be mitigated, either through surgical intervention or through transfusion. Intervention by transfusion is usually a procedure performed in large-animal research models and requires careful attention to species-specific blood types, blood storage requirements, and rules of administration to avoid inadvertent embolisms.

4. Hydration and Electrolyte Balance

The provision of adequate hydration and the restoration of normal tissue volume may be the most important interventions in the postprocedural period. This effort also supports normal

renal and cardiac function as well as the distribution and elimination of necessary antibiotics, analgesics, and other experimental treatments. The last decade has witnessed a plethora of references pertaining to fluid therapy. A variety of crystalloids and colloids as well as improved filtration and administration systems for small-volume infusions are available now. The subject of the restoration of blood volume in animal patients has previously been addressed in general terms (Haskins, 1997). Those principles and methods are still appropriate and are slightly expanded in this discussion for the purpose of addressing the special needs of research in rodents.

The recognition of the need to adequately hydrate rodent patients has stemmed largely from work in exotic animal medicine and biomedical research support programs (Atinoff, 1998; Heard, 2000; Waynforth and Flecknell, 1992). A large body of information in companion animal medicine, where dogs vary in size from 1 to 70 kg, also contributes to the large body of literature on hydration requirements. This information has repeatedly emphasized the small size of some research patients, associated with a large body surface area over which body fluid losses can occur. Rats in particular can be research models ranging in size from 200 to 400 g and, at either end of this range, may require different amounts of fluid to sustain adequate fluid volume for homeostasis. A good method for calculating surface area has been published by Hawk and was recently put into use (Hampshire et al., 2001, Hawk and Leary, 1999) (Fig. 9-6a, b). A variety of references recommend similar formulas for establishing weight and hydration-specific doses of crystalloid fluid preparations for rodents (Battaglia, 2001; Kirk et al., 1990; Mathews, 1998, 2006; Schaer, 1998). The range varies from 20 mL/(kg h) for maintenance needs to 100 mL/(kg h) for severe dehydration and/or replacement volume.

Haskins' recommendations for the assessment of hydration by using skin turgor and urine output and concentration are useful for determining an estimated percent fluid loss in rodents and large animals (Haskins, 1997). These methods may be supplemented with the utilization of hematology and serum protein values from a pilot study, the interpretation of a subjective assessment for corneal gloss, or the presence or absence of enophthalmia and concentrated porphyrin stain at the medial canthus. Maintenance volumes are generally estimated between 50 and 60 mL/(kg day) (Kirk et al., 1990; Mathews, 2006) in single or divided doses with higher doses per kg for neonates, pediatric patients, and small rodents based on the formula $1.2-1.3(70 \text{ BW kg})^{0.75}$ (Mathews, 2006). When the interanimal variability in weight in a rodent study falls within 50 g, preparation of individual doses can be minimized by spiking bags of saline or lactated Ringer's solution with the analgesic drug of choice to achieve a final combined fluid volume and analgesic dose that is weight- and species-appropriate (Hampshire and Davis, 2000a). If prepared in advance, a bag can be provided to the surgery team so that they may administer warmed fluids and analgesic simultaneously while closing the incision.

Surface Area to Body Weight Ratios of Commonly Used Research Animals

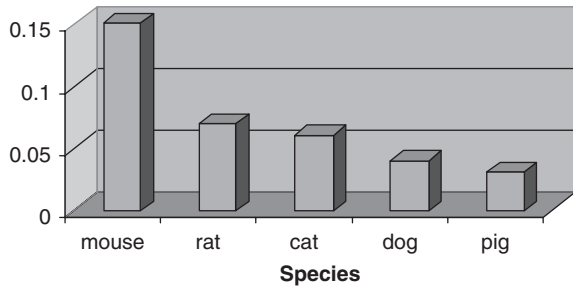

(a)

	kg	mL/day ^a
Mice	0.02	4.5
	0.03	6
	0.04	7.5
Rats	0.2	25
	0.3	34
	0.4	42
Cats	5	280
Small dogs	10	472

(b)

Fig. 9-6 (a) A representative comparison of surface area to body weight ratios of commonly utilized research animals. The formula is $M2 = \text{weight (g)} \times K \times 10^{-4}$, where $K = 10.1$ for dogs, cats, pigs and 10.5 for mice and rats (Hawk, 1999). (b) A representative comparison of fluid requirements in milliliters across the spectrum of laboratory animal weights using the formula: maintenance rate per 24 hour = $1.2 - 1.3(70 \text{ BW kg})^{0.75}$ (Mathews, 2006). ^aDivided in two equal volumes 12 hours apart. The number 1.2 is typically utilized for those animals assessed to be mildly dehydrated and 1.3 for those with moderate-to-severe hydration.

The type of procedure performed may also influence the choice of fluid type to administer. Osmolality, pH, and isotonicity are all important variables for consideration (Haskins, 1997; Morton et al., 2001). Lactated Ringer's solution is a crystalloid replacement fluid that resembles the extracellular fluid compartment and has a pH of 6.5 (considered isotonic). This solution contains 28 mEq/L of lactate, which is converted to bicarbonate in the liver. This exogenous lactate does not affect plasma lactate levels in an animal with normal liver function (Rudloff and Kirby, 1998). Thus, lactated Ringer's solution is beneficial as a replacement therapy for most animals experiencing hypovolemic shock or volume deficits. It is also an excellent choice when an animal is experiencing calcium or potassium deficits. Containing the lactate precursor to bicarbonate, lactated Ringer's solution is an alkalinizing solution and indicated in animals with metabolic acidosis, diarrhea, vomiting, and other metabolic or endocrine disorders. However, scientists should understand that lactated Ringer's solution is not a universal replacement solution. It is contraindicated for use in animals with hypercalcemia, liver disease, or metabolic alkalosis.

The tonicity of blood and extracellular water is 290–310 mOsm/L (Mathews, 1998). The route, rate, and monitoring of fluid administration is important to ensure appropriate volume replacement without fluid overload and its consequences of interstitial and intracellular edema. When dehydration occurs, determining the location of the fluid deficit and calculating volume deficits require a basic knowledge of body fluid dynamics. Veterinarians should be heavily involved in the interventions associated with laboratory animal recovery, especially when fluid deficits occur or are anticipated.

Occasionally, research programs may encounter a model that loses serum protein. Liver transplantation and cardiovascular models of right-sided insufficiency are examples of procedures that are strongly associated with these problems. Colloidal solutions may be considered for these models but should be delivered carefully to avoid pulmonary edema. A variety of products are available commercially for hypovolemia and hypoproteinemia. Most are compounded from high-molecular-weight solutions, including dextran, gelatin, or starch. Different brands vary in their molecular weight and therefore vary in the length of time they remain in the circulatory system. Thus, users should carefully investigate doses in the literature, which rests largely in veterinary nursing manuals (Battaglia, 2001).

IV fluid therapy through cephalic or central lines is the preferred route of choice for small ruminants, research swine, dogs, cats, and rabbits because it permits precise rates of delivery. Indwelling silastic catheters or intravascular access ports have enabled the support of models of severe illness such as sepsis, organ transplant, or toxic shock where morbidity is expected to be pronounced. Swindle and colleagues have described methods for the placement and care of indwelling access catheters (Dennis et al., 1993; Swindle et al., 2005). Fluid rates should be established by veterinary staff and tailored to the patient's physiologic responses, not the protocol. Most fluid rates for large animals can be determined using the formula in Fig. 9-6.

Serum blood glucose can be easily monitored in large and small research animals using simple cage-side glucose monitors and drop-sized quantities of blood. Special problems in glucose management include those animals that have undergone long periods of anorexia, those with infections, and induced models of diabetes or insulinoma. Diabetic models are very commonly encountered and present special management challenges that require strict attention to establishing daily glucose trends (Connally, 2002).

5. Inflammation and Infection

Wound/incision care may or may not be necessary if adequate aseptic technique was practiced during surgery. Many veterinarians are reluctant to administer antibiotics in rodents as a prophylactic measure because of the common adverse effects (enterotoxemia) in many species. Also, mice and rats seem especially robust, possessing admirable resistance to bacterial

infection. This attribute should not be used as an excuse to preclude high surgical standards and veterinary care. Considering the caging environment that confines rodents, a vigilant monitoring and assessment regimen of the surgical incision should be planned and followed. Abdominal incisions and/or wounds are inevitably contaminated with urine, feces, and perhaps bedding. The incision should be cleaned daily and the sutures or surgical wound clips checked to ensure that the animal is not removing them. Rodents that receive cranial implants may or may not require incision care, dependent on the skill and expertise of the surgeon applying the acrylic material. It may be necessary to smooth the edges of the acrylic material with a dermal drill and apply topical antibiotic ointment to the skin/acrylic margin. When the person applying the acrylic is inexperienced, problems may develop because the heat of the acrylic reaction is not controlled (burning the dura and skin) or the acrylic edges are rough, uneven, and/or insufficient. In the latter case, the skin may require sutures to complete closure. If iatrogenic burns occur, bleeding and continued seepage will occur that require both antibiotics and wound care to prevent systemic infection.

Large research animals are best monitored for infection by regular recordings of body temperature and white blood cell count. Various texts exist for reference to normal values; however, comparison to baseline indices and individual laboratory reference normals is emphasized. Antibiotics should be referenced for appropriate dose, route, and frequency (Plumb, 2002), and tailored to conservative treatment of the suspect organisms to avoid the development of resistant nosocomial infections.

6. *Nutritional Status*

In the initial 24 hours following major procedures, rodents frequently are reluctant to “reach up” to the wire bar lid for food. Certain procedures can also impinge on the intake of adequate calories (Holte and Kehlet, 2002). Narcotics are also known to interfere with appetite in rodents (Jacobson, 2000). Soaking a few pellets in warm water and placing them in a shallow dish (Petri) on the cage bottom may encourage them to eat. Providing nutritional supplements can also stimulate appetite as well as provide a tool for assessing appetite. This is particularly effective if the surgical animals are identified at least 1 week prior to surgery and the nutritional supplements are introduced to offset the “novelty” effect. Sick animals, like humans, can be very picky in their eating selections and may ignore a new food that under normal circumstances they would readily eat. Fresh fruit, protein-enriched gelatin, peanut butter, and Bacon Softies™ (Bio-Serv, Frenchtown, NJ) are the types of treats that provide additional calories and fluid source (fruit), and also help stimulate the appetite. For anorectic, critically ill rodents, nutritional demands must be met via gavage or parenteral nutrition. Dextrose-containing fluids are not sufficiently calorie-dense to meet the daily resting energy requirement of anorectic animals and should be administered intravenously making these animals impractical for many rodent protocols. Alternatively, a high-fat,

high-protein cube of gelatin can be made in large quantities and refrigerated (Hampshire and Davis, 2000a). A dose of 0.25 cubes per mouse or 1 cube per rat per day is prescribed. Fresh fruit and gelatin should be removed from the cage within 24 hours and refrigerated gelatin kept no longer than 48 hours. If the animal does not eat any of the supplements offered and body weight continues to fall, it may be necessary to gavage the animal with a liquid, high-protein supplement. Geriatric animals may invariably incur renal losses of protein as they age. Our experience with aged rodents is that they may be unwilling to develop postures in which feeding is optimized. In this case fat- and protein-dense supplements on the cage floor may be indicated and may necessitate a change in SOPs. Cage tags entitled “cage feeding by medical direction” are useful for this purpose.

Critically ill large animals also undergo periods of anorexia. Some analgesics can cause anorexia or aberrant behaviors that are associated with anorexia (Bender, 1998; Clarke et al., 1997). Animals that are not eating after 5 days of optimal care should be considered candidates for supplemental fat, protein, and carbohydrates. Again, a central line will permit the administration of protein and fat supplements. Nasogastric, esophageal, or duodenal feeding tubes have also been utilized for animal models of critical care (Dudrick, 2003; Garcia-Gamito et al., 1991; Han, 2004; Pennington et al., 1988).

7. *Methods of Dose Administration in Rodents*

Dosing medications to achieve steady-state blood concentrations is challenging in small animals with a high metabolic rate, whose surface-to-volume ratio is roughly 10 times that of humans. Other than high metabolic rate, small rodents present other practical problems and great challenges for those assigned the responsibility of monitoring and care of post-procedural mice and rats. Their muscle mass is small, which means injected drugs can easily cause tissue damage (consider pH, osmolality, and isotonicity) or fail to be absorbed properly. Two possible stress-related problems are (1) the stress of handling and restraint for repeated drug administration, and (2) the stress associated with a painful needle stick. The difference in response to handling and drug administration is striking in rodents; for example, the DA and Lewis strains of rats react very differently to handling and pain than Sprague-Dawley (stock) rats (personal experience with rat liver transplantation studies). These differences should be considered during presurgical planning for nursing care. An additional challenge in working with rodents is the variation in response to drugs and dosages between animals of different strains, gender, and age (similar to people) (Lovell, 1986).

An easy method of providing fluids and analgesics in a combination regimen subcutaneously, with minimal disturbance to the animal, is the use of butterfly catheters. A variety of 1- and 3-mL syringes, needle sizes, and broad-spectrum antibiotics should be readily accessible.

a. Oral (PO)

Oral administration in rodents has another set of problems that can be difficult to overcome. First, rodents are often group housed; ensuring that each cage inhabitant eats their fair share of the drug article is impossible. Second, rodents are notoriously picky with “novel food items”—a behavior that is amplified when they do not feel well. Third, if they have poor appetite or are not eating, oral delivery is not an option unless you plan to individually gavage the animals—a technique that requires skilled personnel, experience, and a lot of time. Fourth, the drug selected must not be significantly metabolized before effective blood concentrations are achieved (Brewster et al., 1981). The dose may need to be increased significantly above a dose used for subcutaneous (SQ) or intramuscular (IM) delivery to achieve similar efficacy, but higher doses may have untoward side effects (ulcerogenic threshold for NSAIDs, for example).

b. Subcutaneous (SQ)

SQ administration of fluids and medications is a popular route of administration in rodent patients. Generally, it is easy to restrain mice or rats and deliver a calculated bolus (Fig. 9-6b) in single or divided daily doses in the neck or scapula region. For more recalcitrant animals, the use of a butterfly catheter allows the animal to remain in its cage while administering the drug. For optimal absorption, drugs should be hypo-osmolar (<300 mOsm). Necrosis at the site of entry is a major side effect with highly acidic or alkaline substances but sterility is not as much a problem with SQ administration as it is with IM and IV injections. Immunodeficient animals should not receive anything that has not been sterilized and aseptically prepared.

Slow and continuous-release options have also become available for transcutaneous (TC) and SQ rodent delivery systems. ALZET[®] osmotic pumps allow continuous delivery of agents at controlled rates when placed subcutaneously or intraperitoneally. If targeted delivery of a drug to an area remote from the site of implantation is required, a catheter can be attached to the pump. These pumps come in various sizes with different volume reservoirs. The manufacturer provides an explant schedule, based on the pump model, once the pump is empty. This is important because this type of pump is an inert object for only a short period of time before it begins to attract water into the pump (osmotic forces), which causes the pump to swell. At this point, the pump can either rupture or leak a concentrated salt solution that damages the tissue (www.alzet.com/products/imp_exp.php) (Table 9-3).

The ESOX ([Norfolkaccess.com](http://www.norfolkaccess.com)) implantable pump is another option. This system, with its refillable reservoir, enables truly long-term drug delivery. One other delivery system marketed by Innovative Research (<http://www.innovrsh.com>) is a time-release matrix-driven biomedical delivery system in a pelleted form that can easily be placed in an SQ pocket. The

TABLE 9-3

COMMONLY MENTIONED VENDORS

1.	Iso-PAD [™] : Omni BioResources, Inc.; Cherry Hill, NJ
2.	ALZET [®] : DURECT Corporation, Cupertino, CA
3.	Bacon Softies [™] : Bio-Serve, Frenchtown, NJ
4.	EMLA [®] Crème (2.5% lidocaine +2.5% prilocaine): AstraZeneca, Wilmington, DE
5.	Warm Buddies ‘N Pals [™] : Heat Factory, Vista, CA
6.	Arizant Bair Hugger Model 750: Arizant Health Care, Eden Prairie, MN
7.	Radiometer ABL77: Radiometer America, Westlake, OH
8.	Foers Pharmacy, Bethesda, MD
9.	ESOX pumps; www.Norfolkaccess.com/pumps/html or Access Technologies, Norfolk Medical Products, Skokie, IL
10.	Innovative Research of America, Sarasota, FL
11.	Harvard IV tether system for Rodents: Instech Soloman, Plymouth Meeting, PA. www.instechlabs.com/downloads/systems.pdf
12.	IDEXX Laboratories, Westbrook, ME

Disclaimer: The mention or lack of mention of a specific brand is neither an endorsement nor a disapproval of a particular brand name. The names mentioned are simply those that have been utilized by the authors.

company lists nearly all compounds of drugs and also will prepare special formulations.

c. Transcutaneous (TC)

The advent of pain medications in topical gels and creams allows systemic absorption of active drugs after application. Drugs where this approach has been successful include ketoprofen, fentanyl, nitroglycerin, and motion-sickness drugs. Pharmacists who formulate drugs to create crèmes with higher concentrations of lidocaine and NSAIDs have used Organogel, a lecithin-based matrix. This approach may allow for another innovative approach to provide stress-free drug delivery but should be verified with a pharmacokinetic study to confirm that adequate drug levels are actually delivered and that the desired pharmacologic effect (analgesia, antibiotic, etc.) is achieved.

d. Intravenous (IV)

With practice, it is also possible to cannulate mouse and rat jugular and femoral veins. It is also possible to purchase mice and rats already instrumented with intravascular access. If successful, this makes IV drug delivery available. Alternatively, a number of companies now make mouse infusion systems with swivels that have low rotational friction. The challenge for indwelling catheters is maintaining them and making sure the rodent does not chew or remove the catheter.

e. Intramuscular (IM)

Due to small muscle mass, IM injections are discouraged in rodents and are less than ideal in large animals as well. Necrosis and pain at the injection site are unpleasant sequelae, and irritation of the sciatic nerve with resulting polyneuropathy is not an

uncommon occurrence in mice and rats. If an investigator must use the IM route, training in the anatomy of the hind limb is the best practice. The volume delivered at a single site must also be limited in rats and mice (0.1–0.3 mL in rats and 0.05–0.1 mL in mice). This often translates into multiple injection sites in order to deliver the full dose of the drug. The lumbar muscles are also potential sites for IM injection but again, they are very thin and often the needle goes through the muscle, which means the drug is not appropriately delivered. If working with obese rodents (leptin knockouts, for example), their high body fat content serves as a barrier for accurate drug delivery using the IM route.

f. Intraperitoneal (IP)

IP drug delivery is overused in rodent studies and carries many concerns such as contamination, splenic trauma, serosal hemorrhage, drug delivery into visceral organs or fat pads, and other untoward effects. Hence, selection of this method of delivery should be given a thought, and the skill of the technician will be critical to ensure accurate delivery.

VI. RECORD KEEPING

Trending of animal wellness is the crux of postprocedural care and use. For this reason, records management is a mainstay for establishing a sound postprocedural program. Whether a program utilizes computerized or paper records is not as important as whether record-keeping procedures are consistent and comprehensive. Methods of record-keeping have been extensively discussed (Hampshire, 2001; Hampshire and Davis, 2000b).

A. Rats and Mice

If the program uses a decentralized approach to caring for rodents, a wall-desk located immediately outside the holding room is ideal. Folders should contain disposition sheets that contain key points of contact (principal investigator and attending veterinarian). Each box of rodents that are under treatment should have a record indicating the number of animals and the protocol number, and identifying markers such as tattoos or ear tags. Postprocedural records should have sections by which users can determine daily trends in overall scores, weights, and other objective information in order to assess the progress of each animal over time. If the record is a 5 × 7 in. index card, one side can contain the objective information while the flip side can contain daily logs of written information or descriptors. If the program is using computerized records, the screens can be tabbed for the selection of postprocedural objective information and trends and/or written observations and plans.

If the program uses a centralized approach or a decentralized approach with centralized command structure we also advocate a method for indexing return visits or rechecks so that the

records of animals that are taken off observation or placed on reduced observational frequency appear in a reminder area for a recheck. An index card box with locations for weekly, biweekly, and monthly rechecks is a simple way to attain this standard. Computerized systems may use a system of calendar reminders for this purpose.

B. Large Animals

Large research animals should have individual records. A disposition sheet with key points of contact, protocol number, and master problem list should be the first page in the record. Blood work and vital signs should be next in line in charts that permit ease of interpretation of the trend of each vital sign or variable. Next, daily treatment and observation notes should be recorded so that in-depth findings and information can be interpreted (Haskins, 1997). We find flip charts useful for protecting written records in a plastic shield. Computerized record-keeping systems that are made for veterinary hospitals are also a nice choice for detailed information and are becoming more commonplace in research settings. However, adequate backup systems should be in place to protect this information and access should not be so difficult as to restrict routine and frequent entries by all caregivers.

VII. CONCLUSIONS

The landscape of 21st century animal care has experienced a transformation of research protocols heavily imprinted by rodent care and use. Concomitantly, there has been a cultural shift raising the bar for the level of postprocedural care that is both possible and expected. Although individual participants in this field do not all agree on levels of care that are necessary for any one particular protocol, most would agree that the minimization of research variables is paramount and that a multitude of favorable impacts on research is experienced when such variability is controlled.

REFERENCES

- Adamcack, A., and Otten, B. (2000). *Vet. Clin. North Am. Exot. Anim. Pract.* 3(1), 221–237.
- American Association of Laboratory Animal Science (2007). <http://www.aalas.org>. (Accession date July 7, 2007).
- American College of Laboratory Animal Medicine (ACLAM) (2007). http://www.aclam.org/education/guidelines/positionon_adequatecare.html. (Accession date July 7, 2007).
- Atinoff, N. (1998). Small mammal critical care. *Vet. Clin. North Am. Exot. Anim. Pract.* 1(1), 153–176.
- Battaglia, A.M. (2001). “Small Animal Emergency and Critical Care.” pp 41–43. W.B. Saunders, Ithaca, NY.
- Bender, H.M. (1998). Pica behavior associated with buprenorphine administration in the rat. *Lab. Anim. Sci.* 48, 5.

- Brainard, G.C., Barker, F.M., Hoffman, R.J., Stetson, M.H., Hanifin, J.P., Podolin, P.L., and Rollag, M.D. (1994). Ultraviolet regulation of neuroendocrine and circadian physiology in rodents. *Vision Res.* **34**(11), 1521–1533.
- Brewster, D., Humphrey, M.J., and McLeavy, M.A. (1981). The systemic bioavailability of buprenorphine by various routes of administration. *J. Pharm. Pharmacol.* **33**, 500–506.
- Clarke, J.A., Myers, P.H., Goelz, M.F., Thigpen, J.E., and Forsythe, D.B. (1997). Pica behavior associated with buprenorphine administration in the rat. *Lab. Anim. Sci.* **47**, 300–303.
- Clavijo-Alvarez, J.A., Sims, C.A., Pinsky, M.R., and Puyana, J.C. (2005). Monitoring skeletal muscle and subcutaneous tissue acid-base status and oxygenation during hemorrhagic shock and resuscitation. *Shock* **24**(3), 270–275.
- Commission on Life Sciences, National Research Council. (1996a) “Guide for the Care and Use of Laboratory Animals.” National Academies of Science Press, Washington, DC.
- Commission on Life Sciences, National Research Council. (1996b). “Laboratory Management of Rodents.” National Academies of Science Press, Washington, DC.
- Connally, H.E. (2002). Critical care monitoring considerations for the diabetic patient. *Clin. Tech. Small Anim. Pract.* **17**(2), 73–78.
- Cooper S. (2006). The effect of preoperative warming on patients’ postoperative temperatures. *AORN J.* **83**(5), 1074–1077, 1079–1084.
- Dartmouth University (2007). http://dms.dartmouth.edu/arc/arc/analgesia_anesthesia/mice/shtml. (Accession date July 7, 2007). http://dms.dartmouth.edu/arc/arc/analgesia_anesthesia/mice/shtml. (Accession date July 7, 2007).
- Denborough, M. (1998). Malignant hyperthermia. *Lancet* **352**(9142), 1785.
- Dennis, M.B., Jr., Graham, T.C., Raff, R.F., Jones, D.R., Schuening, F., and Storb, R. (1993). Implanted right atrial catheters for continuous infusion of solutions into dogs. *J. Invest. Surg.* **6**(5), 461–467.
- Dudrick, S.J. (2003). Early developments and clinical applications of total parenteral nutrition. *J. Parenter. Enteral. Nutr.* **27**(4), 291–299.
- Flecknell, P.A., and Liles, J.H. (1991). Evaluation of locomotor activity and food consumption as a method of assessing postoperative pain in rodents. In “Animal Pain.” (C.E. Short and V. Poznak, eds.), pp 482–488. Churchill-Livingstone, New York.
- Fossum, S., Hays, J., and Henson, M.M. (2001). A comparison study on the effects of prewarming patients in the outpatient surgery setting. *J. Perianesth. Nurs.* **16**(3), 187–194.
- Fox, J.G., Anderson, L.C., Low, F.M., and Quimby, F.W. (2002). “Laboratory Animal Medicine.” 2nd ed., 128 pp. Academic Press, New York.
- Frank, S.M., Higgins, M.S., Breslow, M.J., Fleisher, L.S., Gorman, R.B., Sitzmann, J.V., Raff, H., and Beattie, C. (1995). The catecholamine, cortisol, and hemodynamic responses to mild perioperative hypothermia. A randomized clinical trial. *Anesthesiology* **82**(1), 83–93.
- Garcia-Gamito, F.J., Moran, J.M., and Mahedero, G. (1991). Long term peritoneal nutrition in dogs, both normal and after intestinal resection. *Int.Surg.* **76**(4), 235–240.
- Giesbrecht, G.G., Ducharme, M.B., and McGuire, J.P. (1994). Comparison of forced-air patient warming systems for perioperative use. *Anesthesiology* **80**(3), 671–679.
- Gonder, J.A., and Laber, K. (2007). A renewed look at laboratory rodent housing and management. *ILAR J.* **48**(1), 29–36.
- Hamlin, R.L. (1992). Current uses and hazards of ventricular antiarrhythmic therapy. In “Current Veterinary Therapy XI: Small Animal Practice.” (R.W. Kirk, and J.D. Bonagura, eds.), pp 694–700. W.B. Saunders, Philadelphia.
- Hampshire, V.A. (2001). Handheld digital equipment for weight composite distress paradigms: New considerations and for rapid documentation and intervention of rodent populations. *Contemp. Top. Lab. Anim. Sci.* **40**(4), 11–17.
- Hampshire, V.A. (2005). Personal Experiences in Animal Shelter Management at Louisiana State University Parker Coliseum animal Shelter. September 7, 2005–October 22, 2005.
- Hampshire, V.A., and Davis, J.A. (2000a). Red-carpet rodent care: Making the most of dollars and sense in the animal facility. *Lab. Anim.* **29**(5), 40–46.
- Hampshire, V.A., and Davis, J.A. (2000b). Technical team approaches to rodent care: Cost savings, reduced risk, and improved stewardship. *Lab. Anim.* **29**(8), 35–40.
- Hampshire, V.A., Davis, J.A., Williams, L., and Eskildson, H. (2001). Retrospective comparison of rat recovery weights using inhalation and injectable anaesthetics, nutritional and fluid supplementation for right unilateral neurosurgical lesioning. *Lab. Anim.* **35**(3), 223–229.
- Han, E. (2004). Esophageal and gastric feeding tubes in ICU patients. *Clin. Tech. Small Anim. Pract.* **19**(1), 22–31.
- Haskins, S.C. (1997). Postoperative support and intensive care. In “Anesthesia and Analgesia in Laboratory Animals.” (D.F. Kohn et al., eds.), pp 379–395. Academic Press, New York.
- Hawk, C.T., and Leary, S.L. (1999). “Formulary for Laboratory Animals.” 2nd ed., 78 pp. Iowa State University Press, Ames, IO. Table A.5.
- Heard, D. (2000). Perioperative supportive care and monitoring. *Vet. Clin. North Am. Exot. Anim. Pract.* **3**(3), 587–615.
- Hofstetter, J.R., Hofstetter, A.R., Hughes, A.M., and Mayeda, A.R. (2005). Intermittent long-wavelength red light increases the period of daily locomotor activity in mice. *J. Circ. Rhythms* **3**, 8.
- Holte, K., and Kehlet, H. (2002). Epidural anaesthesia and analgesia—effects on surgical stress responses and implications for postoperative nutrition. *Clin. Nutr.* **21**(3), 199–206.
- Ilbäck, N.G., and Stalhandske, T. (2003). Cardiovascular effects of xylazine recorded with telemetry in the dog. *J. Vet. Med. A Physiol. Pathol. Clin. Med.* **50**(100), 479–483.
- Jacobson, C. (2000). Adverse effects on growth rates in rats caused by buprenorphine administration. *Lab. Anim.* **34**, 202–206.
- Kirk, R.W., Bistner, S.I., and Ford, R.B. (1990). Fluid therapy. In “Handbook of Veterinary Procedures and Emergency Treatment.” 5th ed., 589 pp. W.B. Saunders, Philadelphia.
- Langlois, I. (2004). Wound management in rodents. *Vet. Clin. North Am. Exot. Anim. Pract.* **7**(1), 141–167.
- Lee, L., Leslie, K., Kayak, E., and Myles, P.S. (2004). Intraoperative patient warming using radiant warming or forced-air warming during long operations. *Anaesth. Intensive Care* **32**(3), 358–361.
- Lovell, D.P. (1986). Variation in pentobarbitone sleeping time in mice; strain and sex differences. *Lab. Anim.* **20**(2), 85–90.
- Lucas, E.A., Powell, E.W., and Murphree, O.D. (1977). Baseline sleep-wake patterns in the pointer dog. *Physiol Behav.* **19**(2), 285–291.
- Marx, K.L., and Raston, M.A. (2007). “Exotic Animal Drug Compendium; an International Formulary.” Currently out of print and availability by web access orders at <http://www.exoticanimal.net/drugbook/BookInformation/animal.html>. (Accession date July 7, 2007).
- Mathews, K. (1998). The various types of parenteral fluids and their indications. *Vet. Clin. North Am. Small Anim. Pract.* **28**(3), 483–513.
- Mathews, K. (2006). “Emergency and Critical Care.” LifeLearn Inc., Guelph, Ontario, 356.
- Miyazaki, H., Yoshida, M., Samura, K., Matsumoto, H., Ilkamoto, F., and Tagawa, M. (2002). Ranges of diurnal variation and the pattern of body temperature, blood pressure, and heart rate in laboratory beagle dogs. *Exp. Anim.* **51**(1), 95–98.
- Moons, C.P., Van Wiehle, P., and Odberg, F.O. (2004). To enrich or not to enrich: Providing shelter does not complicate handling of laboratory mice. *Contemp. Top. Lab. Anim. Sci.* **43**(4), 13–21.
- Morton, D.B., Jennings, M., Buckwell, A., Ewbank, R., Godfrey, C., Holgate, B., Inglis, L., James, R., Page, C., Sharman, I., Verschovic, R., Westall, L., and Wilson, A.B. (2001). Joint Working Group on Refinement. Refining procedures for the administration of substances. Report of the BVAAWF/FRAME/RSPCA/UFWF Joint Working Group on Refinement. British Veterinary Association Animal Welfare Foundation/Fund for the Replacement of Animals in Medical Experiments/Royal Society for

- the Prevention of Cruelty to Animals/Universities Federation for Animal Welfare. *Lab. Anim.* **35**(1), 1–41.
- Morton, D.B. (2000). A systematic approach for establishing humane endpoints. *ILAR J.* **41**(2), 80–86.
- Najafi, N., and Ludomirsky, A. (2004). Initial animal studies of a wireless, batteryless, MEMS implant for cardiovascular applications. *Biomed. Microdevices* **6**(1), 61–65.
- Natanson, C. (1990). Studies using a canine model to investigate the cardiovascular abnormality of and potential therapies for septic shock. *Clin. Res.* **38**(2), 206–214.
- Olsson, I.A., and Dahlborn, K. (2002). Improving housing conditions for laboratory mice: A review of “environmental enrichment.” *Lab. Anim.* **36**(3), 243–270.
- Panksepp, J. (2005). Beyond a joke: From animal laughter to human joy? *Science* **308**(5718), 62.
- Panksepp, J. (2007). Neuroevolutionary sources of laughter and social joy: Modeling primate human laughter in laboratory rats. *Behav. Brain Res.* **182**(2), 231–244.
- Patel, N., Smith, C.E., Pinchak, A.C., and Hagen, J.F. (1996). Prospective, randomized comparison of the Flotem Iie and Hotline fluid warmers in anesthetized adults. *J. Clin. Anesth.* **8**(4), 307–316.
- Pennington, L.R., Lumney, J.K., and Sachs, D.H. (1988). Bone marrow transplantation in miniature swine: Development of the model. *Transplantation* **45**(1), 21–26.
- Peterson, N.C. (2004). Assessment of pain scoring. *Contemp. Top. Lab. Anim. Sci.* **43**(1), 74–76.
- Plumb, D.C. (2002). “Veterinary Drug Handbook.” University of Minnesota Press, Minneapolis.
- Podrid, P.J., Fuchs, T., and Candinas, R. (1990). Role of the sympathetic nervous system in the genesis of ventricular arrhythmia. *Circulation* **82**(2), 1103–1113.
- Public Health Service Policy on Humane Care and Use of Laboratory Animals (2002). Office of Protection from Research Risks, NIH, Bethesda, MD.
- Roughan, J.V., Flecknell, P.A. (2001). Behavioural effects of laparotomy and analgesic effects of ketoprofen and carprofen in rats. *Pain* **90**, 65–74.
- Rudloff, E., and Kirby, R. (1998). Fluid therapy: Crystalloids and colloids. *Vet. Clin. North Am. Small Anim. Pract.* **28**(2), 297–328.
- Satas, S., Haaland, K., Thoresen, M., and Steen, P.A. (1996). MAC for halothane and isoflurane during normothermia and hypothermia in the newborn piglet. *Acta Anaesthesiol. Scand.* **49**(4), 452–456.
- Schaer, M. (1998). Advances in fluid and electrolyte disorders. *Vet. Clin. North Am.* **28**(3), 479
- Sims, C., Seigne, P., Menconi, M., Monarca, J., Barlow, C., Pettit, J., and Puyana, J.C. (2001). Skeletal muscle acidosis correlates with the severity of blood volume loss during shock and resuscitation. *J. Trauma* **51**(6), 1137–1145.
- Smith, A.L., and Corrow, D.J. (2005). Modifications to husbandry and housing conditions of laboratory rodents for improved well-being. *ILAR J.* **46**(2), 140–147.
- Smith, J.J., Hadzic, V., Li, X., Liu, P., Day, T., Utter, A., Kim, B., Washington, I.M., and Basso, M.A. (2006). Objective measures of health and well-being in laboratory rhesus monkeys (*Macaca mulatta*). *J. Med. Primatol.* **35**(6), 388–396.
- Soloviev, M.V., Hamlin, R.L., Shellhammer, L.J., Barrett, R.M., Wally, R.A., Birchmeier, P.A., and Schaefer, G.J. (2006). Variations in hemodynamic parameters and ECG in healthy conscious, freely moving telemetrized beagle dogs. *Cardiovasc. Toxicol.* **6**(1), 51–62.
- Stasiak, K.L., Maul, D., French, E., Hellyer, P.W., and VandeWoude, S. (2003). Species-specific assessment of pain in laboratory animals. *Contemp. Top. Lab. Anim. Sci.* **42**(4), 13–20.
- Swindle, M.M., Nolan, T., Jacobson, A., Wolf, P., Dalton, M., and Smith, A. (2005). Vascular Access Port (VAP) use in large animal species. *Contemp. Top. Lab. Anim. Sci.* **44**(3), 7–17.
- Turner, J.G., Parrish, J.L., Hughs, L.F. Toth, L.A., and Caspary, D.M. (2005). Hearing in laboratory animals: Strain differences and nonauditory effects of noise. *Comp. Med.* **55**(1), 12–23.
- Vanni, S.M., Braz, J.R., Modolo N.S., Amorim, R.B., and Rodrigues, G.R., Jr. (2003). Preoperative combined with intraoperative skin-surface warming avoids hypothermia caused by general anesthesia and surgery. *J. Clin. Anesth.* **15**(2), 119–125.
- Title 9, 7 USC (1985). The Animal Welfare Act. Parts 2.131–2.156, 2.33.
- Tsai, P.P., Pachowsky, U., Stelzer, H.D., and Hackbarth, H. (2002). Impact of environmental enrichment in mice. 1: Effect of housing conditions on body weight, organ weights and haematology in different strains. *Lab. Anim.* **36**(4), 411–419.
- Van de Weerd, H.A., Van Loo, P.L., Van Zutphen, L.F., Koolhaas, J.M., and Baumans, V. (1997). Preferences for nesting material as environmental enrichment for laboratory mice. *Lab. Anim.* **31**(2), 133–143.
- University of Edinburgh (2007). <http://www.vet.ed.ac.uk/animalpain/Pages/assessed.htm>. (Accession date July 7, 2007).
- University of Newcastle (2005). <http://www.ahwla.org.uk/> (Accession date July 7, 2007).
- University of Pittsburg (2007). <http://www.iacuc.pitt.edu/druglist.pdf>. (Accession date July 7, 2007).
- Waynforth, H.B., and Flecknell, P.A. (1992). Anaesthesia and postoperative care. In “Experimental and Surgical Technique in the Rat.” (H.B. Waynforth and P.A. Flecknell, eds.), 2nd ed., pp 100–152. Academic Press, San Diego, CA.
- Wilson, D., Pettifer, G.R., and Hosgood, G. (2006). Effect of transdermally administered fentanyl on minimum alveolar concentration of isoflurane in normothermic and hypothermic dogs. *J. Am. Vet. Med. Assoc.* **229**(7), 1042–1046.
- Wolfer, D.P., Litvin, O., Morf, S., Nitsch, R.M., Lipp, H.P., and Wurbel, H. (2004). Laboratory animal welfare: Cage enrichment and mouse behavior. *Nature* **432**(7019), 821–822.

This page intentionally left blank

Section III

**Practical Anesthesia and Analgesia of
Traditional Laboratory Animal Species**

This page intentionally left blank

Chapter 10

Anesthesia and Analgesia for Laboratory Rodents

Diane J. Gaertner, Troy M. Hallman, F. Claire Hankenson, and Margaret A. Batchelder

I.	Introduction	240
II.	Considerations in Selection of Anesthetics for Rodents	245
A.	Animal Considerations	245
B.	Procedure Considerations	248
C.	Practical Considerations	248
III.	General Anesthetic Plan	249
A.	Preparation for Anesthesia	249
B.	Preanesthetic Drugs	249
C.	Intraoperative and Recovery Support	249
D.	Sequential Surgeries on a Number of Rodents in a Single Session	250
IV.	Recommended Anesthetic Methods for Routine Use in Rodents	250
A.	Inhalant Anesthetics	250
B.	Injectable Anesthetics	256
V.	Drugs Used as Adjuvants to Primary Anesthetic Agents	261
A.	Anticholinergics	262
B.	α -2 Adrenergic Agonists: Xylazine and Medetomidine	262
C.	Phenothiazine Tranquilizers	262
D.	Benzodiazepines: Diazepam	263
E.	The Action and Use of Opioids in Anesthesia	263
F.	Cholinergic Agents	264
G.	Local Anesthetics for Anesthesia and Analgesia	264
H.	Neuromuscular Blockade in Rodent Anesthesia	265
VI.	Anesthetic Regimens Used for Special Purposes	265
A.	Inactin: Anesthesia of Long Duration	265
B.	Alpha Chloralose: Maintenance of Respiratory and Cardiac Reflexes During Anesthesia	265
C.	Urethane: Long Duration Anesthesia with Preservation of Autonomic Reflexes	265
D.	Ether: Historical Precedent and Use by Open-Drop Methods	266
VII.	Other Anesthetics	266
A.	Chloral Hydrate	266
B.	Steroid Anesthetics	266
VIII.	Use of Neuromuscular Blocking Agents and Antagonists	266
A.	Depolarizing Neuromuscular Blocking Agents	267
B.	Nondepolarizing Neuromuscular Blocking Agents	267
C.	Neuromuscular Blocker Antagonists	267

IX. Analgesics for Mice and Rats	268
A. Assessment of Pain in Experimental Rodents	268
B. Timing of Analgesia	268
C. Opioid Analgesics	269
D. Nonsteroidal Anti-Inflammatory Agents	272
E. Other Agents with Analgesic Action	274
F. Adjuncts to Analgesia in Rodents	275
G. Analgesic Use in Immunologic, Inflammation, and Tumor Studies	276
X. Anesthesia and Analgesia in Neonatal Mice and Rats	277
A. Anesthetics	278
B. Analgesics	278
XI. Special Considerations for Postprocedural Monitoring of Rodents	278
XII. Other Rodents, Including Guinea Pigs, Hamsters, and Gerbils	279
A. Guinea Pigs	279
B. Hamsters	280
C. Gerbils	281
D. Other Rodents	281
References	282

I. INTRODUCTION

Knowledge of the advantages, disadvantages, and complications of commonly used anesthetics and analgesics is essential for a veterinarian practicing laboratory animal medicine. In this role, the veterinarian utilizes his or her knowledge of anesthetics and analgesics to promote humane and effective research through input into the protocol review process, teaching of anesthetic techniques, informed selection and direct or delegated administration of appropriate anesthetics and analgesics, and assistance to scientists when there are problems with anesthetic aspects of procedures.

In the biomedical research environment, administration of anesthesia and analgesia is routinely performed by scientists and members of the scientific group without the direct supervision of a veterinarian. Institutions provide advice to and training of these scientists through their veterinary and training staff. For rodents, regulations in the United States allow anesthesia in locations remote from the central vivarium such as the laboratory, where direct observation of the efficacy of anesthesia by laboratory animal veterinarians is not routine. Because of the indirect role of the veterinarian in anesthesia and the frequently remote location of rodent anesthesia, we have selected the most reliable, safest, and simplest methods of anesthesia and analgesia in this chapter. We have emphasized the use of inhalant anesthetics such as isoflurane and of injectable combinations including ketamine because of the increasing popularity of these methods. Other, seldom-used methods have been de-emphasized in order to focus the reader's attention on current best practice methods of laboratory animal anesthesia. We have supplemented this selection with information about those additional anesthetics and analgesics that are used due to their special characteristics such as minimal cardiovascular depression. Table 10-1 lists the commonly used anesthetics, analgesics, and reversal agents, with their trade names and recommended dose ranges by species.

Assessment of discomfort and distress in animals can be difficult (Koch, 2006), particularly in prey species like rodents that tend naturally to hide any overt signs of pain that could impact their survival. Personnel may neglect to provide appropriate anesthesia or analgesia to rodents due to their inability to comfortably assess and recognize pain in animals, lack of knowledge about appropriate medications, and fear of untoward side effects (Robertson, 2001). Table 10-2 lists the behavioral symptoms of pain in rodents to assist the reader in this assessment.

Laboratory animal professionals are mandated by "The U.S. Government Principles for the Utilization and Care of Vertebrate Testing, Research and Training" (1985), the Public Health Service Policy (IV.C.1.b) (PHS, 2002), and The Animal Welfare Regulations (9CFR 2.c.) (Code of Federal Regulations, 2002) to select appropriate agents for use in various animal species that are compatible with sound scientific methods. More specifically, one must administer appropriate sedation, analgesia, or anesthesia to animals undergoing procedures that cause more than momentary or slight pain or distress. Sedative drugs induce a relaxed state, analgesics reduce or relieve pain without loss of consciousness, and anesthetics render the animal unconscious without loss of vital functions. The avoidance or minimization of discomfort, distress, and pain in laboratory animals is a moral imperative for all individuals who work with these species in biomedical research (Koch, 2006).

No matter which type of anesthetic is selected, it is important to provide appropriate and gentle restraint, a sufficient amount of analgesia to diminish pain sensation during the procedure, and relaxation of muscle tone to the degree that procedures can be performed quickly and efficiently (Flecknell, 1993b). Strain differences in rodents must be taken into account and pilot studies should be undertaken when changing to a new anesthetic regimen in research models (Flecknell, 1993a). Table 10-3 lists the published effects of various genetic backgrounds on the effects of analgesics and anesthetics.

TABLE 10-1
RECOMMENDED ANESTHETICS, ANALGESICS, AND REVERSAL AGENTS FOR MICE AND RATS

Drug	Species	Use	Dosage unless otherwise specified (mg/kg)	Route	References
Acetaminophen (Tylenol [®])	Rats	AG	50	SC, IP	Abbott and Hellemans (2000)
	Rats	AG	100	PO	Millecamps et al. (2005)
	Rodents	AG	110–305	PO	Flecknell (1984)
	Rodents	AG	110–305	IP	
Alpha chloralose	Mice	A	114 of a 5% solution	IP	Field and Lang (1988), Rieg et al. (2004)
	Rats	A	31–65	IP	White and Field (1987)
Alphaxalone-alphadolone (Saffan [®] , Althesin [®])	Mice	A	60–150	IM	Child et al. (1971), Glen (1980), Green et al. (1978), Rank and Jensen (1989)
	Mice	A	60–120	IP	
	Rats	A	10–25	IV	
	Rats	A	25–30	IP	
Aspirin	Rats	AG	100	PO	Jablonski and Howden (2002)
	Rodents	AG	20	SC	Flecknell (1984)
	Rodents	AG	100–120	IP	
Atipamezole (Antisedan [®])	Rats	R	0.5	SC	Hahn et al. (2005), Hedenqvist et al. (2000b), MacDonald et al. (1989)
Atracurium (Tracurium [®])/fentanyl	Rats	NMB	15 mg/(kg h) A CRI/ 1.25 mg/(kg h) F	IV	Bohrer et al. (1994)
Atracurium/isoflurane	Rats	NMB	360 µg/kg A/1.25 MAC I	IV	Shin et al. (1992)
Atracurium/sevoflurane	Rats	NMB	311 µg/kg A/1.25 MAC S	IV	Shin et al. (1992)
Bupivacaine (Marcaine [®])	Rodents	LA	Local infiltration	SC	Hassan et al. (1993), Hayes and Flecknell (1999)
Buprenorphine (Buprenex [®])	Mice	AG	2	SC	Gades et al. (2000)
	Mice	AG	1.1 mM in DMSO	Topical	Kolesnikov et al. (2000)
	Rodents	AG	0.002–0.055	IV	Christoph et al. (2005)
	Rodents	AG	0.04–0.13	IP	
	Rats	AG	0.05–0.5	SC, IP	Abbott and Bonder (1997), Gades et al. (2000), Stewart and Martin (2003a), Roughan and Flecknell (2004)
	Rats	AG	0.4	PO	Roughan and Flecknell (2004)
Butorphanol (Torbugesic [®] , Torbutrol [®] , Stadol [®])	Mice	AG	5	SC	Gades et al. (2000)
	Rats	AG	2	SC	
	Rats	AG	2	SC	
Carbon dioxide	Guinea pigs	A	80% for 60 seconds	Inhaled	Kohler et al. (1999)
	Mice	A	80% for 120 seconds	Inhaled	
	Rats	A	80% for 60 seconds	Inhaled	
Carprofen (Rimadyl [®])	Rats	AG	5–15	SC	Roughan and Flecknell (2001)
Celecoxib (Celebra [®])	Rats	AG	10–20	PO	Millecamps et al. (2005), Whiteside et al. (2004)
Chloral hydrate (Noctec [®])	Mice	A	370–400	P	Field (1988), White and Field (1987)
	Rats	A	300–450	IP	Field et al. (1993), Silverman and Muir (1993)
	Rats	A	400–600	SC	
	Rats	A	400–600	SC	
Clonidine (Catapres [®] , Combipres [®])	Mice	AG	0.25–0.5	PO	Jain et al. (2002)
	Mice	AG	0.001–0.1	IP	Sluka and Chandran (2002), Sabetkasaie et al. (2004)
Clonidine/morphine	Rats	AG	0.025 C/0.5	IP	Gurtu et al. (1994)
Diclofenac (Voltaren [®])	Mice	AG	9.0–28	IP	Santos et al. (1998)
Dipyrrone (Metamizol [®])	Rats	AG	50–600	SC, IP, IV	Abbott and Bonder (1997), Abbott and Hellemans (2000), Hernandez-Delgadillo and Cruz (2006), Hernandez-Delgadillo et al. (2003), Laird and Cervero (1996), Laird et al. (1998)
	Rats	AG	177–600 D/3.1–3.2	SC, IV	Hernandez-Delgadillo and Cruz (2006), Hernandez-Delgadillo et al. (2002, 2003)
Ethyl carbamate (Urethane [®])	Rats	A	1,000–1,500	IP	Field (1988), Severs et al. (1981)
Ethyl carbamate (Urethane [®])/alpha chloralose	Rats	A	250–400 E (30 minutes prior to alpha chloralose 114 mg/kg)	IP	Dalkara et al. (1995), Hughes et al. (1982)
	Rats	A	250–400 E (30 minutes prior to alpha chloralose 114 mg/kg)	IP	
Fentanyl (Sublimaze [®])	Mice	AG	0.025–0.6	SC	El Mouedden and Meert (2005)
	Mice	AG	0.032	SC	Schmidt et al. (1985)
	Rats	AG	0.01–1.0	SC	Colpaert et al. (2001), Meert and Vermeirsch (2005), Stewart and Martin 2003a and 2003b
	Rats	AG	2.0–4.0 g/day	PO	Colpaert et al. (2001)

(Continued)

TABLE 10-1

(CONTINUED)

Drug	Species	Use	Dosage (mg/kg) unless otherwise specified	Route	References
Fentanyl/fluanisone/diazepam	Mice	A	0.1–0.3 ml of a 1:10 dilution of Hypnorm: 5 D/30 g mouse	IP, SC	Green (1975), Flecknell (1993)
Fentanyl/fluanisone/midazolam	Mice	A	3.313 mg fentanyl, 104.8 mg fluanisone, 52.42 mg midazolam/kg	SC, IP	Flecknell (1996, 1993), Flecknell and Mitchell (1984), Jong et al. (2002)
Flumazenil (Romazicon®)	Rodents	R	10 nmol	IP	Sarlis and Kaniaris (1991), Stackman and Walsh (1992)
Flunixin meglumine (Banamine®, Flunazine®)	Mice	AG	4.0–11	IV	Herrero and Headley (1996)
Gallamine/pentobarbital	Rats	NMB	4–10 G/60 P IP then 2–6 mg/kg/h IV CRI	IV	Gourine et al. (2003), Mishra and Ramzan (1993c)
Gallamine/urethane	Rats	NMB	4.0 bolus G, 3 mg/(kg h) G CRI/1.2 g/kg U repeated boluses	IV	Mishra and Ramzan (1992a, 1993c)
Ibuprofen (Advil®), Motrin®, Nuprin®)	Mice	AG	40	PO	Hayes et al. (2000)
Ibuprofen/hydrocodone	Rats	AG	200 I/2.3	SC	Zelcer et al. (2005)
Ibuprofen/methadone	Rats	AG	200 I/1.7	SC	Zelcer et al. (2005)
Ibuprofen/oxycodone	Rats	AG	200 I/0.5	SC	Zelcer et al. (2005)
Inactin (ETMU): see thiobarbital					
Isoflurane (Forane®)	Mice	I	0.04	Inhaled	Szczensy et al. (2004)
	Mice	A	0.08–1.5%	Inhaled	
	Neonatal mice	I	4%	Inhaled	Drobac et al. (2004)
	Neonatal mice	I	2%	Inhaled	Gotoh et al. (2004)
	Neonatal mice	A	0.25–2.5%	Inhaled	
	Rats	I	5%	Inhaled	Smith et al. (2004)
	Rats	A	0.25–2.5%	Inhaled	Vaillancourt et al. (1999), Wood et al. (2001)
Isoflurane/morphine	Rats	A	2% I/5 M	Inhaled, IP	Smith et al. (2004)
Ketamine (Ketaset®)/diazepam	Mice	A	100 K: 5 D	IP	Flecknell (1993)
	Rats	A	40 K: 5 D	IP	Wixson et al. (1987a)
Ketamine/medetomidine	Mice	A	50–75 K/1–10 M	IP	Cruz et al. (1998), Flecknell (1993), Hahn et al. (2005), Hedenqvist et al. (2000a), Taylor et al. (2000)
	Rats	A	60 K/0.4 M	IP	Hedenqvist et al. (2000a)
Ketamine/xylazine	Mice	P	37.5 K/2.5 X (with isoflurane)	IP	Hoff et al. (2006)
	Mice	A	90–150 K/7.5–16 X	IP	Clifford (1984), Flecknell (1993), Furukawa et al. (1998), Hahn et al. (2005), Zeller et al. (1998)
	Rats	A	40–80 K/5–10 X	IM, IP	Hsu et al. (1986), Stringer and Seligmann (1996), Wixson et al. (1987a)
Ketamine/xylazine/acepromazine	Mice	A	100 K/2.5 X/2.5 A	IM	Flecknell (1996)
	Rats	A	40 K/8.0 X/4.0 A	IM	Lawson et al. (2001)
Ketoprofen (Ketofen®)	Rats	AG	5–15%	SC	Roughan and Flecknell (2001)
	Rats	AG	10–20%	IP	Prado and Pontes (2002)
Levallorphan tartrate (Lorfan®)	Rodents	R	0.89	SC	Notarnicola et al. (1983)
Lidocaine (Xylocaine®)	Rats	AG	0.67–1.3 mg/(kg h) CRI	SC-pump	Smith et al. (2002)
Lidocaine/buprenorphine	Mice	AG	0.44 mM L/0.18 mM in DMSO	Topical	Kolesnikov et al. (2000)
Lidocaine/morphine	Mice	LA	0.85 mM L/1.7 mM in DMSO	Local	Kolesnikov et al. (2000)
Lidocaine/prilocaine cream (EMLA Cream®)	Rats	TA	Local application	Topical	Arevalo et al. (2004), Flecknell et al. (1990), Sintov and Shapiro (2004)
Medetomidine/fentanyl	Rats	A	200–300 µg/kg M/300 µg/kg	IP	Hu et al. (1992)
Medetomidine/sufentanil	Rats	A	150 µg/kg M/40–50 µg/kg	SC	Hedenqvist (2000b)

(Continued)

TABLE 10-1

(CONTINUED)

Drug	Species	Use	Dosage (mg/kg) unless otherwise specified	Route	References
Meloxicam (Metacam [®])	Mice	AG	1.0–10	IP	Santos et al. (1998)
	Rats	AG	1.0–4.0	SC, IP	Laird et al. (1997), Roughan and Flecknell (2003)
Meloxicam/tizanidine or clonidine	Mice	AG	0.5 M/0.25	PO	Jain et al. (2002)
Meperidine (Demerol [®])	Mice	AG	20	IP	Paris et al. (2005)
Methadone (Dolophine [®])	Rats	AG	0.5–3	SC	Erichsen et al. (2005)
Morphine (Duramorph [®])	Mice	AG	10	SC	Gades et al. (2000)
	Mice	AG	6.1 mM in DMSO	Topical	Kolesnikov et al. (2000)
	Rats	AG	2.0–10	SC	Davis and Perkins (1993), Erichsen et al. (2005), Gades et al. (2000)
	Rats	AG	2.8	SC-L	Smith et al. (2003)
Naloxone hydrochloride (Narcan [®])	Rodents	R	20	IP	Gross (2001), Levine et al. (1986)
Naproxen/hydrocodone	Rats	AG	200 N/1.3	SC	Zelcer et al. (2005)
Oxymorphone (Numorphan [®])	Mice	AG	4	SC-L	Clark et al. (2004)
	Rats	AG	0.03 mg/(kg h) CRI	IV	Gillingham et al. (2001)
	Rats	AG	0.1	IV	Briggs et al. (1995)
	Rats	AG	1.2–1.6	SC-L	Krugner-Higby et al. (2003), Smith et al. (2003)
Physostigmine (Antilirium [®])	Rats	AG	50–200 µg/kg	SC	Poyhia et al. (1999)
Propofol (Rapinovel [®])	Mice	I	26	IV	Cantwell (2001), Flecknell (1993)
	Rats	I	10	IV	Cantwell (2001)
Rocuronium/pentobarbital/urethane	Rats	NMB	12–19 nmol/(kg min) R CRI/30 P/900 U	IV	Epemolu et al. (2003)
Sevoflurane (Ultane [®])	Rats	A	2–2.4%	Inhaled	Pape et al. (2006), Payne et al. (2005)
Sodium pentobarbital (Nembutal [®])	Mice	A	30–90	IP	Flecknell (1993), Gardner et al. (1995)
	Rats	A	30–60	IP	Rao (1990), Wixson et al. (1987a–d)
Succinylcholine (Anectine [®])/urethane	Rats	NMB	1.0 bolus S/1.2 g/kg U repeated boluses	IV	Mishra and Ramzan (1992b, 1993c)
	Rats	NMB	10–50 µg/(kg min) CRI/ 1.2 g/kg repeated boluses	IV	Mishra and Ramzan (1992b, 1993c), Rana and Ramzan (1995)
Tiletamine/zolazepam (Telazol [®])	Rats	A	20–40	IP	Ferrari et al. (2005), Silverman et al. (1983), Wilson et al. (1992)
Thiobarbital [5-ethyl-5-(1-methylpropyl)-2-thiobarbiturate](Inactin [®])	Mice	A	80	IP	Buelke-Sam et al. (1978)
Tizanidine (Zanaflex [®])	Mice	AG	0.25–1.0	PO	Jain et al. (2002)
Tizanidine or clonidine/nimesulide	Mice	AG	0.25 T/1.0	PO	Jain et al. (2002)
Tramadol (Zydol [®] , Ultram [®])	Mice	AG	20–40	IP	Erhan et al. (2005)
Tribromoethanol (Avertin [®])	Mice	A	0.015–0.017 ml of a 0.5% TBE/g body weight	IP	Bagis et al. (2004), Chu et al. (2006), Kiatchoosakun et al. (2001), Papaioannou and Fox (1993), Weiss and Zimmermann (1999)
	Mice	A	125–300	IP	Flecknell (1993)
Tribromoethanol/medetomidine	Rats	A	150 T/0.5 (reversal 2.5 mg/kg atipamezole)	IP	Gopalan et al. (2005)
Vecuronium/fentanyl	Rats	NMB	1.5 bolus/7.5 mg/(kg h) CRI	IV	Bohrer et al. (1994)
Vecuronium/isoflurane	Rats	NMB	0.15–0.19 bolus V then 5.0 mg/(kg h) V CRI/1.25 MAC I	IV	Shin et al. (1992)
Vecuronium/pentobarbital/urethane	Rats	NMB	0.3 or 2.25 V/40 P/500 U	IV, IM	Sunaga et al. (2006)
Vecuronium/sevoflurane	Rats	NMB	0.15–0.19 bolus V then 2.0 mg/(kg h) CRI/1.25 MAC S	IV	Shin et al. (1992)

A, anesthetic; AG, analgesic; I, induction agent; LA, local anesthetic; NMB, neuromuscular blockade; PA, preanesthetic; R, reversal agent; SC-L, subcutaneous in liposomes; TA, topical anesthetic.

TABLE 10-2
BEHAVIORAL AND CLINICAL SIGNS OF PAIN IN RODENTS

Behavioral and clinical signs	Species	References
Mild signs		
Lack of grooming	Rat	Colpaert (1987), Kirsch et al. (2002)
	Rodent	ILAR (1992, 2003)
Mild porphyrin staining	Rat	Gillingham et al. (2001)
Weight loss of <5%	Rat	Kirsch et al. (2002)
	Rodent	Flecknell (1996)
Minor depression	Rat	Kirsch et al. (2002)
	Rodent	ILAR (1992)
Quiet, but mobile after slight stimulation	Rat	Gillingham et al. (2001)
Moderate signs		
Roughened haircoat, piloerection	Rat	Gillingham et al. (2001), Kirsch et al. (2002)
	Rodent	ILAR (1992, 2003)
Porphyrin staining of nose and eyes	Rat	Gillingham et al. (2001), ILAR (2003), Kirsch et al. (2002)
	Rodent	ILAR (1992)
Decreased food consumption	Rat	Colpaert (1987), Kirsch et al. (2002)
	Rodent	Flecknell (1996), ILAR (1992, 2003)
Increased or decreased water intake	Rat	ILAR (2003), Kirsch et al. (2002)
Weight loss 10–15%	Rat	Colpaert (1987), Flecknell (1996), Kirsch et al. (2002)
Hunched posture, sitting	Rat	Gillingham et al. (2001)
Less mobile and alert, responsive only after moderate stimulation	Rat	Colpaert (1987), Kirsch et al. (2002), Roughan and Flecknell (2003)
	Rodent	ILAR (2003)
Eyes closed or squinted	Rat	Gillingham et al. (2001)
Hypothermia, body temperature (BT) reduced 1–2°C	Rat	Kirsch et al. (2002)
Tachypnea, increased 30% over baseline	Rat	Colpaert (1987), ILAR (2003), Kirsch et al. (2002)
Shallow respirations, abdominal component	Rat	ILAR (2003), Kirsch et al. (2002)
Guarding potentially painful site	Rat	Kirsch et al. (2002)
Licking or scratching of potentially painful site	Rodent	ILAR (1992, 2003)
	Rat	Roughan and Flecknell (2001, 2003)
Twitching, tremors	Rat	ILAR (2003), Kirsch et al. (2002), Roughan and Flecknell (2001, 2003)
	Mouse	Wright-Williams et al. (2006)
Lameness	Rat	Kirsch et al. (2002)
	Mouse	Wright-Williams et al. (2006)
More aggressive or more docile	Rat	Kirsch et al. (2002)
	Rodent	ILAR (1992, 2003)
Agitation, restlessness	Rat	Gillingham et al. (2001), Kirsch et al. (2002)
Pica, chewing on cage	Rat	Gillingham et al. (2001)
	Rodent	ILAR (1992)
Severe signs		
Very roughened haircoat, ungroomed	Rat	Colpaert (1987), Gillingham et al. (2001), Kirsch et al. (2002), ILAR (2003)
Severe porphyrin staining	Rat	Gillingham et al. (2001)
Inappetent	Rat	Kirsch et al. (2002)
	Rodent	Flecknell (1996), ILAR (1992), Newton et al. (1975)
Weight loss 20%	Rat	Colpaert (1987), Flecknell (1996), Kirsch et al. (2002)
Hunched posture, head down	Rat	Colpaert et al. (1982), Gillingham et al. (2001), Kirsch et al. (2002), Roughan and Flecknell (2003)
	Hamster	Laber-Laird et al. (1996)
	Mouse	Wright-Williams et al. (2006)
	Rodent	ILAR (1992, 2003)
Inactive, lying prone	Rat	Gillingham et al. (2001), Kirsch et al. (2002)
	Rodent	ILAR (1992)
Eyes pale, sunken, glazed	Rat	Kirsch et al. (2002)
Dilated pupils	Rat	Kirsch et al. (2002)
	Rodent	ILAR (1992)
Eyes closed or squinted with discharge	Rat	Gillingham et al. (2001)
Profound hypothermia, BT reduced by >2°C	Rat	Kirsch et al. (2002)
Tachypnea, increase by 50%	Rat	Colpaert (1987), ILAR (2003), Kirsch et al. (2002)

(Continued)

TABLE 10-2
(CONTINUED)

Behavioral and clinical signs	Species	References
Markedly reduced breathing frequency	Rat	Kirsch et al. (2002)
	Rodent	ILAR (1992)
Shallow respiration with visible effort	Rat	Kirsch et al. (2002)
	Rodent	ILAR (1992, 2003)
Expiratory grunts	Rat	Kirsch et al. (2002)
	Rodent	ILAR (1992)
Exaggerated guarding of potentially painful area	Rat	Kirsch et al. (2002)
Vocalizations (unsolicited, increased frequency)	Rat	Colpaert et al. (1982), Kirsch et al. (2002)
	Rodent	ILAR (1992)
Abnormal gait, incoordination	Rodent	ILAR (1992, 2003), Roughan and Flecknell (2003)
Exaggerated lameness	Rat	Kirsch et al. (2002)
Exaggerated twitching, tremors, or writhing	Rat	ILAR (2003), Kirsch et al. (2002)
	Mouse	Wright-Williams et al. (2006)
Unresponsive to external stimuli	Rat	Gillingham et al. (2001), Kirsch et al. (2002)
Overreacts to external stimuli	Rat	Kirsch et al. (2002)
	Rodent	ILAR (1992)
Bruxism, teeth chattering	Rat	Kirsch et al. (2002)
Ptyalism	Rat	Kirsch et al. (2002)
Self-mutilation	Rat	Gillingham et al. (2001), Kirsch et al. (2002)
	Rodent	ILAR (1992, 2003)
General clinical signs of pain		
Absence of nest building	Rodent	ILAR (2003)
Altered group behaviors (e.g., conspecific grooming, separation)	Rodent	ILAR (1992, 2003)
Altered sleep-wake cycle	Rodent	ILAR (1992)
Cannibalism of offspring	Rodent	ILAR (1992)
Back-arching	Rat	Roughan and Flecknell (2001)
Increased low rearing	Rat	Roughan and Flecknell (2001)
Reduced high rearing, reduced exploring	Rat	Roughan and Flecknell (2001)
Lying with legs crossed	Rat	Roughan and Flecknell (2001)
Stretching	Rat	Roughan and Flecknell (2001)
Unusually quiet (e.g., no startle reflex or stampede)	Guinea pig	ILAR (1992)

Materials in this chapter have been derived in part from the chapter, "Anesthesia and Analgesia in Rodents" in the first edition of *Anesthesia and Analgesia in Laboratory Animals* (Wixson and Smiler, 1997). The first edition also includes a more comprehensive compilation of anesthetic and analgesic agents that are now seldom used, are not available in the United States, or are no longer recommended. The reader is referred to the first edition if this additional information is needed.

II. CONSIDERATIONS IN SELECTION OF ANESTHETICS FOR RODENTS

Every anesthetic affects an animal's physiology as well as its pain perception, and no anesthetic is ideal in all cases. Therefore, the selection of an appropriate anesthetic regimen requires careful consideration of multiple factors to maximize effectiveness

and minimize risks. Considerations of the animal's own characteristics, the intended procedure, and the practicality of available agents all contribute to the choice of analgesics and anesthetics utilized in a given situation.

A. Animal Considerations

Many animal species characteristics may influence the choice or route of administration of anesthetic agents (Borchard et al., 1992; Flecknell, 1987a). The small size of rodents imposes limitations on the volume of an agent that can be administered by a particular route. Table 10-4 lists the amounts of drugs that can be given by various routes in rodent species. Within a species, gender, genotype, age, and other factors such as light cycle can affect response to anesthetic or analgesic agents; strain differences have also been reported (Cole et al., 1990; Cruz et al., 1998; Fagioli et al., 1990; Jauchem and Frei, 1991; Kest et al., 1999; Pavone et al., 1989; Pick et al., 1991; Sonner et al., 1999;

TABLE 10-3

SPECIFIC ANESTHETIC AND ANALGESIC VARIATIONS AMONG MICE AND RATS OF UNIQUE GENETIC BACKGROUNDS

Species	Strain or stock	Model/use	Anesthetic or analgesic agent	Effect of agent on the rodent ^a		
Mouse	129	Transgenic background strain	ACE	Relative insensitivity to acetaminophen analgesia		
			ASP	High sensitivity to aspirin analgesia		
			CLO	High sensitivity to clonidine analgesia		
			IND	High sensitivity to indomethacin analgesia		
			Kappa-agonist	High sensitivity to kappa-agonist analgesia		
			MOR	High sensitivity to morphine analgesia		
			129/J	129Sv	ISO, HAL, DES	Lower MAC than other strains
					MOR	Low sensitivity to morphine analgesia
			A	Cancer, immunology	MOR	Decreased tolerance to chronic morphine administration
					ACE	High sensitivity to acetaminophen analgesia
	ASP	High sensitivity to aspirin analgesia				
	AKR	Cancer, immunology	CLO	High sensitivity to clonidine analgesia		
			IND	High sensitivity to indomethacin analgesia		
			ACE	High sensitivity to acetaminophen analgesia		
			ASP	High sensitivity to aspirin analgesia		
	α – 2KO BALB/c	Absence of α -2 receptors General use	CLO	High sensitivity to clonidine analgesia		
			IND	High sensitivity to indomethacin analgesia		
			MOR	Low sensitivity to morphine analgesia		
			BUP, TRA	Increased analgesia		
			ACE	Relative insensitivity to acetaminophen analgesia		
			ALP	Highly sensitive to alprazolam analgesia		
			ASP	Low sensitivity to aspirin analgesia		
			CLO	High sensitivity to clonidine analgesia		
			ISO	Resists isoflurane-induced bradycardia		
			kappa-agonist	High sensitivity to kappa-agonist analgesia		
	C3H C3H/He	General use	MOR	High sensitivity to morphine analgesia		
			ISO, SEV, DES	Increased respiratory pauses, apnea		
			ACE	High sensitivity to acetaminophen analgesia		
			SP	Intermediate sensitivity to aspirin analgesia		
			CLO	High sensitivity to clonidine analgesia		
			MOR	High sensitivity to morphine analgesia		
	C3H/HeN C3H/J	General use, immunology	ISO	Leukopenia, thrombocytopenia		
			HAL	Higher MAC than other strains		
	C57BL C57BL/10 C57BL/6	General use, immunology	ALP	Insensitive to alprazolam analgesia		
			ISO	Acute porphyria		
			ASP	Intermediate sensitivity to aspirin analgesia		
			ACE	High sensitivity to acetaminophen analgesia		
			CLO	Relative insensitivity to clonidine analgesia		
			IND	High sensitivity to indomethacin analgesia		
			MOR	Relative insensitivity to mu-agonist analgesia		
ACE			High sensitivity to acetaminophen analgesia			
ASP			Intermediate sensitivity to aspirin analgesia			
CLO			Relative insensitivity to clonidine analgesia			
C58	Hearing loss, leukemia	Kappa-agonist	Relative insensitivity to kappa-agonist analgesia			
		MOR	Relative insensitivity to mu-agonist analgesia			
		ISO	Lower MAC than other strains			
		ACE	Relative insensitivity to acetaminophen analgesia			
		ASP	High sensitivity to aspirin analgesia			
		CLO	Relative insensitivity to clonidine analgesia			

Rat	CBA	General use	IND	High sensitivity to indomethacin analgesia
			Kappa-agonist	Relative insensitivity to kappa-agonist analgesia
			MOR	Relative insensitivity to mu-agonist analgesia
			ACE	Relative insensitivity to acetaminophen analgesia
			CLO	High sensitivity to clonidine analgesia
			IND	Low sensitivity to indomethacin analgesia
	CF1	General use	Kappa-agonist	Relative insensitivity to kappa-agonist analgesia
			MOR	High sensitivity to morphine analgesia
			ENF	Acute porphyria
			ACE	Relative insensitivity to acetaminophen analgesia
			ASP	High sensitivity to aspirin analgesia
			CLO	High sensitivity to clonidine analgesia
	DBA/2	General use	EA	Increased analgesia
			IND	High sensitivity to indomethacin analgesia
			Kappa-agonist	High sensitivity to kappa-agonist analgesia
			MOR	High sensitivity to morphine analgesia
			ISO, ENF	Anesthesia resistance
			ISO, SEV, ENF	Anesthesia resistance: ddN > C57BL
	ddN	Corpus callosum agenesis	ISO, HAL	Lower MAC than other strains
	FVB/J	Susceptible to Friend Leukemia Virus B	ISO, HAL	Lower MAC than other strains
	LP/J	Audiogenic seizures, tumors	HAL, DES	Higher MAC than other strains
	NZW	No anti-DNA antibodies	MOR	High sensitivity to morphine analgesia
	PKC- γ KO	Absence of protein kinase C	ISO	Higher MAC than other strains
	Reeler	Increased seizure susceptibility	ISO	Further increased incidence of seizure activity
	RIIS	Factor VIII deficiency	ACE	Relative insensitivity to acetaminophen analgesia
			CLO	Relative insensitivity to clonidine analgesia
Kappa-agonist			High sensitivity to kappa-agonist analgesia	
MOR			High sensitivity to morphine analgesia	
ISO			Further reduction in hippocampal 5-HT	
ISO			Further reduction in hippocampal 5-HT	
Serotonin transporter KO	Reduced hippocampal 5-HT	ISO	Further reduction in hippocampal 5-HT	
	Obesity, atherosclerosis	CLO MOR	Relative insensitivity to clonidine analgesia Low sensitivity to morphine analgesia	
Spret/Ei Fischer 344	<i>Mus spretus</i> General use	MOR	Decreased tolerance to chronic morphine administration	
		ISO, HAL, DES	Higher MAC than other strains	
		HAL	Reduced NK activity	
		MOR	Low sensitivity to morphine analgesia	
		ISO	MAC Lewis < SD	
		MOR	High sensitivity to morphine analgesia	
		BUP	SD has decreased food intake at higher doses (< intake than treated DA)	
		ISO	MAC SD > Lewis	
		MOR	High sensitivity to morphine analgesia	
		ISO, HAL, SEV	Decreased cardiac contractility	
ISO, SEV	Enhanced inhibition of Ang-II vasoconstriction leading to systemic hypotension			
SHR	Spontaneous hypertensive	MOR	Hypotension and bradycardia: SHR > WKY, SD	
		ISO, HAL, SEV	Blunted anesthetic response	
Zucker fa/fa	Obesity	ISO, HAL, ENF, DES	Blunted anesthetic response	

ISO, isoflurane; SEV, sevoflurane; HAL, halothane; DES, desflurane; ENF, enflurane; BUP, buprenorphine; TRA, tramadol; MOR, morphine; EA, electroacupuncture; CLO, clonidine; indomethacin; ASP, aspirin; ALP, alprazolam.

^aEffect of the anesthetic or analgesic is a comparison between a “treated” rodent and an untreated control or between a specific strain or stock and a wild-type control.

TABLE 10-4
VOLUMES AND ROUTES OF ADMINISTRATION BY SPECIES AND SITE

Species	Oral	Subcutaneous	Intraperitoneal	Intramuscular ^a	Intravenous (bolus)	Intravenous (infusion)
Mouse	0.25 (max 1.0)	Scruff 2–3 (<20 G)	2–3 (<21 G)	Quadriceps or caudal thigh 0.05 (<23 G)	Lateral tail vein 0.2 (<25 G)	Max. 25 ml/kg
Rat	3–5 (max. 15)	Scruff or back 5–10 (<20 G)	5–10 (<21 G)	Quadriceps or caudal thigh 0.3 (<21 G)	Lateral tail vein 0.5 (<23 G)	Max. 20 ml/kg
Gerbil	0.5 (max. 1.0)	Scruff 3–4 (<20 G)	3–4 (<21 G)	Quadriceps or caudal thigh 0.1 (<21 G)	Lateral tail vein 0.3 (<25 G)	Max. 25 ml/kg
Hamster	0.5 (max. 1.0)	Scruff 3–4 (<20 G)	3–4 (<21 G)	Quadriceps or caudal thigh 0.1 (<21 G)	Femoral or jugular vein (cut-down) 0.3 (<25 G)	Max. 25 ml/kg
Guinea pig	5–10 (max. 35)	Scruff or back 5–10 (<20 G)	10–15 (<21 G)	Quadriceps or caudal thigh 0.3 (<21 G)	Ear vein or saphenous vein 0.5 (<23 G)	Max. 20 ml/kg

^aValues are in milliliters per site.

G = gauge of needle to be used.

Vaccarino et al., 1988). Genetically modified rodents may have unexpected variability in their response to anesthetics compared with background strains, since the location of inserted genetic material and the number of inserted copies of that genetic material will vary among transgenic animals. Table 10-3 summarizes published instances where genetic background has been shown to influence the effects of anesthetics and analgesics on rodents. Biodistribution of drugs may differ in obese, pregnant, or lean animals, and prior exposure to agents, such as raw pine shavings, that affect hepatic enzymes has been shown to alter the effects of drugs metabolized by this route (Amouzadeh et al., 1989; Borchard et al., 1992; Weichbrod et al., 1988). Pregnant animals require special consideration depending on the stage of pregnancy, whether or not the agent under consideration crosses the placenta, and whether potential effects on the fetus will alter experimental data. While a primary consideration is that animals are anesthetized humanely with as little physiological disturbance as possible, a second important consideration is that the anesthetic to be used should minimally affect research data.

The health status of an individual animal also requires consideration. While it may be impractical to perform a complete physical exam on every rodent, a useful assessment can be made quite quickly. Changes in overall appearance or demeanor, such as skin lesions, masses, or dehydration, or changes in alertness, activity, gait, or body position, may indicate a health problem. A body weight that is significantly less than that of cohorts may be observed in the cage or as the animal is handled, or may be documented by weighing. Body condition scoring, which can be applied to many species, is a quick and effective method to assess overall condition (Easterly et al., 2001; Ullman-Cullere and Foltz, 1999). Respiratory disease may be detected by noisy or rapid breathing or by nasal or ocular discharges and may suggest serious conditions such as pulmonary consolidation due to agents such as *Pneumocystis carinii*. Examination of the quantity, consistency, and color of fecal material and urine in the animal's cage may indicate gastrointestinal or urinary abnormalities. Detection of any potential health issues should initiate closer examination of the individual animal and reassessment

of the anesthetic protocol, associated risks, the planned anesthetic dose, and whether this animal is a suitable subject for the proposed research.

B. Procedure Considerations

The anesthetic regimen must be compatible with the needs and restrictions of the procedure to be performed. Different agents have different durations of effect, so the anticipated length of the procedure must be a primary consideration. It is also essential that contingency plans be in place to ensure continued depth of anesthesia should the procedure last longer than expected. The choice of anesthetics may depend on whether or not the animal is intended to survive the procedure, and the degree of invasiveness of the proposed procedure needs to be anticipated. Scientific goals may require specific physiologic effects such as muscle relaxation or avoidance of cardiac or respiratory disturbances and the anesthetic regimen must be adjusted to provide or avoid these effects (Antunes et al., 2003a; Brown et al., 1989; Stringer and Seligmann, 1996). The anatomical location of the procedure and a requirement for intraoperative restraint, such as the use of stereotaxic surgery or procedures on the eyes, nose, or mouth, may limit the anesthetic options (Yamasaki et al., 2003). The animal may need to be transported while under anesthesia, or may be undergoing a procedure in a location with physical limitations, such as magnetic resonance or other imaging studies, which are addressed elsewhere in this text.

C. Practical Considerations

Any anesthetic choice involves consideration of availability, equipment, training, and expense. Some agents are not available in all countries or locations, and controlled drugs require special licensing and handling. Modern inhalant anesthetics require the use of calibrated vaporizers and gas scavenging systems, while infusion methods may require an infusion pump

for precise control. Recovery support, especially after lengthy procedures, may include a need for heated cages or chambers and supplemental oxygen. Personnel must be trained in procedures such as injection techniques, endotracheal intubation, or vascular access, must be familiar with the use of any equipment required for administration and monitoring, and should also be knowledgeable regarding potential adverse anesthetic effects and appropriate responses.

The number of animals to undergo a procedure on the same day may influence the choice of anesthetics, since rodent anesthesia for groups of rodents is often done as in an assembly line with individual animals proceeding through induction, surgery, and supervised recovery phases. The availability of resources such as a centralized surgery facility and staff with experience in rodent anesthesia may increase the options available for scientists by providing access to drugs, equipment, personnel, and training opportunities. The expense of agents or equipment, technical challenges, and safety considerations may all affect whether a specific agent may be suitable in a given situation.

III. GENERAL ANESTHETIC PLAN

In addition to the selection of the anesthetic regimen, it is important to have a general plan in place that includes animal preparation and postanesthetic recovery. All animals, including rodents, should be observed during recovery until they are able to move around independently. This is especially important for group-housed rodents because each cage group maintains a dominance hierarchy and partially awake rodents may serve as targets for aggression. Anesthesia is a stressful event, independent of any other procedures performed, and alleviating other stressors as much as possible will maximize the animal's overall well-being (Flecknell, 1993a, 1996).

A. Preparation for Anesthesia

Animals that have been recently shipped should be allowed 24–72 hours to recover from the stress of transport. During this time they are also acclimating to changes in their surroundings, which may include the cage environment, feed and water, light cycle, cage mates, noise levels, and handlers. For rodents, pre-anesthetic fasting is generally not needed unless required by the procedure. If necessary, fasting should be minimized due to the high metabolic rate of these small animals. Water should not be withheld. Vomiting during induction and anesthesia is extremely uncommon and the rat is unable to vomit due to the anatomical constraint of the limiting ridge of the forestomach (Luciano and Reale, 1992).

As close as possible to the time of anesthesia, animals should receive at least a brief health assessment as described above.

For injectable anesthetics, it is highly desirable to measure the actual body weight of each animal rather than using a single dose for all animals in a group. Because of their small body size and the small volumes used for injection, it is relatively easy to inadvertently overdose or underdose an individual rodent. This is particularly important in cohorts of older animals, which may have more variation in weight than those at a younger age.

B. Preanesthetic Drugs

In some instances, additional drugs given before or during anesthesia may improve the quality of the anesthesia and/or recovery. The most commonly used premedications are sedatives and analgesics. Sedatives calm the animal, smooth anesthetic induction and recovery, and reduce the dose of anesthetic agent needed, but are seldom used prior to rodent anesthesia due to the additional stress of administering a second injection. Systemic and/or local analgesics may also reduce the anesthetic requirements, and have a preemptive effect on pain perception, which persists into the recovery period (Karas, 2002; Penderis and Franklin, 2005). Other agents that may be used prior to or during anesthesia are anticholinergics, antibiotics, parenteral fluids, supplemental oxygen, and paralytic agents. These are discussed in greater detail in other sections of this chapter.

C. Intraoperative and Recovery Support

Because rodents have a high surface area to body mass ratio, it is extremely important to provide thermal support starting immediately after anesthetic induction and continuing throughout full recovery (Gardner et al., 1995; Wixson et al., 1987c). Body heat is lost rapidly and this loss is accelerated when the fur is clipped and liquid disinfectants are applied. Body heat is also lost if the anesthetized rodent is in contact with conductive surfaces such as metals. Intra- and postoperative thermal support can be accomplished through the use of a heated surgery platform, heating pad, heated chamber or cubicle, or an in-cage heat source such as a sealed container of warm water or nontoxic self-heating chemical warming packs (such as Grabber Mycoal 12+ Hour Pocket Warmers, Grabber Performance Group, Grand Rapids, MI), which can be left in the animal's cage overnight. Animals should be assessed at least daily for signs of pain or distress over the following 24–72 hours and appropriate treatment given. Table 10-2 summarizes the signs of pain seen in rats and mice. In general, since rodents are prey species that have evolved to mask signs of distress, it is better to err on the side of providing analgesics for too long a time than too short. Animals may also require assistance meeting their nutritional and fluid needs. Contingency plans should be in place for treatment or euthanasia of animals experiencing adverse effects from the anesthesia or the procedure.

D. Sequential Surgeries on a Number of Rodents in a Single Session

It is common for surgery to be performed on a number of rodents in the same session, but this practice requires some special considerations. There should be enough people participating in the session to ensure that each animal is adequately observed during induction, anesthesia, and recovery. Injectable anesthetics may be preferred since it is generally not necessary to adjust the dose once given, but this does not preclude the need to monitor depth of anesthesia closely. If the session involves many animals and runs late in the workday, there may be a temptation to return the last animals of the group to their housing area before they are fully recovered. Animals that are not fully awake may be injured by cage mates or may rapidly chill without thermal support. Education of personnel is essential to avoid compromise of animal welfare.

IV. RECOMMENDED ANESTHETIC METHODS FOR ROUTINE USE IN RODENTS

A. Inhalant Anesthetics

Historically, the use of inhalant anesthetics for rodents was limited by deterrents such as small animal size and difficulty of intubation. With the advent of more convenient and cost-effective delivery systems and increased numbers of trained personnel, the ease and frequency of the use of inhalant anesthetics for rodents have increased dramatically over the past decade. Inhalant anesthetics provide a safe, reliable, reversible, and reproducible means of rendering rodents unconscious in order to perform surgeries and other intricate or potentially painful procedures. This section will provide a review of the use of inhalant anesthetics in mice and rats. For more information regarding the pharmacokinetics of anesthetic agents, please refer to the previous edition of this text (Brunson, 1997).

1. Delivery Systems

Inhalants are unique among veterinary anesthetics because the lungs provide the route of both administration and elimination. The two main categories of inhalant anesthetics are volatile agents (isoflurane, sevoflurane, etc.) and nonvolatile gases (e.g., carbon dioxide, nitrous oxide, etc.). While the nonvolatile agents require only a low-pressure connection between the gas supply and the animal, the volatile agents require a precision vaporizer to control the delivery of the agent. With modern vaporizers, the anesthetist can set the combination of air or oxygen to be mixed with the agent and deliver a specific percentage of drug to the patient.

Regardless of the agent or the system, inhalation anesthesia involves the delivery of a volatile compound or a high

concentration of a nonvolatile gas to the rodent via the respiratory tract. The use of a "bell jar" for short-duration anesthesia continues to be popular because the required equipment is inexpensive and readily available. However, this method has several disadvantages: (1) the potential for the rodent to come in contact with the liquid anesthetic, (2) an unmeasured and uncontrolled concentration of the anesthetic, (3) the possibility of inadvertent overdose when using highly volatile agents, and (4) the potential release of volatilized anesthetic to the room air if the jar is not contained in a chemical fume hood. As a result, many institutions have restricted or forbidden the use of bell jars for rodent anesthesia. A refinement to this technique is an "anesthesia box," usually made of Plexiglas and attached to an inhalant vaporizer or gas line and a scavenging system.

Inhalant anesthesia of small rodents is generally maintained utilizing face masks or nosecones, either to a single animal or to a group of animals by use of a manifold connected to a vaporizer. With improved training programs and equipment (Jou et al., 2000; Ordodi et al., 2005), endotracheal intubation has also become a more common practice in mice and rats. Because anesthetic-induced respiratory depression is not uncommon, the anesthetist will often choose to mechanically ventilate the rodent patient. Due to the easily compliant pulmonary system of the rodent, it is possible to ventilate a rodent with a nosecone. Today, there are commercial nosecones designed for rodents, which closely fit the rodent snout and thus minimize the amount of waste gas exiting the cone around the patient-mask interface. Close-fitting "masks" for small rodents can also be easily fashioned out of trimmed latex exam gloves fitted snugly over a mask adapter. Rodents are obligate nasal breathers; therefore, a nosecone is an ideal way to deliver inhalant anesthesia.

Endotracheal intubation of mice and rats is facilitated by equipment and techniques that have been refined and customized for these species (Brown et al., 1999; Jou et al., 2000; Kastl et al., 2004; Linden et al., 2000; Ordodi et al., 2005; Vergari et al., 2003, 2004; Weksler et al., 1994). Endotracheal tubes are most commonly custom-designed from intravenous catheters and polyvinyl cannulae. Depending on the species and technique, visualization of the laryngeal orifice may involve ventral transillumination of the oropharynx (Brown et al., 1999), a customized laryngoscope (Molthen, 2006), or conventional pediatric equipment (Schaefer et al., 1984). Intubation can be accomplished in dorsal recumbency or by using customized or commercially available inclined rodent boards. Similar to other rodent equipment refinements, many manufacturers of mechanical ventilators have specifically designed and calibrated models for use in small rodents.

At times, large numbers of rodents may need to be anesthetized in quick succession to allow for procedures of short duration to be performed humanely and efficiently. Commercially available manifolds requiring only one vaporizer and input of air/oxygen have become much more popular when attached

via nosecones or masks to several rodents undergoing similar experimental surgical procedures.

Scavenging of anesthetic gases is essential to protect laboratory personnel working with animals. In a barrier setting, many rodent procedures are best performed within secondary enclosures such as a cage changing station or a biosafety cabinet (BSC). If this BSC is hard-ducted and exhausts to the outside (Class II, Type B2), then supplemental scavenging is not needed. Otherwise, the exhaust from the induction chamber must be attached either to a wall-mounted vacuum system or to commercial charcoal canisters that remove anesthetic gas from expired and excess anesthetic mixture. Charcoal filtration is not effective for removing nitrous oxide from the anesthetic circuit (Smith and Bolon, 2003). Canisters must be routinely monitored to ensure they do not exceed their scavenging capacity.

Although the most common method for delivery of volatile gas anesthetics is via inhalation, it has been demonstrated that isoflurane can be administered intravenously (IV) when mixed with Intralipid in the mouse (Eger and MacLeod, 1995) and the rat (Zhou et al., 2006).

2. *Advantages of Inhalation Anesthesia*

Over the years, inhalant anesthesia has proven to be safe and reliable in rodents. The most important advantages of inhalant anesthesia are the predictable and rapid control of anesthetic depth and the minimal influence on research data (Wixson and Smiler, 1997). These factors directly relate to increased survival rates and optimal data acquisition from rodent models of biomedical research. Compared with anesthetics administered by injection, the use of inhalant anesthetics offers far more control over the duration and depth of the anesthesia because central nervous system (CNS) depression is rapidly reversed after reduction of delivered anesthetic levels. Because of high gas solubilities in tissues and pulmonary delivery methods, a change in the percentage of inspired volatile gas will result in rapid changes in anesthetic depth. Inhalants are administered “to effect” and within a fairly narrow dosage range (typically 0–5%); thus, dose calculations are not required and dilution or mixing prior to use is not necessary (Brunson, 1997). The use of inhalant anesthetics does not require special licensing and record-keeping because they are not controlled substances. Volatile inhalant anesthetics have profound and specific short-term effects on the CNS, their primary site of action. Their effects on other organ systems vary and will be discussed in the sections on each agent below.

3. *Disadvantages of Inhalation Anesthesia*

The disadvantages to the use of inhalation anesthetics are as follows: (1) induction must be closely monitored, (2) specialized personnel training may be necessary, (3) specialized equipment is needed, and (4) costs associated with training and equipment

are higher than those with the use of injectable anesthetics. The use of volatile anesthetics without effective scavenging can be dangerous for personnel (Paddleford, 1986), but proper training, conscientious application of training techniques, oversight, and the diligent use of fully functional, modern equipment will minimize the occupational exposures.

Anesthetic induction of a rodent with inhalants often requires closer attention than with parenteral anesthetics. Induction doses (e.g., isoflurane 4–5%) are often significantly higher than maintenance doses (e.g., isoflurane 1–3%), and prolonged exposure to these higher percentages may lead to mortality via cardiovascular and respiratory depression. The induction, delivery, and scavenging systems all add to the cost and technical training necessary to provide safe and reliable inhalation anesthesia. Prefabricated induction chambers should exhaust through a carbon filter, a calibrated vacuum system (hard-ducted to the exhaust system), or into a fume hood, vacuum exhaust, or ducted BSC. Even if the induction chamber is attached to a scavenging system, opening the chamber to retrieve the anesthetized rodent releases the vaporized inhalant into the surrounding area. The Occupational Safety and Health Administration (OSHA) and the National Institute for Occupational Safety and Health (NIOSH) have established standards for exposure to unscavenged anesthetics in humans (NIOSH, 1977). Chronic exposure to volatile anesthetics in excess of these limits has led to hepatic, neurologic, renal, and reproductive dysfunction in staff (Rogers, 1986; Smith, 1993). The institution’s occupational health program should define the proper use of inhalant anesthetics by trained personnel [Institute for Laboratory Animal Research (U.S.) (ILAR), 1996].

While the anesthetic monitoring of a rodent requires the same clinical experience as the use of parenteral anesthetics and the maintenance of a stable animal may be simple, intubation of rodents requires training (Vergari et al., 2003). When intubation is performed properly, the rodent will be a more stable patient and there will be very little unscavenged anesthetic gas. Within the last several years, the trend in laboratory animal medicine is the creation or expansion of training programs within animal care units (Kennedy, 2002), so much of the infrastructure necessary to counter this disadvantage is already in place at many institutions.

Improved training is not the only cost related to inhalant anesthesia—an even more direct expense is the equipment itself. Volatile anesthetics such as isoflurane require vaporizers that cost \$1,000 or more per unit. Complete systems to anesthetize a number of rodents may cost several thousand dollars. Fortunately, these are start-up costs and inhalant anesthesia equipment will function well for years with regular servicing. Anesthetic vaporizers should be recalibrated at appropriate intervals to ensure correct dosage.

It is important to note that the significance of the advantages of inhalant anesthetic delivery (safe for the animal patient and easy to adjust anesthetic depth) far outweigh the listed disadvantages. We advocate for the appropriate use of these agents.

4. Volatile Inhalation Agents

The blood:gas partition coefficient of any volatile anesthetic determines the rapidity of induction, how quickly the anesthetist can alter the depth of anesthesia, and how rapidly the animal recovers from anesthesia. The lower the blood:gas coefficient, the more rapidly the induction, adjustment, and recovery will occur. The direct consequence of a lower blood:gas coefficient is that the lung alveolar concentration of the gas (the last step before entering the bloodstream) reaches levels similar to that of inspired gas very quickly. A high ratio of arterial to inspired gas (F_a/F_i) allows for rapid adjustments in depth of anesthesia. The newer gases (e.g., desflurane and sevoflurane) have a lower blood:gas coefficient and higher F_a/F_i ratios, and thus work more rapidly than the more historic agents (e.g., isoflurane and halothane) (Heavner, 2001).

The minimum alveolar concentration (MAC) of a volatile anesthetic is a relative measure of how much delivered gas is necessary to anesthetize the patient (Heavner, 1997). MAC is inversely proportional to the potency of the gas, i.e., anesthetics with a low MAC have a relatively high potency. MAC typically is described as the “effective dose” when 50% of the patients are “anesthetized,” or the ED₅₀. The ED₅₀ equaling 1 MAC generally represents “light” anesthesia. ED₉₅ represents 1.2–1.4 MAC—when 95% of the patients are anesthetized. MAC 2.0 is considered very deep anesthesia and may be fatal (Rampil and King, 1996). Although adequate anesthesia of a patient can be measured in different ways (e.g., loss of righting reflex, unresponsiveness to surgical manipulation), the relative ranking of MAC in volatile anesthetics remains consistent. For inhalants, halothane has the lowest MAC, followed closely by isoflurane and sevoflurane, while desflurane is considerably higher. This relative ranking is true for most animal species (Heavner, 2001).

The primary effects of volatile and gas anesthetics are to produce sedation, amnesia, and/or hypnosis, which can be achieved through different mechanisms. Clinical and physiologic signs of adequate anesthetic depth in rodents include increases in arterial CO₂, eyelid aperture, and pupil diameter and decrease in mean arterial pressure (MAP) and respiratory rate (Steffey et al., 2003). The pharmacology of inhalant anesthetics is detailed in Chapter 3.

The primary negative side effect seen with all volatile anesthetics is an agent-dependent depression of the cardiovascular system resulting in decreased cardiac output, reduced contractility, and systemic hypotension (Rampil and King, 1996). There is some variability among the volatile agents, e.g., halothane creates more profound myocardial depression compared to isoflurane. The development of hypotension in anesthetized rodents may also be affected by rodent genotype. Table 10-3 summarizes the reported influences of genotype and strain on anesthesia and analgesia. For instance, spontaneously hypertensive rats (SHR) have a greater than usual decrease in MAP when anesthetized with isoflurane or sevoflurane (Yu et al., 2004). With prolonged anesthesia, volatile anesthetic agents may also

produce hepatic injury following metabolism by the cytochrome P450 system. This effect is greatest with halothane, and least with desflurane and isoflurane. The breakdown products can elicit an immune response that predicated the hepatic damage (Njoku et al., 1997). These metabolized by-products do not stay in the liver, but will circulate systemically. Because the brain, heart, liver, and kidneys represent a small proportion of the body mass but receive 75% of the blood flow, these organs will be most affected by volatile agents (Rampil and King, 1996).

a. Isoflurane

For procedures where only very short durations of anesthesia are required, isoflurane provides a rapid onset of induction and recovery and raises corticosterone levels to a lesser degree than does anesthesia with carbon dioxide (CO₂) (Altholtz et al., 2006). Overall, isoflurane is used far more often than other inhaled agents and has been shown to be very safe when used appropriately, even for long periods of anesthesia in both mice (Szczensy et al., 2004) and rats (Wood et al., 2001). ***Isoflurane is a preferred anesthetic for all rodents when equipment for gas anesthesia and scavenging is available.***

Isoflurane produces significant alterations in the CNS. Neuroprotection induced by isoflurane is thought to be a consequence of reduced sympathetic activity (Engelhard et al., 1999). At typical anesthetic levels, isoflurane significantly reduces serotonin levels in the hippocampus of mice (Whittington and Virag, 2006) and increases survivability of oxygen- and glucose-deprived hippocampal cells of the rat, an action that decreases with age (Zhan et al., 2006). Isoflurane offers a protective effect on ischemic rat neuronal cells, noted by a reduction of apoptosis, for up to a week after anesthesia (Kawaguchi et al., 2004). Neuroprotection from cerebral ischemia in a perinatal stroke model in neonatal rats anesthetized with isoflurane is thought to be mediated by a reduced expression of inducible nitric oxide synthase, thus producing less oxidative damage in these animals (Zhao and Zuo, 2004). Isoflurane improves survivability in hypoxic neurons of the cortex by attenuating the increase in intracellular calcium (Bickler and Fahlman, 2006). Isoflurane works at sites in the CNS below the level of the brain. It reduces excitatory transmitters released at nociceptive inputs at the level of the dorsal horn of the spinal cord (Haseneder et al., 2004). In rats, isoflurane improves spatial memory following general hypoxia (Bekker et al., 2006).

Isoflurane may be the best inhalant anesthetic agent to be used in rodent models of human traumatic brain injury. While injured rats anesthetized with isoflurane developed a clinically relevant decrease in MAP, the intracranial pressure did not change (Goren et al., 2001). Not only do injured rats anesthetized with isoflurane have the best cognitive outcome and neuronal survival compared with other common anesthetics (Statler et al., 2006), anesthesia with isoflurane before and immediately after the traumatic brain injury showed no alterations in histopathology

compared with control animals (Statler et al., 2006). This is not true of other volatile inhalant anesthetics.

Isoflurane has protective effects in models of ischemic cardiac disease. If mice are anesthetized with isoflurane and subjected to coronary artery occlusion, the subsequent infarct size is smaller than that in the absence of isoflurane (Tsutsumi et al., 2006b). Cardioprotective effects can last for 2 weeks following the anesthetic episode (Tsutsumi et al., 2006a). A similar effect has been documented in rats (Wakeno-Takahashi et al., 2005). Reduction of the superoxide production and adherence of neutrophils are thought to be the mechanisms of cardioprotection in stroke models (Hu et al., 2003). Compared with a historical, but still commonly used injected anesthetic, pentobarbital, isoflurane produces less deleterious cardiac effects, demonstrated by a higher mean coronary blood flow in rats due to a larger ejection fraction and higher cardiac output (Iltis et al., 2005). In a small number of common strains and stocks of mice (CD-1, Swiss, and C57BL), cardiac output decreased only 5% compared with awake, resting control mice (Janssen et al., 2004). This minimal decrease in cardiac output seen in mice is not seen in rats. Wistar rats anesthetized with 0.9% isoflurane have significantly reduced MAP and perfusion pressure of the brain as compared with rats anesthetized with propofol (Kahveci et al., 2001).

Isoflurane has inconsistent effects in the lung, and can be both protective and deleterious in effect. At the cellular level, isoflurane causes a significant ciliary dysfunction of rat trachea epithelial cells at normal anesthetic doses (Matsuura et al., 2006). Anesthesia with isoflurane worsens the sequelae in patients with neurogenic pulmonary edema, a trait linked to the excessive release of endothelial growth factor from bronchial cells in rats (Kandatsu et al., 2005). Long-term exposure of rats to isoflurane inhibits the release of inflammatory cytokines by the pulmonary epithelium (Giraud et al., 2003). Isoflurane has protective effects on the vascular endothelium when rats are anesthetized before lipopolysaccharide (LPS) administration. LPS-induced vasodilation and subsequent drop in MAP, increase in tumor necrosis factor- α (TNF- α), and direct vascular damage can all be attenuated by prior exposure of rats to isoflurane (Plachinta et al., 2003).

Isoflurane is only minimally metabolized by the liver; therefore, adverse hepatic effects are uncommon following short-to-moderate duration anesthesia. Rats can be anesthetized for short periods of time with isoflurane without any change in the activity of cytochrome P450 enzymes (Plate et al., 2005). Compared to the cardiovascular and nervous systems, the gastrointestinal system is generally spared of side effects of anesthesia with volatile agents. However, rats briefly anesthetized with isoflurane demonstrate a 50% reduction in gut motility for up to 2 hours (Torjman et al., 2005). Another important consideration is the use of anesthesia for hematologic measurements. C3H/HeN mice have been shown to develop a leukopenia, neutropenia, and thrombocytopenia within 48 hours following only 30 minutes of isoflurane anesthesia (Jacobsen et al., 2004).

Isoflurane may be safely used in pregnant or neonatal rodents and can be recommended for embryo transfer (ET) procedures (Smith et al., 2004). Exposure of pregnant ICR mice to isoflurane in the first gestational week produces slight growth retardation in preterm fetuses (Haque et al., 2004). Caesarian-derived pups of pregnant rats administered 2.5% isoflurane have more physiologically normal levels of lactate, pO_2 , and pCO_2 than those at higher doses of isoflurane (Vaillancourt et al., 1999). Isoflurane produces hypoglycemia and metabolic acidosis in neonatal mice. Mechanical ventilation greatly improves the survivability in neonatal mice over spontaneous breathing when exposed to long anesthetic regimens (Loepke et al., 2006). Despite these physiologic effects, isoflurane is generally safe to use in neonatal mice (Drobac et al., 2004; Gotoh et al., 2004) and can be recommended for brief procedures such as tail biopsy for genotyping or toe clipping for identification.

The specific effects of isoflurane on DNA and gene expression are inconsistent. Although isoflurane has been shown to offer protection of the brain and heart following hypoxia to anoxia, normal anesthetic doses of isoflurane can produce oxidative DNA damage in lymphocytes, spleen, and bone marrow of rats as well as brain, liver, and lung tissue (Kim et al., 2006). Conversely, in rat neuronal cultures, exposure to isoflurane upregulates protective genes and downregulates damaging genes (Huang and Zuo, 2005). Isoflurane has been shown to alter the expression of hundreds of genes in the rat brain as detected by gene microarrays (Rampil et al., 2006).

Isoflurane and other volatile agents may have a hyperalgesic effect if the inhaled concentration becomes too low. In rats recovering from anesthesia, a concentration of 0.5 MAC is high enough to produce an antinociceptive effect, while 0.1–0.2 MAC produces hyperalgesia (Flood et al., 2002; Zhang et al., 2000). Therefore, it is of great importance to have completed all painful procedures prior to lowering the dose of isoflurane and beginning recovery of the rodent. It is also recommended that perioperative analgesics be administered well before the patient begins recovering from isoflurane anesthesia.

b. Halothane

Of all the volatile inhalants, halothane has been shown to have the most extensive effects on the cardiopulmonary system during anesthesia. At therapeutic levels, it is a strong hypotensive agent and is known to be arrhythmogenic (Rampil and King, 1996). Most cardiophysiological parameters are impacted adversely in rodent hearts exposed to halothane compared with other inhalant anesthetics (Skeehan et al., 1995). Halothane is the most potent bronchodilator (Klide and Aviado, 1967), and thus may be the best choice for rodent models that may be prone to airway resistance. As newer, safer volatile anesthetics become more easily available and affordable, the use of halothane is expected to decrease. Currently, halothane has very limited availability, with all North American and European manufacturing discontinued.

In halothane-anesthetized rats and mice, albino animals are spared from retinal photoreceptor degeneration produced by prolonged exposure to high-intensity white light (Keller et al., 2001). Like isoflurane, halothane affects dopamine metabolism at presynaptic sites (Adachi et al., 2005). Exposure to about 0.1 MAC of halothane significantly enhances memory of aversive stimuli in rats (Alkire et al., 2005). Halothane also has neuroprotective effects, most notably in reducing the pathology seen with cerebral ischemia (Sarraf-Yazdi et al., 1999). Experimentally, halothane in combination with nitrous oxide provides a significantly increased access of the West Nile virus to the CNS in mice resulting in more cases of fatal encephalitis than in CO₂-anesthetized control mice (Ben-Nathan et al., 2000; Katz et al., 2002).

As few as three halothane anesthetic episodes have been shown to cause fatty change in the livers of CBI mice (Puig et al., 1999). In addition to fatty change, mitochondrial swelling, ribosome depletion, and fragmentation of the endoplasmic reticulum of hepatocytes can be seen in rats subjected to 1.5% halothane (Noseworthy et al., 1997). Similarly, hemorrhagic shock of the liver in rats anesthetized with halothane produced a slower ATP recovery rate than that in rats anesthetized with isoflurane (Takahashi et al., 1997). However, surgical liver insults do not affect high-energy phosphate states following halothane anesthesia, as with isoflurane (Mets et al., 1997).

Halothane may have confounding effects on the immune response. In pulmonary epithelium of rats, long periods of halothane exposure inhibit the release of inflammatory cytokines and decrease the recruitment of leukocytes in lung inflammation (Giraud et al., 2000, 2003). Immune-challenged female CBI mice repeatedly exposed to halothane develop increased numbers of circulating plasma cells (Puig et al., 1999), but have reduced numbers of generalized T and B cells (Elena et al., 1997). Length of exposure to halothane has significant effects on survival in a C3H/HeN mouse undergoing cecal ligation and puncture; an intermediate duration of halothane anesthesia (2 hours) has a significantly lower mortality than both very short (15 minutes) and very long (6 hours) exposures to halothane (Imai et al., 1998).

Halothane causes a consistent and sustained elevation in corticosterone for up to 24 hours, as demonstrated in rats subjected to just one 2-hour anesthetic episode (Karuri et al., 1998). In even briefer anesthetic episodes (30 minutes), halothane acts as a very potent inducer of the stress-related heat shock proteins in the liver, lungs, and kidneys (Kilgore et al., 2003). Heat shock proteins are typically induced in response to various stressors (e.g., hypoxia), but halothane increases the induction of these stress markers over and above the level generally seen in hypoxia alone (Yamasaki et al., 2001).

Halothane may also have reproductive effects. It has been shown to impede development of rat embryos harvested for culture, a side effect not seen with isoflurane (Brown-Woodman et al., 2004). Male rats chronically exposed to halothane exhibit sexual behavior deficiencies, including increased mating

latency and reduced mounting (Oropeza-Hernandez et al., 2002). Furthermore, halothane may reduce pup survival from CBI dams subjected to limited repeated exposures to halothane. Surviving pups demonstrate a reduced general antibody response as neonates and young adult mice (Puig et al., 1999). In pregnant rats, anesthesia with halothane reduces oxytocin-induced uterine contractions (Yamakage et al., 2002); thus, halothane may be considered for anesthesia in cases of cesarean derivation when the pregnant dam must survive to reproduce again.

Despite the significant side effects, halothane can be used effectively in rodents.

c. Sevoflurane

Sevoflurane does have direct cardiodepressive effects, most notably on myocardial contractility, but this effect is similar to that of isoflurane and not severe (Park et al., 1996). Pretreatment with clinically relevant doses of sevoflurane is cardioprotective, similar to many other fluorinated anesthetics (Obal et al., 2001), and is most significant in animals pretreated 48 hours before infarction (Lutz and Liu, 2006) and in septic animals (Serita et al., 2002). This protective effect further extends into the reperfusion phase in these models. Sevoflurane delivered during the first few minutes of reperfusion significantly reduces infarct size, but a longer duration of anesthesia did not further improve the protective effects (Obal et al., 2003).

Sevoflurane appears to have positive effects on the pulmonary system. At normal anesthetic doses, sevoflurane does not produce ciliary dysfunction of rat tracheal epithelial cells (Matsuura et al., 2006). In cases of neurogenic pulmonary edema, sevoflurane does not worsen and may improve overall outcome (Kandatsu et al., 2005). Furthermore, sevoflurane induces an epithelium-dependent bronchodilation (Park et al., 1998), which may improve both anesthetic and oxygen delivery to patients with pulmonary compromise.

Ischemia-induced cerebral apoptosis is reduced if rats are anesthetized with sevoflurane (Pape et al., 2006). General neuroprotection from preconditioning occurs whether sevoflurane is inhaled minutes to days before an ischemic event (Payne et al., 2005). When compared with isoflurane, the most widely used anesthetic in neurophysiology, sevoflurane offers similar rates of rebuilding of high-energy phosphate stores following cerebral ischemia in rats (Payne et al., 2005). Sevoflurane does not have the same neuroprotective effects in experimental spinal cord ischemia in rats (Zvara et al., 2006). Behaviorally, exposure to about 0.1 MAC of sevoflurane significantly enhances memory of aversive stimuli in the rat (Alkire et al., 2005).

As seen in mice anesthetized with halothane, repeated anesthesia with sevoflurane has been shown to produce a peripheral leukopenia and lymphopenia that can persist for several days (Elena et al., 2003).

On a cellular level, sevoflurane inhibits oxytocin-induced contractions of the pregnant myometrium at normal anesthetic

doses (Gultekin et al., 2006; Yamakage et al., 2002). This effect, combined with other positive physiologic effects of sevoflurane, could be useful in improving the success rate of cesarean sections in rodents. Adolescent rats require a higher MAC of sevoflurane than do young adult rats (Kashimoto et al., 1997).

Despite the very rapid induction, ease of maintenance, and rapid recovery of rodents under sevoflurane, the use of this agent has decreased dramatically since the discovery of "Compound A" (fluoromethyl-2,2-difluoro-1-trifluoromethyl vinyl ether), a by-product of the interaction between sevoflurane and soda lime. Compound A is nephrotoxic in rats and humans. There is evidence that there may be species differences with regards to the renal metabolism of inhaled Compound A (Kharasch and Jubert, 1999), but it has not been shown to be neurotoxic in clinical situations (Konat et al., 2003). It is also a potent upregulator of genes involved in apoptosis, oxidative injury, the inflammatory response (Kharasch et al., 2006), and the cytochrome P450 system (Sheffels et al., 2004).

An additional deterrent to the use of sevoflurane over other inhalants is its higher cost.

d. Desflurane

Desflurane is infrequently used because of its low boiling point and high cost of use. At 23.5°C, near "room temperature," liquid desflurane vaporizes into its gaseous state. In order to overcome this characteristic, desflurane use requires a highly specialized vaporizer. The lower solubility of desflurane contributes to the much more rapid recovery from anesthesia compared with isoflurane. Because of this characteristic, desflurane has been used in succession at the procedure's end with a more traditional, less expensive maintenance inhalant such as isoflurane, allowing for a rapid transition to a wakeful state. The recovery of rats exposed to isoflurane and then desflurane was nearly as rapid as rats inhaling desflurane alone and much faster than those inhaling isoflurane alone (Gong et al., 1998).

On a cellular level, synaptic activity recovers more quickly in the hippocampus of rats subjected to normal anesthetic doses of desflurane (Dimalculangan et al., 2006). Neuroprotection induced by desflurane is greater than that induced by halothane, and is thought to be a consequence of reduced sympathetic activity in the CNS (Engelhard et al., 1999).

Like other volatile anesthetics, clinically relevant concentrations of desflurane used to pretreat rats before myocardial infarctions reduced the overall infarction size. Unlike other anesthetics, desflurane produces this effect if administered during the infarction procedure and even following the procedure, potentially serving as a treatment for myocardial infarction (Haelewyn et al., 2004). Like sevoflurane, desflurane acts on the bronchiolar epithelium of rats, producing bronchodilation. This effect may improve both anesthetic and oxygen delivery to pulmonary-compromised patients (Park et al., 1998).

Like sevoflurane, the required MAC of desflurane is inversely related to the age of the anesthetized rodent, with neonatal rats requiring a much higher MAC than adults (Fang et al., 1997).

e. Methoxyflurane

Methoxyflurane is the most soluble volatile agent in the blood and brain, and thus the most potent inhalant. Historically, it was the most commonly used volatile anesthetic for induction of rodents in a bell jar because it reaches a maximum concentration of 3% and therefore does not produce fatalities due to overdose. Currently, methoxyflurane has very limited availability, with all North American and European manufacturing discontinued.

Although it is slower than halothane or isoflurane to produce effect in other species, methoxyflurane has a very rapid and consistent induction time in mice (Gardner et al., 1995). Methoxyflurane is very effective in neonatal rodents and has been shown to be as safe and effective as anesthesia by hypothermia (Danneman and Mandrell, 1997). Methoxyflurane has a profound effect on hormone release. In the hypothalamus–pituitary–adrenal (HPA) gland axis, both ACTH and corticosterone are elevated by methoxyflurane exposure (Karuri et al., 1998). In the absence of any perturbation of serum calcium levels, anesthesia of rats with methoxyflurane produces a significant increase in parathyroid hormone levels (Schultz et al., 1995).

f. Enflurane

As with isoflurane and halothane, long-term exposure of rats to enflurane produces an inhibitory effect on the release of inflammatory cytokines secreted by the pulmonary epithelium (Giraud et al., 2003). Enflurane has a lower margin of safety in rats compared with agents such as isoflurane; therefore, the use of this inhalant in rodents is not recommended. The apneic index (AI)—the multiple of MAC at which an anesthetized patient ceases spontaneous respirations—is less than the MAC for rats anesthetized with enflurane; thus, the rodent ceases to breathe spontaneously before it is fully anesthetized (Rampil and King, 1996). In comparison, the AI is about 2 MAC or more for other volatile anesthetics.

Enflurane has action both in the higher cortex and in the lower spinal cord. Like other volatile anesthetics, enflurane administered after training experiments improved spatial memory in mice (Komatsu et al., 1998). Of all the volatile anesthetics, enflurane is the most epileptogenic, especially in animals already prone to developing seizures. As with isoflurane and halothane, high-energy phosphate status is not affected by enflurane anesthesia in rats subjected to a major surgery (Mets et al., 1997). Most recent use is experimental rather than clinical.

5. *Nonvolatile Inhalation Agents*

a. Carbon dioxide

For decades, CO₂ has been used as a safe form of anesthesia for short-term procedures in rodents as well as a rapid and effective form of euthanasia. CO₂ is typically administered in a chamber or bell jar. Its administration does not require the use of a precision vaporizer; however, because of the narrow margin between anesthesia and euthanasia, animals being anesthetized must be constantly observed during induction and removed promptly from the chamber. It is well documented that CO₂ is highly aversive to both mice and rats (Leach et al., 2002a, 2002b). The aversive effects of CO₂ have been compared to those of other inhalation anesthetics. Anesthesia using CO₂ produces an increase in corticosterone release in rats, an effect that is cumulative with repeated exposure (Altholtz et al., 2006). This increase appears to be the result of ACTH release, especially when combined with an event thought to induce stress (Vahl et al., 2005). Despite these limitations, induction and recovery from CO₂ have been noted to be smooth and CO₂ has been considered acceptable for short-term procedures in rodents (Kohler et al., 1999). Recovery proceeds rapidly after cessation of CO₂ exposure.

b. Nitrous oxide

Nitrous oxide was among the first inhalant anesthetic gases used in a clinical setting in the early 19th century. It has many desirable characteristics, including low solubility in the blood, low toxicity, and minimal cardiopulmonary depression. However, since its anesthetic properties are insufficient for surgical anesthesia, it is most often used as a supplemental inhalant gas anesthetic. It is seldom used in rodents (Goto et al., 1996; Zhang et al., 2000).

c. Xenon

Many other gases have been evaluated for their anesthetic or immobilizing potential with little success. Induction of convulsions and the necessity of using hyperbaric conditions (in some cases over 100 atm) limits the usefulness of most other gases (Koblin et al., 1998). Only xenon has been found to have an attainable MAC in normobaric conditions combined with limited side effects.

Xenon's profound neuroprotective effects stem from its antagonism of the *N*-methyl-D-aspartic acid (NMDA) receptor (Watkins and Jane, 2006), which is implicated in neuronal damage (Wilhelm et al., 2002). Like many other gaseous anesthetics, xenon has cardioprotective (Weber et al., 2005) and neuroprotective (Petzelt et al., 2003) effects if animals are pretreated with the gas before an ischemic episode. In addition, xenon was shown to provide short-term neuroprotection when administered after an episode of hypoxia in neonatal rats (Dingley et al., 2006). Thus, xenon may actually be an effective treatment

for cerebral ischemia under some circumstances. When used for anesthesia in rats, xenon may potentiate gas emboli formation in procedures involving cardiopulmonary bypass, which can impair motor performance and cognition (Jungwirth et al., 2006).

6. *Inhalant Combinations and Supplemental Agents*

By combining an inhalant with another anesthetic, analgesic, or sedative, the overall safety and efficacy of the anesthetic protocol can be improved. Volatile agents can be combined (e.g., isoflurane followed by desflurane) with or without the addition of other inhalants such as nitrous oxide. Inhalant anesthesia can be supplemented with intravenous or intrathecal administration of parenteral drugs (e.g., fentanyl). Other agents with otherwise minimal antinociceptive effects alone can improve the effects of the volatile inhalants. For example, intrathecal administration of midazolam will potentiate the analgesic effects of isoflurane (Taira et al., 2000). Care must be taken during the selection of drug combinations and doses should be reduced in order to minimize side effects. For instance, sevoflurane and isoflurane potentiate seizure and arrhythmia activity in rats given concurrent high doses of intravenous bupivacaine (Dwyer et al., 1994).

In summary, volatile and other gas anesthetics can be extremely useful in rodent models. As with any other method of anesthesia, there may be undesirable side effects or potentially confounding variables; thus, a method must be chosen that protects the health and welfare of the animal while maintaining minimal impact on the research.

B. *Injectable Anesthetics*

1. *General Considerations in the Use of Injectable Anesthetics in Rodents*

Injectable anesthetics are commonly preferred over inhalant anesthetics, particularly for short-term anesthesia, because of ease of use. In cases when inhalant administration would physically interfere with the work being performed (e.g., surgery of the head or mouth) or when inhalant equipment, or staff trained in its use, is unavailable, injectables can be administered readily. Injectable anesthetics require only a needle (23–25 gauge), syringe, and the appropriate training to give a simple injection in a defined anatomic location (Flecknell, 1993). Injectable agents also more easily allow a number of animals to be maintained under anesthesia at the same time. Longer periods of anesthesia can be accomplished by repeated injections or by continuous infusion methods (Hall et al., 2001a). When using parenteral anesthetics, it is important to consider accurate dosing with correct multidrug use ratios, storage conditions, and feasibility of immediate use following reconstitution. It is critical to weigh each animal accurately prior to administration of

a calculated dose of anesthesia to avoid over- or underdosing. Injectables in rodents are usually administered intraperitoneally (IP); however, in larger species (e.g., adult rats, guinea pigs) anesthetics may be administered intramuscularly (IM) or intravenously (IV). Both the volume administered and the gauge of needle used for administration should be considered, particularly for the IM route. Table 10-4 gives guidance for appropriate routes, volumes, and needle gauges for various rodent species.

When drugs are given by injection, the dosage cannot be reduced after induction. Therefore, drugs either at a low dose or with a wide safety margin should be used. Subcutaneous (SC) administration of anesthetics is not recommended because the induction of anesthesia is prolonged and variable in onset. Intravenous injections in rodents can be performed by more highly trained personnel. For most purposes, general anesthesia in rodents is preferred to localized anesthesia because it is believed to reduce stress to the animal and increase safety for personnel (Hall et al., 2001b).

Many small mammals become distressed by handling, subsequently increasing the risk of injury and adverse physiologic effects that might lead to complications while under anesthesia. Risk of injury is considerably reduced by proper handling by trained personnel. To further reduce stress, it is recommended to use appropriate mechanical restraint devices for obtaining accurate body weight measurements. Small mammals require an almost continuous supply of food and water; accordingly, fasting and water deprivation should be minimized prior to anesthetic induction.

Multimodal treatment is the most common approach to administration of anesthetics and analgesics in laboratory rodents. As the mechanism of action of these drugs varies, depending on target sites and receptors within the central and peripheral pain pathways, the overall doses of individual drugs used in combination can often be decreased to reduce the occurrence of side effects (Robertson, 2001). A considerable increase in the use of injectable anesthetic combinations compared to single injected agents has been documented (Richardson and Flecknell, 2005). Most injectable and inhalant agents are not advised for use in neonatal rodents. Anesthesia for neonatal rodents is discussed briefly later in this chapter and in detail in Chapter 27.

2. Dissociative Anesthetics

a. Ketamine

Ketamine combinations, usually with xylazine or xylazine plus acepromazine, are a preferred anesthetic when the equipment for inhalant anesthesia is not available. Ketamine (Ketaset[®]) is a noncompetitive NMDA receptor antagonist that can prevent central sensitization and provide analgesia in the face of ischemic and somatic pain (Robertson, 2001). High doses of ketamine produce dissociative anesthesia and behavioral effects that limit its usefulness as a primary anesthetic

agent. Ketamine does not lead to muscle relaxation, and tonic-clonic spasms of limb muscles may occur even in the absence of surgical or other stimulation. The absence of muscle relaxation makes ketamine a poor choice as the sole anesthetic for intraabdominal surgery. Although dilute single doses are short acting, they effectively produce sedation rather than classic ketamine-induced hallucinatory behavior. Salivation is increased and secretions can obstruct the airways, although laryngeal and pharyngeal reflexes are retained. Ketamine can induce a rise in arterial pressure, usually measured as hypertension in rodents. Ketamine, like most anesthetic agents, is broken down into metabolites in the liver prior to urinary excretion. In most rodents, ketamine as a sole anesthetic is regarded as a poor anesthetic and analgesic (Flecknell, 1987b). Incremental additional doses of ketamine can be given to extend the period of anesthesia but can cause severe respiratory depression (Flecknell, 1987b). Reports have also shown that repeated administration of ketamine in neonatal rats can result in neuronal degeneration (Hayashi et al., 2002). Another disadvantage of ketamine is the occasional production of apneustic ventilation, a pattern characterized by a prolonged pause after inspiration. Due to its status as a controlled substance, ketamine procurement and usage require controlled substance registration, careful documentation, and secure storage.

Despite these disadvantages, ketamine remains the drug of choice for injectable anesthesia when combined with other agents. Ketamine is used preferentially due to its (1) ease of IP administration; (2) relative safety among injectable agents; (3) ability to produce a cataleptic state characterized by CNS excitement rather than depression, along with analgesia, immobility, dissociation from the environment, and amnesia; and (4) complementary properties with adjuvant agents, allowing for a decrease in the amount of general anesthetic needed. To eliminate side effects, a variety of other compounds, both injectables and inhalants, are typically administered along with ketamine (Hall et al., 2001b). Ketamine combinations are the first choice for injectable rodent anesthesia and it is expected that the use of ketamine, in combination with xylazine or medetomidine, will continue to increase in the future (Richardson and Flecknell, 2005).

b. Ketamine combined with xylazine

Xylazine (Rompun[®]) is an α -2 adrenergic agonist used most often to produce chemical restraint. Although rarely used alone, it can produce sedation and muscle relaxation. This drug sensitizes the myocardium to catecholamines and may elicit significant bradycardia and sinoatrial block, which is atropine sensitive. Although atropine is commonly administered to larger species prior to administration of xylazine, this is unnecessary in rodents. Xylazine does have analgesic properties and potentiates many general anesthetics. In rats, xylazine may cause transient hyperglycemia (Hsu et al., 1986), yet contrasting observations indicate that hypoglycemia may be noted

with prolonged administration of ketamine/xylazine anesthesia (Simpson, 1997).

When administering xylazine, cardiac output may decrease due to bradycardia and increased peripheral vascular resistance. Blood pressure may increase slightly due to vasoconstriction, followed by hypotension. The effects on the pulmonary system are somewhat variable, but the overall depressant effects are due to effects on respiratory centers that may lead to respiratory acidosis (Muir and Hubbell, 1989).

A significant advantage of xylazine is its ability to be reversed by specific antagonists, including yohimbine, tolazoline, atipamezole, and idazoxan (Wixson and Smiler, 1997). If reversal agents are used, both the anesthetic and analgesic properties of xylazine are terminated and thus alternative sources of analgesia must be provided. Ketamine/xylazine combinations are a valuable anesthetic combination for long-term procedures and for use in rats undergoing imaging procedures, reducing mobility and allowing calm restraint while maintaining spontaneous ventilation (Simpson, 1997). In mice undergoing hypophysectomy, ketamine/xylazine has been used successfully as a preanesthetic followed by maintenance on vaporized isoflurane (Hoff et al., 2006). When compared to other means of anesthetizing mice for ETs, the administration of ketamine/xylazine resulted in no abdominal lesions following IP administration and more mice were born per litter when compared to mice anesthetized with tribromoethanol (TBE) (Zeller et al., 1998). Ketamine/xylazine also has been effective for anesthetizing pregnant mice (Furukawa et al., 1998). Combinations of ketamine/xylazine have a greater potentiating effect on alleviation of noxious stimulus perception in rats, as compared to ketamine/diazepam anesthesia (Wixson et al., 1987d).

Adverse side effects of ketamine plus xylazine must also be considered. Body temperature in rodents may decrease by several degrees following administration of ketamine/xylazine, and this decrease may be exacerbated by increased urination, defecation, and salivation (Wixson and Smiler, 1997; Wixson et al., 1987c). This side effect emphasizes the overwhelming need to minimize hypothermia in rodents undergoing anesthesia (Lin et al., 1978; Simpson, 1997). Profound reductions in rectal and core body temperatures have been noted in rats, demonstrated by a decrease of up to 4°C over 60 minutes of anesthesia (Wixson et al., 1987c). It has been documented that rats anesthetized with ketamine plus xylazine may develop ocular lesions, including keratoconjunctivitis sicca (Kufoy et al., 1989). Irreversible corneal opacities related to mineralization of the anterior limiting membrane and keratinocyte degeneration, despite perioperative eye lubrication, have also been described (Turner and Albassam, 2005). Acute reversible cataracts have been documented in mice and rats, attributable to a side effect of xylazine (Calderone et al., 1986). Corneal opacities are lessened in severity in certain strains of rats that receive yohimbine for reversal of ketamine plus xylazine anesthesia (Turner and Albassam, 2005). Muscle necrosis may occur following IM injections in small rodents; therefore, IP injections are

recommended (Gaertner et al., 1987; Smiler et al., 1990). Neurologically impaired rats may require decreased doses of ketamine/xylazine to obtain steady-state anesthesia, and may have an increased risk for fatal respiratory depression (Dittmar et al., 2004). For assessment of coagulation assays in rats, ketamine/xylazine had an influence on thrombin time when compared to urethane anesthesia (Stringer and Seligmann, 1996).

c. Ketamine combined with medetomidine

Medetomidine (Domitor[®]) is an α -2 adrenoceptor agonist with 10 times greater specificity than xylazine and fewer notable side effects (Virtanen, 1989). Medetomidine alone can be used for deep sedation and analgesia with rapid reversal by its specific antagonist, atipamezole (Antisedan[®]) (Virtanen, 1989). Atipamezole is 200 times more selective for α -2 adrenoceptor receptors than yohimbine (Virtanen, 1989). Medetomidine has been used in combination with the opioids fentanyl (Hu et al., 1992) or sufentanil (Hedenqvist et al., 2000) for reliable and reversible anesthesia in the rat. A main advantage to the use of these two combinations is their reversibility with nalbuphine or butorphanol and atipamezole. Use of the combination of ketamine/medetomidine may cause hyperglycemia and polyuria similar to xylazine.

Ketamine/medetomidine produces restraint for minor procedures in mice, such as retroorbital bleeding, which can be reversed rapidly by atipamezole (Cruz et al., 1998; Taylor et al., 2000). Female mice appear to be more resistant to the effects of this anesthetic combination than male mice (Cruz et al., 1998; Taylor et al., 2000). This combination has also been used for rodents in field studies. With this combination, induction occurred within 1 minute (Hahn et al., 2005). Less muscle tissue inflammation has been observed when medetomidine is combined with ketamine (versus ketamine alone) (Sun et al., 2003) for IM injections in rats, which may be related to the lesser concentration of ketamine used in multimodal treatment. In rats, ketamine/medetomidine anesthesia can be prolonged with the addition of buprenorphine (Hedenqvist et al., 2000). Opposing studies have demonstrated high levels of anesthetic complications and mortality when rats are premedicated with SC buprenorphine 1 hour prior to IP ketamine/medetomidine administration (Roughan et al., 1999).

d. Ketamine combined with diazepam

Diazepam (Valium[®]) is a benzodiazepine that provides sedation and good muscle relaxation, and can potentiate the action of anesthetics and opioid analgesics (Flecknell, 1996). Classically, diazepam has been used as an anticonvulsant and it can be antagonized in rodents by flumazenil (10 mg/kg IP) (Metten et al., 2007).

Minimal cardiovascular effects are observed with ketamine/diazepam combinations, in particular minimal hypotension,

especially when compared to ketamine/xylazine (Wixson et al., 1987b). Respiratory effects are also minimal and may be limited to a slight decrease in breathing rate and tidal volume. Ketamine/diazepam provides only light anesthesia (Flecknell, 1987b) with poor muscle relaxation and a hyperacoustic response in rats at doses of 40 mg/kg ketamine plus 5 mg/kg diazepam. When compared to other multimodal methods of anesthesia, higher mortality has been observed within 15 minutes of induction with a combination at 60–80 mg/kg ketamine/7.5–10 mg/kg diazepam. Diazepam may also potentiate the heat loss known to occur with ketamine (Wixson et al., 1987c).

e. Ketamine combined with promazine or acepromazine

Promazine, when combined with ketamine and aminopentamide hydrogen sulfate, constitutes Ketaset plus[®], which has been documented to produce effective anesthesia in several species. The combination of drugs suppresses the protective reflexes such as coughing and swallowing during anesthesia, which otherwise remain under ketamine anesthesia alone (Mulder, 1978; Mulder and Johnson, 1978). Promazine alone provides CNS depression without marked motor function impairment. The combination is fairly potent and minimal doses can provide sedative effects with minimal impact on cardiovascular or respiratory depression. Dosing of Ketaset plus in rodents is based on the volume of ketamine provided, i.e., 75 mg/kg of body weight (Mulder and Johnson, 1978), and allows 40–50 minutes of anesthesia after IM injection. Ketaset plus is nonreversible, and hypothermia and hypotension may develop with longer durations of anesthesia. In addition, this combination of agents may decrease the seizure threshold in the animal.

The administration of ketamine with acepromazine provides only light anesthesia, which is not sufficient for surgical procedures (Flecknell, 1987b). Instead, the addition of xylazine to the ketamine/acepromazine mixture, given SC, has been shown to induce rapid and long-acting sedation and analgesia in rats and mice (Arras et al., 2001; Welberg et al., 2006). Recovery of rats to presurgical body weight levels, following implantation with carotid catheters under IM ketamine/xylazine/acepromazine anesthesia, was prolonged up to 4 days postsurgery (Lawson et al., 2001).

f. Ketamine combined with butyrophenones

Butyrophenones are neuroleptic agents that include azaperone, droperidol, and haloperidol. Droperidol, when combined with a narcotic (e.g., fentanyl), has not been documented to produce surgical anesthesia in rodents and neonates, but induces respiratory depression (Danneman and Mandrell, 1997). Azaperone is a sedative neuroleptic with anti-shock properties in rodents. When used alone, azaperone provides sedation in mice; however, in rats, it may induce tachypnea (Olson and Renchko, 1988). When combined with

ketamine, azaperone produces a surgical plane of anesthesia in both mice (34.5 mg/ml ketamine/25.4 mg/ml azaperone) and rats (40.5 mg/ml ketamine/23.3 mg/ml azaperone) (Olson and Renchko, 1988). Anesthetic duration is increased with more concentrated doses of anesthesia for this combination.

3. Barbiturate Anesthetics

Along with the dissociatives described above, barbiturates constitute the other major group of injectable agents. Barbiturates and thiobarbiturates act as CNS depressants and cause decreases in blood pressure, body temperature, renal filtration and function, and peripheral vasodilation (Wixson et al., 1987b). The liver is involved in the metabolic breakdown of barbiturates, as for most anesthetic agents.

Barbiturates may have a narrow margin of safety (Flecknell, 1993). Anesthetic duration may be impacted by environmental conditions, such as raw pine bedding, that cause induction of hepatic microsomal enzymes. Due to cumulative effects, barbiturates are not suitable for repeated administration (Flecknell, 1996). One can observe a dose-dependent cardiac and respiratory depression, with prolonged recovery times and predisposition toward hypothermia. Depending on the strain, gender, and body composition of animals, barbiturates will often exhibit effects specific to each individual rodent (Flecknell, 1993). Due to their status as controlled substances, the procurement and usage of barbiturates require controlled substance registration, careful documentation, and secure storage.

a. Pentobarbital

Sodium pentobarbital, also commonly referred to as pentobarbital, pentobarb, or pentobarbitone, is known to have a narrow margin of safety in most animal species. It has been used historically because it provides a surgical plane of anesthesia following IV or IP administration. However, in laboratory rodents, pentobarbital provides minimal analgesic effect independent of the ability of barbiturates to affect consciousness (Brammer et al., 1993; Field et al., 1993). More importantly, the quality of anesthesia provided by pentobarbital is generally regarded as poor (Flecknell, 1996) and the assessment of pedal reflex is a poor indicator of anesthetic depth (Haberham et al., 1999). When compared to neuroleptanalgesics, pentobarbital incurred minimal to no impact on blood glucose levels in rats (Johansen et al., 1994).

Pentobarbital administration has been shown to be more reliable for rats than for mice and provides approximately 60–120 minutes of anesthesia (Wixson et al., 1987a). Higher doses (80 mg/kg IP) in rats have been utilized for carotid catheterization in rats (Lawson et al., 2001). Mice and rats may experience initial hyperexcitability, including hyperalgesia, during the induction phase and upon recovery with this agent (Field

et al., 1993; Wixson et al., 1987d). Significant cardiovascular depression has been noted in pregnant and nonpregnant mice (Furukawa et al., 1998). In contrast, little effect on heart rate has been noted in rats, as compared to anesthesia with other injectable agents (Sage et al., 1985; Wixson et al., 1987b). Hypotension and uncompensated respiratory acidosis have been documented in rats (Field et al., 1993). Sex differences in tolerance have been noted with this agent, in that male rats clear the drug more rapidly than do females (Zambricki and Daley, 2004). A low incidence of irreversible corneal lesions has been noted in rats anesthetized with pentobarbital (Turner and Albassam, 2005).

Pentobarbital can be combined with other anesthetic agents, in particular medetomidine and tiletamine/zolazepam (Telazol[®]), for long-term anesthesia in rats (Ferrari et al., 2005). Rats that received pentobarbital 1 hour after buprenorphine had longer sleep times and longer durations of surgical anesthesia when compared to ketamine/xylazine (Roughan et al., 1999). Due to the decreasing availability of pentobarbital in the United Kingdom, the United States, and elsewhere, it is anticipated that the use of this agent will decline in the future (Richardson and Flecknell, 2005).

b. Thiobarbital (Inactin)

Thiobarbital [5-ethyl-5-(1-methyl propyl)-2-thiobarbiturate] (Inactin[®]) induces anesthesia of longer duration than pentobarbital. Stable anesthesia for 3 hours has been documented in rats. Administration of additional anesthetic boluses, typically given by the IP route, may be necessary for anesthesia of longer duration. This agent is most useful when a long anesthetic period is needed; however, redosing (in rats) using higher than published doses may be needed to maintain the absence of pedal withdrawal reflexes (Brammer et al., 1993). Thiobarbital, like pentobarbital, has variable analgesic activity (Brammer et al., 1993; Flecknell, 1996) and may impact liver function (Nemeth et al., 1985).

c. Thiopental

Thiopental, also referred to as thiopentone, sodium pentothal, or pentothal, is an ultrashort-acting barbiturate. It is important to administer the lowest possible dose of this potent anesthetic. The agent is highly protein bound and induces a rapid effect, with anesthesia occurring in 20–60 seconds (Muir and Hubbell, 1989). Thiopental usually leads to increases in heart rate due to depression of the vagal center, and significant respiratory depression. Thiopental is most commonly used as an induction agent prior to maintenance of anesthesia with inhalants. This injectable agent is an irritant, primarily because of its high pH level; therefore, it is not advisable to administer thiopental IP to animals in survival procedures (Flecknell, 1996). Overall, it is seldom used in rodents and is only effective when administered by the IV route (Flecknell, 1993).

4. Alkylphenol Derivative: Propofol

Propofol (Rapinovel[®]) was initially marketed in Canada and represents the alkylphenol class of anesthetics (Wixson and Smiler, 1997). This agent is administered IV, with smooth induction, and is rapidly metabolized. The major advantage of propofol is the lack of residual effects following administration. There are no known active metabolites of propofol and 90% of the drug is excreted in the urine as water-soluble by-products. Animals recover rapidly when the infusion is stopped, even if repeated boluses have been given to maintain anesthesia. This quick recovery is important for rodents to avoid complications including hypothermia, dehydration, and prolonged fasting that can accompany postsurgical recovery periods. In rats, mean blood pressures are very stable for up to 3 hours, with 100% survival rates (Brammer et al., 1993). Premedication with other agents may be necessary to sedate rodents prior to IV cannulation for propofol infusion (Brammer et al., 1993; Cantwell, 2001). Target-controlled infusions (TCIs) may be used for IV administrations (Hacker et al., 2005).

Drawbacks to the use of propofol include cardiopulmonary effects due to direct myocardial depression, bolus injection resulting in apnea and hypotension, and the need for careful monitoring to detect changes in the anesthetic depth (Hacker et al., 2005). Premedication with buprenorphine prior to propofol anesthesia in rats resulted in a significant reduction in the total propofol requirement (Penderis and Franklin, 2005). The injection of propofol may be painful in rodents (Brammer et al., 1993). It is recommended that propofol be used within 6 hours of opening a vial to avoid the potential for growth of microorganisms in the anesthetic solution.

5. 2,2,2 Tribromoethanol: Avertin

Tribromoethanol (TBE), formerly sold commercially in the United States as Avertin[®], has been used as a general anesthetic, historically and primarily in the generation of transgenic mice using ET methods. Overall, the anesthesia provided by TBE is relatively inexpensive and safe, with minimal cardiodepressive effects when compared to other agents. TBE is administered IP and provides rapid induction and recovery, loss of reflex activity, good muscle relaxation, and low mortality (Papaioannou and Fox, 1993; Silverman et al., 2003; Weiss and Zimmermann, 1999; Zeller et al., 1998). TBE can lower blood pressures and respiratory rates in anesthetized animals. It is not a controlled substance, and therefore administrative documentation is minimized. Due to numerous reports of animal welfare concerns following TBE anesthesia (see below), TBE is used less commonly than anesthetic combinations with ketamine.

Common doses used for ET and echocardiographic procedures are listed in Table 10-1 (Bagis et al., 2004; Chu et al., 2006; Kiatchoosakun et al., 2001; Weiss and Zimmermann, 1999). TBE has been combined safely with medetomidine, which can then be reversed by atipamezole in rats (Gopalan et al., 2005).

TBE can have rapid and adverse effects on liver and splenic function following IP administration (Thompson et al., 2002).

This anesthetic has been linked to animal health issues related to complications with the reconstituted solution. It is recommended that reconstituted solution be used within 2 weeks of thawing because temperature increases or exposure to light can increase the chance of product breakdown (Buetow et al., 1999). TBE does not have a pharmaceutical-grade formulation; therefore, the reconstitution of chemical-grade TBE may result in formulation errors that could lead to inaccurate dosing in laboratory animals. Animals may have adverse reactions to the toxic by-products, including dibromoacetaldehyde, resulting in acute inflammatory changes, local irritation, fibrous adhesions in the abdominal cavity, and mortality following one or repeated IP applications (Buetow et al., 1999; Lieggi et al., 2005a, 2005b; Norris and Turner, 1983; Zeller et al., 1998). TBE is replaced with inhalant anesthesia for routine procedures (Chu et al., 2006), and its use is recommended only for acute terminal studies when administered IP (Meyer and Fish, 2005).

To avoid the potential for inflammatory peritoneal lesions secondary to toxic by-products and microorganisms, it is recommended that TBE be dissolved only in tertiary amyl alcohol, and that the anesthetic solution should undergo filtration to ensure sterility prior to administration (Weiss and Zimmermann, 1999). Stock solutions are highly light sensitive and must remain covered (i.e., with foil) during storage to avoid degradation. Appropriate handling and preparation of this chemical-grade agent are imperative for successful and uncomplicated anesthesia in rodents.

6. *Dissociative Agent and Muscle Relaxant: Telazol*

Telazol, a unique combination of dissociative agent (tiletamine hydrochloride) and muscle relaxant (zolazepam hydrochloride), is a nonnarcotic and nonbarbiturate agent. It is short-acting and has characteristics similar to those of ketamine, including the maintenance of a number of reflexes under anesthesia. Persistent cough, swallowing, and corneal and pedal reflexes make it difficult for the anesthetist to assess the depth of anesthesia. Tiletamine is more potent, yet structurally similar to ketamine, with a longer duration of action. Zolazepam is a benzodiazepine derivative, licensed for use only with tiletamine. It has a rapid onset of action, but lacks analgesic properties (Ferrari et al., 2005) and is used to offset the cataleptic effects of tiletamine.

Telazol produces anesthesia in rats and can be combined with medetomidine, xylazine, or butorphanol to prolong duration of effects (Ferrari et al., 2005; Silverman et al., 1983; Wilson et al., 1992). This anesthetic agent is not recommended for solitary use in mice or hamsters due to difficulties in inducing anesthesia and a very narrow margin of safety in these species (Silverman et al., 1983). It is important to note that, as with many agents, higher doses of Telazol result in prolonged recovery times; therefore, laboratory animals should be monitored closely to

ensure a safe recovery when using higher dosages. Due to its status as a schedule III-controlled substance, Telazol procurement and usage require controlled substance registration, careful documentation, and secure storage.

7. *Neuroleptanalgesic Combinations*

Commercially available preparations of neuroleptanalgesics consist of an opioid analgesic and a potent tranquilizer. A particular advantage to these agents is that the effects of the opioid may be reversed using a specific antagonist, like naloxone. This will also result in complete reversal of analgesia produced by the opioid; therefore, buprenorphine can be administered to reverse the respiratory depressant effects of the opioid (i.e., fentanyl) and also provide analgesia into the postoperative period (Flecknell, 1987b). One should be cautious with repeated dosing, which can be detrimental to the animal due to longer duration of action of the tranquilizing agent. Respiratory depression can result in hypercapnia and acidosis.

a. Fentanyl/Fluanisone

Fentanyl/fluanisone, or Hypnorm[®], is the most popular combination of neuroleptanalgesia. Hypnorm is administered IM, yet repeated boluses may not provide additional analgesia (Brammer et al., 1993). Hypnorm is most commonly mixed with benzodiazepines, like midazolam or diazepam, to provide excellent surgical anesthesia for short-term procedures (Flecknell, 1987b; Richardson and Flecknell, 2005). Tachycardia and hypotension may be noted with this combination (Brammer et al., 1993; Flecknell and Mitchell, 1984). Hypnorm/midazolam is recommended as the anesthetic of choice for longitudinal studies of somatosensory-evoked potentials (SEPs) in the rat (Hayton et al., 1999). Low incidence of irreversible corneal lesions has been noted in rats anesthetized with Hypnorm/midazolam (Turner and Albassam, 2005). Attempts to administer a related benzodiazepine, clonazepam, with Hypnorm were confounded by relatively poor anesthesia levels in rats (West and Green, 1987). Hyperglycemia has also been induced in fed (not fasted) rats when placed under Hypnorm anesthesia (Johansen et al., 1994). Despite the popularity of Hypnorm, it is unlikely to be commercially available in the future (Richardson and Flecknell, 2005). Pharmacies in the United States can compound combinations of fentanyl and fluanisone, if desired.

V. DRUGS USED AS ADJUVANTS TO PRIMARY ANESTHETIC AGENTS

Adjuvant agents for anesthesia are agents that are combined with the primary anesthetic agent or agents to gain specific advantages. Such advantages include a reduction in the dose of the primary anesthetic, an increase in the duration of the surgical

plane of anesthesia or muscle relaxation, an increase in the depth of anesthesia, postoperative analgesia, or more rapid recovery from anesthesia. However, there are disadvantages to adding adjuvant agents to the anesthetic regimen. The addition of any drug beyond the primary anesthetic potentially complicates the course of anesthesia for the animal. Since an unanticipated negative reaction is possible with the administration of any drug, each drug added to the regimen increases the possibility of an adverse reaction. The addition of drugs that depress essential functions, such as the cardiovascular and respiratory systems, means that supplemental doses of the primary anesthetic(s) may need to be reduced. The discussion below focuses on the advantages and disadvantages of drugs commonly used as anesthetic adjuvants.

A. Anticholinergics

Anticholinergics such as atropine are seldom utilized in anesthesia of rodents. Their primary uses in anesthesia of larger species are for their parasympatholytic actions of decreased salivation, decreased secretions in the respiratory tract, and prevention of vagus inhibition of the heart (Thurmon et al., 1996a). The need for these actions is much reduced or absent in rodents, eliminating the routine need to use these drugs. Additionally, the rat rapidly metabolizes atropine because it has a hepatic atropine esterase (Thurmon et al., 1996a).

B. α -2 Adrenergic Agonists: Xylazine and Medetomidine

α -2 Adrenergic agonists xylazine (Rompun) and medetomidine (Domitor) are commonly used to supplement the primary anesthetic ketamine (Ketaset) (Flecknell, 1993; Green et al., 1981; Hahn et al., 2005; Hsu et al., 1986; Mulder and Mulder, 1979; Nevalainen et al., 1989; Van Pelt, 1977; Wixson and Smiler, 1997). Most commonly, ketamine and xylazine are mixed together prior to administration and are given by the intraperitoneal (IP) route to avoid muscle necrosis that may result if given by the intramuscular (IM) route. Muscle necrosis is most likely due to the pH of 3 of the ketamine component (Gaertner et al., 1987). These agents are extremely useful in combination with ketamine because they smooth induction, provide analgesia beyond the short period of surgical anesthesia (15–30 minutes), and provide muscle relaxation that is absent if ketamine is given alone. Ketamine/xylazine combinations are the most commonly used injectable combinations for anesthesia of mice, rats, hamsters, and guinea pigs (Branson, 2001; Gilroy and Varga, 1980; Green et al., 1981; Van Pelt, 1977). Ketamine/medetomidine combinations are also recommended (Hu et al., 1992; Taylor et al., 2000). Sedative and analgesic activity are related to CNS depression mediated by stimulation of α -2 receptors, while the muscle-relaxant effect is due to inhibition of intranural transmission of impulses to the CNS

(Gross, 2001; Thurmon et al., 1996b). Xylazine may also be used as a preanesthetic, which reduces the dosage of barbiturate or inhalant primary anesthetic.

An advantage of these drugs is the ability to reverse them once the procedure is completed. Medetomidine can be reversed with atipamezole (Hahn et al., 2005; MacDonald et al., 1989) and xylazine can be partially reversed with yohimbine (Hsu et al., 1986; Lipman et al., 1987), tolazoline, 4-aminopyridine (Komulainen and Olson, 1991), or atipamezole (Flecknell, 1996). Reversal leads to early termination of surgical anesthesia, which may reduce mortality and allow rapid return of the rodents to the home cage environment. Reversal agents also reverse bradycardia, bradypnea, and polyuria, but do not eliminate the hypothermic effects; thus, thermal support remains essential (Komulainen and Olson, 1991).

Disadvantages of the administration of xylazine and medetomidine include transient hyperglycemia, bradycardia, peripheral vasoconstriction, hypothermia, and diuresis; however, these effects are reduced in rodents compared to dogs because xylazine is most commonly administered by the IP route rather than by the IV route. When these agents are used with ketamine and additional anesthetic time is needed, only the ketamine should be re-dosed because of the potential for bradycardia and cardiac arrest. Xylazine should be avoided for studies of cardiac function due to its depressant effect on the heart. It is also contraindicated in studies of muscle function due to a depressant effect on contractility of skeletal muscle (Ingalls et al., 1996). Xylazine has been demonstrated to alter ocular physiology and to cause transient cataracts, although these effects may be due to drying of the cornea, and it may be best to avoid use of xylazine in studies of ocular physiology (Calderone et al., 1986). Xylazine has also been documented to increase gastrointestinal transit time in mice (Hsu, 1982), cause hyperglycemia in the C57/Bl6 inbred strain of mice (Brown et al., 2005), and induce diuresis via decreased release of antidiuretic hormone (Hsu et al., 1986). For further discussion of specific drug combinations, the reader should refer to Section IV.B.

C. Phenothiazine Tranquilizers

Phenothiazine tranquilizers such as acepromazine, chlorpromazine, and promazine are often used in combination with ketamine or in combination with ketamine plus xylazine in mice and rats. Phenothiazines act to depress the brain stem and connections to the cerebral cortex (Gross, 2001). The addition of these tranquilizers improves muscle relaxation and decreases the total dose needed of ketamine or ketamine plus xylazine. Phenothiazine tranquilizers also reduce ventricular arrhythmias and cardiac fibrillation, especially those that are induced by epinephrine (Thurmon et al., 1996a). Tranquilizers do not provide analgesia, but reduce the animal's reaction to handling or pain via sedation and CNS depression, and thus have an additional positive effect (Thurmon et al., 1996a). However,

especially in higher doses, phenothiazine tranquilizers depress cardiac and respiratory function. They cause a decrease in arterial blood pressure as a result of depression of vasomotor reflexes. They also have peripheral vasodilatory actions and central hypothermic effects, which can contribute to decreased body temperature in rodents and other small animals (Thurmon et al., 1996a). Acepromazine, a potent neuroleptic agent with high margin of safety, is the most widely used phenothiazine tranquilizer in rodents and should be the first choice among these agents because of its long history of safe use in rodents. The combination of ketamine/acepromazine is unlikely to provide a surgical plane of anesthesia, but may be adequate for smooth induction with inhalants or nonpainful procedures (Gardner et al., 1995). Chlorpromazine has been identified as having varied neurotoxicity on ICR, BALB/c and C57/BL6 and CDF1 mice (Messiha, 1991) and the same could be true for acepromazine, which is closely related.

D. Benzodiazepines: Diazepam

Benzodiazepines such as diazepam (Valium) are sometimes used in combination with ketamine or as a preanesthetic adjuvant for inhalant anesthetics. In therapeutic doses, there are minimal respiratory and cardiac effects. Diazepam has muscle-relaxant and anticonvulsant activities and acts on parts of the limbic system, the thalamus, and the hypothalamus to produce calming effects (Thurmon et al., 1996a). In combination, it counteracts muscle rigidity induced by ketamine. Because of its anticonvulsant activities, it would be an anesthetic adjuvant of choice for models of head trauma, but should be avoided if seizures are the subject of study. The muscle-relaxing activity is due to an effect at the neuromuscular synapse (Thurmon et al., 1996a). Diazepam enhances blockade induced by myoneural blocking agents and other centrally acting muscle relaxants (Dretchen et al., 1971). Diazepam can be antagonized utilizing flumazenil (Lemke et al., 1996).

E. The Action and Use of Opioids in Anesthesia

Opioids such as fentanyl, meperidine, and oxymorphone are added to anesthetic regimens because they provide substantial analgesia in addition to reducing the dose of the primary anesthetic, and the analgesia is effective against visceral pain. Opioids produce a higher level of analgesia than does xylazine at commonly used dosages. This analgesic effect is produced by interacting with opioid receptors that normally act as receptors for the naturally occurring endogenous opioids, endorphins and enkaphalins (Branson and Gross, 2001; Thurmon et al., 1996a). The pharmacology of opioids and other analgesics is covered in Chapter 4. Unlike xylazine and phenothiazine tranquilizers, therapeutic doses of opioids given by SC or IP injection cause minimal depression of cardiovascular function, with minimal

depression of the cardiac rate, rhythm, and cardiac output; thus, they can be used where cardiovascular parameters are under study or where the animal enters the anesthetic period with prior cardiovascular compromise. Additional discussion regarding the actions of opioid drugs is provided in Section IX.D.

1. *Morphine*

The primary beneficial pharmacologic effect of morphine is analgesia. The primary disadvantage of morphine is depression of respiration. Central nervous stimulation with morphine has been reported in the mouse, as in the cat (Thurmon et al., 1996a); it is used less frequently in rodents than is the synthetic opioid meperidine hydrochloride (Demerol). However, the effects of morphine are species specific, and morphine produces analgesia without CNS or respiratory depression in the hamster (Gross, 2001). In guinea pigs, rats, and mice, a low dose of morphine causes elevations in body temperature, while larger doses cause body cooling (Branson and Gross, 2001). Morphine is not recommended for animals with head trauma due to its role in increasing intracranial pressure. Morphine may be used by SC or IM injection in the mouse, rat, and guinea pig as a preanesthetic or analgesic and will be effective within 15 minutes.

2. *Meperidine*

Meperidine hydrochloride (Demerol), like morphine, acts to reduce the amount of primary anesthetic needed and reduces postoperative pain. Per unit body weight, meperidine is 10-fold less active than morphine (Thurmon et al., 1996a). Meperidine should be administered IM or IP because the SC route is painful and locally irritating. Naloxone antagonizes the respiratory depression induced by meperidine but will not antagonize convulsive effects or other CNS stimulatory effects (Gross, 2001). The sedative and analgesic actions of meperidine can be reversed by several narcotic antagonists (Thurmon et al., 1996a).

3. *Fentanyl Citrate*

Fentanyl citrate (Sublimaze[®]), a phenylperadine derivative, is more lipid soluble than morphine, acts rapidly, and is approximately 50–100 times more potent as an analgesic than morphine on a per unit weight basis (Gross, 2001). Fentanyl provides analgesia and sedation with a relatively short duration of action, of less than 30 minutes, but is also a respiratory depressant; it is recommended in combination with fluanisone and diazepam (Flecknell and Mitchell, 1984; Green, 1975). Fentanyl is also used to relieve postoperative pain via a transdermal patch (Dura-gesic) in larger species. Administration via transdermal patch may circumvent the short duration of action via continuous administration. These methods have been used with success in larger animals but are not reported for rodents. With fentanyl,

analgesia may last for a shorter period of time than does respiratory depression, which may last for several hours after dosing (Thurmon et al., 1996b). Shifts in acid–base status during anesthesia or analgesia from acid to base increase the penetration through the blood–brain barrier (Thurmon et al., 1996b). Fentanyl has been reported to increase auditory-evoked potential (AEP) and electroencephalogram (EEG) magnitude during anesthesia (Antunes et al., 2003b). Fentanyl can be reversed by the narcotic antagonists nalorphine and levallorphan.

4. Oxymorphone

Oxymorphone hydrochloride (Numorphan) is a semisynthetic opioid analgesic with a potency approximately 10 times that of morphine that can be used in rodents (Thurmon et al., 1996a). It provides analgesia with some respiratory depression and reduces the dosage of primary anesthetic such as barbiturates. Oxymorphone can be antagonized by levallorphan, nalorphine, or naloxone (Branson and Gross, 2001; Thurmon et al., 1996a).

5. Buprenorphine

Buprenorphine hydrochloride (Buprenex) is a partial agonist with high affinity for the mu-opioid receptor but only partial activity (Branson and Gross, 2001). It is slow in onset and long in duration. It is primarily used for postoperative analgesia because of its long duration of action and minimal adverse side effects, and is used more often than morphine (Gross, 2001). Its analgesic effects may last 8–12 hours depending on dose and species; it may be used for preemptive analgesia (Hayes and Flecknell, 1999; Penderis and Franklin, 2005). Although oral formulations in flavored gelatin for postoperative analgesia have been proposed (Flecknell et al., 1999b), their efficacy has not been consistently documented (Kirsch et al., 2002).

6. Naloxone, Nalorphine, and Levallorphan—Opioid Antagonists

Naloxone hydrochloride (Narcan[®]) is a derivative of oxymorphone and is a pure competitive antagonist to oxymorphone and other opioids such as morphine, meperidine, and fentanyl. Because it lacks agonist properties, it does not produce analgesia or respiratory depression when used alone. Due to its relatively short half-life, reversal effects of naloxone may conclude prior to the respiratory depression effects of the opioid that is being reversed, so animals should be observed until fully recovered. Naloxone also reduces the duration of anesthesia and LD₅₀ of pentobarbital in rats (Branson and Gross, 2001; Lumb and Jones, 1984). The opioid antagonists nalorphine hydrochloride (Nalline[®]) and levallorphan tartrate (Lorfan[®]) are synthetic agents related to morphine and act as both agonists

and antagonists to opioids. Their effect is specific to opioids where they compete for receptor sites. Administration reverses the respiratory depression of opioids. When administered without prior administration of an opioid, they act as CNS and respiratory depressants (Thurmon et al., 1996b).

F. Cholinergic Agents

Physostigmine and 4-aminopyridine are central cholinergic agents that have been shown to shorten ketamine-induced sleeping time, but these agents are not commonly used as reversal agents following ketamine anesthesia in rodents.

G. Local Anesthetics for Anesthesia and Analgesia

1. Injectable Local Anesthetics

Local anesthetics such as lidocaine, bupivacaine, and others may be used to reduce the perception of pain at the surgical site as local or regional anesthetics. However, they are seldom used alone in rodents because, unlike general anesthetics, they do not eliminate stressful perceptions or give immobility during the procedure. The use of local anesthetics without general anesthesia is not recommended for experimental rodents due to humane concerns and chances of bite injury to humans. In conjunction with other agents, their use may allow reduced levels of general anesthetics, which may speed recovery and minimize mortality. These agents act locally on nerve endings or fibers causing a temporary blockade of nerve impulse conduction, and recovery is spontaneous. The duration of analgesia may be prolonged by the concurrent use of a vasoconstricting agent such as epinephrine (Branson and Gross, 2001). When carefully used, direct injection of anesthetic can be a useful adjunct to anesthesia (Arevalo et al., 2004; Flecknell et al., 1990; Sintov and Shapiro, 2004). Local anesthetics can preempt priming of pain perception mechanisms. Local anesthetics, especially long-acting local anesthetics such as bupivacaine, also provide some analgesic effect into the postoperative period. The primary disadvantage of effective use of local analgesics is that they take time to full effect after injection or topical application. Starting the surgery or procedure prior to full effectiveness negates the positive effects of using these drugs.

The two most useful injectable anesthetics for local or regional anesthesia in rodents are lidocaine and bupivacaine. Lidocaine has a fast onset of action with moderate duration of analgesia, is very stable in solution, and spreads through local tissues (Branson and Gross, 2001). It also is effective when applied to the surface of mucous membranes or the cornea. Although epinephrine combined with lidocaine is utilized in larger animals to induce local vasoconstriction and to prolong the duration of action, its use is not recommended in rodents. Lidocaine has been shown to cross the placenta and, in the liver

of fetal guinea pigs, reaches levels higher than maternal hepatic levels (Finster et al., 1972). Bupivacaine (Marcain) has a slower onset than lidocaine, but a longer duration of action. Bupivacaine is also stable in solution and is approximately four times as potent as lidocaine on a percent volume basis. Analgesic duration is at least twice as long as lidocaine and has been reported to last as long as 12 hours in larger species (Hassan et al., 1993; Hayes and Flecknell, 1999), but can be expected to last only 4–7 hours in most rodents (Roughan and Flecknell, 2004). Either morphine alone or bupivacaine plus buprenorphine have been shown to be effective agents for epidural anesthesia in the rat (Akerman, 1985; Morimoto et al., 2001). The opioid meperidine may also be used in rats for local anesthesia, as it exerts a local action on the nerves (Hassan et al., 1989).

2. *Topical Local Anesthetics*

EMLA cream (AstraZeneca), which combines lidocaine and prilocaine in equal amounts in a eutectic mixture, has been recommended prior to procedures such as venipuncture (Flecknell et al., 1990). However, satisfactory efficacy of topically applied EMLA cream takes about 1 hour after application in humans, dogs, cats, and rabbits. It was less effective in rats (Flecknell et al., 1990), which may benefit from a longer preprocedural period. Absorption varies with the time of day at application (Bruguerolle et al., 1991).

H. Neuromuscular Blockade in Rodent Anesthesia

Neuromuscular blocking agents such as D-tubocurarine, gallamine, succinylcholine, and 4-aminopyridine are used as adjuvants to anesthesia when animal movement must be avoided. Since these agents ablate all voluntary movement, their use requires respiratory support, usually via the use of mechanical ventilation. Their use may include cardiac surgery, where respiration must be timed to allow for surgical intervention, or stereotaxic surgery where the slightest movement could result in unintended damage to the brain. In addition to the need for mechanical ventilation, the major disadvantage of the use of paralytic drugs is that animal movement in response to painful stimuli is prevented. Animal movement is the most convenient and readily perceived indicator that the plane of anesthesia is too light. Once movement is prevented, it must be confirmed that pain is not perceived using more intensive methods such as monitoring of heart rate by electrocardiography or brain waves via electroencephalography. For this reason, in most institutions, the use of paralyzing agents requires specific written justification in the animal care and use protocol. This topic is discussed in more detail in Section VIII and also in the chapters on ethical and regulatory issues. Monitoring of the efficacy of paralytic drugs is readily accomplished by the use of stimuli such as toe pinch.

VI. ANESTHETIC REGIMENS USED FOR SPECIAL PURPOSES

A. Inactin: Anesthesia of Long Duration

Inactin (thiobutabarbital sodium salt hydrate), a barbiturate with sedative and hypnotic properties, is primarily used in rodents where a longer duration of anesthesia is needed. Compared to pentobarbital, it has minimal effects on cardiovascular tone and renal output (Buelke-Sam et al., 1978). Inactin may be combined with ketamine in separate IP injections to utilize the initial deeper period of anesthesia to place invasive monitoring equipment for nonsurvival studies such as cardiac catheterization (Lorenz, 2002). The combination of ketamine plus inactin results in a longer duration of action in the rat than in the mouse, and supplementation with additional inactin may be needed for both species during a prolonged procedure (Lorenz, 2002).

B. Alpha Chloralose: Maintenance of Respiratory and Cardiac Reflexes During Anesthesia

Alpha chloralose is used IV to induce anesthesia at a 1–10% concentration but is difficult to dissolve without heating and should not be boiled (Branson and Gross, 2001). Once administered, it is transformed into trichloroethanol, the same active compound that is transformed from chloral hydrate. It acts as a hypnotic and anesthetic with little analgesic effect and thus is less useful for invasive surgery, but may be acceptable for less painful procedures. Chloralose has a unique action in that it depresses the CNS to result in a loss of consciousness while increasing reflex activity (Thurmon et al., 1996b). The use of chloralose is recommended only for long nonrecovery surgical procedures, primarily physiologic experiments, where it is favored for producing stable anesthesia (Rieg et al., 2004) of limited depth (Field, 1988) and minimal depression of respiratory and cardiac reflexes such as baroreceptors and chemoreceptor activities (Branson and Gross, 2001; Thurmon et al., 1996b). Respiratory effects have been shown to vary with the duration of anesthesia (Hughes et al., 1982). Kidney function has also been shown to be more stable under chloralose anesthesia (Rieg et al., 2004). However, approximately 9% of rats developed seizures (Field, 1988). Other authors suggest that fenanyl-fluazone-midazolam provides more stable conditions for physiologic studies (Jong et al., 2002) or suggest that alpha chloralose could be combined with morphine (Wixson and Smiler, 1997).

C. Urethane: Long Duration Anesthesia with Preservation of Autonomic Reflexes

Ethyl carbamate (urethane) may be combined with alpha chloralose and used occasionally as an anesthetic by IP injection

for nonrecovery procedures in laboratory rodents (Dalkara et al., 1995). Urethane is recommended for procedures of exceptionally long duration where preservation of autonomic reflexes is needed, but may be inferior to fentanyl-fluanisone-midazolam combinations (Jong et al., 2002). Prolonged, stable anesthesia with analgesia is produced through the slow metabolism of urethane into carbamic acid and ethyl alcohol. Use in survival procedures is limited by liver damage and pulmonary edema that result from its use (Branson, 2001). Anesthesia in rats produced by urethane administered IP caused peritoneal fluid accumulation, inability to undergo a renal response to NaCl or water loading, and pronounced hyperosmolality of body fluids without affecting plasma $[Na^+]$, which was attributed to osmototoxicity of the mesenteric vasculature (Severs et al., 1981). Urethane use is often prohibited by institutional policy because it has been shown to have a carcinogenic effect in several species including man (Branson, 2001; Cadranel et al., 1993; Field and Lang, 1988; Sorahan and Pope, 1993).

D. Ether: Historical Precedent and Use by Open-Drop Methods

Ether (ethyl ether, diethyl ether, ethyl oxide) is largely of historical interest and is seldom used today because it requires special precautions for safe use due to its explosive and inflammable characteristics (Morch et al., 1956). Ether may be used by an open-drop or chamber method because of its low volatility relative to more modern anesthetics such as isoflurane. Safe use requires storage in an explosion-proof refrigerator to slow degradation within the supply container and off-gassing of animal carcasses in a fume hood to allow volatile peroxides to dissipate after ether anesthesia and prior to carcass disposal. Ether is also not favored because it is a respiratory irritant and causes increased respiratory secretion (Nielsen et al., 1985). When institutional safety policies allow the use of ether, it is utilized because of precedent for its use in some fields and because of its relative safety for the animal when administered by open-drop methods. Some institutions may allow ether to be used for anesthesia of obese and diabetic mice if a vaporizer for isoflurane is not available. It has been recommended that atropine should be administered to mice or rats prior to induction with ether, although atropine is short-lived in rodents (Clifford, 1984; Poole, 1987). Ether is relatively inexpensive and has minimal physiological effects on some parameters, although hypothalamic function may be inhibited and there may be effects on the liver (Flecknell, 1987a; Kobayashi, 1985). Because ether abolishes the corneal blink reflex, eyes of anesthetized animals should be treated with ophthalmic ointment. Differences in ether susceptibility have been reported among strains of inbred mice (Kobayashi, 1985). The use of ether for guinea pigs and gerbils is not recommended due to breath-holding in guinea pigs (Hoar, 1969) and rapid induction in gerbils (Poole, 1987).

VII. OTHER ANESTHETICS

A. Chloral Hydrate

Chloral hydrate is among the first depressants of the CNS used in veterinary medicine. It is a good hypnotic with minimal analgesic properties. It has been recommended for use in rodents (Field, 1988), and continues to be useful in larger species. However, its use in rodents has largely been discontinued by the availability of safer anesthetics that provide better analgesia. When compared to ketamine/xylazine, chloral hydrate produced a greater decrease in systolic and diastolic blood pressures, but less intensive reduction in heart rate (Rodrigues et al., 2006). Both anesthetics promoted an increase in arterial pCO_2 and a decrease in pH levels compared to unanesthetized animals. The blood glucose levels in rats were of a higher magnitude after ketamine/xylazine anesthesia than after chloral hydrate anesthesia (Rodrigues et al., 2006). Chloral hydrate has marked depressant effects on the respiratory system and anesthetic doses approach LD_{50} , reflecting a very narrow margin of safety (Thurmon et al., 1996b). Chloral hydrate is a gastric irritant when ingested and a vascular irritant when injected extravascularly. This irritant property is reflected in repeated reports of adynamic ileus, intestinal obstruction, and death in rats 5–16 days after anesthesia by IP injection (Fleischman et al., 1977; Silverman and Muir, 1993). The incidence of this complication has been so high that the use of chloral hydrate has been prohibited in many institutions due to humane concerns, although adequate justification may result in its continued use in other institutions.

B. Steroid Anesthetics

Saffan (alphaxalone–alphadolone) is a neuroactive steroid anesthetic that can be administered by the IP or IM routes but is primarily recommended for intravenous administration. It is not approved for use or commercially available in the United States. Alphaxalone produces sedative and anesthetic effects with no antinociception, while alphadolone causes antinociceptive effects without sedation (Nadeson and Goodchild, 2000). It can be recommended for intravenous administration to rats, mice, and hamsters, but has limited value in mice and hamsters by the IP route. It may be useful where inhalation anesthesia is not an option because it can be given repeatedly or continuously to maintain anesthesia for long periods without the development of tolerance or cumulation (Green et al., 1978). Saffan can cause seizures in mice (File and Simmonds, 1988).

VIII. USE OF NEUROMUSCULAR BLOCKING AGENTS AND ANTAGONISTS

This section will concentrate specifically on special features of the use of neuromuscular agents in laboratory rodents.

Primary concerns in the use of neuromuscular blocking agents are the provision of analgesia in an animal that cannot respond to pain by movement and the maintenance of adequate oxygenation in an animal that has paralysis of the respiratory muscles (Gibbs et al., 1989; ILAR, 1996, 2003; Office of Laboratory Animal Welfare, 2002). Because the commonly used signs of anesthetic depth such as toe pinch, palpebral reflex, and respiratory rate and depth are abolished when the patient is under neuromuscular blockade, anesthetists need to verify analgesia during neuromuscular blockade by observing the effects of the autonomic nervous system. Though technically challenging, heart rate monitoring and mean arterial blood pressure measurement may be continually evaluated in small rodents, and alterations in these parameters can be used as a gauge of anesthetic depth (Szczeny et al., 2004). Another approach to ensure that analgesia for rodents under neuromuscular blockade will be adequate is to first define best dosage ranges using the same procedure in the same species of animals without the use of the blocking agent (ILAR, 1992). Although electroencephalography (EEG) is a reasonable measure of changing anesthesia depth, it is not a good indicator of actual depth of anesthesia (Dwyer et al., 1994). An additional challenge is that the use of neuromuscular blockers requires the rodent to be mechanically ventilated (Hildebrand, 1997), which can be done safely for rodents with training and experience (Wekslers et al., 1994).

A. Depolarizing Neuromuscular Blocking Agents

Succinylcholine is a commonly used depolarizing agent for mice and rats, which has a rapid onset and a short duration of action, making it useful in short clinical procedures where immobility is needed. Partial paralysis of rats may be maintained with approximately 10–50 $\mu\text{g}/(\text{kg min})$ constant-rate IV infusions with or without an initial IV bolus of 1 mg/kg of succinylcholine (Mishra and Ramzan, 1992b; Rana and Ramzan, 1995).

B. Nondepolarizing Neuromuscular Blocking Agents

Nondepolarizing neuromuscular blocking agents act as competitive antagonists to acetylcholine (ACh) at postsynaptic ACh receptors. Some of these agents are closely related to or derived from curare, a plant toxin from South America, and have more pronounced systemic effects due to histamine release. Nondepolarizing agents that have been used in rodents include atracurium and gallamine. Other agents, including vecuronium, pancuronium, and rocuronium, are steroid analogs that have less deleterious physiologic effects (Hildebrand, 1997).

Atracurium has a quick onset and a relatively short duration of action, thus making it a suitable nondepolarizing agent for short procedures. Under 1.25 MAC of isoflurane or sevoflurane anesthesia, atracurium produces 50% paralysis in rats using an initial bolus dose of 0.31–0.36 mg/kg with maintenance using

3.7–5.0 mg/(kg h) (Shin et al., 1992). While under continuous urethane anesthesia, 50% neuromuscular blockage can be achieved with a constant-rate infusion (CRI) of 3 mg/(kg h) with (Mishra and Ramzan, 1993a) or without (Rana and Ramzan, 1995) a 1 mg/kg IV bolus of atracurium. Much higher doses are necessary to provide for complete paralysis in rats. Under fentanyl anesthesia (1.25 g/(kg h)), a bolus of atracurium at 4 mg/kg followed by 15 mg/(kg h) CRI results in 95% twitch suppression (Bohrer et al., 1994).

Gallamine is a neuromuscular blocker with parasympatholytic actions. When combined with pentobarbital anesthesia (60 mg/kg IP bolus then 10 mg/kg IV, as needed) in rats, gallamine 4–10 mg/kg then 2–6 mg/(kg h) IV depresses twitch tension by 90% and produces paralysis sufficient for artificial ventilation (Gourine et al., 2003; Mishra and Ramzan, 1993b). Approximately 50% paralysis can be achieved with 4 mg/kg bolus and 3 mg/(kg h) IV (Mishra and Ramzan, 1992a, 1993b). In guinea pigs, gallamine produces a dose-dependent bronchoconstriction and thus should be used with caution (Del Monte et al., 1990).

Vecuronium may be administered to rats in numerous ways. With a dose of 0.3 mg/kg injected IV, the induction of paralysis is very rapid (18 seconds) but the duration of action is very short (90 seconds). If administered intratracheally or IM (doses of 1.5 and 2.25 mg/kg, respectively), the duration of action is approximately 8 minutes after induction. The onset of action with intratracheal instillation in rats is about 4.5 minutes, while the onset with IM injection is more than doubled (Sunaga et al., 2006). Infusion of a lower dose of vecuronium (0.14 mg/(kg h)) produces a stable 50% neuromuscular depression (Weinger et al., 1995). When anesthetized with 1.25 MAC isoflurane or sevoflurane anesthesia, vecuronium produces 50% paralysis in rats in a dose range of 0.15–0.19 mg/kg bolus and can be maintained at 2 mg/(kg h) (Shin et al., 1992). Higher bolus (1.5 mg/kg) and infusion doses (7.5 mg/(kg h)) are needed to produce near complete paralysis in rats (Bohrer et al., 1994). Under deep fentanyl anesthesia, a 0.75 mg/kg bolus and a 2.5 mg/(kg h) CRI of pancuronium produce similar results (Bohrer et al., 1994). Rocuronium, another nondepolarizing agent in the curare family, when infused IV at 12–19 nmol/(kg min), gradually increases blockade and produces a steady-state 90% neuromuscular block after 30 minutes (Epemolu et al., 2003).

C. Neuromuscular Blocker Antagonists

Neostigmine and physostigmine are acetylcholinesterase (AChE) inhibitors, which act to increase the amount of ACh at the neuromuscular junction by interfering with the enzyme that degrades ACh. They effectively act to reverse the effects of nondepolarizing agents that rely on low levels of ACh to work effectively. Neostigmine (0.03 mg/kg IV) can reverse the neuromuscular blocking effects of pancuronium in rats (Henning et al., 1993).

These agents also have effects not directly associated with antagonism of neuromuscular blockers. Neostigmine has been demonstrated to counteract the opioid-induced ileus common with morphine and other opioids and slightly increases gastrointestinal motility in rats (Erbil et al., 1998). Physostigmine (0.1 mg/kg IP) may act to antagonize the effects of ketamine in rats, as evidenced by approximately 10–20% reduction in the anesthesia time produced by ketamine alone (75 or 100 mg/kg IP) (Kubota et al., 1999; Mimura et al., 1992), but it does not decrease the limited analgesia provided by ketamine (Mimura et al., 1990). Interestingly, higher doses of physostigmine (up to 0.6 mg/kg) are not as effective as 0.1 mg/kg at antagonizing ketamine (Mimura et al., 1990). In comparison, the ketamine-reversal characteristic of neostigmine increases with increase in dosage between 100 μ g/kg and 200 μ g/kg. Neostigmine has also been shown to shorten the duration of anesthesia from pentobarbital when used in the dose range 150–200 μ g/kg (Leeuwijn et al., 1984).

IX. ANALGESICS FOR MICE AND RATS

Improved pain management for rodents is an important goal in the use of experimental animals. In the past decade, as supported by numerous scientific publications on this topic, there has been an increased emphasis on minimizing pain in experimental rats and mice (Richardson and Flecknell, 2005). Factors contributing to improved rodent pain management include the increased use of mice and rats in biomedical research, continued improvements in humane care and use for all species, and recent scientific documentation that rodents experience pain despite their stoic behavior (ILAR, 1992).

The analgesics most commonly used for rodents and other laboratory animal species are opioids and nonsteroidal anti-inflammatory drugs (NSAIDs). The ultimate decision for selecting a drug must be based on the experimental model under study and the specific types of data to be collected. Here we discuss pain in rodents and provide a discussion of analgesics that are useful in relieving pain in experimental rats and mice, emphasizing the effects of specific analgesics on major types of models. Recommended analgesics, doses, and routes are listed in Table 10-1. For a comprehensive list of drugs with doses, the reader is directed to the formularies by Flecknell (1996) and Hawk et al. (2005); for pharmacology of these drugs, refer to Heavner (1997) and Chapter 4.

A. Assessment of Pain in Experimental Rodents

Assessing pain in rodents can be difficult. Since rodents are prey species that live in large colonies, individuals exhibiting weakness may be targeted as prey by aggressive conspecifics. Rodents minimize pain-associated behaviors unless the pain is incapacitating; therefore, it can be very difficult to detect mild-to-moderate pain in these animals. Momentary observation

of a mouse in a cage may fail to detect painful behaviors despite the presence of severe pain. Signs of pain in mice and rats are listed in Table 10-2, and are also addressed in the chapter that discusses strategies for assessing and minimizing pain. The presence of preexisting pain increases the frequency and strength of some pain-associated behaviors such as withdrawal response to hot plate and tail-flick tests, while reducing the frequency of other normal behaviors such as ambulation and feeding. The effect of painful stimuli and the demonstration of pain-associated behaviors in mice are also influenced by rodent genotype (Liang et al., 2006). The perception of pain in cage mates and neighboring mice may also influence the demonstration of pain behaviors in mice (Langford et al., 2006).

Table 10-3 lists known effects of mouse and rat strain and genotype on the efficacy of analgesic drugs. Age (McLaughlin and Dewey, 1994; Smith and French, 2002; Smith and Gray, 2001), gender (Barrett et al., 2002; Bartok and Craft, 1997; Cicero et al., 2002; Craft, 2003; Craft and Bernal, 2001; Craft and McNeil, 2003; Javan et al., 2006; Ji et al., 2006; Kest et al., 1999; Sternberg et al., 2004), and gonadectomy (Terner et al., 2002) all determine the efficacy of certain analgesics in rodents. Additionally, positive (D'Amato, 1998) and negative social interactions (Canto de Souza et al., 1997; McLaughlin et al., 2006), stress (Filaretov et al., 1996; Kavaliers et al., 1997; Molina et al., 1994; Williams et al., 2005), restraint (Calcagnetti et al., 1990), and exercise (Smith and Yancey, 2003) may produce profound differences in analgesic effects. Dietary components (Kanarek et al., 1997; Zhao et al., 2004) and hardness of food (Ogawa et al., 2003) may also affect the impact of analgesia in rodents subjected to painful stimuli. As discussed below, some drugs are more useful than others in alleviating certain signs and types of pain.

B. Timing of Analgesia

Preemptive analgesia, or the provision of analgesic drugs in advance of the painful stimulus, is a controversial topic, and conflicting evidence exists regarding its efficacy in rodents. In mice, fentanyl fails to provide preemptive analgesia in formalin-induced inflammatory pain (Fu and Scharf, 1995), and neither buprenorphine nor flunixin provides preemptive analgesia for mice undergoing a laparotomy (Goecke et al., 2005). Conversely, liposome-encapsulated hydromorphone provides preemptive analgesia for rats undergoing sciatic nerve resection (Smith et al., 2006), and bupivacaine local nerve blocks prevent subsequent hyperalgesia from thermal pain, but fail to protect rats against hyperalgesia triggered by mechanical stimulation (Themistocleous et al., 2007).

Not only preoperative but also immediate postoperative analgesic administration is important for adequate pain relief in postsurgical rodents. Intermediate doses of morphine (3 mg/kg) given parenterally 30 minutes before, and 30 minutes and 2 hours after a simple abdominal surgery provide adequate pain

relief over a 2-day period. Administration of this same dose later in the postsurgical period provides only transient relief (Gonzalez et al., 2000). Presurgical administration of analgesics will reduce the amount of anesthesia needed during surgery. This is demonstrated by studies showing that rats given buprenorphine at the beginning of a surgery require less propofol over the course of the surgery, resulting in a significantly reduced total anesthesia requirement and significantly improved recovery score (Penderis and Franklin, 2005).

C. Opioid Analgesics

Opioids vary greatly in potency, duration of action, potential side effects, and negative interactions with other compounds. These factors and the expected level of postprocedural pain must be considered when choosing an appropriate opioid to administer to rodents (Gades et al., 2000; Genedani et al., 1999). The most serious adverse effect of opioids is respiratory depression, which may occur depending on the agent, administration, and the target receptor. Respiratory depression is seen more in mu- and delta-agonists and less in kappa-agonists (Heavner, 1997). A common side effect of opioid analgesia is hypomotility of the gastrointestinal tract (Gawrisch and Cheng, 1990), ultimately leading to decreased food intake, which can prolong convalescence and which may be of special concern in models involving gastrointestinal surgery. The development of dependence and tolerance is another important factor in determining the usefulness of opioid analgesia. Tolerance develops with the activation of both mu- and delta-opioid receptors. If only the mu receptor is activated and the delta receptor is blocked, the development of tolerance is greatly attenuated (Roy et al., 2005).

Optimized opioid dosing of rodents is important, not only to prevent high-dose side effects such as respiratory depression, but also to prevent hyperalgesic effects often seen in low-dose opioid administration (Crain and Shen, 2001). Many published rodent formularies offer very wide ranges of doses of opioids; therefore, investigators along with consulting laboratory animal veterinarians must evaluate individual animals to determine what agent and dose is appropriate for a particular species and protocol. These opioid regimens may need to be tested and customized for appropriate dose levels during model development.

Because of their potential for abuse and addiction, most opioids are controlled substances. Regulations delineated by federal or local agencies (e.g., Drug Enforcement Agency in the United States) will necessitate increased security in maintaining a stock of these drugs in animal facilities.

1. Morphine

Morphine (*Duramorph*[®]) is one of the classic opioids often used as a standard to measure comparative potency among opioid drugs. Morphine acts primarily at the mu-opioid receptor,

as demonstrated by studies in mu-receptor knockout mice (Matthes et al., 1996). In vitro morphine has been shown to bind to both delta and kappa receptors. Morphine interacts with other drugs, such as inhalant and injectable anesthetics and analgesics, to reduce the overall necessary dose of anesthetic or analgesic. Subanesthetic doses of ketamine not only potentiate the analgesic response of morphine, but also may further reduce the activity level in rodents concurrently administered both of these agents (Campos et al., 2006).

Regardless of route of administration, morphine has a relatively short duration of action, thus limiting its use in a laboratory animal setting where 24-hour intensive care is not routinely provided. In rats and mice, 10 mg/kg of morphine provides analgesia adequate to relieve severe pain for only 2–3 hours (Gades et al., 2000). Morphine alone has been shown to be effective at alleviating pain due to bone cancer in mice, but more complete analgesia is achieved if morphine is administered concurrently with oral acetaminophen (Saito et al., 2005). In nerve injury models, morphine has been shown to be effective in alleviating pain in rats, contrary to the long-held belief that opioids in general are poor analgesics for neuropathic pain (Erichsen et al., 2005; Joshi et al., 2006). A commonly used dose range, 2–10 mg/kg, is useful to alleviate pain in rats with arthritis induced by complete Freund's adjuvant (CFA) (Davis and Perkins, 1993).

Although morphine administration in mice is not likely to produce inappetence due to ileus, gastrointestinal side effects can be noted in rats at doses as low as 10 mg/kg (Meert and Vermeirsch, 2005; Stevenson et al., 2006). Small intestinal and cecal lumen bacterial counts are increased in morphine-treated rats with 100% incidence of bacterial translocation through the intestinal wall (Erbil et al., 1998).

Encapsulation in a lipid-bilayer liposome greatly increases the intensity of analgesia and extends the duration of action of morphine (Smith et al., 2003; see also Chapter 28) If encapsulated morphine is administered intrathecally, the onset of action is rapid but analgesia is prolonged dramatically, up to 32 times longer duration than parenteral morphine (Kim et al., 1996). Mice develop a tolerance to morphine after several days of repeated single doses (Tokuyama et al., 1998), although tolerance is not noted if the morphine is continuously administered for several days (Backonja et al., 1995). Therefore, morphine may not be an appropriate choice for relief of chronic pain if a CRI is not practical or available. Parenteral dosing of morphine may also produce acute variations in circulating sex hormones in the rat (Ceccarelli et al., 2006).

2. Buprenorphine

Buprenorphine is a preferred analgesic to relieve moderate postsurgical pain in rodents. Buprenorphine (*Buprenex*[®], *Temgesic*[®]) is a partial mu-agonist and is much more potent than morphine, with a longer duration of action. In rats, it has a very wide safety margin, producing a low level of analgesia

at low doses and much stronger analgesia at higher doses, with little increase in side effects (Meert and De Kock, 1994; Meert and Vermeirsch, 2005). Buprenorphine is very useful to relieve moderate pain and is the most practical and clinically useful opioid analgesic for rodents (Roughan and Flecknell, 2002).

Buprenorphine relieves many types of pain. It has been shown to increase the latency of thermal tests over a wide range of doses, but is effective against inflammatory pain over a much narrower range. Buprenorphine is generally less effective against mechanically induced pain; but is effective at higher doses (0.055 mg/kg IV and 0.129 mg/kg IP) in treating neuropathic pain (Christoph et al., 2005). In rat nerve injury models, buprenorphine in this same range reduces mechanical sensitivity without impacting postsurgical body weights (Stewart and Martin, 2003b). The duration of buprenorphine treatment and its dose have a significant effect on the maintenance of body weight in rats. Doses of 0.05 mg/kg versus 0.01 mg/kg appear to produce equivalent analgesia following laparotomy in Sprague-Dawley rats. Rats exhibit a dose-dependent response to the tail-flick test when buprenorphine is administered up to the maximal effective dose of 2.5 mg/kg. Doses exceeding 10 mg/kg SC (up to 80 mg/kg) reduce the pain but to a lesser extent than lower doses (Meert and Vermeirsch, 2005). Repeated doses in the higher range reduce food intake, resulting in weight loss, a consequence not seen at the lower doses (Jablonski et al., 2001). If administered SC, 0.3 mg/kg is effective at eliminating low-intensity thermal pain in rats only 30 minutes post injection, but has limited efficacy for more intense pain over the same period. Higher doses have no additional analgesic effect on this short-time course (Abram et al., 1997). Over a longer time course, SC administration of 0.5 mg/kg in rats produces 6–8 hours of analgesia and 2.0 mg/kg in mice produces 3–5 hours of analgesia (Gades et al., 2000).

Buprenorphine may not provide adequate analgesia for some surgical procedures but can be combined effectively with other opioids or NSAIDs. Buprenorphine was not effective when used alone in a rat bowel transplant model (Camprodon and Bowles, 2006), resulting in poor analgesia and high mortality. Other studies have shown that for specific surgeries, varying doses of parenteral buprenorphine in rats are not effective at reducing pain thresholds below vehicle/control levels (Kirsch et al., 2002) and may actually prolong recovery (Sharp et al., 2003). The analgesic effects of buprenorphine are augmented with the administration of α -2 adrenergic antagonists such as atipamezole to α -2 adrenoceptor knockout mice (Ozdogan et al., 2006). Because buprenorphine is a partial mu-agonist, it can be used concurrently with full mu-agonists, such as morphine and fentanyl, to produce additive effects.

It has been observed that in rats self-medication of buprenorphine (0.5 mg/kg in flavored gelatin) may provide pain relief adequate to maintain food and water intake, avoiding postsurgical weight loss (Flecknell et al., 1999b; Liles et al., 1998), and normal activity after surgery (Jablonski and Howden, 2002). Conflicting studies utilizing pain testing and scoring by Martin

et al. have demonstrated that the pain threshold in rats is not increased with self-medicated oral dosage of buprenorphine. Instead, these reports advocate SC administration of 0.05 mg/kg as an effective dose to increase the pain threshold in rats (Martin et al., 2001; Thompson et al., 2004, 2006). Based on these inconclusive findings, it is recommended that caution be exercised while administering buprenorphine by oral gelatin.

Administration of buprenorphine has been shown to result in pica (e.g., ingestion of bedding) in rats both with and without prior laparotomy (Clark et al., 1997). Buprenorphine-induced pica may reduce long-term growth (Jacobson, 2000). Pica has not been documented as a side effect of buprenorphine in mice. Parenteral dosing of buprenorphine may also produce acute variations in circulating sex hormones in the rat (Ceccarelli et al., 2006). Chronic administration of buprenorphine to rats (1.2 mg/kg twice daily for 14 days) produces analgesic tolerance (Gringauz et al., 2001).

3. Fentanyl

Fentanyl (*Duragesic*) is a full mu-agonist that effectively reduces chronic or dull pain as well as nociception caused by thermal or chemical stimuli. In rat nerve injury models, fentanyl reduces mechanical sensitivity while allowing for the maintenance of weight following surgery (Stewart and Martin, 2003b). Fentanyl is administered to rats and mice in a wide range of doses. Doses of 0.01–1.0 mg/kg IP have been reported to be effective, and dosing may be as infrequent as once per day (El Mouedden and Meert, 2005; Stewart and Martin, 2003a; Stewart and Martin, 2003b). Meert and Vermeirsch (2005) determined that 0.16 mg/kg of fentanyl administered subcutaneously in rats has an onset of action within 15 minutes and produces analgesia for at least 2 hours. Chronically arthritic rats self-medicate with fentanyl in drinking water and alter their intake based on the pain experienced, not by a progressive opioid dependence (Colpaert et al., 2001).

Fentanyl patches designed for transdermal delivery, which are commonly used in a variety of larger animals, are not yet used in rodents due to practical considerations such as the size of the patient relative to the patch and the amount of fentanyl contained in patches originally designed for humans. Because the fentanyl gel matrix is released through the transmembrane at a titrated rate, patches cannot be cut into pieces prior to use without risking a fatal analgesic overdose. Fentanyl may be applied topically to nonhaired skin in an aqueous cream base, and in this preparation fentanyl improved wound healing, wound contracture, cellular proliferation, and angiogenesis in rats (Poonawala et al., 2005). A technique to extend the duration of effectiveness of fentanyl and to mimic the sustained release seen in transdermal delivery is to encapsulate the opioid in liposomes. Encapsulation greatly increases the intensity of analgesia and extends the duration of action of fentanyl (Thornton et al., 1998); however, producing encapsulated fentanyl in-house is an intricate process and commercial availability is limited (Smith et al., 2003).

Fentanyl analogs, such as remifentanyl, alfentanil, lofentanyl, carfentanyl, and sufentanyl, are not currently or commonly used as analgesics in rodents due to the very short duration of analgesia and rapid development of analgesic tolerance (Kissin et al., 1996).

Parenteral dosing of fentanyl may produce acute variations in circulating sex hormones in the rat (Ceccarelli et al., 2006). In rodents, single boluses as well as short-term infusions of fentanyl and fentanyl analogs may result in prolonged hyperalgesia following the surgical procedure (Celerier et al., 2000, 2006). It is advised that complete analgesic coverage postoperatively should combine fentanyl (or its analogs) with other pain medications. In rats, the use of subanesthetic doses of ketamine alleviates this postoperative hyperalgesic state (Richebe et al., 2005). In rats, gastrointestinal side effects from fentanyl are less than those noted with other opioids, and generally occur at doses higher than that are necessary to produce analgesia (Meert and Vermeersch, 2005).

4. Oxymorphone and Hydromorphone

Oxymorphone (*Numorphone*[®]) has limited use because of its abbreviated analgesic duration. If the duration of action can be extended by methods such as encapsulation, it is a good analgesic and may be a practical alternative to other opioids such as buprenorphine. Chronically administered oxymorphone reduces pain-related behavioral changes such as altered grooming behavior, squinting eyes, activity, and agitation in rats subjected to a laparotomy, a result not seen with buprenorphine (Gillingham et al., 2001). This drug has been shown to be effective in treating visceral pain in a gastrointestinal distension model (Briggs et al., 1995). Recently, sustained-release oxymorphone in the form of liposome-encapsulation has allowed for a resurgence in veterinary medical use of the shorter-acting opioids in long-term pain release, specifically in mice (Thornton et al., 1998) and rats (Krugner-Higby et al., 2003; Smith et al., 2003); however, producing encapsulated oxymorphone in-house is an intricate process and commercial availability is limited (Clark et al., 2004). Another unique delivery system is drug-impregnated biodegradable poly(lactic-co-glycolic acid) rods. Although not commercially available as a ready-to-use product, hydromorphone-impregnated rods may be relatively easily produced in the laboratory with some specialized equipment and skills. A total dose of 20 mg hydromorphone rods implanted subcutaneously in the hind limb of rats in sciatic nerve resection injury models provides adequate analgesia for 12 days (Hasirci et al., 2003) based on tail-flick and paw-withdrawal testing (Sendil et al., 2003).

5. Kappa Receptor Agonists: Butorphanol, Nalbuphine, and Pentazocine

Butorphanol (*Torbugesic*, *Torbutrol*, *Stadol*) is a kappa-agonist and mu-antagonist. In mice and rats, butorphanol is

seldom used because it has a short duration (1–2 hours) of analgesia and relieves only minor pain (Gades et al., 2000). The unique opioid-receptor profile of this drug allows butorphanol to be administered to a patient that requires reversal of a mu-agonist, but avoids a complete reversal, that otherwise might result in perceived pain. Butorphanol can reverse the effects of the mu receptor while providing short-term analgesia via the kappa receptor. Lower doses of butorphanol (0.4 mg/kg) and nalbuphine (2 mg/kg) than would otherwise be used for primary analgesia can be used in combination with atipamezole (1 mg/kg) to rapidly reverse the anesthetic and respiratory depression effects of fentanyl (0.3 mg/kg) and medetomidine (0.2–0.3 mg/kg) in rats (Hu et al., 1992) while still maintaining adequate analgesia. Long-term administration of butorphanol may result in analgesic tolerance (Gringauz et al., 2001).

Nalbuphine (*Nubain*[®]) is structurally similar to both naloxone and oxymorphone, and also has a kappa-agonism and mixed mu-agonism/-antagonism receptor profile. Similar to butorphanol, nalbuphine may be used to reverse the respiratory depression caused by mu-agonists, but still provide analgesia from the kappa-receptor activation (Loomis et al., 1989). Nalbuphine is equal in potency to morphine, but causes minimal side effects and has a low potential for abuse. When administered with morphine to rats, nalbuphine eliminated the dependence and tolerance usually seen with chronically administered morphine (Jang et al., 2006; Lee et al., 1997). Unlike other opioids, it has minor effects on gastrointestinal motility and has been shown to promote food and water intake in post-surgical rats, as well as to increase activity (Asai et al., 1998; Flecknell and Liles, 1991). In rats, its duration of action has been shown to be relatively short (2 hours), thus limiting its clinical usefulness (Chen et al., 2002a). In vivo studies involving oil-based preparations of IM-administered nalbuphine have demonstrated that the duration of analgesia is extended to over 2 days (Liu et al., 2004; Wang et al., 2006).

Pentazocine (*Pentagin*[®], *Talwin*[®], *Fortral*[®]) is a kappa-agonist that may be administered for mild-to-moderate pain but is not often used due to development of analgesic tolerance with chronic administration. Activation of the kappa receptor causes little, if any, respiratory depression and its low addiction potential makes pentazocine a safe alternative to mu-agonists for mild-to-moderate pain-producing procedures. In rats, pentazocine increases the level of analgesia to heat-induced pain when coadministered with low doses of morphine (Hamura et al., 2000). Like other opioids, pentazocine markedly decreases gastric emptying time and gut transit time in rodents (Asai et al., 1998).

6. Miscellaneous Opioids

Certain opioid drugs may be less commonly used in laboratory rodents primarily due to a lack of sufficient data about their scientific, pharmacologic, and clinical efficacy. A summary of these agents has been provided based on relevant literature.

Tramadol (*Zydol*, *Ultram*) affects the CNS as an opioid agonist and acts as a serotonin reuptake inhibitor. At relatively low doses, an analgesic effect is not seen, but 20 or 40 mg/kg of Tramadol increases the pain threshold in mice (Erhan et al., 2005). In rats, low doses such as 1.0 mg/kg are effective to increase the pain threshold in rats with experimentally induced arthritis (Kayser et al., 1991). Parenteral dosing of tramadol may produce acute variations in circulating sex hormones in the rat (Ceccarelli et al., 2006). In higher doses of tramadol, opioid-induced ileus is observed, but this reduced activity is overcome by concomitant use of clinically relevant doses of dipyrrone, acetaminophen, or ibuprofen (Planas et al., 2003).

Meperidine (*Demerol*, *Pethidine*[®]) is a mu-agonist with some α -2 adrenergic properties (Takada et al., 2002). Meperidine is useful alone or in combination with other opioids to potentiate opioid analgesia. Meperidine can provide short-term relief from severe pain and has been shown to reduce the threshold for shivering (Paris et al., 2005). This latter effect could be utilized, in specific instances, to reduce involuntary movement under anesthesia and the use of neuromuscular blocking agents. Meperidine has also been demonstrated to offer local anesthetic effects in doses greater than 1.0 mg/kg when injected perineurally (Hassan et al., 1989).

In nerve injury models, methadone, a mu-agonist, has been shown to be effective in alleviating pain in rats (Erichsen et al., 2005), contrary to the long-held belief that opioids in general are poor analgesics for neuropathic pain (Kupers and Gybels, 1995). Methadone has been shown to produce additive analgesic effects when paired with other opioids (Bolan et al., 2002), an effect which may be due to its partial NMDA-antagonist activity (Ebert et al., 1995).

7. Opioid Reversal Agents

Naloxone (*Narcan*[®]) is an opioid antagonist that acts primarily on the mu receptor, but has some blocking activity of the kappa receptors (Kong et al., 1994; Tokuyama et al., 1998). At low doses, it can potentiate the analgesic effects of kappa-receptor agonists, such as pentazocine (Legros et al., 1984; Levine et al., 1988). Naloxone also reverses the analgesic effect of other agents that produce opioid-like analgesics, as well as the analgesic and euphoric effects of endogenous opioids.

Recent work has identified a peripherally acting opioid reversal agent, alvimopam (Greenwood-Van Meerveld et al., 2004). Opioid receptors involved with nociception are typically central (brain and spinal cord), but those involved with producing the side effect of ileus are found in the gut. Because the mu receptors associated with reduction of gastrointestinal motility are peripheral and not central, peripherally acting reversal agents may be used to restore the normal physiology of the gastrointestinal tract with little impact on the analgesic effects of the opioid.

D. Nonsteroidal Anti-Inflammatory Agents

1. Salicylic Acid Acetate (Aspirin)

Aspirin, the oldest commercial NSAID, demonstrates continued efficacy despite having many side effects including reduced hemostasis and increased incidence of gastric ulceration. In rats undergoing laparotomies and organ transplants, oral administration of aspirin maintained a normal activity level (Jablonski and Howden, 2002). Aspirin has been shown to be ineffective in restoring activity to control levels in CFA-induced arthritis models (Millecamps et al., 2005) and formalin-induced inflammatory pain models (Choi et al., 2001).

2. Acetaminophen

Acetaminophen (*Tylenol*, *Paracetamol*, *Datri*[®], *Phenaphen*[®]) reduces pyrexia and provides analgesia, but is quite limited in reducing inflammation (Capetola et al., 1983). Oral acetaminophen alone has been shown to be effective in alleviating bone cancer pain in mice; improved analgesia is provided when acetaminophen and morphine are administered in combination (Saito et al., 2005). Rats with CFA-induced arthritis have been shown to be significantly less active than naïve rats. Arthritic rats treated with acetaminophen have activity levels closer to normal levels (Millecamps et al., 2005), but acetaminophen does not maintain normal activity levels in formalin-induced pain models (Choi et al., 2001). Conflicting evidence in the literature exists with regards to whether voluntarily ingested acetaminophen provides reliable analgesia for rats (Bauer et al., 2003; Mickley et al., 2006) or mice following surgery (Hayes et al., 2000). The analgesic effect of acetaminophen does not seem to be associated with the COX-1 or COX-2 pathways, as it produces very different analgesic profiles when compared with indomethacin, a well-known effector of the COX cascade. Thus, acetaminophen may be used to provide relief in mild-to-moderate pain in animal models involving coagulation, prostaglandin synthesis, and inflammation (Abbott and Hellemans, 2000).

3. Propionic Acid Derivatives: Ibuprofen, Carprofen, Ketoprofen, Ketorolac, and Naproxen

The combination of ibuprofen (*Advil*, *Medipren*[®], *Motrin*, *Nuprin*) and hydrocodone or oxycodone provides better analgesia than opioids or ibuprofen alone, as evidenced by increased time to remove in response to the tail test. This synergistic effect was not seen when ibuprofen was combined with fentanyl or morphine; additional NSAIDs (ketorolac and aspirin) did not add to the effects of hydrocodone or oxycodone (Kolesnikov et al., 2003; Zelcer et al., 2005). In rats, when coadministered with caffeine, high-dose ibuprofen has an analgesic profile similar to that of morphine (Lopez et al., 2006), a level of analgesia

that is not provided by ibuprofen alone. Orally administered ibuprofen in self-medicating mice allowed for a rapid return to normal activity following abdominal surgery (Hayes et al., 2000). Analgesic doses of ibuprofen, otherwise capable of pain relief in other models, did not significantly alleviate pain in capsaicin-induced neuropathic pain models (Joshi et al., 2006). In traumatic brain injury models, rats receiving ibuprofen post injury developed significant learning dysfunction and cognitive deficits compared with injured rats not receiving ibuprofen (Browne et al., 2006).

Combining carprofen (*Rimadyl*[®]) with buprenorphine as a pain medication protocol in rats undergoing laparotomy reduces postoperative depression, anorexia, and water intake (Liles and Flecknell, 1994), as well as other pain-related behaviors (Roughan and Flecknell, 2004). This combination is effective for up to several hours over a wide range of doses in rats with laparotomies (Roughan and Flecknell, 2001, 2003). In rats, oral administration of carprofen via self-administration may not be adequate for controlling pain associated with laparotomy when compared to similar SC doses (Flecknell et al., 1999a). Carprofen was not effective when used alone in a rat bowel transplant model (Campronon and Bowles, 2006) nor was high-dose carprofen (15 ml/kg) effective in alleviating pain or elevating the pain threshold in rats subjected to acute muscle pain (Nielsen et al., 2004). Carprofen is not recommended as the sole analgesic for rodent surgery models.

Oral self-administration of ketoprofen (*Ketofen*[®]) to rats may not be adequate for controlling pain associated with laparotomy when compared to similar SC doses (Flecknell et al., 1999a). With less severe incisional pain, ketoprofen provides analgesia for up to 24 hours at 10–20 mg/kg doses (Prado and Pontes, 2002). Like ibuprofen, ketoprofen combined with caffeine produces the analgesic efficacy in rats, which is two to three times that produced with ketoprofen alone (Diaz-Reval et al., 2001).

Ketorolac tromethamine (*Toradol*[®]) provides very good analgesic properties for visceral, tonic, and inflammatory pain. Although it produces gastric lesions in high or prolonged doses (Padi et al., 2004), ketorolac does not interfere with platelet function. Ketorolac has analgesic effects comparable to strong opioids, yet its effectiveness in preventing pain from direct stimulation of nerves is questionable (Randolph and Peters, 1997). It has very rapid oral uptake (maximal plasma levels at approximately 20 minutes) and has a half-life of 6 hours (Granados-Soto and Flores-Murrieta, 1995). Ketorolac administered with the antibiotic gentamicin is contraindicated, because both drugs have acute kidney effects and together have been shown to promote severe acute tubular necrosis over the course of 3 days (Jaquenod et al., 1998).

Naproxen (*Anaprox*[®], *Aleve*[®]) is a long-acting COX inhibitor that has been seldom used in rodents because of short duration of analgesia and the development of gastric ulceration (Whiteside et al., 2004). The use of this agent in rodents is not recommended.

4. *Dipyrone*

Dipyrone (*Metamizol*[®]) produces very good analgesia over a wide dosage range (150–600 mg/kg) and relieves inflammatory pain (Abbott and Bonder, 1997; Hernandez-Delgado et al., 2002), central pain (Beirith et al., 1998), thermal pain (Hernandez-Delgado and Cruz, 2006; Hernandez-Delgado et al., 2003), and visceral pain (Laird and Cervero, 1996; Laird et al., 1998). Dipyrone acts centrally in the brainstem (Tortorici and Vanegas, 1994; Tortorici et al., 1996) or spinal cord (Neugebauer et al., 1994), either alone or by activating the endogenous opioid pathways (Hernandez-Delgado and Cruz, 2006; Omisore et al., 2004). Despite this apparent mechanism of action, the effects of dipyrone may not be reversible by naloxone (Poveda et al., 2003; Taylor et al., 1998) nor does it produce opioid-induced ileus (Hernandez-Delgado et al., 2002). Repeated doses of dipyrone eventually induce analgesic tolerance, a tolerance that is cross-reactive with morphine tolerance (Hernandez-Delgado and Cruz, 2004; Vanegas and Tortorici, 2002). If these two agents are chronically coadministered, the analgesic tolerances of both agents are delayed by 11–13 days (Hernandez-Delgado et al., 2002, 2003).

Dipyrone use should be avoided for rodent epilepsy models, as intermediate-to-high doses (300–500 mg/kg) reduce limb extension and tonic-clonic plus limbic components of seizures induced by electroshock and sound (Doretto et al., 1998). The analgesic effect of dipyrone does not seem to be associated with the COX pathway (Abbott and Hellemans, 2000). It is suggested that the analgesic effect of dipyrone is not associated with its anti-inflammatory effect (Beirith et al., 1998). Furthermore, dipyrone produces analgesia in adjuvant-induced arthritis models while not reducing inflammation, swelling, and edema (Tatsuo et al., 1994). Thus, dipyrone is a recommended analgesic for adjuvant-induced arthritis models and animal models involving coagulation, prostaglandin synthesis, and inflammation (Abbott and Hellemans, 2000).

5. *Celecoxib and Parecoxib*

Celecoxib (*Celebra*[®]) and, to a lesser extent, parecoxib are two of the more commonly used highly specific COX-2 inhibitors used in rodents. In general, COX-2 specific agents impart less gastrointestinal effects and have better analgesic effects with inflammatory pain, but do induce cardiovascular side effects such as stroke and hypertension.

In rodents, celecoxib has been shown to be ineffective against bone cancer (Medhurst et al., 2002; Saito et al., 2005) or thermal pain (Nishiyama, 2006; Veiga et al., 2004). Pain-associated behavioral alterations following induction of CFA-induced arthritis are alleviated by celecoxib (Millecamps et al., 2005); however, celecoxib also reduces swelling, chronic hyperalgesia, and joint pathology that may or may not be tolerable depending on the aspect of the model under study (Noguchi et al., 2005). A high dose (~30 mg/kg) is necessary to promote

weight bearing in an inducible osteoarthritis model (Pomonis et al., 2005). Analgesic doses of celecoxib, otherwise capable of pain relief in other models, did not significantly alleviate pain in capsaicin-induced neuropathic pain models (Joshi et al., 2006). Chronic administration effectively reduces the severity of endometriosis in mice, while not altering the estrous cycle (Efstathiou et al., 2005). When given for long duration, celecoxib is effective in alleviating incisional pain (Whiteside et al., 2004). Systemically administered celecoxib is capable of alleviating formalin-induced inflammatory pain (Nishiyama, 2006), but has no local effects (Torres-Lopez et al., 2002). Preemptive administration of celecoxib, given prior to the painful stimulus, is highly effective (Veiga et al., 2004). NSAIDs have long been implicated in prolonging fracture healing; thus, opioids have routinely been used in orthopedic procedures. When celecoxib is administered to rats with femoral fractures, there is increased fibrous repair, but not a significantly increased time to healing (Brown et al., 2004).

Parecoxib has more potent synergistic effects when combined with morphine than other COX-2 NSAIDs (Pinardi et al., 2005) and reduces the amount of opioid needed for adequate analgesia. This overall reduction in drug improves the safety margin of the analgesic regime and provides better analgesic coverage. Parecoxib provides relief from inflammatory pain, but it does not relieve visceral or tonic pain (Padi et al., 2004).

6. *Meloxicam and Piroxicam*

Meloxicam (*Metacam*[®]) is primarily a COX-2 inhibitor that acts peripherally to block nociceptors. It reduces swelling in inflamed joints and diminishes pain-related behaviors in arthritic rats (Laird et al., 1997). In rats undergoing laparotomies, meloxicam is effective over a wide range of doses for up to several hours (Roughan and Flecknell, 2003) and raises the chronic hyperalgesia threshold in rats experiencing neuropathic pain (Takahashi et al., 2005). Meloxicam is effective in both inflammatory and neurogenic pain, but has limited analgesic abilities with visceral distension or thermal pain (Santos et al., 1998). Meloxicam exhibits moderate synergistic effects with morphine (Pinardi et al., 2005), allowing a reduction in dose for both drugs and improving the safety margin.

Meloxicam may be ulcerogenic in rats at a clinically relevant dose of 3.2 mg/kg (Jain et al., 2002), although this side effect is reduced by formulating the drug in polyethylene glycol for oral preparations (Vijaya Kumar and Mishra, 2006). Gastric ulceration is also the primary drawback to piroxicam, which is more ulcerogenic than meloxicam (Engelhardt et al., 1995). There have been successful attempts to bypass this deficiency by formulating piroxicam in an orally absorbed preparation, which has been shown to have greater analgesic effects than a commercial tablet preparation (Attia et al., 2004). Both piroxicam and meloxicam may be administered in a topical gel, which produces therapeutic plasma levels while minimizing gastrointestinal side effects (Gupta et al., 2002).

7. *Miscellaneous NSAIDs*

Flunixin meglumine (*Banamine*[®], *Flunazine*), though not frequently used in rodents, reduces inflammatory pain through activation of spinal opioid receptors and is of use in inflammatory conditions (Herrero and Headley, 1996). Flunixin provides excellent anti-inflammatory activity in rat nerve injury models, and promotes greater weight gains than with opioids. This agent has minimal antinociceptive properties and is less effective for providing analgesia following major surgery (Liles and Flecknell, 1994; Stewart and Martin, 2003b).

The primary mechanism of indomethacin is blockade of prostaglandin synthesis due to nonselective COX-1/COX-2 inhibition. It may participate in the centrally located release of endogenous opioids (Suganuma et al., 1998). While indomethacin has been shown to be effective at alleviating bone cancer pain in mice (Saito et al., 2005), it prolongs bone fracture repair in rats (Brown et al., 2004). Interestingly, in rats it has been shown to prevent the unusually rapid metastasis associated with untreated surgical pain (Page and Ben-Eliyahu, 2002). The use of indomethacin in pregnant rats should be avoided because it may cause significant neurologic and behavioral deficits in the pups as they mature (Benesova et al., 2001).

Mechanisms of analgesic and anti-inflammatory actions of diclofenac are unclear; they may be through the inhibition of COX and possibly the lipooxygenase pathways (Scholer et al., 1986) or by activation of K⁺ channels of afferent nerves (Ortiz et al., 2002). Diclofenac is primarily used for the relief of musculoskeletal or neurogenic pain (Santos et al., 1998). In inflammatory pain models, diclofenac has a very good analgesic effect when administered locally near the site of inflammation (Gupta et al., 2002; Jain et al., 2005; Torres-Lopez et al., 2002), but is less effective when administered systemically (Prado and Pontes, 2002).

E. *Other Agents with Analgesic Action*

1. *Ketamine*

Some studies indicate that the NMDA antagonist ketamine improves analgesia when used in conjunction with other agents, especially opioids. In rats, ketamine used as part of the anesthetic combination or in the days following the painful procedure eliminates the hyperalgesia seen with the short-term use of fentanyl (Laulin et al., 2002). In contrast, other studies have supported the usefulness of NMDA antagonists in combination with opioid analgesia (Redwine and Trujillo, 2003).

2. *α -2 Adrenergic Agonists*

α -2 Adrenergic agonists, such as xylazine and medetomidine, do have analgesic effects, but their sedative effects disqualify them from being used as sole analgesic agents. These agents combined with an opioid or NSAID result in a synergistic effect,

extending both the duration and potency of the total analgesic effect (Jain et al., 2002; McLaughlin and Dewey, 1994). Tizani-dine is also used in combination with NSAIDs in order to reduce gastric irritation and ulcerogenesis (Jain et al., 2002).

Clonidine is a centrally acting α -2 adrenergic agonist that provides short-acting analgesia in rodents alone and especially when coupled with an opioid (Hirst et al., 1984). In a formalin model of visceral pain in mice, clonidine provides dose-dependent analgesia over a very wide dose range (0.001–0.1 mg/kg IP) for at least 1 hour (Sabetkasaie et al., 2004). Clonidine given IP at doses greater than 0.02 mg/kg will alleviate hot plate nociception in most rats (Sluka and Chandran, 2002). Significantly higher doses (2 mg/kg) have also been shown to provide mechanical analgesia in mice (Ozdogan et al., 2004; Sluka and Chandran, 2002). Clonidine (0.025 mg/kg) coadministered IP with low-dose morphine (0.5 mg/kg) produces a pronounced synergistic effect to alleviate inflammation pain. In contrast with morphine alone, tolerance does not develop to this combination (Gurtu et al., 1994). Administration of clonidine (0.1 and 1.0 mg/kg) seems to produce different effects in young, mature, and old mice during the active (dark) and inactive periods. During the inactive period, clonidine provides greater analgesic effects in young and mature mice compared with old animals. During the active period, identical doses of clonidine produce a much greater analgesic effect in young and mature mice, but only a slight increase in older mice. Older mice may demonstrate tremors from clonidine administration (Hirst et al., 1984).

3. *Local and Topical Anesthetics*

Administration of local anesthetics such as lidocaine has both analgesic and anti-arrhythmic effects. Lidocaine or bupivacaine may be combined with opioids and NSAIDs to fully relieve pain during the most painful period of 4–7 hours post surgery (Roughan and Flecknell, 2004). Continuously delivered lidocaine, via implantable osmotic pumps, at doses from 0.67 mg/(kg h) to 1.3 mg/(kg h) provides analgesia to alleviate pain produced by a chronic constriction injury model of neuropathic pain and may even reverse the hyperalgesic peak if administered later at three postoperative days (Smith et al., 2002).

Ammonium sulfate and bupivacaine are safe to use in neonatal rodents (Hertl et al., 1998). Analgesic effects are additive and may last for hours when a local anesthetic such as lidocaine or bupivacaine is combined with an opioid analgesic such as morphine, levorphanol, or buprenorphine delivered topically using DMSO (Hayes and Flecknell, 1999; Kolesnikov et al., 2000). Application of morphine in DMSO to the tails of mice produced local, dose-dependent analgesia with no uptake of the morphine by central receptors (Kolesnikov and Pasternak, 1999).

4. *Cholinesterase Inhibitors*

In addition to acting as neuromuscular blocking antagonists, neostigmine and physostigmine have significant analgesic

properties when used in rodents. Physostigmine 50–200 μ g/kg SC produces relief of mechanical and cold-based allodynia in rats, although it does not provide significant analgesia in hot plate stimulation tests (Poyhia et al., 1999).

F. *Adjuncts to Analgesia in Rodents*

While opioids and NSAIDs are by far the most commonly used methods of alleviating pain in rodents, other “alternative” methods of analgesia that may not intuitively be associated with providing analgesia have recently been investigated. Alternatives with limited clinical documentation are not discussed here. (See also the chapter on nonpharmacological pain control.)

1. *Diet and Ingestion of Sweets*

In mice with bone cancer models, soy-based diets may improve the well-being of the animals by reducing the hyperalgesia inherent to these models (Zhao et al., 2004). The ingestion of sweet compounds produces a low-level euphoria and analgesia. Nociception test latencies (e.g., tail flick) are increased in rats after the ingestion of sugar solutions and this effect is reversed by administering opioid receptor antagonists. It is speculated that the sugar compounds not only trigger the release of endogenous opioids (Segato et al., 1997), but also act on serotonergic and noradrenergic receptors (Reboucas et al., 2005). Rats given a wide range of doses of aspartame, an artificial sweetener, exhibited an increased pain threshold (Sharma et al., 2005). There is a synergistic effect when aspartame is given along with various opioids and NSAIDs in rats and mice (Nikfar et al., 1997; Sharma et al., 2005).

2. *Acupuncture*

Acupuncture has only recently become more popular and more accepted in veterinary medicine due to the increase in scientifically based studies investigating its mechanisms of action and documenting results. Many of these studies have been done using rodents. On an anatomic level, acupuncture analgesia seems to be regulated by the hypothalamus, while on a biochemical level an increase in arginine vasopressin seems to elicit an acupuncture-induced analgesic response in the rat hypothalamus (Yang et al., 2006). At the receptor level, naloxone often abolishes the clinical effects of acupuncture, though this may be frequency specific for electroacupuncture (Huang et al., 2002), thus adding evidence to the notion of opioid receptor activation. Recent studies have shown that acupuncture triggers the upregulation of mu receptors in many areas of the rat brain, thus allowing for a greater effect of opioids in treating the animal having pain (Zhu et al., 1995). Evidence suggests that the trigger for electroacupuncture induced analgesia in mice is the release of brain endomorphins and other endogenous opioids (Huang et al., 2000), although some evidence exists that

other mechanisms may also be involved. For example, electroacupuncture in a rat ankle sprain model increases stepping force equivalent to morphine analgesia (Koo et al., 2002), but this effect could not be reversed by naloxone. Electroacupuncture combined with low doses of indomethacin has a synergistic effect on the reduction of hyperalgesia (Zhang et al., 2004).

3. *Dexamethasone*

Dexamethasone provides significant relief from inflammation-based pain in chronic adjuvant-induced arthritis (Colpaert et al., 2001; Wilson et al., 2006). It also allows for a return of normal mobility in arthritic rats (Matson et al., 2007) and improves the clinical condition of aged, adrenalectomized arthritic rats (Yokoro et al., 2003). Dexamethasone does not provide analgesia in rodents with mechanical, neuropathic, and thermal pain (Veiga et al., 2004). While effective in increasing the threshold for pressure pain in endotoxin-induced hyperalgesia, dexamethasone is only marginally effective or ineffective in alleviating thermal pain associated with this model (Kanaan et al., 1997). Thus, the type of model will determine the potential usefulness of dexamethasone.

G. Analgesic Use in Immunologic, Inflammation, and Tumor Studies

Provision of analgesia may compromise experimental results in rodent studies involving immunology, tumor studies, and experimental models of inflammation. There is evidence both supporting and refuting the idea that opioids, NSAIDs, and other analgesic agents may affect the immune system and animal models of inflammation, although a recent review of immunology literature indicated that analgesics were not routinely utilized (Piersma et al., 1999). The use of specific classes of analgesics in model systems likely to cause chronic pain in rodents is discussed below.

1. *Opioids*

Opioids modulate immunological parameters, but this modulation depends on the drug, the dose, and whether the opioid is administered continuously or intermittently. Many opioids modulate the immune system by directly binding the mu receptors on inflammatory cells, by indirectly altering the HPA axis and the glucocorticoid influence on leukocytes, or by the sympathetic effect of noradrenalin on leukocytes (Sacerdote, 2006). Morphine has been shown to suppress NK cells (Saurer et al., 2006), reduce lymphocyte proliferation (Mellon and Bayer, 2001), alter gene expression of MHC II proteins (Beagles et al., 2004), and induce apoptosis in bone marrow macrophages (Malik et al., 2002). Gaveriaux-Ruff et al. (1998) determined that the immune effects commonly seen with morphine usage are due to the activation of the mu receptor, not due to morphine itself;

mu receptor knockout mice demonstrate no immune alteration when morphine is administered. Kappa-agonists are generally strong anti-inflammatory opioids that act through the release of interleukins (Parkhill and Bidlack, 2006), decreased TNF- α release, and reduced adhesion molecule and cytokine expression (Walker, 2003), and are seldom suitable for use in these models.

Morphine suppresses splenic T-cell proliferation without immunosuppression in a mild burn injury model (Alexander et al., 2005). Rats receiving chronic continuous morphine demonstrate no significant immune alteration (measured by NK cell activity, T-cell proliferation, and TNF- α production) compared with saline controls, while bolus-dosing of morphine does induce altered immune function (West et al., 1998). Intermittent, but not continuous, morphine attenuates adjuvant-induced arthritis in rats (Walker et al., 1996). B cells, T cells, and IFN- γ production are maximally suppressed at 1 hour with recovery after 2 hours. Since all measured immunologic parameters return to control levels by 24 hours, preemptive administration of morphine in advance of a painful procedure can provide analgesia without compromising the data generated following recovery (Nelson et al., 1997). A single dose of morphine modulates NK activity from 1 to 12 hours, while fentanyl does not alter NK cytotoxicity in rats following abdominal surgery (Page et al., 2001). Fentanyl has been shown to have significant effects on the immune system, causing a decrease in lymphoproliferation. In sustained-release systems such as osmotic pumps, the effects on the immune system are reduced in a few days and completely absent by 1 week (Martucci et al., 2004).

Buprenorphine has minimal effects on the immune system and is a recommended analgesic for protocols where chronic inflammation is induced such as arthritis, burn, and infectious disease models. Martucci et al. (2004) also showed that neither a single dose of 5 mg/kg or chronic administration of buprenorphine of 0.3 mg/day had any effect on lymphoproliferation, NK cell activity, IL-2, or IFN- γ over 1, 3, or 7 days. Mice administered buprenorphine continuously with an osmotic pump show no alteration in CD4+ or CD8+ lymphocyte populations (D'Elia et al., 2003). Van Loveren et al. (1994) demonstrated a consistent and general lack of immunomodulation by buprenorphine in rats. Buprenorphine given at recommended doses does not induce hematologic, bone marrow, or splenic changes, or alterations in serum immunoglobulins IgM, IgG, IgA, and IgE. The thymus and regional lymph node may become enlarged, but not due to pathologic changes. Natural killer cell functionality is preserved.

When used in rat models of arthritis, buprenorphine is thought to have anti-inflammatory effects, without altering the development of arthritis in CFA-induced arthritis rat models (Walker et al., 1996), but does reduce hock swelling and inflammatory changes in streptococcal cell wall-induced arthritis (Volker et al., 2000). Hall et al. (1996) report that buprenorphine administration to arthritic rats actually worsens the clinical arthritis and increases joint destruction.

Buprenorphine does not seem to alter immune parameters in burn models (Jobin et al., 2000). Unlike other mu-agonists, buprenorphine does not affect the immune system by binding on inflammatory cells or by indirectly altering the HPA axis (Sacerdote, 2006). Studies provide strong evidence supporting the use of buprenorphine in chronic inflammation protocols.

Buprenorphine, when used at clinically relevant doses (0.05 mg/kg BID), does not significantly interfere with the virulence of *Shigella*. It has no effect on the severity of the clinical signs, serum antibody responses, local immune responses in the cervical lymph nodes, and no consistent alteration in antibody-secreting cells (Hanson et al., 2001). In mice experimentally infected with *Toxoplasma gondii*, buprenorphine reduces clinical signs related to pain and distress, but does not alter the life expectancy with acute toxoplasmosis (Lindsay et al., 2005). Because many acute toxoplasma infection studies rely on a rapid decline in clinical condition as a measure of disease progression and therapeutic efficacy, the use of buprenorphine may help in maintaining the comfort of the rodents without significantly affecting the research model.

Thus, several viable options exist for relief of pain in chronic models of inflammation and infection, including pretreatment with morphine, the development of an immune tolerance with fentanyl infusion, and the use of buprenorphine.

2. NSAIDs

As discussed in Chapter 4, NSAIDs such as aspirin and ibuprofen modulate the inflammatory process by acting upon the arachidonic acid cascade. This makes their use unsuitable for many model systems. The COX-2 inhibitors including meloxicam and celecoxib are the best choice to minimize unwanted effects on inflammation, but even COX-2 specific agents still have some COX-1 activity. Aspirin and ibuprofen may not be suitable for infectious disease studies since they have been shown to reduce bacterial and viral numbers (Chen et al., 2002b; Hockertz and Heckenberger, 1996). Indomethacin is also well documented to have significant immunomodulatory effects by increasing microglial cell activity in mice (Prechel et al., 2000) and inhibiting phagocytosis in leukocytes (Mahel'ova and Linkova, 1991).

Abbott and Hellemans (2000) state that acetaminophen and dipyron do not significantly act on the COX cascade in inflammation-induced pain models. Other literature supports the notion that the analgesic effect of dipyron is not associated with reducing inflammation (Beirith et al., 1998), an idea confirming earlier work using dipyron in an adjuvant arthritis model (Tatsuo et al., 1994). This is very important for their potential use in animal models involving coagulation, prostaglandin synthesis, and inflammation. Naproxen, a non-specific COX inhibitor, has no apparent effect on tumor growth or any cytotoxicity (Castonguay et al., 1998). Ketorolac, another nonspecific COX inhibitor, promotes the expression of COX-2 in the presence of cytokines, TNF- α , and IL-1 (Blais et al.,

2002). Pemedoloc is a fast-acting, long-lasting NSAID with a very good oral uptake, analgesic potency, and a wide safety margin. In rodents, levels of 2 mg/kg provide analgesia, whereas 50 times this dose is needed to inhibit inflammation (Chau and Weichman, 1989). This presents the potential for use in inflammation studies, where the alleviation of pain might be achieved without alteration of the inflammatory cascade.

3. *Unrelieved Pain or Distress also Alters Immune Parameters*

Whether or not analgesic drugs are provided, stress, pain, and distress have an effect on the immune system. Surgical pain has been shown to promote abnormal metastasis of tumor cells to the lungs, as shown in studies where provision of the analgesic fentanyl reduced metastatic tumors (Page and Ben-Eliyahu, 2002; Page et al., 2001). Administration of fentanyl or indomethacin reduced the frequency of metastasis to near that of control animals, while Shuey et al. (2006) have shown that oxymorphone is not carcinogenic in either mice or rats. Rodents experiencing surgical pain have reduced natural killer cell activity (Sternberg and Liebeskind, 1995). Mitogen-stimulated leukocytes release endogenous opioids in quantities that activate peripheral receptors and produce analgesic effects in rodents (Verma-Gandhu et al., 2006; Williams et al., 2005). With the significant natural opioid production in response to stress and pain, immune and inflammation models may already be compromised by opioids even without an exogenous source. While no single analgesic provides pain relief without effects on the immune system, there is evidence supporting the selection of individual drugs to spare the specific aspects of inflammation, immunology, or tumorigenesis under study.

X. ANESTHESIA AND ANALGESIA IN NEONATAL MICE AND RATS

Analgesic and anesthetic drugs have sometimes been withheld from neonatal rodents due to concerns that they will cause failure to thrive or increased mortality. There have been historical beliefs have been that very young animals have a high pain threshold and do not feel pain to the extent it is felt by an adult of the same species. The *Guidelines for the Care and Use of Mammals in Neuroscience and Behavioral Research* (ILAR, 2003) stipulate that for experiments involving late-term rodent fetuses after their removal from unanesthetized mothers (such as a dam euthanized by decapitation or cervical dislocation), guidelines for anesthesia and analgesia in neonates should be followed. Potentially painful experimental manipulations in neonatal rodents require the use of anesthesia or analgesia unless the scientist has scientifically justified the nonuse of anesthetics or analgesics to the IACUC. The primary difficulty in using anesthesia or analgesia in the neonate is balancing its effectiveness and safety. Anesthetics that are safely and effectively

used in adult mice and rats are often less well tolerated in neonates (ILAR, 2003). Neonatal anesthesia is covered elsewhere in this text. In general, the margin of safety for injectable anesthetics is narrowed in the neonate and inhalation anesthesia recommended if available. Hypothermia may be an acceptable alternative for some procedures in very young neonatal rodents.

A. Anesthetics

Inhalants are a good first choice for anesthesia of neonatal rodents (ILAR, 2003). Although halothane is not readily available and isoflurane is very popular for use in rodents, isoflurane may not be as safe as halothane when anesthetizing neonatal mice. Loepke et al. (2006) demonstrated that 10-day-old mice required mechanical ventilation in order to survive 60 minutes of isoflurane anesthesia. Isoflurane anesthesia of 3- and 10-day-old mice is safe for noninvasive imaging studies (Wiesmann et al., 2000) and is neuroprotective (Zhao and Zuo, 2004).

When inhalants cannot be used for safety or for practical reasons, hypothermia is a relatively safe and effective alternative to injectable drugs in altricial rodents up to 7 days of age (Cunningham and McKay, 1993; Danneman and Mandrell, 1997; Phifer and Terry, 1986). Hypothermia is the most common method of anesthesia in neonatal altricial rodents, providing both immobilization and mild analgesia when body temperature is reduced to 10–20°C (Phifer and Terry, 1986). Altricial rodents function as poikilotherms in that their body temperature and metabolic rate are closely correlated to the ambient temperature. Analgesic depth during hypothermia is less controlled than that during inhalant anesthesia. Ice or cold water may be used to induce hypothermia in rodent neonates, and more sophisticated systems to chill rodent pups are available. Pups must not come in direct contact with ice to avoid skin lesions due to frostbite.

Some injectable anesthetics may also be safely used in neonatal rodents. Fentanyl plus fluanisone is safe and effective for most surgical procedures (Clowry and Flecknell, 2000). Ketamine may be used safely in neonatal rats and mice (Rofael et al., 2003). Danneman and Mandrell (1997) demonstrated that the combination of ketamine and pentobarbital should be used with caution in neonatal (1–3-day-old) rat pups because a dose sufficient to anesthetize only 80% of pups resulted in up to a 70% fatality rate. In the same study, less effective anesthesia but a similar fatality rate was produced by 35 and 40 mg/kg of pentobarbital.

B. Analgesics

Opioids safely provide effective analgesia against thermal, inflammatory, and mechanical pain in neonatal rodents (Barr, 1999; ILAR, 2003). Morphine produces safe analgesia in both 3- and 21-day-old rat pups (Gupta et al., 2001). Rats are most sensitive to morphine at 6–7 days old (Van Loveren et al., 1994), requiring lower doses to provide a similar effect to higher

doses in older animals. Fentanyl, meperidine, buprenorphine, and morphine can also be used safely in neonates (Danneman and Mandrell, 1997; McLaughlin and Dewey, 1994; Thornton et al., 1998). Fentanyl and droperidol (160 $\mu\text{g}/\text{kg}$ and 800 $\mu\text{g}/\text{kg}$ IP, respectively) have been shown to be a safe combination for light anesthesia, but not for a surgical level of anesthesia (Danneman and Mandrell, 1997). Morphine, at 10 mg/kg administered subcutaneously, alleviates pain associated with a laparotomy in day-old pups to the level where distress vocalizations are significantly reduced (Bartok and Craft, 1997). There is little information in the literature regarding the use of NSAIDs to relieve pain in neonatal rodents. Ketorolac has analgesic and anti-inflammatory activity in neonates, more so in 21-day-old than in 3-day-old pups (Gupta et al., 2001).

The use of analgesia has significant welfare implications in the neonate, and early use of analgesics may also affect pain sensitivity later in life. Stress (such as cold exposure, excessive restraint and handling, and separation from the dam) and drug exposure as a neonate may also alter adult sensitivity. Exposure to stressful or painful stimuli as a neonate can also alter the rodent's nociception later in life, reducing pain behaviors to noxious stimuli (Sternberg et al., 2005). Sternberg and Ridgeway (2003) determined that nociception thresholds are increased by prenatal or postnatal stress in male and female mice. Stress responses in adulthood, as well as adult morphine sensitivity, are reduced in perinatally stressed rats (Kalinichev et al., 2001). In utero exposure to opioid antagonists has been shown to desensitize offspring to the effect of opioid analgesia later in life (Zagon et al., 1998).

XI. SPECIAL CONSIDERATIONS FOR POSTPROCEDURAL MONITORING OF RODENTS

Special considerations for postanesthetic monitoring of rodents are discussed below. Additional information about this topic is provided in the first edition of this book (Wixson and Smiler, 1997). During the period when animals are regaining consciousness, the recovery area should be visible to personnel, yet in a space away from loud noise and personnel trafficking. Any wet hair on the animal should be dried gently with towels or by using warmed air. Controlled and prophylactic fluid loading can assist in recovery primarily because self-hydration will naturally be inhibited during the recovery phase. Dehydration can compound anorexia, generalized weakness, and the ability to regulate body temperature following anesthesia. It is advisable to provide additional fluids (typically administration of physiologic saline or lactated Ringer's solution) in small bolus volumes (1.0 ml) given IP or SC. Mortality has been shown to decrease significantly in mice receiving 0.9% sodium chloride prior to recovery from anesthesia (Flecknell, 1993; Smith et al., 1999). Rodents should be minimally handled and placed alone in recovery caging to avoid fighting or cannibalism by conscious

cage mates. The administration of postoperative analgesics is also recommended, with longer-acting agents recommended to prevent excessive handling (Cantwell, 2001).

The hypothermia that can be induced by a variety of anesthetics can be detrimental to postoperative recovery and scientific outcomes. Hypothermia is probably the single most important cause of anesthetic mortality in mice (Flecknell, 1993). Additional hypothermia due to fluid loss and heat loss during anesthesia can also slow recovery and be a source of distress for the animal. The overriding principle that seems to work most efficiently is to prevent heat loss rather than to treat it once it occurs (Cantwell, 2001). Supplemental heat should be provided in the form of a re-circulating warm water blanket, isothermal heat source, or nontoxic self-heating chemical warming packs (such as Grabber Mycoal 12+ Hour Pocket Warmers, Grabber Performance Group, Grand Rapids, MI) that can be left in the animal's cage overnight (Bagis et al., 2004; Cantwell, 2001; Rembert et al., 2004; Weinandy et al., 2005). Electric heating pads are discouraged because of uneven heating and tendency to cause thermal burns. Regardless of the heat source, the animal must never be placed directly on the heat but should be separated from it by a towel or sterile drape. Covering the animal with a surgical drape, aluminum foil, or insulating cotton wool also helps to conserve body temperature. When covering an anesthetized animal, be careful not to place excessive pressure over the thorax or obstruct nasal passages. It is imperative to monitor body temperature to ensure that the measures taken are effective, and also to avoid over-heating of the animal (Flecknell, 1987b). The use of forced-air warming blankets (FAWB), which are perforated to blow warmed air directly on the animal, along with coverage by a plastic drape, has been shown to provide superior thermal support to circulating warm water blankets and infrared heat emitters (Rembert et al., 2004). A negative aspect of the FAWB may be the initial cost of the equipment, which is over \$1,000 per unit. Blanket temperatures should be in the range of 37–40°C for rodents (Flecknell, 1993).

Laboratory animal personnel should frequently observe and closely monitor rodents during the recovery period, particularly to assess loss of appetite, dehydration, lethargy, or abnormal healing of surgical sites (Hoff et al., 2006). Once an animal has regained consciousness, the residual effects of many anesthetics may persist for up to 48 hours, resulting in depression of food and water intake and prolonged ataxia (Flecknell, 1987b). It is useful to record body weight before and after anesthetic procedures. Weight losses are typically seen during the anesthetic and recovery periods in rodents. Body weight may take several days to return to preanesthetic levels, even if food and water consumption appears within normal limits (Hayton et al., 1999; Lawson et al., 2001). It is often recommended to provide food and water immediately after recovery, including solid pellets on the cage floor to prompt ingestion following anesthesia. Normal circadian rhythms, as assessed in telemeterized rodents, may also take several days to return to preprocedural levels (Weinandy et al., 2005). Body condition scoring is a helpful

tool to monitor the pre-, peri-, and postanesthesia appearance and health of rodents (Easterly et al., 2001; Ullman-Cullere and Foltz, 1999).

The multimodal treatment approach should also include appropriate pre- and postoperative analgesics (see Section IX). Numerous postoperative behavior-based pain scoring mechanisms have been devised for rodents (Clark et al., 1997; Roughan and Flecknell, 2001, 2003, 2004). Continued improvements in anesthetic regimens for laboratory rodents are an important implementation of Russell and Birch's "3 R's" (Russell, 1959), both for refinements in animal experimentation and for improvement of animal health and welfare.

XII. OTHER RODENTS, INCLUDING GUINEA PIGS, HAMSTERS, AND GERBILS

Rats of the genus *Rattus* and mice of the genus *Mus* are the most common rodent species used in research, and information regarding anesthesia and analgesia of other rodent species is limited and frequently antiquated. Of the more than 100 published articles evaluated for inclusion in this subsection, more than 75% were 15 years or older. However, it should be noted that much of the earliest work on specific anesthetics and analgesics began in these "other rodent" species, while few of the newer drugs have been studied in these relatively uncommon laboratory animals.

The rodent species discussed in this section are covered by the Animal Welfare Act and thus are required to receive appropriate relief to potentially painful or distressful procedures as described in the Act and in USDA Policy #11 (Code of Federal Regulations, 1997). As part of the Act and USDA Policy #12 (Code of Federal Regulations, 2000; Code of Federal Regulations, 2002), investigators must also perform a comprehensive literature search and consider any alternative to potentially painful or distressful procedures performed on covered rodent species (Code of Federal Regulations, 2000). These alternatives may include refinements to the anesthetic and analgesic protocols used for these species.

Like mice and rats, these other rodents require special consideration when administering anesthetics and analgesics. Most small mammals are primary or obligate nasal breathers, thus patency of the nares and nasopharynx is crucial whether using inhalant or injectable anesthesia (Heard, 2004). Even the large rodent species used commonly in biomedical research (e.g., *Marmota* or guinea pigs) are small enough to necessitate use of nonbreathing systems when using gas anesthesia (Lerche et al., 2000). There are few published reports describing the clinically relevant use of inhalant anesthetics in these other rodents.

A. Guinea Pigs

Several anatomical aspects of the guinea pig (*Cavia porcellus*) are relevant to anesthesia for this species. Nearly the

entire tongue of a guinea pig is tightly attached to the oropharynx, making this one of the most difficult laboratory animal species to intubate. The very large cecum can make drug calculations challenging, as the effective weight of the animal can be considerably less than the body mass with cecal contents. The pedal reflex is not always a reliable measure of anesthetic depth because guinea pigs make involuntary leg movements even while under a surgical plane of anesthesia (Harkness and Wagner, 1995).

1. Anesthetics

In guinea pigs, an administered dose of ketamine 87 mg/kg and xylazine 13 mg/kg with supplemental boluses of ketamine is recommended for anesthesia (Barzago et al., 1994). This combination dose is higher than other published doses (30–35 mg/kg ketamine with 0.2–5.0 mg/kg xylazine) that may require numerous additional bolus doses of ketamine for anesthetic maintenance (Barzago et al., 1994; Hart et al., 1984). The combination of 30 mg/kg ketamine and 5 mg/kg xylazine provides approximately 30–50 minutes of anesthesia and is appropriate for noninvasive echocardiographic evaluations but not surgical procedures (Cetin et al., 2005). A general range of 40–120 mg/kg ketamine with 10 mg/kg xylazine provides anesthesia in a dose-dependent manner. Ketamine has a large margin of safety in guinea pigs and anesthesia-related fatalities are not expected until doses of greater than 300 mg/kg ketamine are administered (D'Alleinne and Mann, 1982).

The administration of inhalant agents, such as methoxyflurane, to guinea pigs can significantly potentiate the anesthetic and analgesic properties of ketamine/xylazine (Radde et al., 1996) and the use of ketamine plus xylazine prior to inhalation anesthesia will avoid induction of breath-holding by guinea pigs. In guinea pigs, unlike other rodents, breath-holding is so marked that an anesthetic chamber should not be used for induction. Breath-holding can result in a sudden deep breath of anesthetic gas followed by respiratory and/or cardiac arrest. For prolonged cardiorespiratory assessments in the guinea pig, combining low IV bolus doses of ketamine and xylazine hourly (14.6 and 3.7 mg/kg, respectively) with inhalants may be effective (Schwenke and Cragg, 2004).

Telazol alone at 50–100 mg/kg has been found to be completely ineffective as an analgesic in guinea pigs (Radde et al., 1996; Ward et al., 1974). Telazol (60 mg/kg IP), xylazine (5 mg/kg IP) plus butorphanol (0.1 mg/kg IM) is acceptable for prolonged anesthesia with significant analgesia and minimal effects on physiologic parameters (Jacobson, 2001).

Fentanyl (1.0 mg/kg IM) and diazepam (5 mg/kg IP) anesthesia is an appropriate combination for minor surgical procedures on guinea pigs without causing respiratory depression (Mertens and Muller-Deile, 1991). Morphine (50 mg/kg IP) produces a significant level of hypothermia in guinea pigs, which can be counteracted with dexamethasone (0.5–1.0 mg/kg IP) (Milanes et al., 1984).

Guinea pigs experience deep anesthesia when pentobarbital (15 mg/kg IP) is combined with fentanyl-droperidol (Innovarvet®) (0.4 mg/kg IM) (Brown et al., 1989). Consistent deep anesthesia has also been induced in guinea pigs by combining pentobarbital (45 mg/kg IP) with xylazine (7 mg/kg) (Rhodes et al., 2001). Specific attention must be given to the IM site of injection of fentanyl-droperidol as guinea pigs may chew their feet or amputate their toes if administered at high doses, especially if the injection is given too close to the ischiatic nerve (Leash et al., 1973; Newton et al., 1975).

Sublethal doses of CO₂ have proven to be an effective anesthetic in guinea pigs for ultrashort-term procedures such as cardiac bleeding (Kohler et al., 1999). Guinea pigs exposed to carbon dioxide gas must be watched constantly and removed from the induction chamber promptly after they recline in lateral recumbency. Intermediate-term, low-dose halothane anesthesia has been shown to be hepatotoxic in Strain 13 (Lind et al., 1989) and Strain 2 (Lind et al., 1987) guinea pigs, inciting a centrilobular necrosis, which is almost nonexistent in inbred Hartley guinea pigs. Hepatic necrosis is evident on the second day after inhalant anesthesia and is transient, resolving after about 7 days. Isoflurane does not appear to have a hepatotoxic effect (Lunam et al., 1985). In naïve guinea pigs, methoxyflurane anesthesia induces a two- to fivefold rise in plasma cortisol, similar to that of surgery, although timing is delayed (Kipp et al., 1989).

2. Analgesics

Meloxicam (0.5 mg/kg PO) and naproxen (5 mg/kg PO) produce significant analgesia in visceral pain tests in guinea pigs, while the addition of clonidine (0.25 mg/kg PO) improves analgesia even more so (Jain et al., 2002). Guinea pigs are sensitive to naproxen-induced gastric ulceration at high doses (80 mg/kg BID), a dose about five times greater than a known ulcerogenic dose in rats (Jain et al., 2002). The incidence of this gastric ulceration in guinea pigs occurs within a few days and decreases over a 3–21-day period as the cellular population of the stomach adapts to long-term administration of naproxen. Naproxen-induced ulceration is prevented by misoprostol, but not famotidine (Fitzpatrick et al., 1999). Indomethacin does not cause gastric ulceration in guinea pigs (Mariani and Bonanomi, 1978). Aspirin is ototoxic in guinea pigs at doses as low as 50 mg/kg (Crifo, 1975).

B. Hamsters

Ketamine, xylazine, and Telazol are common parenteral anesthetics considered safe and effective in the Syrian hamster (*Mesocricetus auratus*). Chloral hydrate and pentobarbital are not recommended due to significant side effects. As a general rule, because of the size and anatomical position of the testes, careful and deliberate orientation of male hamsters receiving IP injections is vital to prevent accidental injection into the testes. Though not available in the United States, fentanyl/fluonisonone

(Hypnorm) may also be used safely in hamsters (Flecknell, 1996).

1. Anesthetics

In Syrian hamsters, a dose of 150 or 200 mg/kg ketamine with 10 mg/kg xylazine IP fairly consistently produces an adequate level of anesthesia for most procedures (Curl and Peters, 1983; Payton et al., 1993). Lower doses of ketamine are less reliable in this species. In Djungarian hamsters (*Phodopus* spp.), ketamine 50–100 mg/kg and xylazine 5–10 mg/kg administered IP produce a satisfactory level of general anesthesia. Although ketamine is generally considered very safe in most species, twice this dose of ketamine in *Phodopus* hamsters (200 mg/kg) is fatal in about 50% of the recipients (Curl, 1988). In neonatal *Phodopus*, a lower dose of ketamine (40 mg/kg) and xylazine (4 mg/kg) administered IP produces a surgical plane of anesthesia within 3–4 minutes, which lasts for at least 30 minutes (Vella et al., 2004). Although ketamine and xylazine in combination appear to be very safe in hamsters, Gaertner et al. (1987) demonstrated that IM injections of 100–200 mg/kg ketamine with 10 mg/kg xylazine consistently produce moderate-to-severe muscle necrosis at the injection site. When possible, ketamine should be administered IP in hamsters. If IM injections are required, injection-related necrosis may be reduced by diluting the stock concentration, thus decreasing the acidity of the drug.

Telazol 20 mg/kg and xylazine 10 mg/kg IP in hamsters was adequate for restraint, but necrotic muscle lesions may appear following IM injection. Higher doses of Telazol (30 mg/kg) combined with 10 mg/kg xylazine IP produce a safe, reliable level of surgical anesthesia (Forsythe et al., 1992). Lower dosages of Telazol in hamsters are suitable for less painful, noninvasive experimental manipulations (Hrapkiewicz et al., 1989). Hamsters may exhibit poor respiration following Telazol administration (Silverman et al., 1983).

Pentobarbital (70 mg/kg IP) produces profound respiratory perturbations in hamsters, manifested by decreased tidal and minute volumes, reduced breathing rate, and increased airway resistance (Skornik and Brain, 1990). Pentobarbital has been successfully combined with acepromazine for abdominal surgery (Dubois et al., 1981), and with chloralose and urethane for long-term, deep anesthesia for nonrecovery surgical procedures (Reid et al., 1989). Approximately one-third of male Syrian hamsters injected IP with 350 mg/kg chloral hydrate may die within 10 days due to severe peritonitis and ileus. Within 2–3 weeks, hamsters given chloral hydrate routinely develop intraabdominal adhesions, testicular atrophy, and abdominal fat necrosis (Dada et al., 1992).

2. Analgesics

High doses of morphine (80 mg/kg) produce sedation in hamsters, while lower doses (10 mg/kg) do not appear to have

any behavior effects, except a reduction in sexual response in females (Ostrowski et al., 1979). This diminished sexual activity is reversible by naloxone. Fetal deaths associated with prolonged gestation lengths may be seen in hamsters and rats administered naproxen once or twice daily; thus, this particular NSAID should be used with caution in pregnant hamsters (Vickery, 1979).

C. Gerbils

In Mongolian gerbils (*Meriones unguiculatus*), Telazol 60 mg/kg seems to be safe and suitable for major surgical procedures, while lower doses are sufficient for immobilization for noninvasive procedures (Hrapkiewicz et al., 1989). Ketamine (75 mg/kg) and medetomidine (0.5 mg/kg) provide at least 30 minutes of safe, repeatable anesthesia in gerbils (Perez-Garcia et al., 2003). Gerbils receiving 80 mg/kg pentobarbital exhibit profound hypothermia during relatively simple 60-minute surgical procedures (Weinandy et al., 2005) and experience prolonged recovery times compared with ketamine (Lightfoote and Molinari, 1978).

D. Other Rodents

Woodchucks (*Marmota marmota*) may be anesthetized for short-term procedures using xylazine (3 mg/kg) plus ketamine (40 mg/kg), medetomidine (0.25 mg/kg) plus ketamine (35 mg/kg), or xylazine (3 mg/kg) mixed 1:1 with Telazol (15 mg/kg). For procedures of longer duration and surgery, these doses may be safely increased approximately twofold. Although hypothermia may be seen with any anesthetic, poor muscle relaxation with xylazine–ketamine, and prolonged induction duration with xylazine–zolazepam–tiletamine, these drugs and doses provide safe and efficient anesthesia in marmots (Beiglbock and Zenker, 2003). Alternatively, a simple dose of 50 mg/kg ketamine has been shown to produce enough sedation to allow simple procedures like blood collection (Frase and Van Vuren, 1989). Pentobarbital (30 mg/kg), urethane (2 g/kg), chloralose/urethane (50 mg/kg and 500 mg/kg, respectively), and thiobutobarbital (100 mg/kg) have all been demonstrated to produce profound cardiovascular depression in *Marmota flaviventris*, and thus should be used with caution (Zatzman and Thornhill, 1988).

A combination of ketamine and xylazine has been used for anesthesia and analgesia in deer mice (*Peromyscus maniculatus*); ketamine alone at a dose of 100 mg/kg provides anesthesia, but not analgesia in this species (Silverman and Ingram, 1986).

Meperidine not only reduces the response latency to thermal pain, it also seems to promote aggressive behavior in naked mole rats (*Heterocephalus glaber*). Acetaminophen and indomethacin also provide significant analgesia to thermal pain (Towett and Kanui, 1993). Acetaminophen (200–400 mg/kg)

and morphine (10–20 mg/kg) both provide alleviation of inflammatory pain (Payton et al., 1993); however, morphine elicits fatally aggressive behavior in colony-housed *Heterocephalus* (Kanui and Hole, 1990).

The combination of 1.0 mg/kg midazolam, 0.05 mg/kg medetomidine, and 0.02 mg/kg fentanyl IM produces a surgical level of anesthesia that lasts for approximately 1.5 hours in chinchillas (*Chinchilla lanigera*). This combination precipitated a recovery time of about 40 minutes, which was shortened to just 5 minutes with administration of the corresponding reversal agents: flumazenil (0.1 mg/kg), atipamezole (0.5 mg/kg), and naloxone (0.05 mg/kg) (Henke et al., 2004).

In the bushy-tailed woodrat (*Neotoma cinerea*), ketamine is safe and effective at doses ranging from 30 to 110 mg/kg, producing chemical restraint to allow for easy handling and blood collection (Frase and Van Vuren, 1989).

In the Richardson's ground squirrel (*Spermophilus richardsonii*), a combination of ketamine (85 mg/kg) and xylazine (10 mg/kg) IM or SC provides effective surgical anesthesia for 20–30 minutes. Ketamine alone (85 mg/kg, IM), droperidol/fentanyl combination (2.5 mg/kg and 50 µg/kg IM, respectively), or pentobarbital (50 mg/kg IP) does not induce anesthesia adequate for surgery, but does produce respiratory depression in this species (Olson and McCabe, 1986).

REFERENCES

- Abbott, F.V., and Bonder, M. (1997). Options for management of acute pain in the rat. *Vet. Rec.* **140**(21), 553–557.
- Abbott, F.V., and Hellems, K.G. (2000). Phenacetin, acetaminophen and dipyrone: Analgesic and rewarding effects. *Behav. Brain Res.* **112**(1–2), 177–186.
- Abram, S.E., Mampilly, G.A., and Milosavljevic, D. (1997). Assessment of the potency and intrinsic activity of systemic versus intrathecal opioids in rats. *Anesthesiology* **87**(1), 127–134 (discussion 27A–29A).
- Adachi, Y.U., Satomoto, M., Higuchi, H., Watanabe, K., Yamada, S., and Kazama, T. (2005). Halothane enhances dopamine metabolism at presynaptic sites in a calcium-independent manner in rat striatum. *Br. J. Anaesth.* **95**(4), 485–494.
- Akerman, S.B. (1985). A methodological study of spinal (subarachnoid) anaesthesia in the rat and the mouse. *Br. J. Anaesth.* **57**(3), 329–332.
- Alexander, M., Daniel, T., Chaudry, I.H., and Schwacha, M.G. (2005). Opiate analgesics contribute to the development of post-injury immunosuppression. *J. Surg. Res.* **129**(1), 161–168.
- Alkire, M.T., Nathan, S.V., and McReynolds, J.R. (2005). Memory enhancing effect of low-dose sevoflurane does not occur in basolateral amygdala-lesioned rats. *Anesthesiology* **103**(6), 1167–1173.
- Altholtz, L.Y., Fowler, K.A., Badura, L.L., and Kovacs, M.S. (2006). Comparison of the stress response in rats to repeated isoflurane or CO₂:O₂ anesthesia used for restraint during serial blood collection via the jugular vein. *J. Am. Assoc. Lab. Anim. Sci.* **45**(3), 17–22.
- Amouzadeh, H.R., Sangiah, S., and Qualls, C.W., Jr. (1989). Effects of some hepatic microsomal enzyme inducers and inhibitors on xylazine-ketamine anesthesia. *Vet. Hum. Toxicol.* **31**(6), 532–534.
- Antunes, L.M., Golledge, H.D., Roughan, J.V., and Flecknell, P.A. (2003a). Comparison of electroencephalogram activity and auditory evoked responses during isoflurane and halothane anaesthesia in the rat. *Vet. Anaesth. Analg.* **30**(1), 15–23.
- Antunes, L.M., Roughan, J.V., and Flecknell, P.A. (2003b). Excitatory effects of fentanyl upon the rat electroencephalogram and auditory-evoked potential responses during anaesthesia. *Eur. J. Anaesthesiol.* **20**(10), 800–808.
- Arvalo, M.I., Escribano, E., Calpena, A., Domenech, J., and Queralto, J. (2004). Rapid skin anesthesia using a new topical amethocaine formulation: a preclinical study. *Anesth. Analg.* **98**(5), 1407–1412.
- Arras, M., Autenried, P., Rettich, A., Spaeni, D., and Rulicke, T. (2001). Optimization of intraperitoneal injection anesthesia in mice: drugs, dosages, adverse effects, and anesthesia depth. *Comp. Med.* **51**(5), 443–456.
- Asai, T., Mapleson, W.W., and Power, I. (1998). Effects of nalbuphine, pentazocine and U50488H on gastric emptying and gastrointestinal transit in the rat. *Br. J. Anaesth.* **80**(6), 814–819.
- Attia, M.A., El-Gibaly, I., Shaltout, S.E., and Fetih, G.N. (2004). Transbuccal permeation, anti-inflammatory activity and clinical efficacy of piroxicam formulated in different gels. *Int. J. Pharm.* **276**(1–2), 11–28.
- Backonja, M.M., Miletic, G., and Miletic, V. (1995). The effect of continuous morphine analgesia on chronic thermal hyperalgesia due to sciatic constriction injury in rats. *Neurosci. Lett.* **196**(1–2), 61–64.
- Bagis, H., Odaman Mercan, H., and Dinnyes, A. (2004). Exposure to warmer postoperative temperatures reduces hypothermia caused by anaesthesia and significantly increases the implantation rate of transferred embryos in the mouse. *Lab. Anim.* **38**(1), 50–54.
- Barr, G.A. (1999). Antinociceptive effects of locally administered morphine in infant rats. *Pain* **81**(1–2), 155–161.
- Barrett, A.C., Smith, E.S., and Picker, M.J. (2002). Sex-related differences in mechanical nociception and antinociception produced by mu- and kappa-opioid receptor agonists in rats. *Eur. J. Pharmacol.* **452**(2), 163–173.
- Bartok, R.E., and Craft, R.M. (1997). Sex differences in opioid antinociception. *J. Pharmacol. Exp. Ther.* **282**(2), 769–778.
- Barzago, M.M., Bortolotti, A., Stellari, F.F., Pagani, C., Marraro, G., and Bonati, M. (1994). Respiratory and hemodynamic functions, blood-gas parameters, and acid–base balance of ketamine–xylazine anesthetized guinea pigs. *Lab. Anim. Sci.* **44**(6), 648–650.
- Bauer, D.J., Christenson, T.J., Clark, K.R., Powell, S.K., and Swain, R.A. (2003). Acetaminophen as a postsurgical analgesic in rats: A practical solution to neophobia. *Contemp. Top. Lab. Anim. Sci.* **42**(2), 20–25.
- Beagles, K., Wellstein, A., and Bayer, B. (2004). Systemic morphine administration suppresses genes involved in antigen presentation. *Mol. Pharmacol.* **65**(2), 437–442.
- Beiglböck, C., and Zenker, W. (2003). Evaluation of three combinations of anesthetics for use in free-ranging alpine marmots (*Marmota marmota*). *J. Wildl. Dis.* **39**(3), 665–674.
- Beirith, A., Santos, A.R., Rodrigues, A.L., Creczynski-Pasa, T.B., and Calixto, J.B. (1998). Spinal and supraspinal antinociceptive action of dipyrone in formalin, capsaicin and glutamate tests. Study of the mechanism of action. *Eur. J. Pharmacol.* **345**(3), 233–245.
- Bekker, A., Shah, R., Quatermain, D., Li, Y.S., and Blanck, T. (2006). Isoflurane preserves spatial working memory in adult mice after moderate hypoxia. *Anesth. Analg.* **102**(4), 1134–1138.
- Benesova, O., Tejkalova, H., Kristofikova, Z., Husek, P., Nedvidkova, J., and Yamamoto, A. (2001). Brain maldevelopment and neurobehavioural deviations in adult rats treated neonatally with indomethacin. *Eur. Neuropsychopharmacol.* **11**(5), 367–373.
- Ben-Nathan, D., Kobiler, D., Rzotkiewicz, S., Lustig, S., and Katz, Y. (2000). CNS penetration by noninvasive viruses following inhalational anesthetics. *Ann. N. Y. Acad. Sci.* **917**, 944–950.
- Bickler, P.E., and Fahlman, C.S. (2006). The inhaled anesthetic, isoflurane, enhances Ca²⁺-dependent survival signaling in cortical neurons and modulates MAP kinases, apoptosis proteins and transcription factors during hypoxia. *Anesth. Analg.* **103**(2), 419–429.
- Blais, V., Zhang, J., and Rivest, S. (2002). In altering the release of glucocorticoids, ketorolac exacerbates the effects of systemic immune stimuli on

- expression of proinflammatory genes in the brain. *Endocrinology* **143**(12), 4820–4827.
- Bohrer, H., Schmidt, H., Bach, A., Martin, E., Kohl, B., Bolsen, K., and Goerz, G. (1994). Porphyrinogenic effects of atracurium, vecuronium, and pancuronium in a primed rat model. *Lab. Anim. Sci.* **44**(4), 326–330.
- Bolan, E.A., Tallarida, R.J., and Pasternak, G.W. (2002). Synergy between mu opioid ligands: Evidence for functional interactions among mu opioid receptor subtypes. *J. Pharmacol. Exp. Ther.* **303**(2), 557–562.
- Borchar, R.E., Barnes, C.D., and Eltherington, L.G. (1992). "Introduction. Drug Dosage in Laboratory Animals: A Handbook." CRC Press, Boca Raton, FL, pp. ix–xviii.
- Brammer, A., West, C.D., and Allen, S.L. (1993). A comparison of propofol with other injectable anaesthetics in a rat model for measuring cardiovascular parameters. *Lab. Anim.* **27**(3), 250–257.
- Branson, K.R. (2001). Injectable anesthetics. In "Veterinary Pharmacology and Therapeutics." (H.R. Adams, ed.), 8th ed., pp. 213–268. Iowa State University Press, Ames, IA.
- Branson, K.R., and Gross, M.E. (2001). Opioid agonists and antagonists. In "Veterinary Pharmacology and Therapeutics." (H.R. Adams, ed.), pp. 268–298. Iowa State University Press, Ames, Iowa
- Briggs, S.L., Sawyer, D.C., Rech, R.H., and Galligan, J.J. (1995). Oxymorphone-induced analgesia and colonic motility measured in colorectal distension. *Pharmacol. Biochem. Behav.* **52**(3), 561–563.
- Brown, E.T., Umino, Y., Loi, T., Solessio, E., and Barlow, R. (2005). Anesthesia can cause sustained hyperglycemia in C57/BL6J mice. *Vis. Neurosci.* **22**(5), 615–618.
- Brown, J.N., Thorne, P.R., and Nuttall, A.L. (1989). Blood pressure and other physiological responses in awake and anesthetized guinea pigs. *Lab. Anim. Sci.* **39**(2), 142–148.
- Brown, K.M., Saunders, M.M., Kirsch, T., Donahue, H.J., and Reid, J.S. (2004). Effect of COX-2-specific inhibition on fracture-healing in the rat femur. *J. Bone Joint Surg. Am.* **86-A**(1), 116–123.
- Brown, R.H., Walters, D.M., Greenberg, R.S., and Mitzner, W. (1999). A method of endotracheal intubation and pulmonary functional assessment for repeated studies in mice. *J. Appl. Physiol.* **87**(6), 2362–2365.
- Browne, K.D., Iwata, A., Putt, M.E., and Smith, D.H. (2006). Chronic ibuprofen administration worsens cognitive outcome following traumatic brain injury in rats. *Exp. Neurol.* **201**(2), 301–307.
- Brown-Woodman, P.D., Ritchie, H.E., Korabelnikoff, A., and Emmanuel, C. (2004). Replacement of ether with alternate volatile anesthetics for collection of rat serum used in embryo culture. *Toxicol. In Vitro* **18**(5), 719–724.
- Bruguerolle, B., Giafre, E., and Prat, M. (1991). Temporal variations in transcutaneous passage of drugs: The example of lidocaine in children and in rats. *Chronobiol. Int.* **8**(4), 277–282.
- Brunson, D.B. (1997). "Anesthesia and Analgesia in Laboratory Animals: Pharmacology of Inhalation Anesthetics." Academic Press.
- Buelke-Sam, J., Holson, J.F., Bazare, J.J., and Young, J.F. (1978). Comparative stability of physiological parameters during sustained anesthesia in rats. *Lab. Anim. Sci.* **28**(2), 157–162.
- Buetow, B.S., Chen, L.I., Maggio-Price, L., and Swisshelm, K. (1999). Peritonitis in nude mice in a xenograft study. *Contemp. Top. Lab. Anim. Sci.* **38**(6), 47–49.
- Buzaleh, A.M., and Battle, A.M. (1996). Strain and sex differences in the effect of enflurane and isoflurane on heme metabolism in mice. *Gen. Pharmacol.* **27**(6), 1009–1012.
- Cadranel, J.F., Legendre, C., Desaint, B., Delamarre, N., Florent, C., and Levy, V.G. (1993). Liver disease from surreptitious administration of urethane. *J. Clin. Gastroenterol.* **17**(1), 52–56.
- Calcagnetti, D.J., Fleetwood, S.W., and Holtzman, S.G. (1990). Pharmacological profile of the potentiation of opioid analgesia by restraint stress. *Pharmacol. Biochem. Behav.* **37**(1) 193–199.
- Calderone, L., Grimes, P., and Shalev, M. (1986). Acute reversible cataract induced by xylazine and by ketamine–xylazine anesthesia in rats and mice. *Exp. Eye Res.* **42**(4), 331–337.
- Campos, A.R., Santos, F.A., and Rao, V.S. (2006). Ketamine-induced potentiation of morphine analgesia in rat tail-flick test: Role of opioid-, alpha2-adrenoceptors and ATP-sensitive potassium channels. *Biol. Pharm. Bull.* **29**(1), 86–89.
- Camprodon, R.A., and Bowles, M.J. (2006). Perioperative analgesia in experimental small bowel transplantation. *Transplant. Proc.* **38**(6), 1857–1858.
- Canto de Souza, A., Nunes de Souza, R.L., Pela, I.R., and Graeff, F.G. (1997). High intensity social conflict in the Swiss albino mouse induces analgesia modulated by 5-HT1A receptors. *Pharmacol. Biochem. Behav.* **56**(3) 481–486.
- Cantwell, S.L. (2001). Ferret, rabbit, and rodent anesthesia. *Vet. Clin. North Am. Exot. Anim. Pract.* **4**(1), 169–191.
- Capetola, R.J., Rosenthale, M.E., Dubinsky, B., and McGuire, J.L. (1983). Peripheral antialgesics: A review. *J. Clin. Pharmacol.* **23**(11–12), 545–556.
- Castonguay, A., Rioux, N., Duperron, C., and Jalbert, G. (1998). Inhibition of lung tumorigenesis by NSAIDS: A working hypothesis. *Exp. Lung Res.* **24**(4), 605–615.
- Ceccarelli, I., De Padova, A.M., Fiorenzani, P., Massafra, C., and Aloisi, A.M. (2006). Single opioid administration modifies gonadal steroids in both the CNS and plasma of male rats. *Neuroscience* **140**(3), 929–937.
- Celerier, E., Gonzalez, J.R., Maldonado, R., Cabanero, D., and Puig, M.M. (2006). Opioid-induced hyperalgesia in a murine model of postoperative pain: Role of nitric oxide generated from the inducible nitric oxide synthase. *Anesthesiology* **104**(3), 546–555.
- Celerier, E., Rivat, C., Jun, Y., Laulin, J.P., Larcher, A., Reynier, P., and Simonnet, G. (2000). Long-lasting hyperalgesia induced by fentanyl in rats: Preventive effect of ketamine. *Anesthesiology* **92**(2), 465–472.
- Cetin, N., Cetin, E., and Toker, M. (2005). Echocardiographic variables in healthy guinea pigs anaesthetized with ketamine–xylazine. *Lab. Anim.* **39**(1), 100–106.
- Chau, T.T., and Weichman, B.M. (1989). Pemedolac: A novel and long-acting non-narcotic analgesic. *J. Pharmacol. Exp. Ther.* **248**(3), 907–915.
- Chen, K.T., Hu, O.Y., Ho, S.T., Chen, Y.W., and Wang, J.J. (2002a). The analgesic effect of nalbuphine and its long-acting prodrug, nalbuphine pivalate, in rats. *Acta Anaesthesiol. Sin.* **40**(4), 191–195.
- Chen, N., Restivo, A., and Reiss, C.S. (2002b). Selective inhibition of COX-2 is beneficial to mice infected intranasally with VSV. *Prostaglandins Other Lipid Mediat.* **67**(2), 143–155.
- Child, K.J., Currie, J.P., and Davis, B. (1971). The pharmacological properties in animals of CT 1341 a new steroid anesthetic agent. *Br. J. Anesth.* **43**, 2–13.
- Choi, S.S., Lee, J.K., and Suh, H.W. (2001). Antinociceptive profiles of aspirin and acetaminophen in formalin, substance P and glutamate pain models. *Brain Res.* **921**(1–2), 233–239.
- Christoph, T., Kogel, B., Schiene, K., Meen, M., De Vry, J., and Friderichs, E. (2005). Broad analgesic profile of buprenorphine in rodent models of acute and chronic pain. *Eur. J. Pharmacol.* **507**(1–3), 87–98.
- Chu, D.K., Jordan, M.C., Kim, J.K., Couto, M.A., and Roos, K.P. (2006). Comparing isoflurane with tribromoethanol anesthesia for echocardiographic phenotyping of transgenic mice. *J. Am. Assoc. Lab. Anim. Sci.* **45**(4), 8–13.
- Cicero, T.J., Nock, B., O'Connor, L., and Meyer, E.R. (2002). Role of steroids in sex differences in morphine-induced analgesia: Activational and organizational effects. *J. Pharmacol. Exp. Ther.* **300**(2), 695–701.
- Clark, J.A., Jr., Myers, P.H., Goelz, M.F., Thigpen, J.E., and Forsythe, D.B. (1997). Pica behavior associated with buprenorphine administration in the rat. *Lab. Anim. Sci.* **47**(3), 300–303.
- Clark, M.D., Krugner-Higby, L., Smith, L.J., Heath, T.D., Clark, K.L., and Olson, D. (2004). Evaluation of liposome-encapsulated oxymorphone hydrochloride in mice after splenectomy. *Comp. Med.* **54**(5), 558–563.
- Clifford, D.H. (1984). Preanesthesia, anesthesia, analgesia and euthanasia. In "Laboratory Animal Medicine." (J.G. Fox, B.J. Cohen, and F.M. Loew, eds.), pp. 527–562. Academic Press, New York.
- Clowry, G.J., and Flecknell, P.A. (2000). The successful use of fentanyl/fluanisone ('Hypnorm') as an anaesthetic for intracranial surgery in neonatal rats. *Lab. Anim.* **34**(3), 260–264.

- Code of Federal Regulations (1997). Title 9: Animals and Animal Products; Chap. 1 Animal and Plant Health Inspection Service, United States Department of Agriculture; Policy #11, Painful Procedures, Office of the Federal Register, Washington, DC.
- Code of Federal Regulations (2000). Title 9: Animals and Animal Products; Chap. 1 Animal and Plant Health Inspection Service, United States Department of Agriculture; Policy #12, Alternatives to Painful Procedures, Office of the Federal Register, Washington, DC.
- Code of Federal Regulations (2002). Title 9, Animals and Animal Products, subchapter A, part 1–3. Animal Welfare Act. Washington, D.C.
- Cole, D.J., Marcantonio, S., and Drummond, J.C. (1990). Anesthetic requirement of isoflurane is reduced in spontaneously hypertensive and Wistar-Kyoto rats. *Lab. Anim. Sci.* **40**(5), 506–509.
- Colpaert, F.C. (1987). Evidence that adjuvant arthritis in the rat is associated with chronic pain. *Pain* **28**(2), 201–222.
- Colpaert, F.C., Meert, T., De Witte, P., and Schmitt, P. (1982). Further evidence validating adjuvant arthritis as an experimental model of chronic pain in the rat. *Life Sci.* **31**(1), 67–75.
- Colpaert, F.C., Tarayre, J.P., Alliaga, M., Bruins Slot, L.A., Attal, N., and Koek, W. (2001). Opiate self-administration as a measure of chronic nociceptive pain in arthritic rats. *Pain* **91**(1–2), 33–45.
- Craft, R.M. (2003). Sex differences in opioid analgesia: “From mouse to man”. *Clin. J. Pain* **19**(3), 175–186.
- Craft, R.M., and Bernal, S.A. (2001). Sex differences in opioid antinociception: Kappa and ‘mixed action’ agonists. *Drug Alcohol Depend.* **63**(3), 215–228.
- Craft, R.M., and McNeil, D.M. (2003). Agonist/antagonist properties of nalbuphine, butorphanol and (–)-pentazocine in male vs. female rats. *Pharmacol. Biochem. Behav.* **75**(1), 235–245.
- Crain, S.M., and Shen, K.F. (2001). Acute thermal hyperalgesia elicited by low-dose morphine in normal mice is blocked by ultra-low-dose naltrexone, unmasking potent opioid analgesia. *Brain Res.* **888**(1), 75–82.
- Crifo, S. (1975). Aspirin ototoxicity in the guinea pig. *ORL J. Otorhinolaryngol. Relat. Spec.* **37**(1), 27–34.
- Cruz, J.I., Loste, J.M., and Burzaco, O.H. (1998). Observations on the use of medetomidine/ketamine and its reversal with atipamezole for chemical restraint in the mouse. *Lab. Anim.* **32**(1), 18–22.
- Cunningham, M.G., and McKay, R.D. (1993). A hypothermic miniaturized stereotaxic instrument for surgery in newborn rats. *J. Neurosci. Methods* **47**(1–2), 105–114.
- Curl, J.L. (1988). Ketamine–xylazine anaesthesia in the Djungarian hamster (*Phodopus sungorus*). *Lab. Anim.* **22**(4), 309–312.
- Curl, J.L., and Peters, L.L. (1983). Ketamine hydrochloride and xylazine hydrochloride anaesthesia in the golden hamster (*Mesocricetus auratus*). *Lab. Anim.* **17**(4), 290–293.
- Dada, M.O., Campbell, G.T., Horacek, M.J., and Blake, C.A. (1992). Intraperitoneal injection of chloral hydrate causes intra-abdominal adhesions and unilateral testicular atrophy in golden Syrian hamsters. *Life Sci.* **51**(1), 29–35.
- Dalkara, T., Irikura, K., Huang, Z., Panahian, N., and Moskowitz, M.A. (1995). Cerebrovascular responses under controlled and monitored physiological conditions in the anesthetized mouse. *J. Cereb. Blood Flow Metab.* **15**(4), 631–638.
- D’Alleinne, C.P., and Mann, D.D. (1982). Evaluation of ketamine/xylazine anaesthesia in the guinea pig: Toxicological parameters. *Vet. Hum. Toxicol.* **24**(6), 410–412.
- D’Amato, F.R. (1998). Kin interaction enhances morphine analgesia in male mice. *Behav. Pharmacol.* **9**(4), 369–373.
- Danneman, P.J., and Mandrell, T.D. (1997). Evaluation of five agents/methods for anaesthesia of neonatal rats. *Lab. Anim. Sci.* **47**(4), 386–395.
- Davis, A., and Perkins, M.N. (1993). The effect of capsaicin and conventional analgesics in two models of monoarthritis in the rat. *Agents Actions* **38 Spec No.** C10-2.
- D’Elia, M., Patenaude, J., Hamelin, C., Garrel, D.R., and Bernier, J. (2003). No detrimental effect from chronic exposure to buprenorphine on corticosteroid-binding globulin and corticosterone immune parameters. *Clin. Immunol.* **109**(2), 179–187.
- Del Monte, M., Omini, C., and Subissi, A. (1990). Mechanism of the potentiation of neurally-induced bronchoconstriction by gallamine in the guinea-pig. *Br. J. Pharmacol.* **99**(3), 582–586.
- Diaz-Reval, M.I., Ventura-Martinez, R., Hernandez-Delgado, G.P., Dominguez-Ramirez, A.M., and Lopez-Munoz, F.J. (2001). Effect of caffeine on antinociceptive action of ketoprofen in rats. *Arch. Med. Res.* **32**(1) 13–20.
- Dimalculangan, D., Bendo, A.A., Sims, R., Cottrell, J.E., and Kass, I.S. (2006). Desflurane improves the recovery of the evoked postsynaptic population spike from CA1 pyramidal cells after hypoxia in rat hippocampal slices. *J. Neurosurg. Anesthesiol.* **18**(1), 78–82.
- Dingley, J., Tooley, J., Porter, H., and Thoresen, M. (2006). Xenon provides short-term neuroprotection in neonatal rats when administered after hypoxia-ischemia. *Stroke* **37**(2), 501–506.
- Dittmar, M.S., Fehm, N. P., Vatankhah, B., and Horn, M. (2004). Ketamine/xylazine anaesthesia for radiologic imaging of neurologically impaired rats: Dose response, respiratory depression, and management of complications. *Comp. Med.* **54**(6), 652–655.
- Doretto, M.C., Garcia-Cairasco, N., Pimenta, N.J., Souza, D.A., and Tatsuo, M.A. (1998). Dipyrone, a novel anticonvulsant agent? Insights from three experimental epilepsy models. *Neuroreport* **9**(10), 2415–2421.
- Dretchen, K., Ghoneim, M.M., and Long, J.P. (1971). The interaction of diazepam with myoneural blocking agents. *Anesthesiology* **34**(5), 463–468.
- Drobac, E., Durand, E., Laudenbach, V., Mantz, J., and Gallego, J. (2004). A simple method for short-term controlled anaesthesia in newborn mice. *Physiol. Behav.* **82**(2–3), 279–283.
- Dubois, M.A., Haertig, A.G., and Kuss, R. (1981). Renal transplantation in hamsters. *J. Microsurg.* **3**(2), 107–111.
- Dwyer, R.C., Rampil, I.J., Eger, E.I., II, and Bennett, H.L. (1994). The electroencephalogram does not predict depth of isoflurane anaesthesia. *Anesthesiology* **81**(2), 403–409.
- Easterly, M.E., Foltz, C.J., and Paulus, M.J. (2001). Body condition scoring: comparing newly trained scorers and micro-computed tomography imaging. *Lab. Anim. (NY)* **30**(3), 46–49.
- Ebert, B., Andersen, S., and Krosgaard-Larsen, P. (1995). Ketobemidone, methadone and pethidine are non-competitive N-methyl-D-aspartate (NMDA) antagonists in the rat cortex and spinal cord. *Neurosci. Lett.* **187**(3), 165–168.
- Efstathiou, J.A., Sampson, D.A., Levine, Z., Rohan, R.M., Zurakowski, D., Folkman, J., D’Amato, R.J., and Rupnick, M.A. (2005). Nonsteroidal anti-inflammatory drugs differentially suppress endometriosis in a murine model. *Fertil. Steril.* **83**(1), 171–181.
- Eger, R.P., and MacLeod, B.A. (1995). Anaesthesia by intravenous emulsified isoflurane in mice. *Can. J. Anaesth.* **42**(2), 173–176.
- Elena, G., Amerio, N., Ferrero, P., Bay, M.L., Valenti, J., Colucci, D., and Puig, N.R. (2003). Effects of repetitive sevoflurane anaesthesia on immune response, select biochemical parameters and organ histology in mice. *Lab. Anim.* **37**(3), 193–203.
- Elena, G., Puig, N.R., Bay, M.L., Urizar, L., Barragan, J., Comba, J., and Amerio, N. (1997). Inhalatory anaesthetic (halothane) associated changes in the immune response in mice. *Int. J. Immunopharmacol.* **19**(11–12), 699–707.
- El Mouedden, M., and Meert, T.F. (2005). Evaluation of pain-related behavior, bone destruction and effectiveness of fentanyl, sufentanil, and morphine in a murine model of cancer pain. *Pharmacol. Biochem. Behav.* **82**(1), 109–119.
- Engelhard, K., Werner, C., Reeker, W., Lu, H., Mollenberg, O., Mielke, L., and Kochs, E. (1999). Desflurane and isoflurane improve neurological outcome after incomplete cerebral ischaemia in rats. *Br. J. Anaesth.* **83**(3), 415–421.
- Engelhardt, G., Homma, D., Schlegel, K., Utzmann, R., and Schmitzler, C. (1995). Anti-inflammatory, analgesic, antipyretic and related properties of meloxicam, a new non-steroidal anti-inflammatory agent with favourable gastrointestinal tolerance. *Inflamm. Res.* **44**(10), 423–433.

- Epemolu, O., Bom, A., Hope, F., and Mason, R. (2003). Reversal of neuromuscular blockade and simultaneous increase in plasma rocuronium concentration after the intravenous infusion of the novel reversal agent Org 25969. *Anesthesiology* **99**(3), 632–637.
- Erbil, Y., Berber, E., Seven, R., Calis, A., Eminoglu, L., Kocak, M., and Bilgic, L. (1998). The effect of intestinal transit time on bacterial translocation. *Acta Chir. Belg.* **98**(6), 245–249.
- Erhan, E., Onal, A., Kocabas, S., Parlar, A., Yegul, I., and Kosay, S. (2005). Ondansetron does not block tramadol-induced analgesia in mice. *Methods Find. Exp. Clin. Pharmacol.* **27**(9), 629–632.
- Erichsen, H.K., Hao, J.X., Xu, X.J., and Blackburn-Munro, G. (2005). Comparative actions of the opioid analgesics morphine, methadone and codeine in rat models of peripheral and central neuropathic pain. *Pain* **116**(3), 347–358.
- Fagioli, S., Consorti, D., and Pavone, F. (1990). Age-related cholinergic drug effects on analgesia in two inbred strains of mice. *Brain Res.* **510**(1), 150–153.
- Fang, Z., Gong, D., Ionescu, P., Laster, M.J., Eger, E.I., II, and Kendig, J. (1997). Maturation decreases ethanol minimum alveolar anesthetic concentration (MAC) more than desflurane MAC in rats. *Anesth. Analg.* **84**(4), 852–858.
- Ferrari, L., Turrini, G., Rostello, C., Guidi, A., Casartelli, A., Piaia, A., and Sartori, M. (2005). Evaluation of two combinations of Domitor, Zoletil 100, and Euthatal to obtain long-term nonrecovery anesthesia in Sprague–Dawley rats. *Comp. Med.* **55**(3), 256–264.
- Field, K.J. (1988). The anesthetic effects of alpha chloralose, chloral hydrate, pentobarbital and urethane on the respiratory system, cardiovascular system, core temperature and noxious stimulus perception in adult male rats. In “The-sis in Laboratory Animal Medicine.” (P.A. Hershey, ed.), p 104. Pennsylvania State University, MS.
- Field, K.J., and Lang, C.M. (1988). Hazards of urethane (ethyl carbamate): A review of the literature. *Lab. Anim.* **22**(3), 255–262.
- Field, K.J., White, W.J., and Lang, C.M. (1993). Anaesthetic effects of chloral hydrate, pentobarbitone and urethane in adult male rats. *Lab. Anim.* **27**(3), 258–269.
- Filaretov, A.A., Bogdanov, A.I., and Yarushkina, N.I. (1996). Stress-induced analgesia. The role of hormones produced by the hypophyseal–adrenocortical system. *Neurosci. Behav. Physiol.* **26**(6), 572–578.
- File, S.E., and Simmonds, M.A. (1988). Myoclonic seizures in the mouse induced by alphaxalone and related steroid anaesthetics. *J. Pharm. Pharmacol.* **40**(1), 57–59.
- Finster, M., Morishima, H.O., Boyes, R.N., and Covino, B.G. (1972). The placental transfer of lidocaine and its uptake by fetal tissues. *Anesthesiology* **36**(2), 159–163.
- Fitzpatrick, L.R., Sakurai, K., and Le, T. (1999). Effect of naproxen on the hamster gastric antrum: ulceration, adaptation and efficacy of anti-ulcer drugs. *Aliment. Pharmacol. Ther.* **13**(11), 1553–1562.
- Flecknell, P.A. (1984). The relief of pain in laboratory animals. *Lab. Anim.* **18**(2), 147–160.
- Flecknell, P.A. (1987a). “Laboratory Animal Anaesthesia.” Academic Press, London, UK.
- Flecknell, P.A. (1987b). Laboratory mammal anesthesia. *J. Assoc. Vet. Anesth.* **14**, 111–119.
- Flecknell, P.A. (1993a). Anaesthesia of animals for biomedical research. *Br. J. Anaesth.* **71**(6), 885–894.
- Flecknell, P.A. (1993b). Anesthesia and perioperative care. *Methods Enzymol.* **225**, 16–33.
- Flecknell, P.A. (1996). “Laboratory Animal Anaesthesia: A Practical Introduction for Research Workers and Technicians.” Academic Press, London.
- Flecknell, P.A., and Liles, J.H. (1991). The effects of surgical procedures, halothane anaesthesia and nalbuphine on locomotor activity and food and water consumption in rats. *Lab. Anim.* **25**(1), 50–60.
- Flecknell, P.A., Liles, J.H., and Williamson, H.A. (1990). The use of lignocaine-prilocaine local anaesthetic cream for pain-free venepuncture in laboratory animals. *Lab. Anim.* **24**(2), 142–146.
- Flecknell, P.A., and Mitchell, M. (1984). Midazolam and fentanyl-fluanisone: Assessment of anaesthetic effects in laboratory rodents and rabbits. *Lab. Anim.* **18**(2), 143–146.
- Flecknell, P.A., Orr, H.E., Roughan, J.V., and Stewart, R. (1999a). Comparison of the effects of oral or subcutaneous carprofen or ketoprofen in rats undergoing laparotomy. *Vet. Rec.* **144**(3), 65–67.
- Flecknell, P.A., Roughan, J.V., and Stewart, R. (1999b). Use of oral buprenorphine (‘buprenorphine jello’) for postoperative analgesia in rats—A clinical trial. *Lab. Anim.* **33**(2), 169–174.
- Fleischman, R.W., McCracken, D., and Forbes, W. (1977). Adynamic ileus in the rat induced by chloral hydrate. *Lab. Anim. Sci.* **27**(2), 238–243.
- Flood, P., Sonner, J.M., Gong, D., and Coates, K.M. (2002). Isoflurane hyperalgesia is modulated in nicotinic inhibition. *Anesthesiology* **97**(1), 192–198.
- Forsythe, D.B., Payton, A.J., Dixon, D., Myers, P.H., Clark, J.A., and Snipe, J.R. (1992). Evaluation of Telazol–xylazine as an anesthetic combination for use in Syrian hamsters. *Lab. Anim. Sci.* **42**(5), 497–502.
- Frase, B.A., and Van Vuren, D. (1989). Techniques for immobilizing and bleeding marmosets and woodrats. *J. Wildl. Dis.* **25**(3), 444–445.
- Fu, E.S., and Scharf, J.E. (1995). The effect of pre-emptive fentanyl on formalin pain in mice. *Reg. Anesth.* **20**(4), 291–295.
- Furukawa, S., MacLennan, M.J., and Keller, B.B. (1998). Hemodynamic response to anesthesia in pregnant and nonpregnant ICR mice. *Lab. Anim. Sci.* **48**(4), 357–363.
- Gades, N.M., Danneman, P.J., Wixson, S.K., and Tolley, E.A. (2000). The magnitude and duration of the analgesic effect of morphine, butorphanol, and buprenorphine in rats and mice. *Contemp. Top. Lab. Anim. Sci.* **39**(2), 8–13.
- Gaertner, D.J., Boschert, K.R., and Schoeb, T.R. (1987). Muscle necrosis in Syrian hamsters resulting from intramuscular injections of ketamine and xylazine. *Lab. Anim. Sci.* **37**(1), 80–83.
- Gardner, D.J., Davis, J.A., Weina, P.J., and Theune, B. (1995). Comparison of tribromoethanol, ketamine/acetylpromazine, Telazol/xylazine, pentobarbital, and methoxyflurane anesthesia in HSD:ICR mice. *Lab. Anim. Sci.* **45**(2), 199–204.
- Gaveriaux-Ruff, C., Matthes, H.W., Peluso, J., and Kieffer, B.L. (1998). Abolition of morphine-immunosuppression in mice lacking the mu-opioid receptor gene. *Proc. Natl. Acad. Sci. USA* **95**(11), 6326–6330.
- Gawrisch, E., and Cheng, E.Y. (1990). Buprenorphine sedation of intensive care patients and ileus reversal. *Crit. Care Med.* **18**(9), 1034–1036.
- Genedani, S., Bernardi, M., and Bertolini, A. (1999). Influence of antineoplastic drugs on morphine analgesia and on morphine tolerance. *Eur. J. Pharmacol.* **367**(1), 13–17.
- Gibbs, N.M., Larach, D.R., and Schuler, H.G. (1989). The effect of neuromuscular blockade with vecuronium on hemodynamic responses to noxious stimuli in the rat. *Anesthesiology* **71**(2), 214–217.
- Gillingham, M.B., Clark, M.D., Dahly, E.M., Krugner-Higby, L.A., and Ney, D.M. (2001). A comparison of two opioid analgesics for relief of visceral pain induced by intestinal resection in rats. *Contemp. Top. Lab. Anim. Sci.* **40**(1), 21–26.
- Gilroy, B.A., and Varga, J.S. (1980). Use of ketamine–diazepam and ketamine–xylazine combinations in guinea pigs. *Vet. Med. Small Anim. Clin.* **75**(3), 508–509.
- Giraud, O., Mollieux, S., Rolland, C., Lecon-Malas, V., Desmots, J.M., Aubier, M., and Dehoux, M. (2003). Halogenated anesthetics reduce interleukin-1beta-induced cytokine secretion by rat alveolar type II cells in primary culture. *Anesthesiology* **98**(1), 74–81.
- Giraud, O., Seince, P.F., Rolland, C., Lecon-Malas, V., Desmots, J.M., Aubier, M., and Dehoux, M. (2000). Halothane reduces the early lipopolysaccharide-induced lung inflammation in mechanically ventilated rats. *Am. J. Respir. Crit. Care Med.* **162**(6), 2278–2286.
- Glen, J.B. (1980). Animal studies of the anaesthetic activity of ICI 35 868. *Br. J. Anaesth.* **52**(8), 731–742.

- Goecke, J.C., Awad, H., Lawson, J.C., and Boivin, G.P. (2005). Evaluating postoperative analgesics in mice using telemetry. *Comp. Med.* **55**(1), 37–44.
- Gong, D.H., Weiskopf, R.B., Neumann, M.A., Laster, M.J., and Eger, E.I. (1998). In rats breathing from a nonbreathing system, substitution of desflurane for isoflurane toward the end of anesthesia incompletely restores the time of recovery toward that of desflurane. *Anesth. Analg.* **86**(1), 198–201.
- Gonzalez, M.I., Field, M. J., Bramwell, S., McCleary, S., and Singh, L. (2000). Ovariohysterectomy in the rat: A model of surgical pain for evaluation of pre-emptive analgesia? *Pain* **88**(1), 79–88.
- Gopalan, C., Hegade, G.M., Bay, T.N., Brown, S.R., and Talcott, M.R. (2005). Tribromoethanol–medetomidine combination provides a safe and reversible anesthetic effect in Sprague–Dawley rats. *Contemp. Top. Lab. Anim. Sci.* **44**(1), 7–10.
- Goren, S., Kahveci, N., Alkan, T., Goren, B., and Korfali, E. (2001). The effects of sevoflurane and isoflurane on intracranial pressure and cerebral perfusion pressure after diffuse brain injury in rats. *J. Neurosurg. Anesthesiol.* **13**(2), 113–119.
- Goto, T., Marota, J.J., and Crosby, G. (1996). Volatile anaesthetics antagonize nitrous oxide and morphine-induced analgesia in the rat. *Br. J. Anaesth.* **76**(5), 702–706.
- Gotoh, H., Matsumoto, Y., and Imamura, K. (2004). General anesthesia of infant mice by isoflurane inhalation for medium-duration surgery. *Exp. Anim.* **53**(1), 63–65.
- Gourine, A.V., Atkinson, L., Deuchars, J., and Spyer, K.M. (2003). Purinergic signalling in the medullary mechanisms of respiratory control in the rat: Respiratory neurones express the P2X2 receptor subunit. *J. Physiol.* **552**(Pt 1), 197–211.
- Graham, M.D., Bru-Mercier, G., Hopkins, P.M., and Harrison, S.M. (2004). Effects of halothane, isoflurane, and sevoflurane on contraction and calcium transients in ventricular myocytes from normotensive and spontaneously hypertensive rats. *Biophys. J.* **86**(1), 48a–49a.
- Granados-Soto, V., and Flores-Murrieta, F.J. (1995). Pharmacokinetics of oral ketorolac in the rat. *Methods Find. Exp. Clin. Pharmacol.* **17**(8), 535–538.
- Green, C.J. (1975). Neuroleptanalgesic drug combinations in the anaesthetic management of small laboratory animals. *Lab. Anim.* **9**(3), 161–178.
- Green, C.J., Halsey, M.J., Precious, S., and Wardley-Smith, B. (1978). Alphaxolone–alphadolone anaesthesia in laboratory animals. *Lab. Anim.* **12**(2), 85–89.
- Green, C.J., Knight, J., Precious, S., and Simpkin, S. (1981). Ketamine alone and combined with diazepam or xylazine in laboratory animals: A 10 year experience. *Lab. Anim.* **15**(2), 163–170.
- Greenwood-Van Meerveld, B., Gardner, C.J., Little, P.J., Hicks, G.A., and Dehaven-Hudkins, D.L. (2004). Preclinical studies of opioids and opioid antagonists on gastrointestinal function. *Neurogastroenterol. Motil.* **16**(Suppl. 2), 46–53.
- Gringauz, M., Rabinowitz, R., Stav, A., and Korczyn, A.D. (2001). Tolerance to the analgesic effect of buprenorphine, butorphanol, nalbuphine, and cyclorphan, and cross-tolerance to morphine. *J. Anesth.* **15**(4), 204–209.
- Groeben, H., Meier, S., Tankersley, C.G., Mitzner, W., and Brown, R.H. (2003). Heritable differences in respiratory drive and breathing pattern in mice during anaesthesia and emergence. *Br. J. Anaesth.* **91**(4), 541–545.
- Gross, M.E. (2001). Tranquilizers, alpha-2-adrenergic agonists, and related agents. In “Veterinary pharmacology and therapeutics.” (H.R. Adams, ed.), 8th ed., pp. 299–343. Iowa State University Press, Ames, IA.
- Gultekin, H., Yildiz, K., Sezer, Z., and Dogru, K. (2006). Comparing the relaxing effects of desflurane and sevoflurane on oxytocin-induced contractions of isolated myometrium in both pregnant and nonpregnant rats. *Adv. Ther.* **23**(1), 39–46.
- Gupta, A., Cheng, J., Wang, S., and Barr, G.A. (2001). Analgesic efficacy of ketorolac and morphine in neonatal rats. *Pharmacol. Biochem. Behav.* **68**(4), 635–640.
- Gupta, S.K., Bansal, P., Bhardwaj, R.K., Jaiswal, J., and Velpandian, T. (2002). Comparison of analgesic and anti-inflammatory activity of meloxicam gel with diclofenac and piroxicam gels in animal models: Pharmacokinetic parameters after topical application. *Skin Pharmacol. Appl. Skin Physiol.* **15**(2), 105–111.
- Gurtu, S., Shukla, S., and Mukerjee, D. (1994). Morphine, clonidine coadministration in subanalgesic doses: Effective control of tonic pain. *Neuroreport* **5**(6), 715–717.
- Haberham, Z.L., van den Brom, W.E., Venker-van Haagen, A.J., Baumans, V., de Groot, H.N., and Hellebrekers, L.J. (1999). EEG evaluation of reflex testing as assessment of depth of pentobarbital anaesthesia in the rat. *Lab. Anim.* **33**(1), 47–57.
- Hacker, S.O., White, C.E., Black, I.H. (2005). A comparison of target-controlled infusion versus volatile inhalant anesthesia for heart rate, respiratory rate, and recovery time in a rat model. *Contemp. Top. Lab. Anim. Sci.* **44**(5), 7–12.
- Haelewyn, B., Zhu, L., Hanouz, J.L., Persehaye, E., Roussel, S., Ducouret, P., and Gerard, J.L. (2004). Cardioprotective effects of desflurane: Effect of timing and duration of administration in rat myocardium. *Br. J. Anaesth.* **92**(4), 552–557.
- Hahn, N., Eisen, R.J., Eisen, L., and Lane, R.S. (2005). Ketamine–medetomidine anesthesia with atipamezole reversal: Practical anesthesia for rodents under field conditions. *Lab. Anim. (NY)* **34**(2), 48–51.
- Hall, L.W., Clarke, K.W., Trim, C.M. (2001a). General pharmacology of the injectable agents used in anesthesia. In “Veterinary Anaesthesia.” pp. 113–129. W.B. Saunders, London, England.
- Hall, L.W., Clarke, K.W., Trim, C.M. (2001b). Anaesthesia of birds, laboratory animals and wild animals. In “Veterinary Anaesthesia.” pp. 463–478. W.B. Saunders, London, England.
- Hall, T.J., Jagher, B., Schaeublin, M., and Wiesenberg, I. (1996). The analgesic drug buprenorphine inhibits osteoclastic bone resorption in vitro, but is proinflammatory in rat adjuvant arthritis. *Inflamm. Res.* **45**(6), 299–302.
- Hamura, H., Yoshida, M., Shimizu, K., Matsukura, T., Suzuki, H., Narita, M., and Suzuki, T. (2000). Antinociceptive effect of the combination of pentazocine with morphine in the tail-immersion and scald-pain tests in rats. *Jpn. J. Pharmacol.* **83**(4), 286–292.
- Hanson, C.E., Ruble, G.R., Essiet, I., and Hartman, A.B. (2001). Effects of buprenorphine on immunogenicity and protective efficacy in the guinea pig keratoconjunctivitis model (Sereny test). *Comp. Med.* **51**(3), 224–229.
- Haque, S.F., Izumi, S., Aikawa, H., Suzuki, T., Matsubayashi, H., Murano, T., Kika, G., Ikeda, M., Goya, K., and Makino, T. (2004). Anesthesia and acoustic stress-induced intra-uterine growth retardation in mice. *J. Reprod. Dev.* **50**(2), 185–190.
- Harkness, J.E., and Wagner, J.E. (1995). “The Biology and Medicine of Rabbits and Rodents.” Williams & Wilkins, Baltimore.
- Hart, M.V., Rowles, J.R., Hohimer, A.R., Morton, M.J., and Hosenpud, J.D. (1984). Hemodynamics in the guinea pig after anesthetization with ketamine/xylazine. *Am. J. Vet. Res.* **45**(11), 2328–2330.
- Haseneder, R., Kurz, J., Dodt, H.U., Kochs, E., Zieglgansberger, W., Scheller, M., Rammes, G., and Hapfelmeier, G. (2004). Isoflurane reduces glutamatergic transmission in neurons in the spinal cord superficial dorsal horn: Evidence for a presynaptic site of an analgesic action. *Anesth. Analg.* **98**(6), 1718–1723.
- Hasirci, V., Bonney, I., Goudas, L.C., Shuster, L., Carr, D.B., and Wise, D.L. (2003). Antihyperalgesic effect of simultaneously released hydromorphone and bupivacaine from polymer fibers in the rat chronic constriction injury model. *Life Sci.* **73**(26), 3323–3337.
- Hassan, H.G., Pilcher, C.W., Akerman, B., and Renck, H. (1989). Antinociceptive effects of localized administration of opioids compared with lidocaine. *Reg. Anesth.* **14**(3), 138–144.
- Hassan, H.G., Youssef, H., and Renck, H. (1993). Duration of experimental nerve block by combinations of local anesthetic agents. *Acta Anaesthesiol. Scand.* **37**(1), 70–74.
- Hawk, C.T., Leary, S.L., and Morris, T.H. (2005). “Formulary for Laboratory Animals.” Blackwell Publishing, Ames, IA.
- Hayashi, H., Dikkes, P., and Soriano, S.G. (2002). Repeated administration of ketamine may lead to neuronal degeneration in the developing rat brain. *Paediatr. Anaesth.* **12**(9), 770–774.

- Hayes, J.H., and Flecknell, P.A. (1999). A comparison of pre- and post-surgical administration of bupivacaine or buprenorphine following laparotomy in the rat. *Lab. Anim.* **33**(1), 16–23.
- Hayes, K.E., Raucci, J.A., Jr., Gades, N.M., and Toth, L.A. (2000). An evaluation of analgesic regimens for abdominal surgery in mice. *Contemp. Top. Lab. Anim. Sci.* **39**(6), 18–23.
- Hayton, S.M., Kriss, A., and Muller, D.P. (1999). Comparison of the effects of four anaesthetic agents on somatosensory evoked potentials in the rat. *Lab. Anim.* **33**(3), 243–251.
- Heard, D.J. (2004). “Anesthesia, Analgesia, and Sedation of Small Mammals.” Saunders, St. Louis, MO.
- Heavner, J.E. (1997). “Anesthesia and Analgesia in Laboratory Animals: Pharmacology of Analgesics.” (Kohn, D.F., Wixson, S.K., White, W.J., Benson, G.J., eds.), American College of Laboratory Animal Medicine Series. Academic Press, San Diego.
- Heavner, J.E. (2001). Anesthesia update: Agents, definitions, and strategies. *Comp. Med.* **51**(6), 500–503.
- Hedenqvist, P., Roughan, J.V., and Flecknell, P.A. (2000a). Effects of repeated anaesthesia with ketamine/medetomidine and of pre-anaesthetic administration of buprenorphine in rats. *Lab. Anim.* **34**(2), 207–211.
- Hedenqvist, P., Roughan, J.V., and Flecknell, P.A. (2000b). Sufentanil and medetomidine anaesthesia in the rat and its reversal with atipamezole and butorphanol. *Lab. Anim.* **34**(3), 244–251.
- Henke, J., Baumgartner, C., Roltgen, I., Eberspacher, E., and Erhardt, W. (2004). Anaesthesia with midazolam/medetomidine/fentanyl in chinchillas (*Chinchilla lanigera*) compared to anaesthesia with xylazine/ketamine and medetomidine/ketamine. *J. Vet. Med. A Physiol. Pathol. Clin. Med.* **51**(5), 259–264.
- Henning, R.H., Nelemans, A., Houwertjes, M., and Agoston, S. (1993). Reversal by suramin of neuromuscular block produced by pancuronium in the anaesthetized rat. *Br. J. Pharmacol.* **108**(3), 717–720.
- Hernandez-Delgado, G.P., and Cruz, S.L. (2004). Dipyrone potentiates morphine-induced antinociception in dipyrone-treated and morphine-tolerant rats. *Eur. J. Pharmacol.* **502**(1–2), 67–73.
- Hernandez-Delgado, G.P., and Cruz, S.L. (2006). Endogenous opioids are involved in morphine and dipyrone analgesic potentiation in the tail flick test in rats. *Eur. J. Pharmacol.* **546**(1–3), 54–59.
- Hernandez-Delgado, G.P., Lopez-Munoz, F.J., Salazar, L.A., and Cruz, S.L. (2003). Morphine and dipyrone co-administration delays tolerance development and potentiates antinociception. *Eur. J. Pharmacol.* **469**(1–3), 71–79.
- Hernandez-Delgado, G.P., Ventura Martinez, R., Diaz Reval, M.I., Dominguez Ramirez, A.M., and Lopez-Munoz, F.J. (2002). Metamizol potentiates morphine antinociception but not constipation after chronic treatment. *Eur. J. Pharmacol.* **441**(3), 177–183.
- Herrero, J.F., and Headley, P.M. (1996). Reversal by naloxone of the spinal antinociceptive actions of a systemically-administered NSAID. *Br. J. Pharmacol.* **118**(4), 968–972.
- Hertl, M.C., Hagberg, P.K., Hunter, D. A., Mackinnon, S.E., and Langer, J.C. (1998). Intrafascicular injection of ammonium sulfate and bupivacaine in peripheral nerves of neonatal and juvenile rats. *Reg. Anesth. Pain Med.* **23**(2), 152–158.
- Hildebrand, S.V. (1997). “Paralytic Agents.” Academic Press, San Diego.
- Hirst, M., Kavaliers, M., and Teskey, G.C. (1984). Age and day-night changes in clonidine-induced analgesia in mice. *Can. J. Physiol. Pharmacol.* **62**(9), 1102–1105.
- Hoar, R.M. (1969). Anesthesia in the guinea pig. *Fed. Proc.* **28**(4), 1517–1521.
- Hockertz, S., and Heckenberger, R. (1996). Treatment of an acute bacterial infection with a combination of acetylsalicylic acid/ibuprofen and interferon gamma. *Arzneimittelforschung* **46**(10), 1012–1015.
- Hoff, J.B., Dysko, R., Kurachi, S., and Kurachi, K. (2006). Technique for performance and evaluation of parapharyngeal hypophysectomy in mice. *J. Am. Assoc. Lab. Anim. Sci.* **45**(2), 57–62.
- Hrapkiewicz, K.L., Stein, S., and Smiler, K.L. (1989). A new anesthetic agent for use in the gerbil. *Lab. Anim. Sci.* **39**(4), 338–341.
- Hsu, W.H. (1982). Xylazine-induced delay of small intestinal transit in mice. *Eur. J. Pharmacol.* **83**(1–2), 55–60.
- Hsu, W.H., Bellin, S.I., Dellmann, H.D., and Hanson, C.E. (1986). Xylazine-ketamine-induced anesthesia in rats and its antagonism by yohimbine. *J. Am. Vet. Med. Assoc.* **189**(9), 1040–1043.
- Hu, C., Flecknell, P.A., and Liles, J.H. (1992). Fentanyl and medetomidine anaesthesia in the rat and its reversal using atipamezole and either nalbuphine or butorphanol. *Lab. Anim.* **26**(1), 15–22.
- Hu, G., Vasiliauskas, T., Salem, M.R., Rhone, D.P., and Crystal, G.J. (2003). Neutrophils pretreated with volatile anesthetics lose ability to cause cardiac dysfunction. *Anesthesiology* **98**(3) 712–718.
- Huang, C., Wang, Y., Chang, J.K., and Han, J.S. (2000). Endomorphin and mu-opioid receptors in mouse brain mediate the analgesic effect induced by 2 Hz but not 100 Hz electroacupuncture stimulation. *Neurosci. Lett.* **294**(3), 159–162.
- Huang, C., Wang, Y., Han, J.S., and Wan, Y. (2002). Characteristics of electroacupuncture-induced analgesia in mice: Variation with strain, frequency, intensity and opioid involvement. *Brain Res.* **945**(1), 20–25.
- Huang, Y., and Zuo, Z. (2005). Effects of isoflurane on oxygen-glucose deprivation-induced changes of gene expression profiling in glial-neuronal cocultures. *Acta Anaesthesiol. Scand.* **49**(10), 1544–1551.
- Hughes, E.W., Martin-Body, R.L., Sarelius, I.H., and Sinclair, J.D. (1982). Effects of urethane-chloralose anaesthesia on respiration in the rat. *Clin. Exp. Pharmacol. Physiol.* **9**(2), 119–127.
- Iltis, I., Kober, F., Dalmaso, C., Lan, C., Cozzone, P.J., and Bernard, M. (2005). In vivo assessment of myocardial blood flow in rat heart using magnetic resonance imaging: effect of anesthesia. *J. Magn. Reson. Imaging* **22**(2), 242–247.
- Imai, T., Takahashi, K., Mauso, F., and Goto, F. (1998). Anaesthesia affects outcome of sepsis in mice. *Can. J. Anaesth.* **45**(4), 360–366.
- Ingalls, C.P., Warren, G.L., Lowe, D.A., Boorstein, D.B., and Armstrong, R.B. (1996). Differential effects of anesthetics on in vivo skeletal muscle contractile function in the mouse. *J. Appl. Physiol.* **80**(1), 332–340.
- Institute for Laboratory Animal Research (U.S.) (ILAR). Commission on Life Sciences, N. R. C. U. S. (1996). “Guide for the Care and Use of Laboratory Animals.” National Academy Press, Washington, D.C.
- Institute for Laboratory Animal Research (U.S.) (ILAR). Committee on Guidelines for the Use of Animals in Neuroscience and Behavioral Research and N. R. Council (2003). “Guidelines for the Care and Use of Mammals in Neuroscience and Behavioral Research.” National Academy Press, Washington, D.C.
- Institute for Laboratory Animal Research (U.S.) (ILAR). Committee on Pain and Distress in Laboratory Animals, N. R. C. (1992). “Recognition and Alleviation of Pain and Distress in Laboratory Animals.” National Academy Press, Washington, D.C.
- IRAC (1985). U.S. Government Principles for the Utilization and Care of Vertebrate Animals Used in Testing, Research, and Training. 50FR20864. Office of Science and Technology Policy, Washington, D.C.
- Jablonski, P., and Howden, B.O. (2002). Oral buprenorphine and aspirin analgesia in rats undergoing liver transplantation. *Lab. Anim.* **36**(2), 134–143.
- Jablonski, P., Howden, B.O., and Baxter, K. (2001). Influence of buprenorphine analgesia on post-operative recovery in two strains of rats. *Lab. Anim.* **35**(3), 213–222.
- Jacobsen, K.O., Villa, V., Miner, V.L., and Whitnall, M.H. (2004). Effects of anesthesia and vehicle injection on circulating blood elements in C3H/HeN male mice. *Contemp. Top. Lab. Anim. Sci.* **43**(5), 8–12.
- Jacobson, C. (2000). Adverse effects on growth rates in rats caused by buprenorphine administration. *Lab. Anim.* **34**(2), 202–206.
- Jacobson, C. (2001). A novel anaesthetic regimen for surgical procedures in guinea pigs. *Lab. Anim.* **35**(3), 271–276.
- Jain, N.K., Kulkarni, S.K., and Singh, A. (2002). Modulation of NSAID-induced antinociceptive and anti-inflammatory effects by alpha2-adrenoceptor agonists with gastroprotective effects. *Life Sci.* **70**(24), 2857–2869.

- Jain, S., Jain, N., Bhadra, D., Tiwary, A.K., and Jain, N.K. (2005). Transdermal delivery of an analgesic agent using elastic liposomes: preparation, characterization and performance evaluation. *Curr. Drug Deliv.* **2**(3), 223–233.
- Jang, S., Kim, H., Kim, D., Jeong, M.W., Ma, T., Kim, S., Ho, I. K., and Oh, S. (2006). Attenuation of morphine tolerance and withdrawal syndrome by coadministration of nalbuphine. *Arch. Pharm. Res.* **29**(8), 677–684.
- Janicki, P.K., Horn, J.L., Singh, G., Franks, W.T., Janson, V.E., and Franks, J.J. (1996). Increased anesthetic requirements for isoflurane, halothane, enflurane and desflurane in obese Zucker rats are associated with insulin-induced stimulation of plasma membrane Ca(2+)-ATPase. *Life Sci.* **59**(17), PL269–PL275.
- Janssen, B.J., De Celle, T., Debets, J.J., Brouns, A.E., Callahan, M.F., and Smith, T.L. (2004). Effects of anesthetics on systemic hemodynamics in mice. *Am. J. Physiol. Heart Circ. Physiol.* **287**(4), H1618–H1624.
- Jaquenod, M., Ronnhedh, C., Cousins, M.J., Eckstein, R.P., Jordan, V., Mather, L.E., and Power, I. (1998). Factors influencing ketorolac-associated perioperative renal dysfunction. *Anesth. Analg.* **86**(5), 1090–1097.
- Jauchem, J.R., and Frei, M.R. (1991). Cardiovascular changes in unanesthetized and ketamine-anesthetized Sprague–Dawley rats exposed to 2.8-GHz radiofrequency radiation. *Lab. Anim. Sci.* **41**(1), 70–75.
- Javan, M., Kazemi, B., Ahmadiani, A., and Motamedi, F. (2006). Dexamethasone mimics the inhibitory effect of chronic pain on the development of tolerance to morphine analgesia and compensates for morphine induced changes in G proteins gene expression. *Brain Res.* **1104**(1), 73–79.
- Ji, Y., Murphy, A.Z., and Traub, R.J. (2006). Sex differences in morphine-induced analgesia of visceral pain are supraspinally and peripherally mediated. *Am. J. Physiol. Regul. Integr. Comp. Physiol.* **291**(2), R307–R314.
- Jobin, N., Garrel, D.R., and Bernier, J. (2000). Increased burn-induced immunosuppression in lipopolysaccharide-resistant mice. *Cell Immunol.* **200**(2), 65–75.
- Johansen, O., Vaaler, S., Jorde, R., and Reikeras, O. (1994). Increased plasma glucose levels after Hypnorm anaesthesia, but not after pentobarbital anaesthesia in rats. *Lab. Anim.* **28**(3), 244–248.
- Jong, W.M., Zuurbier, C.J., De Winter, R.J., Van Den Heuvel, D.A., Reitsma, P.H., Ten Cate, H., and Ince, C. (2002). Fentanyl-fluanisone-midazolam combination results in more stable hemodynamics than does urethane alpha-chloralose and 2,2,2-tribromoethanol in mice. *Contemp. Top. Lab. Anim. Sci.* **41**(3), 28–32.
- Joshi, S.K., Hernandez, G., Mikusa, J.P., Zhu, C.Z., Zhong, C., Salyers, A., Wismer, C.T., Chandran, P., Decker, M.W., and Honore, P. (2006). Comparison of antinociceptive actions of standard analgesics in attenuating capsaicin and nerve-injury-induced mechanical hypersensitivity. *Neuroscience* **143**(2), 587–596.
- Jou, I.M., Tsai, Y.T., Tsai, C.L., Wu, M.H., Chang, H.Y., and Wang, N.S. (2000). Simplified rat intubation using a new oropharyngeal intubation wedge. *J. Appl. Physiol.* **89**(5), 1766–1770.
- Jungwirth, B., Gordan, M.L., Biobner, M., Schmehl, W., Kochs, E.F., and Mackensen, G.B. (2006). Xenon impairs neurocognitive and histologic outcome after cardiopulmonary bypass combined with cerebral air embolism in rats. *Anesthesiology* **104**(4), 770–776.
- Kahveci, F.S., Kahveci, N., Alkan, T., Goren, B., Korfali, E., and Ozluk, K. (2001). Propofol versus isoflurane anesthesia under hypothermic conditions; effects on intracranial pressure and local cerebral blood flow after diffuse traumatic brain injury in the rat. *Surg. Neurol.* **56**(3), 206–214.
- Kalinichev, M., Easterling, K.W., and Holtzman, S.G. (2001). Early neonatal experience of Long-Evans rats results in long-lasting changes in morphine tolerance and dependence. *Psychopharmacology (Berl)* **157**(3), 305–312.
- Kanaan, S.A., Safieh-Garabedian, B., Haddad, J.J., Atweh, S.F., Abdelnoor, A.M., Jabbur, S.J., and Saade, N.E. (1997). Effects of various analgesic and anti-inflammatory drugs on endotoxin-induced hyperalgesia in rats and mice. *Pharmacology* **54**(6), 285–297.
- Kanarek, R.B., Przypek, J., D’Anci, K.E., and Marks-Kaufman, R. (1997). Dietary modulation of mu and kappa opioid receptor-mediated analgesia. *Pharmacol. Biochem. Behav.* **58**(1), 43–49.
- Kandatsu, N., Nan, Y.S., Feng, G.G., Nishiwaki, K., Hirokawa, M., Ishikawa, K., Komatsu, T., Yokochi, T., Shimada, Y., and Ishikawa, N. (2005). Opposing effects of isoflurane and sevoflurane on neurogenic pulmonary edema development in an animal model. *Anesthesiology* **102**(6), 1182–1189.
- Kanui, T.I., and Hole, K. (1990). Morphine induces aggression but not analgesia in the naked mole-rat (*Heterocephalus glaber*). *Comp. Biochem. Physiol. C* **96**(1), 131–133.
- Karas, A.Z. (2002). Postoperative analgesia in the laboratory mouse, *Mus musculus*. *Lab. Anim. (NY)* **31**(7), 49–52.
- Karuri, A.R., Engelking, L.R., and Kumar, M.S. (1998). Effects of halothane and methoxyflurane on the hypothalamic–pituitary–adrenal axis in rat. *Brain Res. Bull.* **47**(3), 205–209.
- Kashimoto, S., Furuya, A., Nonaka, A., Oguchi, T., Koshimizu, M., and Kumazawa, T. (1997). The minimum alveolar concentration of sevoflurane in rats. *Eur. J. Anaesthesiol.* **14**(4), 359–361.
- Kastl, S., Kotschenreuther, U., Hille, B., Schmidt, J., Gepp, H., and Hohenberger, W. (2004). Simplification of rat intubation on inclined metal plate. *Adv. Physiol. Educ.* **28**(1–4), 29–32.
- Katz, Y., Lustig, S., Ben-Shlomo, I., Kobiler, D., and Ben-Nathan, D. (2002). Inhalation anesthetic-induced neuroinvasion by an attenuated strain of West Nile virus in mice. *J. Med. Virol.* **66**(4), 576–580.
- Kavaliers, M., Colwell, D.D., and Perrot-Sinal, T.S. (1997). Opioid and non-opioid NMDA-mediated predator-induced analgesia in mice and the effects of parasitic infection. *Brain Res.* **766**(1–2), 11–18.
- Kawaguchi, M., Drummond, J.C., Cole, D.J., Kelly, P.J., Spurlock, M.P., and Patel, P.M. (2004). Effect of isoflurane on neuronal apoptosis in rats subjected to focal cerebral ischemia. *Anesth. Analg.* **98**(3), 798–805, Table of Contents.
- Kayser, V., Besson, J.M., and Guilbaud, G. (1991). Effects of the analgesic agent tramadol in normal and arthritic rats: Comparison with the effects of different opioids, including tolerance and cross-tolerance to morphine. *Eur. J. Pharmacol.* **195**(1), 37–45.
- Keller, C., Grimm, C., Wenzel, A., Hafezi, F., and Reme, C. (2001). Protective effect of halothane anesthesia on retinal light damage: inhibition of metabolic rhodopsin regeneration. *Invest. Ophthalmol. Vis. Sci.* **42**(2), 476–480.
- Kennedy, B.W. (2002). Creating a training coordinator position. *Lab. Anim. (NY)* **31**(6), 34–38.
- Kest, B., Wilson, S.G., and Mogil, J.S. (1999). Sex differences in supraspinal morphine analgesia are dependent on genotype. *J. Pharmacol. Exp. Ther.* **289**(3), 1370–1375.
- Kharasch, E.D., and Jubert, C. (1999). Compound A uptake and metabolism to mercapturic acids and 3,3,3-trifluoro-2-fluoromethoxypropanoic acid during low-flow sevoflurane anesthesia: Biomarkers for exposure, risk assessment, and interspecies comparison. *Anesthesiology* **91**(5), 1267–1278.
- Kharasch, E.D., Schroeder, J.L., Bammler, T., Beyer, R., and Srinouprachanh, S. (2006). Gene expression profiling of nephrotoxicity from the sevoflurane degradation product fluoromethyl-2,2-difluoro-1-(trifluoromethyl) vinyl ether (“compound A”) in rats. *Toxicol. Sci.* **90**(2), 419–431.
- Kiatchoosakun, S., Kirkpatrick, D., and Hoit, B.D. (2001). Effects of tribromoethanol anesthesia on echocardiographic assessment of left ventricular function in mice. *Comp. Med.* **51**(1), 26–29.
- Kilgore, J.L., Ross, C.R., and Saunders, D.K. (2003). Potential effects of anesthetic agents on heat shock proteins in the laboratory rat. *Tex. J. Sci.* **55**(2), 149–158.
- Kim, H., Oh, E., Im, H. Mun, J., Yang, M., Khim, J.Y., Lee, E., Lim, S.H., Kong, M. H., Lee, M., et al. (2006). Oxidative damages in the DNA, lipids, and proteins of rats exposed to isofluranes and alcohols. *Toxicology* **220**(2–3), 169–178.
- Kim, T., Murdande, S., Gruber, A., and Kim, S. (1996). Sustained-release morphine for epidural analgesia in rats. *Anesthesiology* **85**(2), 331–338.
- Kipp, D.E., Fox, L.M., and Levy, J.A. (1989). The influence of anesthesia and surgery on plasma cortisol and tissue ascorbic acid levels in the guinea pig. *Int. J. Vitam. Nutr. Res.* **59**(2), 172–179.

- Kirsch, J.H., Klaus, J.A., Blizzard, K.K., Hurn, P.D., and Murphy, S.J. (2002). Pain evaluation and response to buprenorphine in rats subjected to sham middle cerebral artery occlusion. *Contemp. Top. Lab. Anim. Sci.* **41**(6), 9–14.
- Kissin, I., Lee, S.S., Arthur, G.R., and Bradley, E.L., Jr. (1996). Time course characteristics of acute tolerance development to continuously infused alfentanil in rats. *Anesth. Analg.* **83**(3), 600–605.
- Klode, A.M., and Aviado, D.M. (1967). Mechanism for the reduction in pulmonary resistance induced by halothane. *J. Pharmacol. Exp. Ther.* **158**(1), 28–35.
- Kobayashi, K. (1985). Strain differences of ether susceptibility in mice. *Jikken. Dobutsu.* **34**(4), 379–386.
- Koblin, D.D., Fang, Z., Eger, E.I., II, Laster, M.J., Gong, D., Ionescu, P., Halsey, M.J., and Trudell, J.R. (1998). Minimum alveolar concentrations of noble gases, nitrogen, and sulfur hexafluoride in rats: Helium and neon as nonimmobilizers (nonanesthetics). *Anesth. Analg.* **87**(2), 419–424.
- Koch, V.W. (2006). Pain and distress: what really matters? *Lab. Anim. (NY)* **35**(5), 27–32.
- Kohler, I., Meier, R., Busato, A., Neiger-Aeschbacher, G., and Schatzmann, U. (1999). Is carbon dioxide (CO₂) a useful short acting anaesthetic for small laboratory animals? *Lab. Anim.* **33**(2), 155–161.
- Kolesnikov, Y. and Pasternak, G.W. (1999). Topical opioids in mice: analgesia and reversal of tolerance by a topical *N*-methyl-D-aspartate antagonist. *J. Pharmacol. Exp. Ther.* **290**(1), 247–252.
- Kolesnikov, Y.A., Chereshev, I., and Pasternak, G.W. (2000). Analgesic synergy between topical lidocaine and topical opioids. *J. Pharmacol. Exp. Ther.* **295**(2), 546–551.
- Kolesnikov, Y.A., Wilson, R.S., and Pasternak, G.W. (2003). The synergistic analgesic interactions between hydrocodone and ibuprofen. *Anesth. Analg.* **97**(6), 1721–1723.
- Komatsu, H., Nogaya, J., Kuratani, N., Ueki, M., Yokono, S., and Ogli, K. (1998). Repetitive post-training exposure to enflurane modifies spatial memory in mice. *Anesthesiology* **89**(5), 1184–1190.
- Komulainen, A., and Olson, M.E. (1991). Antagonism of ketamine–xylazine anesthesia in rats by administration of yohimbine, tolazoline, or 4-aminopyridine. *Am. J. Vet. Res.* **52**(4), 585–588.
- Konat, G.W., Kofke, W.A., and Miric, S. (2003). Toxicity of compound A to C6 rat glioma cells. *Metab. Brain Dis.* **18**(1), 11–15.
- Kong, H., Raynor, K., Yano, H., Takeda, J., Bell, G.I., and Reisine, T. (1994). Agonists and antagonists bind to different domains of the cloned kappa opioid receptor. *Proc. Natl. Acad. Sci. U S A* **91**(17), 8042–8046.
- Koo, S.T., Park, Y.I., Lim, K.S., Chung, K., and Chung, J.M. (2002). Acupuncture analgesia in a new rat model of ankle sprain pain. *Pain* **99**(3), 423–431.
- Kopjas, N.N., Jones, R.T., Bany, B., and Patrylo, P.R. (2006). Reeler mutant mice exhibit seizures during recovery from isoflurane-induced anesthesia. *Epilepsy Res.* **69**(1), 87–91.
- Krugner-Higby, L., Smith, L., Clark, M., Heath, T.D., Dahly, E., Schiffman, B., Hubbard-VanStelle, S., Ney, D., and Wendland, A. (2003). Liposome-encapsulated oxymorphone hydrochloride provides prolonged relief of postsurgical visceral pain in rats. *Comp. Med.* **53**(3), 270–279.
- Kubota, T., Hirota, K., Anzawa, N., Yoshida, H., Kushikata, T., and Matsuki, A. (1999). Physostigmine antagonizes ketamine-induced noradrenaline release from the medial prefrontal cortex in rats. *Brain Res.* **840**(1–2), 175–178.
- Kufoy, E.A., Pakalnis, V.A., Parks, C.D., Wells, A., Yang, C.H., and Fox, A. (1989). Keratoconjunctivitis sicca with associated secondary uveitis elicited in rats after systemic xylazine/ketamine anesthesia. *Exp. Eye Res.* **49**(5), 861–867.
- Kupers, R., and Gybels, J. (1995). The consumption of fentanyl is increased in rats with nociceptive but not with neuropathic pain. *Pain* **60**(2), 137–141.
- Kuratani, N., Komatsu, H., Ogli, K., Nogaya, J., and Tanaka, T. (1996). Multiple but different genetic factors underlie enflurane and isoflurane requirements studied through backcross analysis in C57BL and ddN mice. *Anesth. Analg.* **83**(4), 798–803.
- Laird, J.M., Swindle, M.M., and Flecknell, P.A. (1996). “Handbook of Rodent and Rabbit Medicine.” Pergamon, Tarrytown, NY, USA.
- Laird, J.M., and Cervero, F. (1996). Effects of metamizol on nociceptive responses to stimulation of the ureter and on ureter motility in anaesthetised rats. *Inflamm. Res.* **45**(3), 150–154.
- Laird, J.M., Herrero, J.F., Garcia de la Rubia, P., and Cervero, F. (1997). Analgesic activity of the novel COX-2 preferring NSAID, meloxicam in mono-arthritic rats: Central and peripheral components. *Inflamm. Res.* **46**(6), 203–210.
- Laird, J.M., Roza, C., and Olivar, T. (1998). Antinociceptive activity of metamizol in rats with experimental ureteric calculosis: Central and peripheral components. *Inflamm. Res.* **47**(10), 389–395.
- Langford, D.J., Crager, S.E., Shehzad, Z., Smith, S.B., Sotocinal, S.G., Levenstadt, J.S., Chanda, M.L., Levitin, D.J., and Mogil, J.S. (2006). Social modulation of pain as evidence for empathy in mice. *Science* **312**(5782), 1967–1970.
- Laulin, J.P., Maurette, P., Corcuff, J.B., Rivat, C., Chauvin, M., and Simonnet, G. (2002). The role of ketamine in preventing fentanyl-induced hyperalgesia and subsequent acute morphine tolerance. *Anesth. Analg.* **94**(5), 1263–1269, Table of Contents.
- Lawson, D.M., Duke, J.L., Zammit, T.G., Collins, H.L., and DiCarlo, S.E. (2001). Recovery from carotid artery catheterization performed under various anesthetics in male, Sprague–Dawley rats. *Contemp. Top. Lab. Anim. Sci.* **40**(4), 18–22.
- Leach, M.C., Bowell, V.A., Allan, T.F., and Morton, D.B. (2002a). Aversion to gaseous euthanasia agents in rats and mice. *Comp. Med.* **52**(3), 249–257.
- Leach, M.C., Bowell, V.A., Allan, T.F., and Morton, D.B. (2002b). Degrees of aversion shown by rats and mice to different concentrations of inhalational anaesthetics. *Vet. Rec.* **150**(26), 808–815.
- Leash, A.M., Beyer, R.D., and Wilber, R.G. (1973). Self-mutilation following Innovar-Vet injection in the guinea pig. *Lab. Anim. Sci.* **23**(5), 720–721.
- Lee, S.C., Wang, J.J., Ho, S.T., and Tao, P.L. (1997). Nalbuphine coadministered with morphine prevents tolerance and dependence. *Anesth. Analg.* **84**(4), 810–815.
- Leeuwijn, R.S., van der Wal, J.K., and Spanjer, W. (1984). Interactions of cholinesterase inhibitors and glucocorticoids with ketamine and pentobarbitone-induced general anaesthesia in the rat: Possible effects on central cholinergic activity. *Br. J. Pharmacol.* **82**(2), 339–347.
- Legros, J., Khalili-Varasteh, H., and Margetts, G. (1984). Pharmacological study of pentazocine–naloxone combination: interest as a potentially non-abusable oral form of pentazocine. *Arch. Int. Pharmacodyn. Ther.* **271**(1), 11–21.
- Lemke, K.A., Tranquilli, W.J., Thurmon, J.C., Benson, G.J., and Olson, W.A. (1996). Ability of flumazenil, butorphanol, and naloxone to reverse the anesthetic effects of oxymorphone–diazepam in dogs. *J. Am. Vet. Med. Assoc.* **209**(4), 776–779.
- Lerche, P., Muir, W.W., III, and Bednarski, R.M. (2000). Nonbreathing anesthetic systems in small animal practice. *J. Am. Vet. Med. Assoc.* **217**(4), 493–497.
- Levine, J.D., Gordon, N.C., Taiwo, Y.O., and Coderre, T.J. (1988). Potentiation of pentazocine analgesia by low-dose naloxone. *J. Clin. Invest.* **82**(5), 1574–1577.
- Levine, L.L., Winter, P.M., Nemoto, E.M., Uram, M., and Lin, M.R. (1986). Naloxone does not antagonize the analgesic effects of inhalation anesthetics. *Anesth. Analg.* **65**(4), 330–332.
- Liang, D.Y., Guo, T., Liao, G., Kingery, W.S., Peltz, G., and Clark, J.D. (2006). Chronic pain and genetic background interact and influence opioid analgesia, tolerance, and physical dependence. *Pain* **121**(3), 232–240.
- Lieggi, C.C., Artwohl, J.E., Leszczynski, J.K., Rodriguez, N.A., Fickbohm, B.L., and Fortman, J.D. (2005a). Efficacy and safety of stored and newly prepared tribromoethanol in ICR mice. *Contemp. Top. Lab. Anim. Sci.* **44**(1), 17–22.
- Lieggi, C.C., Fortman, J.D., Kleps, R.A., Sethi, V., Anderson, J.A., Brown, C.E., and Artwohl, J.E. (2005b). An evaluation of preparation methods and storage conditions of tribromoethanol. *Contemp. Top. Lab. Anim. Sci.* **44**(1), 11–16.

- Lightfoote, W.E., II, and Molinari, G.F. (1978). Comparison of ketamine and pentobarbital anesthesia in the Mongolian gerbil. *Am. J. Vet. Res.* **39**(6), 1061–1063.
- Liles, J.H., and Flecknell, P.A. (1994). A comparison of the effects of buprenorphine, carprofen and flunixin following laparotomy in rats. *J. Vet. Pharmacol. Ther.* **17**(4), 284–290.
- Liles, J.H., Flecknell, P.A., Roughan, J., and Cruz-Madorran, I. (1998). Influence of oral buprenorphine, oral naltrexone or morphine on the effects of laparotomy in the rat. *Lab. Anim.* **32**(2), 149–161.
- Lin, M.T., Chen, C.F., and Pang, I.H. (1978). Effect of ketamine on thermoregulation in rats. *Can. J. Physiol. Pharmacol.* **56**(6), 963–967.
- Lind, R.C., Gandolfi, A.J., Brown, B.R., Jr., and Hall, P.M. (1987). Halothane hepatotoxicity in guinea pigs. *Anesth. Analg.* **66**(3), 222–228.
- Lind, R.C., Gandolfi, A.J., and Hall, P.D. (1989). Age and gender influence halothane-associated hepatotoxicity in strain 13 guinea pigs. *Anesthesiology* **71**(6), 878–884.
- Linden, R.D., Shields, C.B., Zhang, Y.P., Edmonds, H.L., and Hunt, M.A. (2000). A laryngoscope designed for intubation of the rat. *Contemp. Top. Lab. Anim. Sci.* **39**(2), 40–42.
- Lindsay, D.S., Kaur, T., Mitchell, S.M., Goodwin, D.G., Strobl, J., and Dubey, J.P. (2005). Buprenorphine does not affect acute murine toxoplasmosis and is recommended as an analgesic in *Toxoplasma gondii* studies in mice. *J. Parasitol.* **91**(6), 1488–1490.
- Lipman, N.S., Phillips, P.A., and Newcomer, C.E. (1987). Reversal of ketamine/xylazine anesthesia in the rabbit with yohimbine. *Lab. Anim. Sci.* **37**(4), 474–477.
- Liu, K.S., Hu, O.Y., Ho, S.T., Tzeng, J.I., Chen, Y.W., and Wang, J.J. (2004). Antinociceptive effect of a novel long-acting nalbuphine preparation. *Br. J. Anaesth.* **92**(5), 712–715.
- Loepke, A.W., McCann, J.C., Kurth, C.D., and McAuliffe, J.J. (2006). The physiologic effects of isoflurane anesthesia in neonatal mice. *Anesth. Analg.* **102**(1), 75–80.
- Loomis, C.W., Penning, J., and Milne, B. (1989). A study of the analgesic interaction between intrathecal morphine and subcutaneous nalbuphine in the rat. *Anesthesiology* **71**(5), 704–710.
- Lopez, J.R., Dominguez-Ramirez, A.M., Cook, H.J., Bravo, G., Diaz-Reval, M.I., Deciga-Campos, M., and Lopez-Munoz, F.J. (2006). Enhancement of antinociception by co-administration of ibuprofen and caffeine in arthritic rats. *Eur. J. Pharmacol.* **544**(1–3), 31–38.
- Lorenz, J.N. (2002). A practical guide to evaluating cardiovascular, renal, and pulmonary function in mice. *Am. J. Physiol. Regul. Integr. Comp. Physiol.* **282**(6), R1565–R1582.
- Luciano, L., and Reale, E. (1992). The “limiting ridge” of the rat stomach. *Arch. Histol. Cytol.* **55**(Suppl.), 131–138.
- Lumb, W.V., and Jones, E.W. (1984). Preanesthetic agents. In “Lumb & Jones’ Veterinary Anesthesia.” 2nd ed. Lea & Febiger.
- Lunam, C.A., Cousins, M.J., and Hall, P.D. (1985). Guinea-pig model of halothane-associated hepatotoxicity in the absence of enzyme induction and hypoxia. *J. Pharmacol. Exp. Ther.* **232**(3), 802–809.
- Lutz, M., and Liu, H. (2006). Inhaled sevoflurane produces better delayed myocardial protection at 48 versus 24 hours after exposure. *Anesth. Analg.* **102**(4), 984–990.
- MacDonald, E., Haapalinna, A., Virtanen, R., and Lammintausta, R. (1989). Effects of acute administration of medetomidine on the behaviour, temperature and turnover rates of brain biogenic amines in rodents and reversal of these effects by atipamezole. *Acta Vet. Scand. Suppl.* **85**, 77–81.
- Mahel’ova, O., and Linkova, A. (1991). Effect of indomethacin on selected immune parameters in different age groups of mice. *Physiol. Res.* **40**(3), 355–358.
- Malik, A.A., Radhakrishnan, N., Reddy, K., Smith, A.D., and Singhal, P.C. (2002). Morphine-induced macrophage apoptosis modulates migration of macrophages: Use of in vitro model of urinary tract infection. *J. Endourol.* **16**(8), 605–610.
- Mariani, L., and Bonanomi, L. (1978). Resistance of the guinea pig to indomethacin ulcerogenesis. *Toxicol. Appl. Pharmacol.* **45**(2), 637–639.
- Martin, L.B., Thompson, A.C., Martin, T., and Kristal, M.B. (2001). Analgesic efficacy of orally administered buprenorphine in rats. *Comp. Med.* **51**(1), 43–48.
- Martucci, C., Panerai, A.E., and Sacerdote, P. (2004). Chronic fentanyl or buprenorphine infusion in the mouse: Similar analgesic profile but different effects on immune responses. *Pain* **110**(1–2), 385–392.
- Matson, D.J., Broom, D.C., Carson, S.R., Baldassari, J., Kehne, J., and Cortright, D.N. (2007). Inflammation-induced reduction of spontaneous activity by adjuvant: A novel model to study the effect of analgesics in rats. *J. Pharmacol. Exp. Ther.* **320**(1), 194–201.
- Matsuura, S., Shirakami, G., Iida, H., Tanimoto, K., and Fukuda, K. (2006). The effect of sevoflurane on ciliary motility in rat cultured tracheal epithelial cells; a comparison with isoflurane and halothane. *Anesth. Analg.* **102**(6), 1703–1708.
- Matthes, H.W., Maldonado, R., Simonin, F., Valverde, O., Slowe, S., Kitchen, I., Befort, K., Dierich, A., Le Meur, M., Dolle, P. et al. (1996). Loss of morphine-induced analgesia, reward effect and withdrawal symptoms in mice lacking the mu-opioid-receptor gene. *Nature* **383**(6603), 819–823.
- McLaughlin, C.R., and Dewey, W.L. (1994). A comparison of the antinociceptive effects of opioid agonists in neonatal and adult rats in phasic and tonic nociceptive tests. *Pharmacol. Biochem. Behav.* **49**(4), 1017–1023.
- McLaughlin, J.P., Li, S., Valdez, J., Chavkin, T.A., and Chavkin, C. (2006). Social defeat stress-induced behavioral responses are mediated by the endogenous kappa opioid system. *Neuropsychopharmacology* **31**(6), 1241–1248.
- Medhurst, S.J., Walker, K., Bowes, M., Kidd, B.L., Glatt, M., Muller, M., Hattemberger, M., Vaxelaire, J., O’Reilly, T., Wotherspoon, G. et al. (2002). A rat model of bone cancer pain. *Pain* **96**(1–2), 129–140.
- Meert, T.F., and De Kock, M. (1994). Potentiation of the analgesic properties of fentanyl-like opioids with alpha 2-adrenoceptor agonists in rats. *Anesthesiology* **81**(3), 677–688.
- Meert, T.F., and Vermeirsch, H.A. (2005). A preclinical comparison between different opioids: Antinociceptive versus adverse effects. *Pharmacol. Biochem. Behav.* **80**(2), 309–326.
- Melamed, R., Bar-Yosef, S., Shakhar, G., Shakhar, K., and Ben-Eliyahu, S. (2003). Suppression of natural killer cell activity and promotion of tumor metastasis by ketamine, thiopental, and halothane, but not propofol: Mediating mechanisms and prophylactic measures. *Anesth. Analg.* **97**(5), 1331–1339.
- Mellon, R.D., and Bayer, B.M. (2001). Reversal of acute effects of high dose morphine on lymphocyte activity by chlorisondamine. *Drug Alcohol Depend.* **62**(2), 141–147.
- Mertens, J., and Muller-Deile, J. (1991). The value of fentanyl/diazepam anesthesia for experimental operations and recordings of compound action potentials in the guinea pig cochlea. *Eur. Arch. Otorhinolaryngol.* **248**(7), 402–405.
- Messiha, F.S. (1991). Neurotoxicity of chlorpromazine and modulation by amantadine as a function of mouse strain. *Neurotoxicology* **12**(3), 571–581.
- Mets, B., Janicki, P.K., James, M.F., and Hickman, R. (1997). Hepatic energy charge and adenine nucleotide status in rats anesthetized with halothane, isoflurane or enflurane. *Acta Anaesthesiol. Scand.* **41**(2), 252–255.
- Metten, P., Buck, K.J., Merrill, C.M., Roberts, A.J., Yu, C.H., and Crabbe, J.C. (2007). Use of a novel mouse genotype to model acute benzodiazepine withdrawal. *Behav. Genet.* **37**(1), 160–170.
- Meyer, R.E., and Fish, R.E. (2005). A review of tribromoethanol anesthesia for production of genetically engineered mice and rats. *Lab. Anim. (NY)* **34**(10), 47–52.
- Mickley, G.A., Hoxha, Z., Biada, J.M., Kenmuir, C.L., and Bacik, S.E. (2006). Acetaminophen self-administered in the drinking water increases the pain threshold of rats (*Rattus norvegicus*). *J. Am. Assoc. Lab. Anim. Sci.* **45**(5), 48–54.

- Milanes, M.V., Cremades, A., and del Rio, J. (1984). Possible mechanisms implicated on the hypothermic effect induced by morphine in guinea-pig. *Gen. Pharmacol.* **15**(4), 357–360.
- Millicamps, M., Jourdan, D., Leger, S., Etienne, M., Eschaliere, A., and Ardid, D. (2005). Circadian pattern of spontaneous behavior in monoarthritic rats: A novel global approach to evaluation of chronic pain and treatment effectiveness. *Arthritis Rheum.* **52**(11), 3470–3478.
- Mimura, M., Namiki, A., Kishi, R., Ikeda, T., and Miyake, H. (1990). Antagonistic effect of physostigmine on ketamine-induced anesthesia. *Psychopharmacology (Berl.)* **102**(3), 399–403.
- Mimura, M., Namiki, A., Kishi, R., Ikeda, T., Miyake, H., and Iwasaki, H. (1992). Central cholinergic action produces antagonism to ketamine anesthesia. *Acta Anaesthesiol. Scand.* **36**(5), 460–462.
- Mishra, Y., and Ramzan, I. (1992a). Influence of cimetidine on gallamine-induced neuromuscular paralysis in rats. *Clin. Exp. Pharmacol. Physiol.* **19**(12), 803–807.
- Mishra, Y., and Ramzan, I. (1992b). Interaction between succinylcholine and cimetidine in rats. *Can. J. Anaesth.* **39**(4), 370–374.
- Mishra, Y., and Ramzan, I. (1993a). Interaction between famotidine and neuromuscular blockers: an in vivo study in rats. *Anesth. Analg.* **77**(4), 780–783.
- Mishra, Y., and Ramzan, I. (1993b). Ranitidine reverses gallamine paralysis in rats. *Anesth. Analg.* **76**(3), 627–630.
- Mishra, Y., and Ramzan, I. (1993c). Interaction between succinylcholine and ranitidine in rats. *Can. J. Anaesth.* **40**(1), 32–37.
- Molina, V.A., Heyser, C.J., and Spear, L.P. (1994). Chronic variable stress or chronic morphine facilitates immobility in a forced swim test: Reversal by naloxone. *Psychopharmacology (Berl.)* **114**(3), 433–440.
- Molthen, R.C. (2006). A simple, inexpensive, and effective light-carrying laryngoscopic blade for orotracheal intubation of rats. *J. Am. Assoc. Lab. Anim. Sci.* **45**(1), 88–93.
- Morch, E.T., Aycrigg, J.B., and Berger, M.S. (1956). The anesthetic effects of ethyl vinyl ether, divinyl ether, and diethyl ether on mice. *J. Pharmacol. Exp. Ther.* **117**(2), 184–189.
- Morimoto, K., Nishimura, R., Matsunaga, S., Mochizuki, M., and Sasaki, N. (2001). Epidural analgesia with a combination of bupivacaine and buprenorphine in rats. *J. Vet. Med. A Physiol. Pathol. Clin. Med.* **48**(5), 303–312.
- Muir, W.W., and Hubbell, J.A.E. (1989). "Handbook of Veterinary Anesthesia." The C.V. Mosby Company, St. Louis, MO.
- Mulder, J.B. (1978). Anesthesia in the mouse using a combination of ketamine and promazine. *Lab. Anim. Sci.* **28**(1), 70–71.
- Mulder, J.B., and Johnson, H.B., Jr. (1978). Ketamine and promazine for anesthesia in the rat. *J. Am. Vet. Med. Assoc.* **173**(9), 1252–1253.
- Mulder, K.J., and Mulder, J.B. (1979). Ketamine and xylazine anesthesia in the mouse. *Vet. Med. Small Anim. Clin.* **74**(4), 569–570.
- Nadeson, R., and Goodchild, C.S. (2000). Antinociceptive properties of neurosteroids II. Experiments with Saffan and its components alphaxalone and alphadolone to reveal separation of anaesthetic and antinociceptive effects and the involvement of spinal cord GABA(A) receptors. *Pain* **88**(1), 31–39.
- National Institute for Occupational Safety and Health (1977). Criteria for a recommended standard: Occupational exposure to waste anesthesia gases and vapors. Public Health Service, U.S. Government Printing Office, Washington, D.C.
- Nelson, C.J., Dykstra, L.A., and Lysle, D.T. (1997). Comparison of the time course of morphine's analgesic and immunologic effects. *Anesth. Analg.* **85**(3), 620–626.
- Nemeth, S., Viskupic, E., and Murgas, K. (1985). Intravenous thiobarbital anaesthesia for determination of liver glycogen phosphorylase activity in rats subjected to various forms of stress. *Endocrinol. Exp.* **19**(2), 91–95.
- Neugebauer, V., Schaible, H.G., He, X., Lucke, T., Gundling, P., and Schmidt, R.F. (1994). Electrophysiological evidence for a spinal antinociceptive action of dipyrone. *Agents Actions* **41**(1–2), 62–70.
- Nevalainen, T., Pyhala, L., Voipio, H.M., and Virtanen, R. (1989). Evaluation of anaesthetic potency of medetomidine–ketamine combination in rats, guinea-pigs and rabbits. *Acta Vet. Scand. Suppl.* **85**, 139–143.
- Newton, W.M., Cusick, P.K., and Raffae, M.R. (1975). Innovar-Vet-induced pathologic changes in the guinea pig. *Lab. Anim. Sci.* **25**(5), 597–601.
- Nielsen, A.N., Mathiesen, C., and Blackburn-Munro, G. (2004). Pharmacological characterisation of acid-induced muscle allodynia in rats. *Eur. J. Pharmacol.* **487**(1–3), 93–103.
- Nielsen, G.D., Olsen, J., Bakbo, J.C., and Holst, E. (1985). Propyl ether. II. Pulmonary irritation and anaesthesia. *Acta Pharmacol. Toxicol. (Copenh.)* **56**(2), 165–175.
- Nikfar, S., Abdollahi, M., Etemad, F., and Sharifzadeh, M. (1997). Effects of sweetening agents on morphine-induced analgesia in mice by formalin test. *Gen. Pharmacol.* **29**(4), 583–586.
- Nishiyama, T. (2006). Analgesic effects of intrathecally administered celecoxib, a cyclooxygenase-2 inhibitor, in the tail flick test and the formalin test in rats. *Acta Anaesthesiol. Scand.* **50**(2), 228–233.
- Njoku, D., Laster, M.J., Gong, D.H., Eger, E.I., II, Reed, G.F., and Martin, J.L. (1997). Biotransformation of halothane, enflurane, isoflurane, and desflurane to trifluoroacetylated liver proteins: Association between protein acylation and hepatic injury. *Anesth. Analg.* **84**(1), 173–178.
- Noguchi, M., Kimoto, A., Kobayashi, S., Yoshino, T., Miyata, K., and Sasamata, M. (2005). Effect of celecoxib, a cyclooxygenase-2 inhibitor, on the pathophysiology of adjuvant arthritis in rat. *Eur. J. Pharmacol.* **513**(3), 229–235.
- Norris, M.L., and Turner, W.D. (1983). An evaluation of tribromoethanol (TBE) as an anaesthetic agent in the Mongolian gerbil (*Meriones unguiculatus*). *Lab. Anim.* **17**(4), 324–329.
- Noseworthy, M.D., Janzen, E.G., Towner, R.A., and Yamashiro, S. (1997). In vivo study of halothane hepatotoxicity in the rat using magnetic resonance imaging and ³¹P spectroscopy. *J. Biochem. Biophys. Methods* **34**(2), 107–122.
- Notarnicola, A., Landi, M., Bianchi, G., and Tavani, A. (1983). Relative ability of *N*-methyl nalorphine and *N*-methyl levallorphan to prevent antinociception and intestinal transit inhibition in morphine treated rats. *Life Sci.* **33**(Suppl. 1), 481–484.
- Obal, D., Preckel, B., Scharbatke, H., Mullenheim, J., Hoterkes, F., Thamer, V., and Schlack, W. (2001). One MAC of sevoflurane provides protection against reperfusion injury in the rat heart in vivo. *Br. J. Anaesth.* **87**(6), 905–911.
- Obal, D., Scharbatke, H., Barthel, H., Preckel, B., Mullenheim, J., and Schlack, W. (2003). Cardioprotection against reperfusion injury is maximal with only two minutes of sevoflurane administration in rats. *Can. J. Anaesth.* **50**(9), 940–945.
- Office of Laboratory Animal Welfare (2002). Public Health Service Policy on Human Care and Use of Laboratory Animals. Department of Health and Human Services, National Institutes of Health.
- Ogawa, A., Morimoto, T., Hu, J.W., Tsuboi, Y., Tashiro, A., Noguchi, K., Nakagawa, H., and Iwata, K. (2003). Hard-food mastication suppresses complete Freund's adjuvant-induced nociception. *Neuroscience* **120**(4), 1081–1092.
- Olson, M.E., and McCabe, K. (1986). Anesthesia in the Richardson's ground squirrel: Comparison of ketamine, ketamine and xylazine, droperidol and fentanyl, and sodium pentobarbital. *J. Am. Vet. Med. Assoc.* **189**(9), 1035–1037.
- Olson, M.E., and Renchko, P. (1988). Azaperone and azaperone-ketamine as a neuroleptic sedative and anesthetic in rats and mice. *Lab. Anim. Sci.* **38**(3), 299–304.
- Omisore, N.O., Adewunmi, C.O., Iwalewa, E.O., Ngadjui, B.T., Watchueng, J., Abegaz, B.M., and Ojewole, J.A. (2004). Antinociceptive and anti-inflammatory effects of *Dorstenia barteri* (Moraceae) leaf and twig extracts in mice. *J. Ethnopharmacol.* **95**(1), 7–12.
- Ordodi, V.L., Mic, F.A., Mic, A.A., Sandesc, D., and Paunescu, V. (2005). A simple device for intubation of rats. *Lab. Anim. (NY)* **34**(8), 37–39.
- Oropeza-Hernandez, L.F., Quintanilla-Vega, B., Albores, A., and Fernandez-Guasti, A. (2002). Inhibitory action of halothane on rat masculine sexual behavior and sperm motility. *Pharmacol. Biochem. Behav.* **72**(4), 937–942.

- Ortiz, M.I., Torres-Lopez, J.E., Castaneda-Hernandez, G., Rosas, R., Vidal-Cantu, G.C., and Granados-Soto, V. (2002). Pharmacological evidence for the activation of K(+) channels by diclofenac. *Eur. J. Pharmacol.* **438**(1–2), 85–91.
- Ostrowski, N.L., Stapleton, J.M., Noble, R.G., and Reid, L.D. (1979). Morphine and naloxone's effects on sexual behavior of the female golden hamster. *Pharmacol. Biochem. Behav.* **11**(6), 673–681.
- Ozdogan, U.K., Lahdesmaki, J., Hakala, K., and Scheinin, M. (2004). The involvement of alpha 2A-adrenoceptors in morphine analgesia, tolerance and withdrawal in mice. *Eur. J. Pharmacol.* **497**(2), 161–171.
- Ozdogan, U.K., Lahdesmaki, J., and Scheinin, M. (2006). The analgesic efficacy of partial opioid agonists is increased in mice with targeted inactivation of the alpha2A-adrenoceptor gene. *Eur. J. Pharmacol.* **529**(1–3), 105–113.
- Paddleford, R.R. (1986). Exposure of veterinary personnel to waste anesthetic: is there cause for concern? *Semin. Vet. Med. Surg. (Small Anim.)* **1**, 249–255.
- Padi, S.S., Jain, N.K., Singh, S., and Kulkarni, S.K. (2004). Pharmacological profile of parecoxib: a novel, potent injectable selective cyclooxygenase-2 inhibitor. *Eur. J. Pharmacol.* **491**(1), 69–76.
- Page, G.G., and Ben-Eliyahu, S. (2002). Indomethacin attenuates the immunosuppressive and tumor-promoting effects of surgery. *J. Pain* **3**(4), 301–308.
- Page, G.G., Blakely, W.P., and Ben-Eliyahu, S. (2001). Evidence that postoperative pain is a mediator of the tumor-promoting effects of surgery in rats. *Pain* **90**(1–2), 191–199.
- Papaoiannou, V.E., and Fox, J.G. (1993). Efficacy of tribromoethanol anesthesia in mice. *Lab. Anim. Sci.* **43**(2), 189–192.
- Pape, M., Engelhard, K., Eberspacher, E., Hollweck, R., Kellerman, K., Zinter, S., Hutzler, P., and Werner, C. (2006). The long term effect of sevoflurane on neuronal cell damage and expression of apoptotic factors after cerebral ischemia and reperfusion in rats. *Anesth. Analg.* **103**(1), 173–179.
- Paris, A., Ohlendorf, C., Marquardt, M., Bein, B., Sonner, J.M., Scholz, J., and Tonner, P.H. (2005). The effect of meperidine on thermoregulation in mice: Involvement of alpha2-adrenoceptors. *Anesth. Analg.* **100**(1), 102–106.
- Park, K.W., Dai, H.B., Lowenstein, E., and Sellke, F.W. (1998). Epithelial dependence of the bronchodilatory effect of sevoflurane and desflurane in rat distal bronchi. *Anesth. Analg.* **86**(3), 646–651.
- Park, W.K., Pancrazio, J.J., Suh, C.K., and Lunch, C. (1996). Myocardial depressant effects of sevoflurane. Mechanical and electrophysiologic actions in vivo. *Anesthesiology* **84**(5), 1166–1176.
- Parkhill, A.L., and Bidlack, J.M. (2006). Reduction of lipopolysaccharide-induced interleukin-6 production by the kappa opioid U50,488 in a mouse monocyte-like cell line. *Int. Immunopharmacol.* **6**(6), 1013–1019.
- Pavone, F., Consorti, D., and Fagioli, S. (1989). Developmental differences of antinociceptive effects of oxotremorine in two inbred strains of mice. *Brain Res. Dev. Brain Res.* **49**(1), 156–160.
- Payne, R.S., Akca, O., Roewer, N., Schurr, A., and Kehl, F. (2005). Sevoflurane-induced preconditioning protects against cerebral ischemic neuronal damage in rats. *Brain Res.* **1034**(1–2), 147–152.
- Payton, A.J., Forsythe, D.B., Dixon, D., Myers, P.H., Clark, J.A., and Snipe, J.R. (1993). Evaluation of ketamine-xylazine in Syrian hamsters. *Cornell Vet.* **83**(2), 153–161.
- Penderis, J., and Franklin, R.J. (2005). Effects of pre- versus post-anaesthetic buprenorphine on propofol-anaesthetized rats. *Vet. Anaesth. Analg.* **32**(5), 256–260.
- Perez-Garcia, C.C., Pena-Penabad, M., Cano-Rabano, M.J., Garcia-Rodriguez, M.B., Gallego-Morales, D., Rios-Granja, M.A., and Diez-Prieto, I. (2003). A simple procedure to perform intravenous injections in the Mongolian gerbil (*Meriones unguiculatus*). *Lab. Anim.* **37**(1), 68–71.
- Petzelt, C., Blom, P., Schmehl, W., Muller, J., and Kox, W.J. (2003). Prevention of neurotoxicity in hypoxic cortical neurons by the noble gas xenon. *Life Sci.* **71**(17), 1909–1918.
- Phifer, C.B., and Terry, L.M. (1986). Use of hypothermia for general anesthesia in preweaning rodents. *Physiol. Behav.* **38**(6), 887–890.
- PHS. (2002). Policy on Humane Care and Use of Laboratory Animals. from [//grants.nih.gov/grants/olaw/references/phspol.htm](http://grants.nih.gov/grants/olaw/references/phspol.htm).
- Pick, C.G. (1996). Strain differences in mice antinociception: Relationship between alprazolam and opioid receptor subtypes. *Eur. Neuropsychopharmacol.* **6**(3), 201–205.
- Pick, C.G., Cheng, J., Paul, D., and Pasternak, G.W. (1991). Genetic influences in opioid analgesic sensitivity in mice. *Brain Res.* **566**(1–2), 295–298.
- Piersma, F.E., Daemen, M.A., Bogaard, A.E., and Buurman, W.A. (1999). Interference of pain control employing opioids in vivo immunological experiments. *Lab. Anim.* **33**(4), 328–333.
- Pinardi, G., Prieto, J.C., and Miranda, H.F. (2005). Analgesic synergism between intrathecal morphine and cyclooxygenase-2 inhibitors in mice. *Pharmacol. Biochem. Behav.* **82**(1), 120–124.
- Plachinta, R.V., Hayes, J.K., Cerilli, L.A., and Rich, G.F. (2003). Isoflurane pretreatment inhibits lipopolysaccharide-induced inflammation in rats. *Anesthesiology* **98**(1), 89–95.
- Planas, E., Poveda, R., Sanchez, S., Romero, A., and Puig, M.M. (2003). Non-steroidal anti-inflammatory drugs antagonise the constipating effects of tramadol. *Eur. J. Pharmacol.* **482**(1–3), 223–226.
- Plate, A.Y., Crankshaw, D.L., and Gallaher, D.D. (2005). The effect of anesthesia by diethyl ether or isoflurane on activity of cytochrome P450 2E1 and P450 reductases in rat liver. *Anesth. Analg.* **101**(4), 1063–1064.
- Pomonis, J.D., Boulet, J.M., Gottshall, S.L., Phillips, S., Sellers, R., Bunton, T., and Walker, K. (2005). Development and pharmacological characterization of a rat model of osteoarthritis pain. *Pain* **114**(3), 339–346.
- Poole, T.B. (1987). "The UFVA Handbook on the Care and Management of Laboratory Animals." Longman Scientific and Technical, Essex, UK.
- Poonawala, T., Levay-Young, B.K., Hebbel, R.P., and Gupta, K. (2005). Opioids heal ischemic wounds in the rat. *Wound Repair Regen.* **13**(2), 165–174.
- Poveda, R., Planas, E., Pol, O., Romero, A., Sanchez, S., and Puig, M.M. (2003). Interaction between metamizol and tramadol in a model of acute visceral pain in rats. *Eur. J. Pain* **7**(5), 439–448.
- Poyhia, R., Xu, M., Kontinen, V.K., Paananen, S., and Kalso, E. (1999). Systemic physostigmine shows antiallodynic effects in neuropathic rats. *Anesth. Analg.* **89**(2), 428–433.
- Prado, W.A., and Pontes, R.M. (2002). Presurgical ketoprofen, but not morphine, dipyron, diclofenac or tenoxicam, preempts post-incisional mechanical allodynia in rats. *Braz. J. Med. Biol. Res.* **35**(1), 111–119.
- Prechel, M.M., Ding, C., Washington, R.L., Kolodziej, M.S., and Young, M.R. (2000). In vivo indomethacin treatment causes microglial activation in adult mice. *Neurochem. Res.* **25**(3), 357–362.
- Puig, N.R., Amerio, N., Piaggio, E., Barragan, J., Comba, J.O., and Elena, G.A. (1999). Effects of halothane reexposure in female mice and their offspring. *Reprod. Toxicol.* **13**(5), 361–367.
- Radde, G.R., Hinson, A., Crenshaw, D., and Toth, L.A. (1996). Evaluation of anaesthetic regimens in guinea pigs. *Lab. Anim.* **30**(3), 220–227.
- Rampil, I.J., and King, B.S. (1996). Volatile anesthetics depress spinal motor neurons. *Anesthesiology* **85**(1), 129–134.
- Rampil, I.J., Moller, D.H., and Bell, A.H. (2006). Isoflurane modulates genomic expression in rat amygdala. *Anesth. Analg.* **102**(5), 1431–1438.
- Rana, J., and Ramzan, I. (1995). Neuromuscular blocking drug pharmacodynamics after chronic exposure to H2-antagonists. *In Vivo* **9**(2), 163–166.
- Randolph, B.C., and Peters, M.A. (1997). Analgesic effectiveness of ketorolac compared to meperidine in the rat formalin test. *Anesth. Prog.* **44**(1), 11–16.
- Rank, J., and Jensen, A.G. (1989). The value of anaesthetic steroids alphaxalone–alphadolone in pregnant mice. *Scand. J. Lab. Anim. Sci.* **16**(3), 115–117.
- Rao, S.B. (1990). Comparative study on the effects of pentobarbitone sodium, thiopentone sodium and ketamine–diazepam on body temperature in rats. *Indian Vet. J.* **67**, 339–342.
- Reboucas, E.C., Segato, E.N., Kishi, R., Freitas, R.L., Savoldi, M., Morato, S., and Coimbra, N.C. (2005). Effect of the blockade of mu1-opioid and

- 5HT_{2A}-serotonergic/alpha₁-noradrenergic receptors on sweet-substance-induced analgesia. *Psychopharmacology (Berl.)* **179**(2), 349–355.
- Redwine, K.E., and Trujillo, K.A. (2003). Effects of NMDA receptor antagonists on acute mu-opioid analgesia in the rat. *Pharmacol. Biochem. Behav.* **76**(2), 361–372.
- Reid, W.D., Davies, C., Pare, P.D., and Pardy, R.L. (1989). An effective combination of anaesthetics for 6-h experimentation in the golden Syrian hamster. *Lab. Anim.* **23**(2), 156–162.
- Rembert, M.S., Smith, J.A., and Hosgood, G. (2004). A comparison of a forced-air warming system to traditional thermal support for rodent microenvironments. *Lab. Anim.* **38**(1), 55–63.
- Rhodes, J., Mickleborough, T.D., Owiny, J., and Tucker, A. (2001). Anesthesia protocol for hyperpnea-induced airway obstruction in the guinea pig. *Comp. Med.* **51**(5), 457–461.
- Richardson, C.A., and Flecknell, P.A. (2005). Anaesthesia and post-operative analgesia following experimental surgery in laboratory rodents: Are we making progress? *Altern. Lab. Anim.* **33**(2), 119–127.
- Richebe, P., Rivat, C., Laulin, J.P., Maurette, P., and Simonnet, G. (2005). Ketamine improves the management of exaggerated postoperative pain observed in perioperative fentanyl-treated rats. *Anesthesiology* **102**(2), 421–428.
- Rieg, T., Richter, K., Osswald, H., and Vallon, V. (2004). Kidney function in mice: thiobutobarbital versus alpha-chloralose anesthesia. *Naunyn Schmiedeberg's Arch. Pharmacol.* **370**(4), 320–323.
- Robertson, S.A. (2001). Analgesia and analgesic techniques. *Vet. Clin. North Am. Exot. Anim. Pract.* **4**(1), 1–18.
- Rodrigues, S.F., de Oliveira, M.A., Martins, J.O., Sannomiya, P., de Cassia Tostes, R., Nigro, D., Carvalho, M.H., and Fortes, Z.B. (2006). Differential effects of chloral hydrate- and ketamine/xylazine-induced anesthesia by the s.c. route. *Life Sci.* **79**(17), 1630–1637.
- Rofael, H.Z., Turkall, R.M., and Abdel-Rahman, M.S. (2003). Immunomodulation by cocaine and ketamine in postnatal rats. *Toxicology* **188**(1), 101–114.
- Rogers, B. (1986). Exposure to waste anesthetic gases: A review of toxic effects. *AAOHN J.* **34**, 574–579.
- Roughan, J.V., and Flecknell, P.A. (2001). Behavioural effects of laparotomy and analgesic effects of ketoprofen and carprofen in rats. *Pain* **90**(1–2), 65–74.
- Roughan, J.V., and Flecknell, P.A. (2002). Buprenorphine: A reappraisal of its antinociceptive effects and therapeutic use in alleviating post-operative pain in animals. *Lab. Anim.* **36**(3), 322–343.
- Roughan, J.V., and Flecknell, P.A. (2003). Evaluation of a short duration behaviour-based post-operative pain scoring system in rats. *Eur. J. Pain* **7**(5), 397–406.
- Roughan, J.V., and Flecknell, P.A. (2004). Behaviour-based assessment of the duration of laparotomy-induced abdominal pain and the analgesic effects of carprofen and buprenorphine in rats. *Behav. Pharmacol.* **15**(7), 461–472.
- Roughan, J.V., Ojeda, O.B., and Flecknell, P.A. (1999). The influence of pre-anaesthetic administration of buprenorphine on the anaesthetic effects of ketamine/medetomidine and pentobarbitone in rats and the consequences of repeated anaesthesia. *Lab. Anim.* **33**(3), 234–242.
- Roy, S., Guo, X., Kelschenbach, J., Liu, Y., and Loh, H.H. (2005). In vivo activation of a mutant mu-opioid receptor by naltrexone produces a potent analgesic effect but no tolerance: Role of mu-receptor activation and delta-receptor blockade in morphine tolerance. *J. Neurosci.* **25**(12), 3229–3233.
- Russell, G.B., and Graybeal, J.M. (1995). Differences in anesthetic potency between Sprague–Dawley and Long–Evans rats for isoflurane but not nitrous oxide. *Pharmacology* **50**(3), 162–167.
- Russell, W.M.S., and Burch, R.L. (1959). “The Principles of Humane Experimental Techniques.” Methuen & Co, London, UK.
- Sabetkasaie, M., Vala, S., Khansefid, N., Hosseini, A.R., and Sadat Ladgevardi, M.A. (2004). Clonidine and guanfacine-induced antinociception in visceral pain: Possible role of alpha_{2/12} binding sites. *Eur. J. Pharmacol.* **501**(1–3), 95–101.
- Sacerdote, P. (2006). Opioids and the immune system. *Palliat. Med.* **20**(Suppl. 1), s9–s15.
- Sage, M.D., West, E.J., and Gavin, J.B. (1985). Cardiac performance of isolated beating hearts obtained from rats anesthetized by three different agents. *Lab. Anim. Sci.* **35**(2), 153–155.
- Saito, O., Aoe, T., and Yamamoto, T. (2005). Analgesic effects of nonsteroidal antiinflammatory drugs, acetaminophen, and morphine in a mouse model of bone cancer pain. *J. Anesth.* **19**(3), 218–224.
- Santos, A.R., Vedana, E.M., and De Freitas, G.A. (1998). Antinociceptive effect of meloxicam, in neurogenic and inflammatory nociceptive models in mice. *Inflamm. Res.* **47**(7), 302–307.
- Sarlis, N.J., and Kaniaris, P.K. (1991). Physostigmine is equipotent to flumazenil only in excessive doses, while naloxone is ineffective in reversing midazolam anesthesia. *Middle East J. Anesthesiol.* **11**(3), 271–288.
- Sarraf-Yazdi, S., Sheng, H., Brinkhous, A.D., Pearlstein, R.D., and Warner, D.S. (1999). Effects of postischemic halothane administration on outcome from transient focal cerebral ischemia in the rat. *J. Neurosurg. Anesthesiol.* **11**(1), 31–36.
- Saurer, T.B., Carrigan, K.A., Ijames, S.G., and Lysle, D.T. (2006). Suppression of natural killer cell activity by morphine is mediated by the nucleus accumbens shell. *J. Neuroimmunol.* **173**(1–2), 3–11.
- Schaefer, C.F., Brackett, D.J., Downs, P., Tompkins, P., and Wilson, M.F. (1984). Laryngoscopic endotracheal intubation of rats for inhalation anesthesia. *J. Appl. Physiol.* **56**(2), 533–535.
- Schmidt, W.K., Tam, S.W., Sholtzberger, G.S., Smith, D.H., Jr., Clark, R., and Vernier, V.G. (1985). Nalbuphine. *Drug Alcohol Depend.* **14**(3–4), 339–362.
- Scholer, D.W., Ku, E.C., Boettcher, I., and Schweizer, A. (1986). Pharmacology of diclofenac sodium. *Am. J. Med.* **80**(4B), 34–38.
- Schultz, V.L., Boass, A., Garner, S.C., and Toverud, S.U. (1995). Several anesthetics, but not diethyl ether, cause marked elevation of serum parathyroid hormone concentration in rats. *J. Bone Miner. Res.* **10**(9), 1298–1302.
- Schwenke, D.O., and Cragg, P.A. (2004). Comparison of the depressive effects of four anesthetic regimens on ventilatory and cardiovascular variables in the guinea pig. *Comp. Med.* **54**(1), 77–85.
- Segato, F.N., Castro-Souza, C., Segato, E.N., Morato, S., and Coimbra, N.C. (1997). Sucrose ingestion causes opioid analgesia. *Braz. J. Med. Biol. Res.* **30**(8), 981–984.
- Sendil, D., Bonney, I.M., Carr, D.B., Lipkowski, A.W., Wise, D.L., and Hasirci, V. (2003). Antinociceptive effects of hydromorphone, bupivacaine and biphalin released from PLGA polymer after intrathecal implantation in rats. *Biomaterials* **24**(11), 1969–1976.
- Serita, R., Morisaki, H., Ai, K., Morita, Y., Innami, Y., Satoh, T., Kosugi, S., Kotake, Y., and Takeda, J. (2002). Sevoflurane preconditions stunned myocardium in septic but not healthy isolated rat hearts. *Br. J. Anaesth.* **89**(6), 896–903.
- Severs, W.B., Keil, L.C., Klase, P.A., and Deen, K.C. (1981). Urethane anesthesia in rats. Altered ability to regulate hydration. *Pharmacology* **22**(4), 209–226.
- Sharma, S., Jain, N.K., and Kulkarni, S.K. (2005). Possible analgesic and anti-inflammatory interactions of aspartame with opioids and NSAIDs. *Indian J. Exp. Biol.* **43**(6), 498–502.
- Sharp, J., Zammit, T., Azar, T., and Lawson, D. (2003). Recovery of male rats from major abdominal surgery after treatment with various analgesics. *Contemp. Top. Lab. Anim. Sci.* **42**(6), 22–27.
- Sheffels, P., Schroeder, J.L., Altuntas, T.G., Liggitt, H.D., and Kharasch, E.D. (2004). Role of cytochrome P4503A in cysteine S-conjugates sulfoxidation and the nephrotoxicity of the sevoflurane degradation product fluoromethyl-2,2-difluoro-1-(trifluoromethyl)vinyl ether (compound A) in rats. *Chem. Res. Toxicol.* **17**(9), 1177–1189.
- Shin, Y.S., Miller, R.D., Caldwell, J.E., and Eger, E.I., II. (1992). The neuromuscular effects of sevoflurane and isoflurane alone and in combination with vecuronium or atracurium in the rat. *J. Anesth.* **6**(1), 1–8.

- Shuey, D.L., Woodland, C., Tremblay, C., Gregson, R., and Gerson, R.J. (2007). Oxymorphone hydrochloride, a potent opioid analgesic, is not carcinogenic in rats or mice. *Toxicol. Sci.* **96**(1), 162–173.
- Silverman, J., Huhndorf, M., Balk, M., and Slater, G. (1983). Evaluation of a combination of tiletamine and zolazepam as an anesthetic for laboratory rodents. *Lab. Anim. Sci.* **33**(5), 457–460.
- Silverman, J., and Ingram, L. (1986). Ketamine and xylazine anesthesia of the deer mouse. *Lab. Anim. Sci.* **36**(5), 539–540.
- Silverman, J., and Muir, W.W., III. (1993). A review of laboratory animal anesthesia with chloral hydrate and chloralose. *Lab. Anim. Sci.* **43**(3), 210–216.
- Silverman, J., Schucker, A.E., Anestidou, L., and Villarreal Acosta, Y. (2003). Anesthetics in GEM: does TBE make the grade? *Lab. Anim. (NY)* **32**(2), 19–21.
- Simpson, D.P. (1997). Prolonged (12 hours) intravenous anesthesia in the rat. *Lab. Anim. Sci.* **47**(5), 519–523.
- Sintov, A.C., and Shapiro, L. (2004). New microemulsion vehicle facilitates percutaneous penetration in vitro and cutaneous drug bioavailability in vivo. *J. Control. Release* **95**(2), 173–183.
- Skeehan, T.M., Schuler, H.G., and Riley, J.L. (1995). Comparison of the alteration of cardiac function by sevoflurane, isoflurane, and halothane in the isolated working rat heart. *J. Cardiothorac. Vasc. Anesth.* **9**(6), 706–712.
- Skornik, W.A., and Brain, J.D. (1990). Breathing and lung mechanics in hamsters: Effect of pentobarbital anesthesia. *J. Appl. Physiol.* **68**(6), 2536–2541.
- Sluka, K.A., and Chandran, P. (2002). Enhanced reduction in hyperalgesia by combined administration of clonidine and TENS. *Pain* **100**(1–2), 183–190.
- Smiler, K.L., Stein, S., Hrapkiewicz, K.L., and Hiben, J.R. (1990). Tissue response to intramuscular and intraperitoneal injections of ketamine and xylazine in rats. *Lab. Anim. Sci.* **40**(1), 60–64.
- Smith, D.E., Blumberg, J.B., and Lipman, R.D. (1999). Improved survival rates in mice that received prophylactic fluids after carcinogen treatment. *Contemp. Top. Lab. Anim. Sci.* **38**(1), 84–86.
- Smith, J.A. (1993). Anesthetic pollution and waste anesthetic gas scavenging. *Semin. Vet. Med. Surg. (Small Anim.)* **8**, 90–103.
- Smith, J.C., and Bolon, B. (2003). Comparison of three commercially available activated charcoal canisters for passive scavenging of waste isoflurane during conventional rodent anesthesia. *Contemp. Top. Lab. Anim. Sci.* **42**(2), 10–15.
- Smith, J.C., Corbin, T.J., McCabe, J.G., and Bolon, B. (2004). Isoflurane with morphine is a suitable anaesthetic regimen for embryo transfer in the production of transgenic rats. *Lab. Anim.* **38**(1), 38–43.
- Smith, L.J., Krugner-Higby, L., Clark, M., Wendland, A., and Heath, T.D. (2003). A single dose of liposome-encapsulated oxymorphone or morphine provides long-term analgesia in an animal model of neuropathic pain. *Comp. Med.* **53**(3), 280–287.
- Smith, L.J., Shih, A., Miletic, G., and Miletic, V. (2002). Continual systemic infusion of lidocaine provides analgesia in an animal model of neuropathic pain. *Pain* **97**(3), 267–273.
- Smith, L.J., Valenzuela, J.R., Krugner-Higby, L.A., Brown, C., and Heath, T.D. (2006). A single dose of liposome-encapsulated hydromorphone provides extended analgesia in a rat model of neuropathic pain. *Comp. Med.* **56**(6), 487–492.
- Smith, M.A., and French, A.M. (2002). Age-related differences in sensitivity to the antinociceptive effects of kappa opioids in adult male rats. *Psychopharmacology (Berl.)* **162**(3), 255–264.
- Smith, M.A., and Gray, J.D. (2001). Age-related differences in sensitivity to the antinociceptive effects of opioids in male rats. Influence of nociceptive intensity and intrinsic efficacy at the mu receptor. *Psychopharmacology (Berl.)* **156**(4), 445–453.
- Smith, M.A., and Yancey, D.L. (2003). Sensitivity to the effects of opioids in rats with free access to exercise wheels: Mu-opioid tolerance and physical dependence. *Psychopharmacology (Berl.)* **168**(4), 426–434.
- Sonner, J.M., Gong, D., and Eger, E.I., II (2000). Naturally occurring variability in anesthetic potency among inbred mouse strains. *Anesth. Analg.* **91**(3), 720–726.
- Sonner, J.M., Gong, D., Li, J., Eger, E.I., II, and Laster, M.J. (1999). Mouse strain modestly influences minimum alveolar anesthetic concentration and convulsivity of inhaled compounds. *Anesth. Analg.* **89**(4), 1030–1034.
- Sorahan, T., and Pope, D. (1993). Mortality and cancer morbidity of production workers in the United Kingdom flexible polyurethane foam industry. *Br. J. Ind. Med.* **50**(6), 528–536.
- Stackman, R.W., and Walsh, T.J. (1992). Chlordiazepoxide-induced working memory impairments: Site specificity and reversal by flumazenil (RO15-1788). *Behav. Neural Biol.* **57**(3), 233–243.
- Statler, K.D., Alexander, H., Vagni, V., Dixon, C.E., Clark, R.S., Jenkins, L., and Kochanek, P.M. (2006). Comparison of seven anesthetic agents on outcome after experimental traumatic brain injury in adult, male rats. *J. Neurotrauma* **23**(1), 97–108.
- Steffey, M.A., Brosnan, R.J., and Steffey, E.P. (2003). Assessment of halothane and sevoflurane anesthesia in spontaneously breathing rats. *Am. J. Vet. Res.* **64**(4), 470–474.
- Sternberg, W.F., and Liebeskind, J.C. (1995). The analgesic response to stress: Genetic and gender considerations. *Eur. J. Anaesthesiol. Suppl.* **10**, 14–17.
- Sternberg, W.F., and Ridgway, C.G. (2003). Effects of gestational stress and neonatal handling on pain, analgesia, and stress behavior of adult mice. *Physiol. Behav.* **78**(3), 375–383.
- Sternberg, W.F., Ritchie, J., and Mogil, J.S. (2004). Qualitative sex differences in kappa-opioid analgesia in mice are dependent on age. *Neurosci. Lett.* **363**(2), 178–181.
- Sternberg, W.F., Scorr, L., Smith, L.D., Ridgway, C.G., and Stout, M. (2005). Long-term effects of neonatal surgery on adulthood pain behavior. *Pain* **113**(3), 347–353.
- Stevenson, G.W., Bilsky, E.J., and Negus, S.S. (2006). Targeting pain-suppressed behaviors in preclinical assays of pain and analgesia: Effects of morphine on acetic acid-suppressed feeding in C57BL/6J mice. *J. Pain* **7**(6), 408–416.
- Stewart, A.S.L., and Martin, W.J. (2003a). Evaluation of postoperative analgesia in a rat model of incisional pain. *Contemp. Top. Lab. Anim. Sci.* **42**(1), 28–34.
- Stewart, L.S., and Martin, W.J. (2003b). Influence of postoperative analgesics on the development of neuropathic pain in rats. *Comp. Med.* **53**(1), 29–36.
- Stringer, S.K., and Seligmann, B.E. (1996). Effects of two injectable anesthetic agents on coagulation assays in the rat. *Lab. Anim. Sci.* **46**(4), 430–433.
- Suganuma, T., Suzuki, T., Oshimi, M., and Hanano, M. (1998). Change of beta-endorphin concentration in rat brain after administration of indomethacin or carrageenin. *Biol. Pharm. Bull.* **21**(7), 756–760.
- Sun, F.J., Wright, D.E., and Pinson, D.M. (2003). Comparison of ketamine versus combination of ketamine and medetomidine in injectable anesthetic protocols: Chemical immobilization in macaques and tissue reaction in rats. *Contemp. Top. Lab. Anim. Sci.* **42**(4), 32–37.
- Sunaga, H., Kaneko, M., and Amaki, Y. (2006). The efficacy of intratracheal administration of vecuronium in rats, compared with intravenous and intramuscular administration. *Anesth. Analg.* **103**(3), 601–607.
- Szczensy, G., Veihelmann, A., Massberg, S., Nolte, D., and Massmer, K. (2004). Long-term anesthesia using inhalatory isoflurane in different strains of mice—The haemodynamic effects. *Lab. Anim.* **38**(1), 64–69.
- Taira, Y., Nakakimura, K., Matsumoto, M., and Sakabe, T. (2000). Spinal and supraspinal midazolam potentiates antinociceptive effects of isoflurane. *Br. J. Anaesth.* **85**(6), 881–886.
- Takada, K., Clark, D.J., Davies, M.F., Tonner, P.H., Krause, T.K., Bertaccini, E., and Maze, M. (2002). Meperidine exerts agonist activity at the alpha(2B)-adrenoceptor subtype. *Anesthesiology* **96**(6), 1420–1426.
- Takahashi, K., Shigemori, S., Nosaka, S., Morikawa, S., and Inubushi, T. (1997). The effects of halothane and isoflurane on the phosphoenergetic state of the liver during hemorrhagic shock in rats: An in vivo ³¹P nuclear magnetic resonance spectroscopic study. *Anesth. Analg.* **85**(2), 347–352.
- Takahashi, M., Kawaguchi, M., Shimada, K., Nakashima, T., and Furuya, H. (2005). Systemic meloxicam reduces tactile allodynia development after

- L5 single spinal nerve injury in rats. *Reg. Anesth. Pain Med.* **30**(4), 351–355.
- Tanaka, T., Ogli, K., Komatsu, H., Nogaya, J., and Yokono, S. (1993). Strain-differences of sensitivity to volatile anesthetics and their genetic character in mice. *J. Anesth.* **7**(1), 75–81.
- Tatsuo, M.A., Carvalho, W.M., Silva, C.V., Miranda, A.E., Ferreira, S.H., and Francischi, J.N. (1994). Analgesic and antiinflammatory effects of dipyrone in rat adjuvant arthritis model. *Inflammation* **18**(4), 399–405.
- Taylor, J., Mellstrom, B., Fernaud, I., and Naranjo, J.R. (1998). Metamizol potentiates morphine effects on visceral pain and evoked c-Fos immunoreactivity in spinal cord. *Eur. J. Pharmacol.* **351**(1), 39–47.
- Taylor, R., Hayes, K.E., and Toth, L.A. (2000). Evaluation of an anesthetic regimen for retroorbital blood collection from mice. *Contemp. Top. Lab. Anim. Sci.* **39**(2), 14–17.
- Terner, J.M., Barrett, A.C., Grossell, E., and Picker, M.J. (2002). Influence of gonadectomy on the antinociceptive effects of opioids in male and female rats. *Psychopharmacology (Berl.)* **163**(2), 183–193.
- Themistocleous, A., Kamerman, P., and Mitchell, D. (2007). Pre-emptive ring-block with bupivacaine prevents the development of thermal hyperalgesia, but not sustained mechanical hyperalgesia, in rat tails exposed to ultraviolet A light. *J. Pain* **8**(3), 208–214.
- Thompson, A.C., DiPirro, J.M., Sylvester, A.R., Martin, L.B., and Kristal, M.B. (2006). Lack of analgesic efficacy in female rats of the commonly recommended oral dose of buprenorphine. *J. Am. Assoc. Lab. Anim. Sci.* **45**(6), 13–16.
- Thompson, A.C., Kristal, M.B., Sallaj, A., Acheson, A., Martin, L.B., and Martin, T. (2004). Analgesic efficacy of orally administered buprenorphine in rats: Methodologic considerations. *Comp. Med.* **54**(3), 293–300.
- Thompson, J.S., Brown, S.A., Khurdayan, V., Zeynalzadegan, A., Sullivan, P.G., and Scheff, S.W. (2002). Early effects of tribromoethanol, ketamine/xylazine, pentobarbitol, and isoflurane anesthesia on hepatic and lymphoid tissue in ICR mice. *Comp. Med.* **52**(1), 63–67.
- Thornton, S.R., Compton, D.R., and Smith, F.L. (1998). Ontogeny of mu opioid agonist anti-nociception in postnatal rats. *Brain Res. Dev. Brain Res.* **105**(2), 269–276.
- Thurmon, J.C., Tranquilli, W.J., and Benson, G.J. (1996a). Preanesthetics and anesthetic adjuvants. In “Lumb & Jones’ Veterinary Anesthesia.” 3rd ed., pp. 183–209. Williams & Wilkins.
- Thurmon, J.C., Tranquilli, W.J., and Benson, G.J. (1996b). Injectable anesthetics. In “Lumb & Jones’ Veterinary Anesthesia.” 3rd ed., pp. 210–240. Williams & Wilkins.
- Tokuyama, S., Inoue, M., Fuchigami, T., and Ueda, H. (1998). Lack of tolerance in peripheral opioid analgesia in mice. *Life Sci.* **62**(17–18), 1677–1681.
- Torjman, M.C., Joseph, J.I., Munsick, C., Morishita, M., and Grunwald, Z. (2005). Effects of isoflurane on gastrointestinal motility after brief exposure in rats. *Int. J. Pharm.* **294**(1–2), 65–71.
- Torres-Lopez, J.E., Ortiz, M.I., Castaneda-Hernandez, G., Alonso-Lopez, R., Asomoza-Espinosa, R., and Granados-Soto, V. (2002). Comparison of the antinociceptive effect of celecoxib, diclofenac and resveratrol in the formalin test. *Life Sci.* **70**(14), 1669–1676.
- Tortorici, V., and Vanegas, H. (1994). Putative role of medullary off- and on-cells in the antinociception produced by dipyrone (metamizol) administered systemically or microinjected into PAG. *Pain* **57**(2), 197–205.
- Tortorici, V., Vasquez, E., and Vanegas, H. (1996). Naloxone partial reversal of the antinociception produced by dipyrone microinjected into the periaqueductal gray of rats. Possible involvement of medullary off- and on-cells. *Brain Res.* **725**(1), 106–110.
- Towett, P.K., and Kanui, T.I. (1993). Effects of pethidine, acetylsalicylic acid, and indomethacin on pain and behavior in the mole-rat. *Pharmacol. Biochem. Behav.* **45**(1), 153–159.
- Tsutsumi, Y.M., Patel, H.H., Huang, D., and Roth, D.M. (2006a). Role of 12-lipoxygenase in volatile anesthetic-induced delayed preconditioning in mice. *Am. J. Physiol. Heart Circ. Physiol.* **291**(2), H979–H983.
- Tsutsumi, Y.M., Patel, H.H., Lai, N.C., Takahashi, T., Head, B.P., and Roth, D.M. (2006b). Isoflurane produces sustained cardiac protection after ischemia-reperfusion injury in mice. *Anesthesiology* **104**(3), 495–502.
- Turner, P.V., and Albassam, M.A. (2005). Susceptibility of rats to corneal lesions after injectable anesthesia. *Comp. Med.* **55**(2), 175–182.
- Ullman-Cullere, M.H., and Foltz, C.J. (1999). Body condition scoring: A rapid and accurate method for assessing health status in mice. *Lab. Anim. Sci.* **49**(3), 319–323.
- Vaccarino, A.L., Tasker, R.A., and Melzack, R. (1988). Systemic administration of naloxone produces analgesia in BALB/c mice in the formalin pain test. *Neurosci. Lett.* **84**(1), 103–107.
- Vahl, T.P., Ulrich-Lai, Y.M., Ostrander, M.M., Dolgas, C.M., Elfers, E.E., Seeley, R.J., D’Alessio, D.A., and Herman, J.P. (2005). Comparative analysis of ACTH and corticosterone sampling methods in rats. *Am. J. Physiol. Endocrinol. Metab.* **289**(5), E823–E828.
- Vaillancourt, C., Berger, N., and Boksa, P. (1999). Effects of vaginal birth versus caesarean section birth with general anesthesia on blood gases and brain energy metabolism in neonatal rats. *Exp. Neurol.* **160**(1), 142–150.
- Vanegas, H., and Tortorici, V. (2002). Opioidergic effects of nonopioid analgesics on the central nervous system. *Cell. Mol. Neurobiol.* **22**(5–6), 655–661.
- Van Loveren, H., Gianotten, N., Hendriksen, C.F., Schuurman, H.J., and Van der Laan, J.W. (1994). Assessment of immunotoxicity of buprenorphine. *Lab. Anim.* **28**(4), 355–363.
- Van Pelt, L.F. (1977). Ketamine and xylazine for surgical anesthesia in rats. *J. Am. Vet. Med. Assoc.* **171**(9), 842–844.
- Veiga, A.P., Duarte, I.D., Avila, M.N., da Motta, P.G., Tatsuo, M.A., and Francischi, J.N. (2004). Prevention by celecoxib of secondary hyperalgesia induced by formalin in rats. *Life Sci.* **75**(23), 2807–2817.
- Vella, E.T., Evans, C.C., Williams, S., and Wynne-Edwards, K.E. (2004). Neonatal anesthesia for studies of hamster parental behavior when infantile aggression is a possibility. *Comp. Med.* **54**(2), 202–208.
- Vergari, A., Gunnella, B., Rodola, F., Frassanito, L., Musumeci, M., Palazzesi, S., and Casalnuovo, I.A. (2004). A new method of orotracheal intubation in mice. *Eur. Rev. Med. Pharmacol. Sci.* **8**(3), 103–106.
- Vergari, A., Polito, A., Musumeci, M., Palazzesi, S., and Marano, G. (2003). Video-assisted orotracheal intubation in mice. *Lab. Anim.* **37**(3), 204–206.
- Verma-Gandhu, M., Bercik, P., Motomura, Y., Verdu, E.F., Khan, W.I., Blennerhassett, P.A., Wang, L., El-Sharkawy, R.T., and Collins, S.M. (2006). CD4+ T-cell modulation of visceral nociception in mice. *Gastroenterology* **130**(6), 1721–1728.
- Vickery, B. (1979). Prolongation of gestation in the rat and hamster by naproxen. *Prostaglandins Med.* **2**(5), 325–335.
- Vijaya Kumar, S.G., and Mishra, D.N. (2006). Analgesic, antiinflammatory, and ulcerogenic studies of meloxicam solid dispersion prepared with polyethylene glycol 6000. *Methods Find. Exp. Clin. Pharmacol.* **28**(7), 419–422.
- Virtanen, R. (1989). Pharmacological profiles of medetomidine and its antagonist, atipamezole. *Acta Vet. Scand. Suppl.* **85**, 29–37.
- Volker, D., Bate, M., Gentle, R., and Garg, M. (2000). Oral buprenorphine is anti-inflammatory and modulates the pathogenesis of streptococcal cell wall polymer-induced arthritis in the Lew/SSN rat. *Lab. Anim.* **34**(4), 423–429.
- Wakeno-Takahashi, M., Otani, H., Nakao, S., Imamura, H., and Shingu, K. (2005). Isoflurane induces second window of preconditioning through upregulation of inducible nitric oxide synthase in rat heart. *Am. J. Physiol. Heart Circ. Physiol.* **289**(6), H2585–H2591.
- Walker, J.S. (2003). Anti-inflammatory effects of opioids. *Adv. Exp. Med. Biol.* **521**, 148–160.
- Walker, J.S., Chandler, A.K., Wilson, J.L., Binder, W., and Day, R.O. (1996). Effect of mu-opioids morphine and buprenorphine on the development of adjuvant arthritis in rats. *Inflamm. Res.* **45**(11), 557–563.
- Wang, J.J., Sung, K.C., Hu, O.Y., Yeh, C.H., and Fang, J.Y. (2006). Submicron lipid emulsion as a drug delivery system for nalbuphine and its prodrugs. *J. Control. Release* **115**(2), 140–149.

- Ward, G.S., Johnsen, D.O., and Roberts, C.R. (1974). The use of CI 744 as an anesthetic for laboratory animals. *Lab. Anim. Sci.* **24**(5), 732–742.
- Watkins, J.C., and Jane, D.E. (2006). The glutamate story. *Br. J. Pharmacol.* **147**, S100–S108.
- Weber, N.C., Toma, O., Wolter, J.I., Obal, D., Mullenheim, J., Preckel, B., and Schlack, W. (2005). The noble gas xenon induces pharmacological preconditioning in the rat heart in vivo via induction of PKC-epsilon and p38 MAPK. *Br. J. Pharmacol.* **144**(1), 123–132.
- Weichbrod, R.H., Cisar, C.F., Miller, J.G., Simmonds, R.C., Alvares, A.P., and Ueng, T.H. (1988). Effects of cage beddings on microsomal oxidative enzymes in rat liver. *Lab. Anim. Sci.* **38**(3), 296–298.
- Weinandy, R., Fritzsche, P., Weinert, D., Wenkel, R., and Gattermann, R. (2005). Indicators for post-surgery recovery in Mongolian gerbils (*Meriones unguiculatus*). *Lab. Anim.* **39**(2), 200–208.
- Weinger, M.B., Partridge, B.L., and Henry, A.F. (1995). Dexmedetomidine does not modify the neuromuscular blocking action of vecuronium in the anaesthetized rat. *Br. J. Anaesth.* **74**(4), 455–457.
- Weiss, J., and Zimmermann, F. (1999). Tribromoethanol (Avertin) as an anaesthetic in mice. *Lab. Anim.* **33**(2), 192–193.
- Weksler, B., Ng, B., Lenert, J., and Burt, M. (1994). A simplified method for endotracheal intubation in the rat. *J. Appl. Physiol.* **76**(4), 1823–1825.
- Welberg, L.A., Kinkead, B., Thirivikraman, K., Huerkamp, M.J., Nemeroff, C.B., and Plotsky, P.M. (2006). Ketamine–xylazine–acepromazine anesthesia and postoperative recovery in rats. *J. Am. Assoc. Lab. Anim. Sci.* **45**(2), 13–20.
- West, C.D., and Green, C.J. (1987). The sedative effects of clizolam and clizolam with fentanyl-fluanisone in rats (*Rattus norvegicus*). *Lab. Anim.* **21**(2), 143–148.
- West, J.P., Dykstra, L.A., and Lysle, D.T. (1998). Differential tolerance to morphine's immunomodulatory effects following continuous administration. *Drug Alcohol Depend.* **53**(1), 31–38.
- White, W.J., and Field, K.J. (1987). Anesthesia and surgery of laboratory animals. *Vet. Clin. North Am. Small Anim. Pract.* **17**(5), 989–1017.
- Whiteside, G.T., Harrison, J., Boulet, J., Mark, L., Pearson, M., Gottshall, S., and Walker, K. (2004). Pharmacological characterisation of a rat model of incisional pain. *Br. J. Pharmacol.* **141**(1), 85–91.
- Whittington, R.A., and Virag, L. (2006). Isoflurane decreases extracellular serotonin in the mouse hippocampus. *Anesth. Analg.* **103**(1), 92–98.
- Wiesmann, F., Ruff, J., Hiller, K.H., Rommel, E., Haase, A., and Neubauer, S. (2000). Developmental changes of cardiac function and mass assessed with MRI in neonatal, juvenile, and adult mice. *Am. J. Physiol. Heart Circ. Physiol.* **278**(2), H652–H657.
- Wilhelm, S., Ma, D., Maze, M., and Franks, N.P. (2002). Effects of xenon on in vitro and in vivo models of neuronal injury. *Anesthesiology* **96**(6), 1485–1491.
- Williams, J.L., Baez, C., Hladky, K.J., and Camacho, C.A. (2005). Effects of synthetic predator odor (TMT) on freezing, analgesia, stereotypy, and spatial memory. *Psychol. Rec.* **55**(1), 3–38.
- Wilson, A.W., Medhurst, S.J., Dixon, C.I., Bontoft, N.C., Winyard, L.A., Brackborough, K.T., De Alba, J., Clarke, C.J., Gunthorpe, M.J., Hicks, G.A. et al. (2006). An animal model of chronic inflammatory pain: pharmacological and temporal differentiation from acute models. *Eur. J. Pain* **10**(6), 537–549.
- Wilson, R.P., Zagon, I.S., Larach, D.R., and Lang, C.M. (1992). Antinociceptive properties of tiletamine–zolazepam improved by addition of xylazine or butorphanol. *Pharmacol. Biochem. Behav.* **43**(4), 1129–1133.
- Wilson, S.G., Smith, S.B., Chesler, E.J., Melton, K.A., Haas, J.J., Mitton, B., Strasburg, K., Hubert, L., Rodriguez-Zas, S.L., and Mogil, J.S. (2003). The heritability of antinociception: Common pharmacogenetic mediation of five neurochemically distinct analgesics. *J. Pharmacol. Exp. Ther.* **304**(2), 547–559.
- Wixson, S.K., and Smiler, K.L. (1997). Anesthesia and analgesia in rodents. In "Anesthesia and Analgesia of Laboratory Animals." (D.F. Kohn, S.K. Wixson, W.J. White, G.J. Benson, eds.), pp. 166–203. Academic Press.
- Wixson, S.K., White, W.J., Hughes, H.C., Jr., Lang, C.M., and Marshall, W.K. (1987a). A comparison of pentobarbital, fentanyl–droperidol, ketamine–xylazine and ketamine–diazepam anesthesia in adult male rats. *Lab. Anim. Sci.* **37**(6), 726–730.
- Wixson, S.K., White, W.J., Hughes, H.C., Jr., Lang, C.M., and Marshall, W.K. (1987b). The effects of pentobarbital, fentanyl–droperidol, ketamine–xylazine and ketamine–diazepam on arterial blood pH, blood gases, mean arterial blood pressure and heart rate in adult male rats. *Lab. Anim. Sci.* **37**(6), 736–742.
- Wixson, S.K., White, W.J., Hughes, H.C., Jr., Lang, C.M., and Marshall, W.K. (1987c). The effects of pentobarbital, fentanyl–droperidol, ketamine–xylazine and ketamine–diazepam on core and surface body temperature regulation in adult male rats. *Lab. Anim. Sci.* **37**(6), 743–749.
- Wixson, S.K., White, W.J., Hughes, H.C., Jr., Marshall, W.K., and Lang, C.M. (1987d). The effects of pentobarbital, fentanyl–droperidol, ketamine–xylazine and ketamine–diazepam on noxious stimulus perception in adult male rats. *Lab. Anim. Sci.* **37**(6), 731–735.
- Wood, A.K., Klide, A.M., Pickup, S., and Kundel, H.L. (2001). Prolonged general anesthesia in MR studies of rats. *Acad. Radiol.* **8**(11), 1136–1140.
- Woolfolk, D.R., and Holtzman, S.G. (1995). Rat strain differences in the potentiation of morphine-induced analgesia by stress. *Pharmacol. Biochem. Behav.* **51**(4), 699–703.
- Wright-Williams, S.L., Courade, J.P., Richardson, C.A., Roughan, J.V., and Flecknell, P.A. (2006). Effects of vasectomy surgery and meloxicam treatment on faecal corticosterone levels and behaviour in two strains of laboratory mouse. *Pain*, **130**(1–2), 108–118.
- Yamakage, M., Tsujiguchi, N., Chen, X., Kamada, Y., and Namiki, A. (2002). Sevoflurane inhibits contraction of uterine smooth muscle from pregnant rats similarly to halothane and isoflurane. *Can. J. Anaesth.* **49**(1), 62–66.
- Yamasaki, A., Takahashi, T., Suzuki, T., Fujiwara, T., Hirakawa, M., Ohmori, E., and Akagi, R. (2001). Differential effects of isoflurane and halothane on the induction of heat shock proteins. *Biochem. Pharmacol.* **62**(3), 375–382.
- Yamasaki, K., Kuroe, K., and Kamimura, R. (2003). A new method of inhalation anesthesia with nasopharyngeal insufflation in rat experiment. *Exp. Anim.* **52**(4), 349–351.
- Yang, J., Liu, W.Y., Song, C.Y., and Lin, B.C. (2006). Through central arginine vasopressin, not oxytocin and endogenous opiate peptides, glutamate sodium induces hypothalamic paraventricular nucleus enhancing acupuncture analgesia in the rat. *Neurosci. Res.* **54**(1), 49–56.
- Yokoro, C.M., Tatsuo, M.A., Pereira, L.S., Alves, D.L., and Francischi, J.N. (2003). Role of endogenous glucocorticoids in hyperalgesia and edema in old arthritic rats. *Braz. J. Med. Biol. Res.* **36**(1), 77–83.
- Yu, J., Ogawa, K., Tokinaga, Y., Iwahashi, S., and Hatano, Y. (2004). The vascular relaxing effects of sevoflurane and isoflurane are more important in hypertensive than in normotensive rats. *Can. J. Anaesth.* **51**(10), 979–985.
- Zagon, I.S., Tobias, S.W., Hytrek, S.D., and McLaughlin, P.J. (1998). Opioid receptor blockade throughout prenatal life confers long-term insensitivity to morphine and alters mu opioid receptors. *Pharmacol. Biochem. Behav.* **59**(1), 201–207.
- Zambricki, E.A., and Daley, L.G. (2004). Rat sex differences in anesthesia. *Comp. Med.* **54**(1), 49–53.
- Zatzman, M.L., and Thornhill, G.V. (1988). Effects of anesthetics on cardiovascular responses of the marmot *Marmota flaviventris*. *Cryobiology* **25**(3), 212–226.
- Zelcer, S., Kolesnikov, Y., Kovalyshyn, I., Pasternak, D.A., and Pasternak, G.W. (2005). Selective potentiation of opioid analgesia by nonsteroidal anti-inflammatory drugs. *Brain Res.* **1040**(1–2), 151–156.
- Zeller, W., Meier, G., Burki, K., and Panoussis, B. (1998). Adverse effects of tribromoethanol as used in the production of transgenic mice. *Lab. Anim.* **32**(4), 407–413.
- Zhan, X., Fahlman, C.S., and Bickler, P.E. (2006). Isoflurane neuroprotection in rat hippocampal slices decreases with aging: Changes in intracellular Ca²⁺ regulation and N-methyl-D-aspartate receptor-mediated Ca²⁺ influx. *Anesthesiology* **104**(5), 995–1003.

- Zhang, R.X., Lao, L., Wang, X., Ren, K., and Berman, B.B. (2004). Electroacupuncture combined with indomethacin enhances antihyperalgesia in inflammatory rats. *Pharmacol. Biochem. Behav.* **78**(4), 793–797.
- Zhang, Y., Eger, E.I., Dutton, R.C., and Sonner, J.M. (2000). Inhaled anesthetics have hyperalgesic effects at 0.1 minimum alveolar anesthetic concentration. *Anesth. Analg.* **91**(2), 462–466.
- Zhao, C., Wacnik, P.W., Tall, J.M., Johns, D.C., Wilcox, G.L., Meyer, R.A., and Raja, S.N. (2004). Analgesic effects of a soy-containing diet in three murine bone cancer pain models. *J. Pain* **5**(2), 104–110.
- Zhao, P., and Zuo, Z. (2004). Isoflurane preconditioning induces neuroprotection that is inducible nitric oxide synthase-dependent in neonatal rats. *Anesthesiology* **101**(3), 695–703.
- Zhou, J.X., Luo, N.F., Liang, X.M., and Liu, J. (2006). The efficacy and safety of intravenous emulsified isoflurane in rats. *Anesth. Analg.* **102**(1), 129–134.
- Zhu, C.B., Li, X.Y., Zhu, Y.H., and Xu, S.F. (1995). Binding sites of mu receptor increased when acupuncture analgesia was enhanced by droperidol: an autoradiographic study. *Zhongguo Yao Li Xue Bao* **16**(4), 311–314.
- Zuurbier, C.J., Emons, V.M., and Ince, C. (2002). Hemodynamics of anesthetized ventilated mouse models: Aspects of anesthetics, fluid support, and strain. *Am. J. Physiol. Heart Circ. Physiol.* **282**(6), H2099–H2105.
- Zvara, D.A., Bryant, A.J., Deal, D.D., DeMarco, M.P., Campos, K.M., Mansfield, C.M., and Tytell, M. (2006). Anesthetic preconditioning with sevoflurane does not protect the spinal cord after an ischemic-reperfusion injury in the rat. *Anesth. Analg.* **102**(5), 1341–1347.

This page intentionally left blank

Chapter 11

Anesthesia and Analgesia in Rabbits

Neil S. Lipman, Robert P. Marini, and Paul A. Flecknell

I. Introduction	300
II. Preoperative Considerations	300
A. Choice of Subject	300
B. Patient Evaluation and Preparation	300
C. Premedication	301
III. Methods of Delivery/Administration	306
A. Injection Sites	306
B. Intranasal Administration	307
C. Tracheal Access	307
IV. Parenteral Techniques	310
A. Barbiturates	310
B. Dissociatives	312
C. Neuroleptanalgesia/Neuroleptanesthesia	314
D. Miscellaneous Agents	315
V. Inhalation Anesthesia	317
VI. Regional Anesthesia	319
A. Local or Regional Anesthesia	319
B. Spinal Anesthesia	319
VII. Special Anesthetic Considerations	320
A. Hypnosis	320
B. Anesthesia during Ophthalmic Procedures	320
C. Anesthesia for Fetal Surgery	320
D. Long-Term Anesthetic Preparations	321
VIII. Intraoperative Support and Monitoring	321
A. Reflexes	322
B. Body Temperature	322
C. Cardiopulmonary Parameters	322
IX. Postoperative Considerations	323
X. Analgesia	324
A. Pain Assessment	324
B. Selection of Analgesics	324
References	327

I. INTRODUCTION

Rabbits are routinely utilized as research subjects for in vivo studies. Their popularity is a result of availability, cost, size, ease of handling, vascular access, and a variety of specific anatomical, physiological, and biochemical features. Their use requires the routine administration of pharmacologic agents for restraint, vascular access, surgery, and pain relief. The rabbit is reputed to be one of the most difficult laboratory animals to anesthetize. Numerous literature citations attribute this difficulty to individual as well as strain- and sex-specific variation in response to anesthetic agents, enhanced sensitivity of the brainstem to respiratory depression, and anatomic features making endotracheal (ET) intubation difficult (Avsaroglu et al., 2003; Chen and Bohner, 1968; Gardner, 1964; Gay, 1963; Green, 1982b; Murdock, 1969). Most of these characteristics, which apply only to the use of pentobarbital or to rabbits that were compromised with pneumonia, have unfairly stigmatized the rabbit, which can be easily and safely anesthetized for a wide variety of procedures. In fact, rabbits are routinely used as an animal model to investigate and define the physiologic effects of new anesthetics and analgesics (Bernards and Artru, 1991; Blake et al., 1991; Chakrabarty et al., 1991; Dhasmana et al., 1984; Dollo et al., 2004a; 2004b; Dorward et al., 1987; Drummond et al., 1987; Harris and Best, 1979; Hartikainen et al., 1995; Hess et al., 1971, 1981; Horita et al., 1983; Hovav and Weinstock, 1987; Lockhart et al., 1991; Maggi et al., 1984; McGraph and MacKenzie, 1977; Mills et al., 1987; Morita et al., 1987; Orszulak-Michalak, 1996; Patel and Mutch, 1990; Ruta and Mutch, 1989; Sainz et al., 1987; Warren and Ledingham, 1978; Wyler and Weisser, 1972).

In this second edition, we have updated our previous chapter, in which we review the topic of anesthesia and analgesia as it pertains to the rabbit. Biomethodology, pre-, intra-, and postoperative considerations, and special anesthetic procedures will also be discussed. This chapter gives the reader a general overview of the subject; detailed information should be sought from the references provided. Since the science of anesthesia is constantly changing, the reader should also consult pertinent journals for "state-of-the-art" information. The tables in this chapter can be consulted for quick reference to the agents and doses used for sedation, tranquilization, anesthesia, and analgesia in rabbits.

II. PREOPERATIVE CONSIDERATIONS

A. Choice of Subject

The selection of the experimental subject is as important as the choice of the appropriate anesthetic agent. Rabbits may be infected with a variety of agents that can have an adverse impact on anesthesia; as an example, *Pasteurella multocida* causes a variety of clinical syndromes, including pneumonia.

Rabbits may appear clinically normal despite significant respiratory pathology. These rabbits may fail to respire spontaneously once anesthetized, because the animal has adapted to hypercapnia resulting from pulmonary insufficiency (Sedgwick, 1986). The careful selection, purchase, and maintenance of *specific pathogen free* (SPF) rabbits will eliminate the risks associated with using animals that are compromised by pathogens.

Breed selection is frequently mandated by the size of the desired subject, specific anatomical or physiological features, and availability. The New Zealand white and Dutch belted remain the most frequently used breeds for research in the United States. These outbred stocks are maintained by a variety of vendors in closed colonies; genetic differences do exist in members of the same stock obtained from different vendors. The choice of sex may also be a consideration. Cyclic hormonal changes occur in does during the estrus cycle, which may have subtle effects that can alter research or anesthetic responses (Lawson, 1985). Diurnal and seasonal effects may also contribute to response variation (Deimling and Schnell, 1980; Hastings and Menaker, 1976; Jori et al., 1971; Radzialowski and Bousquet, 1968; Scheving et al., 1968).

Sufficient time should be allotted when planning and scheduling experimental procedures to allow for stabilization following shipment and acclimation to a new environment. Stress from shipment and handling may result in increased levels of circulating catecholamines, which may adversely affect the anesthetic course. Ideally, rabbits should be quarantined for a minimum of 72 hours, habituated to handling, and evaluated clinically before being subjected to anesthesia.

Animals with specialized anatomic, physiologic, or biochemical features may be required in studies utilizing anesthesia. These specialized characteristics may occur spontaneously or can be experimentally induced; examples include the Watanabe, a model of familial hypercholesteremia, the Adriamycin-induced model of cardiomyopathy, and the β -myosin heavy chain transgenic rabbit model of hypertrophic cardiomyopathy (Arnolda et al., 1985; Goldstein et al., 1983; Marian et al., 1999). Rabbits with these features should be evaluated preoperatively to anticipate special factors that may impact anesthesia. Steps may be required pre- and intraoperatively to ensure a stable course of anesthesia. Careful consideration should be given to the selection of the anesthetic agent. For example, xylazine has been shown to increase blood glucose levels, so its use should be avoided in the diabetic animal (Salonen, 1992); agents that reduce or minimally impact intracranial pressure should be selected for neurosurgical procedures; and consideration of the effect of anesthetic agents on intraocular pressure is important in ophthalmologic procedures.

B. Patient Evaluation and Preparation

Rabbits should be subject to, at a minimum, a physical examination prior to inclusion in an anesthetic protocol. The chest

should be auscultated carefully for evidence of pulmonary or cardiovascular disease and rectal temperature should be determined. Baseline laboratory evaluation including a complete blood count and serum biochemistry may be useful in animals that have been subject to prior manipulation. Rabbits with pasteurellosis are not good anesthetic candidates. Thoracic radiography to identify latent pulmonary consolidation and abscesses is advisable in rabbits from colonies with enzootic pasteurellosis. Specialized studies may require additional preoperative diagnostics.

There is no consensus on the withdrawal of food from rabbits preoperatively (Flecknell, 1987; Kaplan and Timmons, 1979). The rabbit is unable to vomit and its stomach does not empty despite 5 days of food withdrawal (Murdock, 1969). It has been theorized that a 12-hour fast yields more consistent anesthesia and the decreased stomach volume may aid respiration, as rabbits breathe primarily by diaphragmatic excursion. Blood glucose levels remain stable for up to 96 hours without eating (Kozma et al., 1974). However, rabbits weighing less than 3 kg develop metabolic acidosis and a significant decline in blood glucose levels as a result of food deprivation (Bonath et al., 1982). Rabbits weighing less than 2 kg are not able to compensate for the acidosis. It is recommended that rabbits weighing less than 3 kg not be fasted for longer than 12 hours (Bonath et al., 1982). Generally there is no need to remove water more than several hours before surgery.

C. Premedication

1. *Parasympatholytics*

Parasympatholytics may be employed to prevent bradycardia from vagal reflex and reduce salivary and bronchial secretions that can occlude the airway. Rabbits may produce atropinesterase (AtrE), which degrades atropine into inactive products. The presence of AtrE is inherited and is found in varying frequencies (up to 50%) in the sera and/or tissues of some rabbits in a variety of breeds (Ecobichon and Comeau, 1974). AtrE may be present in the liver and the brain without being detectable in the sera (Margolis and Fiegelson, 1963). AtrE activity in serum has been shown to increase with age from 3 to 10 weeks, at which time the maximal activity is reached (van Zutphen, 1972). At least three different phenotypes have been described with low, intermediate, and high levels of AtrE activity (Ecobichon and Comeau, 1974). The enzyme hydrolyzes other amino-alcohol esters and appears to be related to or identical to the enzyme cocaine esterase, which hydrolyzes cocaine (van Zutphen, 1972). In vitro and in vivo screening tests have been described for AtrE detection (Ecobichon and Comeau, 1974; Linn and Liebenberg, 1979; Tucker and Beattie, 1983; van Zutphen, 1972). A rapid screening test (in vivo) in which the presence of the pupillary light reflex is evaluated 45 minutes after receiving atropine sulfate (0.5 mg/kg subcutaneous, SC) has compared favorably to qualitative in vitro tests (Linn and

Liebenberg, 1979). The presence of AtrE has led some authors to recommend preoperative doses of atropine as high as 1–2 mg/kg (Hall and Clarke, 1991) and redosing as frequently as every 10–15 minutes (Sedgwick, 1986). Stampfi and Quon (1995) have suggested that the rabbit AtrE is actually a carboxylesterase that has been shown to hydrolyze fleistolol, an ultra short-acting beta blocker as well as other ester-containing compounds such as procaine. This may have clinical significance as the half-life of a variety of drugs, including the ester-type local anesthetics such as lidocaine, may be significantly reduced in rabbits with elevated concentrations of the carboxylesterase. Esterase activity has been found in various ocular tissues in both albino and pigmented rabbits, and would be expected to alter ocular drug bioavailability (Lee, 1983). The activity was higher in the pigmented rabbits and was greatest in the iris-ciliary body, followed by the cornea and the aqueous humor.

Glycopyrrolate, a quaternary ammonium with powerful antisialagogue activity and a more rapid onset than atropine, can be utilized in rabbits with AtrE. Glycopyrrolate was shown to be an effective anticholinergic agent in rabbits when administered at a dose of 0.1 mg/kg intramuscular (IM) (Olson et al., 1994). Glycopyrrolate produced a significantly elevated heart rate that lasted 60 minutes when administered alone to rabbits free of AtrE as determined by the in vivo screening test, while doses of atropine as high as 2 mg/kg did not. Glycopyrrolate also prevented the bradycardia associated with administration of ketamine/xylazine. It has been used as a mydriatic agent, providing a faster, stronger, and more persistent effect than atropine, lasting as long as 1 week without affecting intraocular pressure (Varsanno et al., 1996). Topically (ophthalmically) administered glycopyrrolate has systemic effects, as it causes mydriasis of the contralateral pupil (Ji et al., 2000).

2. *Tranquilizers/sedatives*

Tranquilizers/sedatives are frequently used as premedicants for anesthesia or alone for noninvasive procedures such as phlebotomy. Their use frequently reduces the dose of anesthetic and may counteract or limit the adverse effects of some agents (Table 11-1).

The *phenothiazine tranquilizers* (acepromazine, chlorpromazine, and propiopromazine) have been utilized alone or in combination with a variety of agents. Acepromazine has been extensively used in the rabbit (Dolowy and Hesse, 1959; Freeman et al., 1972; Lipman et al., 1990; Ludders et al., 1987; McCormick and Ashworth, 1971; Moore et al., 1987). Peripheral vasodilation, a result of adrenoceptor blockade, and sedation make it extremely useful for phlebotomy. It is used alone at doses of 0.25–0.75 mg/kg intravenous (IV), IM, or SC (Lipman, unpublished observations) and in combination with ketamine/xylazine at 1 mg/kg IM for blood collection (Ludders et al., 1987). Acepromazine significantly increased the duration and depth of anesthesia achieved with ketamine/xylazine and urethane (Lipman et al., 1990; Moore et al., 1987).

TABLE 11-1

REPORTED DOSES OF ANTICHOLINERGICS, SEDATIVES, TRANQUILIZERS, AND ANESTHETICS FOR CLINICAL USE IN THE RABBIT^a

Drug	Dosage	Route of administration	References
Anticholinergics			
Atropine	0.04–2.0 mg/kg (0.5 mg/kg commonly recommended)	IM, SC	Hall and Clarke, 1991
Glycopyrrolate	0.1 mg/kg	IM, SC	Olson et al., 1994
Sedatives/tranquilizers			
Diazepam	5–10 mg/kg	IM	Green et al., 1981; Sedgwick, 1986
	1–2 mg/kg	IM, IV	Flecknell et al., 1983
Midazolam	2 mg/kg	IP, IV	Flecknell and Mitchell, 1984
Acepromazine	0.75–10.0 mg/kg 0.75–1.0 mg/kg is most frequently used	IM	McCormick and Ashworth, 1971 Freeman et al., 1972
Chlorpromazine hydrochloride	25–100 mg/kg	IM	Bivin and Timmons, 1974; Dolowy and Hesse, 1959
Xylazine	3–9 mg/kg	IM, IV	Green, 1975; Sanford and Colby, 1980
Medetomidine	0.25 mg/kg 6 mg/kg	IM IV (1.25% sol slowly to allow endotracheal intubation)	Ko et al., 1992 Green, 1982b
Barbiturates			
Thiopental	15–30 mg/kg 50 mg/kg	IV (1% sol) GTE IV (2.5% sol) GTE	Clifford, 1984; Sedgwick, 1986 Lumb and Jones, 1984
Thiamylal sodium	15 mg/kg 29 mg/kg	IV (1% sol) GTE IV (2% sol) GTE	Clifford, 1984; Sedgwick, 1986 Gardner, 1964
EMTU	47.5 mg/kg	IV to effect	Hobbs et al., 1991
Methohexital	5–10 mg/kg	IV (1% sol) GTE	Antal, 1985; Green, 1975
Pentobarbital	20–60 mg/kg 30 mg/kg	IV IM	Borkowski et al., 1990; Conn and Langer, 1978; Flecknell et al., 1983; Green, 1975; Jacobs and Krohn, 1975; Koch and Dwyer, 1988; Marston et al., 1965; Peeters et al., 1988; Zhou et al., 1981 Krogh, 1975
Pentobarbital + Guafenesin	20 mg/kg 200 mg/kg	Intrahepatic IV	Jacobs and Krohn, 1975 Olson et al., 1987
Pentobarbital + Chlorpromazine	20–30 mg/kg 2 mg/kg	IV IM prior to pentobarbital	Green, 1975
Pentobarbital + Xylazine	11.8–28.4 mg/kg 5 mg/kg	IV SC followed in 10 minutes by pentobarbital	Hobbs et al., 1991
Pentobarbital + Ketamine +	30 mg/kg 10 mg/kg	IV IM administration 10 minutes following pentobarbital	Raman et al., 1989
1% Lidocaine hydrochloride	Local infiltration of surgical incision	SC	
Dissociatives			
Ketamine	20–60 mg/kg	IM	Clifford, 1984; Green, 1975, 1982b; Sedgwick, 1986
Ketamine + Xylazine	10 mg/kg 3 mg/kg	IV IV	Flecknell, 1987
Ketamine + Xylazine	22–50 mg/kg 2.5–10 mg/kg	IM	Clifford, 1984 Beyers et al., 1991; Koch and Dwyer, 1988; Lipman et al., 1990; Peeters et al., 1988; Popilskis et al., 1991; Rich et al., 1990; Sanford and Colby, 1980; Sedgwick, 1986; White and Holmes, 1976
Reverse with Yohimbine	0.2 mg/kg	IV	Lipman et al., 1987
Ketamine + Xylazine +	35–40 mg/kg 3–5 mg/kg	IM SC	Hobbs et al., 1991 Lipman et al., 1990
Acepromazine (preoperative with atropine, 0.04 mg/kg IM)	0.75–1.0 mg/kg	SC	Ludders et al., 1987
Ketamine + Acepromazine	75 mg/kg 5 mg/kg	IM IM (given 30 minutes prior to ketamine)	Clifford, 1984

(Continued)

TABLE 11-1

CONTINUED

Drug	Dosage	Route of administration	References
Ketamine + Xylazine + Buprenorphine	35 mg/kg 5 mg/kg 0.03 mg/kg	IM	Difilippo et al., 2004
Ketamine + Diazepam	60–80 mg/kg 5–10 mg/kg	IM IM (given 30 minutes prior to ketamine)	Sedgwick, 1986
Ketamine + Medetomidine + Diazepam	20 mg/kg 0.3 mg/kg 0.75–1.5 mg/kg	SC	Mero et al., 1989
Ketamine + EMTU (Inactin)	35 mg/kg 25–55 mg/kg	IM IV to effect	Hobbs et al., 1991
Ketamine + Pentobarbital	50 mg/kg 30 mg/kg	IM IM	Krogh, 1975
Ketamine + Chloral hydrate	20 mg/kg 250 mg/kg	IV IV	Chen and Bohner, 1968 Hobbs et al., 1991
Ketamine + Medetomidine	15–25 mg/kg 0.25–0.5 mg/kg	IM, SC IM, SC	Nevalainen et al., 1989 Orr et al., 2005
Reverse with Atipamezole	Up to 1 mg/kg	IM, SC, IV	Kim et al., 2004; Orr et al., 2005
Ketamine + Medetomidine + Buprenorphine	35 mg/kg 0.5 mg/kg 0.03 mg/kg	IM IM IM	Difilippo et al., 2004
Ketamine + Medetomidine + Butorphanol	15 mg/kg 0.25–0.5 mg/kg 0.4 mg/kg	IM, SC IM, SC SC	Hedenqvist et al., 2002
Tiletamine ^b + Zolazepam	32–64 mg/kg	IM	Brammer et al., 1991
Tiletamine ^b + Zolazepam +	15 mg/kg	IM (inject all simultaneously but use separate syringes)	Popilskis et al., 1991
Xylazine	5 mg/kg		
Neuroleptanalgesics			
Fentanyl–droperidol	0.125 mg/kg 0.15–0.44 ml/kg (0.22 ml/kg is optimal dose)	SC IM	Tillman and Norman, 1983 Bivin and Timmons, 1974; Lewis and Jennings, 1972; Strack and Kaplan, 1968; Walden, 1978
Fentanyl–fluanisone	0.2–0.6 ml/kg	IM, SC	Alberius et al., 1989; Flecknell, 1987; Flecknell et al., 1989; Green, 1975
Diazepam + Fentanyl–fluanisone	1.5–5 mg/kg 0.2–0.5 ml/kg (administer diazepam 5 minutes prior to fentanyl–fluanisone)	IM, IV, IP IM, SC	Green, 1975 Flecknell, 1987; Flecknell et al., 1983; Mero et al., 1987
Midazolam + Fentanyl–fluanisone	2 mg/kg 0.3 ml/kg (administer midazolam 5 minutes prior to fentanyl–fluanisone)	IP, IV IM	Flecknell and Mitchell, 1984 Flecknell, 1987
Etorphine + Methotrimeprazine	0.025–0.05 ml/kg	IM	Flecknell, 1987; Flecknell et al., 1983
Diazepam + Etorphine + Methotrimeprazine	1.0 mg/kg 0.25 ml/kg	IV, IP IM	Flecknell, 1987 Flecknell et al., 1983
Other			
Alphaxalone + Alphadolone	6–20 mg/kg Optimal dose = 12 mg/kg	IV	Green, 1975 Green et al., 1978
Chloral hydrate	250 mg/kg	IV	Harvey and Walberg, 1987
Chloral hydrate + Magnesium sulfate + Pentobarbital + Propylene glycol (Equi-Thesin)	0.5–3.0 ml/kg In increments of 0.5 ml	Per rectum	Hodesson et al., 1965 Bivin and Timmons, 1974
Equi-Thesin	To effect	IV	Bivin and Timmons, 1974; Hodesson et al., 1965
Ketamine + Chloral hydrate	20 mg/kg 250 mg/kg	IM IV	Bivin and Timmons, 1974 Hobbs et al., 1991
Alpha chloralose	100 mg/kg	IV	Chakrabarty et al., 1991; Harvey and Walberg, 1987
Propofol	7.5–15 mg/kg	IV	Adam et al., 1980
Guaifenesin	5% solution in 5% dextrose, given at a dosage of 200 mg/kg	IV	Olson et al., 1987

(Continued)

TABLE 11-1

CONTINUED

Drug	Dosage	Route of administration	References
Medetomidine + Propofol	0.25–0.35 mg/kg 3–4 mg/kg	IM IV	Ko et al., 1992 Hellebrekers et al., 1997
Medetomidine + Midazolam + Propofol	0.25 mg/kg 0.5 mg/kg 2 mg/kg	IM IM IV	Ko et al., 1992
Guaifenesin + Ketamine	200 mg/kg 50 mg/kg	IV IM	Olson et al., 1987
Alpha chloralose + Urethane	32 mmol (10 g)/L In saline at dose of 258 μ mol (80 mg)/kg, 400–500 mg/kg (5.61 mmol/kg) in 1 L of saline (2.81 mol/L)	IV (slowly)	Korner et al., 1968 Warren and Ledingham, 1978
Urethane	1–1.6 g/kg 1.5 g/kg	IP IV	Bree and Cohen, 1965
Urethane + Acepromazine	1–1.30 1 mg/0.46 kg	IV IM	Moore et al., 1987
Paraldehyde	1 ml/kg	IM, IP, orally	Green, 1982a; Hodesson et al., 1965; Pandeya and Lemon, 1965
Intermittent bolus or continuous IV infusion regimens			
Sedate with Fentanyl + Droperidol	0.05 mg/kg 2.5 mg/kg	IM	Guerreiro and Page, 1987
Induce with infusion of Fentanyl + Droperidol	2.4 mg 40 mg in 100 ml of 5% dextrose, rate of 15–20 drops (volume of 17 μ l/drop)/min; maintain with 15 drops/min	IV	
Dilute Hypnorm 1:10 Midazolam + Xylazine + Alfentanil	Infuse 1–3 ml/kg/h 1 mg/kg 1 mg/kg 0.1 mg/kg	IV IV	Flecknell, 1987 Borkowski et al., 1990
Alpha chloralose + Urethane	60 mg/kg 400 mg/kg, followed by 1–3 ml 1% alpha chloralose q 30–50 minutes	IV	Jenkins, 1987
Alpha chloralose + Urethane	40–60 mg/kg 800 mg/kg, followed by 3–4 ml/h 1% alpha chloralose	IV	Dorward et al., 1987
Sedate with Ketamine + Xylazine	35 mg/kg 5 mg/kg	IM IM	Wyatt et al., 1989
Maintain with Ketamine + Xylazine	1 mg/min 0.1 mg/min	Continuous IV Infusion	Wyatt et al., 1989
Ketamine + Xylazine	25 mg/kg 5 mg/kg	IV 1/3 bolus dose over 1 minute, remainder over 4 minutes	Borkowski et al., 1990
Pentobarbital	40 mg/kg	IV, 1/3 bolus dose initially over 1 minute, remainder over 4 minutes	Borkowski et al., 1990
Propofol	Sedate with 1.5 mg/kg, maintain with 0.2–0.6 mg/kg/min “Utilization rate” of 1.55 mg/kg/min	IV bolus continuous IV infusion	Blake et al., 1988
Alphaxalone + Alphadolone	Sedate with 1 mg/kg maintain with 0.1 mg/kg/min	IV IV bolus continuous IV infusion	Glen, 1980 Blake et al., 1988

Note: GTE, given to effect.

^aModified with permission from Wixson (1994).

^bMay cause severe nephrotoxicity.

Acepromazine dosage ranging from 0.75 to 10 mg/kg IM has been recommended when used in combination with other agents (Dolowy and Hesse, 1959; Freeman et al., 1972; Lipman et al., 1990; Ludders et al., 1987; McCormick and Ashworth, 1971; Moore et al., 1987; Sedgwick, 1986). In the authors' experience, doses of 0.75–2 mg/kg are recommended when acepromazine is utilized in combination with other agents. Chlorpromazine, at doses of 25–100 mg/kg IM, reduces the amount of pentobarbital required to induce anesthesia while partially overcoming the respiratory depression caused by the barbiturate (Dolowy and Hesse, 1959). Chlorpromazine has been shown to cause severe muscle necrosis following IM injection; IV administration (7.5 mg/kg) has therefore been advocated (Bree et al., 1971). Chlorpromazine (0.1 mg/kg IV) is used in conjunction with a head-up tilt in the urethane-anesthetized rabbit to produce an orthostatic hypotension model (Kurihara et al., 2000; Takata et al., 1999). Propiopromazine with paraldehyde had been used safely as a preanesthetic agent prior to the administration of Equi-Thesin® (Hodesson et al., 1965).

The *benzodiazepine tranquilizers* (diazepam, midazolam, and zolazepam) have been used either alone or combined with other agents to produce general anesthesia. Diazepam has been used at doses of 1–2 mg/kg IM or IV (Flecknell et al., 1983). Higher doses have been cited (5–10 mg/kg IM) in the literature (Green et al., 1981). When diazepam (5 mg/kg IM) is utilized with ketamine (30 mg/kg IM), the combination produces good sedation and muscle relaxation but insufficient analgesia to carry out surgical procedures (Green et al., 1981). Midazolam, which is more potent than diazepam and is water soluble, has been successfully utilized for short-term anesthesia at 2 mg/kg intraperitoneal (IP) when combined 5 minutes later with 0.3 ml/kg IM of fentanyl/fluanisone and at 0.5 mg/kg IM combined with medetomidine (0.25 mg/kg IM) when followed in 5 minutes by propofol (2 mg/kg IV) (Flecknell and Mitchell, 1984; Ko et al., 1992). The use of midazolam (1 mg/kg) has also been reported in combination with xylazine/alfentanil (1 mg/kg; 0.1 mg/kg) for IV anesthesia in the rabbit (Borkowski et al., 1990). However, muscle rigidity often accompanied by seizures was reported with this combination. In combination with ketamine/xylazine (30 mg/kg IM; 3 mg/kg IM), midazolam (0.2 mg/kg IM) provides an adequate plane of anesthesia for 30–45 minutes, as evaluated by reflexes and an EEG spectral response to a painful stimulus; however, cardiac depression was observed and oxygen supplementation is recommended when using this combination (Dupras et al., 2001; Vachon et al., 1999). Midazolam (1 mg/kg IM) has also been administered concurrently with fentanyl/medetomidine (0.02 mg/kg IM; 0.20 mg/kg IM); however, a surgical plane of anesthesia was not achieved in all rabbits and the combination resulted in respiratory depression (Henke et al., 2005).

The α -2 *adrenergic agonists* (xylazine, medetomidine, and detomidine) have been employed alone as tranquilizers or in combination with other agents for anesthesia. The pharmacology of the α -2 adrenoceptor agonists has been reviewed (Bertolet and Hughes, 1980). Xylazine administered to rabbits

at 3–9 mg/kg IV produces sedation, excellent muscle relaxation, and, at the high dose, analgesia; however, when used alone it is not sufficient to provide surgical anesthesia and is reported to cause hyperacusia (Green, 1975). Moderate depression of cardiopulmonary parameters is observed following IM administration at 5 mg/kg (Sanford and Colby, 1980). Xylazine has been used in combination with a variety of agents, including ketamine, ketamine/acepromazine, ketamine/buprenorphine, ketamine/butorphanol, ketamine/midazolam, midazolam/alfentanil, and tiletamine/zolazepam to induce and/or maintain surgical anesthesia (Borkowski et al., 1990; Difilippo et al., 2004; Dupras et al., 2001; Green, 1975; Green et al., 1981; Henke et al., 2005; Lipman et al., 1990; Marini et al., 1992; Popilskis et al., 1991; Sanford and Colby, 1980; Sedgwick, 1986; Vachon et al., 1999). The α -2 antagonist yohimbine (0.2 mg/kg IV) was shown to effectively reverse the effects of anesthesia in ketamine/xylazine-anesthetized rabbits (Lipman et al., 1987).

Medetomidine, the most selective α -2 agonist available for use in veterinary medicine, is useful as a sedative when administered to rabbits at 0.25 mg/kg IM (Ko et al., 1992). ET intubation should not be attempted when the agent is used alone (Ko et al., 1992). Medetomidine in combination with ketamine, ketamine/diazepam, propofol, midazolam/propofol, midazolam/fentanyl, and ketamine/buprenorphine is useful for rabbit anesthesia of short-to-moderate duration (Difilippo et al., 2004; Hellebrekers et al., 1997; Henke et al., 2005; Ko et al., 1992; Mero et al., 1989; Nevalainen et al., 1989; Orr et al., 2005). Medetomidine/ketamine and medetomidine/ketamine/diazepam causes hypoxemia, necessitating supplemental oxygen administration (Hellebrekers et al., 1997; Mero et al., 1989). The addition of butorphanol to the combination prolonged the period of surgical anesthesia (Hedenqvist et al., 2002). The effects of medetomidine are successfully reversed following administration of the α -2 antagonist atipamezole at either twice the dose of medetomidine administered or 1 mg/kg IM (Kim et al., 2004; Nevalainen et al., 1989; Orr et al., 2005). Detomidine, another α -2 adrenergic agonist, has also been evaluated in rabbits (Hurley et al., 1994). Detomidine administered at 150 μ g/kg IM provided only tranquilization. When combined at 150 and 300 μ g/kg IM with ketamine and 150 μ g/kg IM with ketamine/diazepam, anesthesia was attained only with the high dose of detomidine or when diazepam was included in the regimen. Anorexia and myocardial necrosis was noted in many of the rabbits receiving the high detomidine dose. It has been concluded that the use of detomidine did not provide any advantages over other established parenteral anesthetic regimens and that detomidine should be avoided while determining the etiology of the myocardial necrosis.

3. Opioids

The use of *opioid drugs* pre- or intraoperatively may reduce or eliminate the need for postoperative analgesia. Experimental evidence in rodents, as well as clinical experience in humans

and animals, indicates that opioids used preoperatively may block afferent impulses from arriving within the CNS, preventing sensitization to pain that may develop from CNS nociceptive stimulation (Melzack et al., 2001). Their administration has been shown to reduce postoperative pain and analgesic requirements (Melzack et al., 2001). Classically, narcotic analgesics have been employed alone for pre- and intraoperative analgesia or with sedatives for chemical restraint preoperatively. A more detailed discussion of opioid analgesics is provided later in the chapter.

4. Antimicrobials

Parenteral *antimicrobial administration* may be useful for specific surgical procedures, for example surgical manipulation of the bowel. Antimicrobials should be administered pre- or intraoperatively so that sufficient levels are present in blood and/or tissue at the time of the expected insult. Particular antibiotics such as amoxicillin, ampicillin, cephalothin, clindamycin, and lincomycin may precipitate potentially fatal clostridial enterotoxemias (Carman and Evans, 1984). Postoperative administration of cholestyramine may be useful in reducing mortality associated with antibiotic administration (Lipman et al., 1992). Certain antibiotics may also interact adversely with paralytics and/or inhalational agents.

5. Vitamin C

Premedication of rabbits with vitamin C (240 mg/kg) intramuscularly, 5 minutes prior to administration of ketamine (40 mg/kg IM), resulted in a reduction in anesthesia onset, prolongation of anesthetic duration, as well as bradycardia and hyperglycemia (Elsa and Ubandawaki, 2005). Sleep time and blood glucose concentration were increased by 18 and 212%, and anesthesia onset and heart rate were reduced by 67 and 33%, respectively. Premedication with high-dose vitamin C also precluded ketamine-induced reduction of serum calcium and phosphorus. These findings were the result of the depressant effects of vitamin C on central nervous system function. The findings of this single report should be confirmed by another laboratory before ascorbic acid is employed as a preanesthetic in rabbits.

III. METHODS OF DELIVERY/ADMINISTRATION

A. Injection Sites

The IM site is commonly used for the administration of a variety of parenteral agents used for tranquilization and anesthesia. As in other species, injections should be made into the body of large muscles, avoiding vessels and nerves. IM injections can be made into either the anterior or posterior aspect of the thigh or the lumbar epaxial musculature. Hodesson et al. (1965) recommend administering drugs into the vastus lateralis

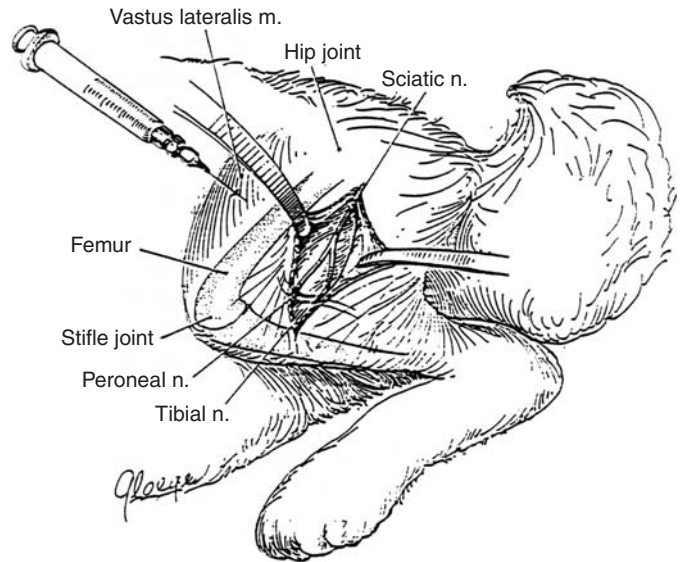

Fig. 11-1 Sketch depicting major nerves and blood vessels of thigh. Reprinted with permission from Hodesson et al. (1965).

and rectus femoris muscles of the anterior thigh at right angles to the femur (Fig. 11-1). Injections into the caudal thigh, specifically the biceps femoris, semimembranosus, semitendinosus, and the adductor magnus, can be performed safely if the needle is directed away from the sciatic nerve and its branches. The needle should be inserted into the lateral aspect of the thigh at right angles to the femur or directed caudally away from the femur. Despite appropriate technique, some drugs, notably chlorpromazine and ketamine/xylazine, have been associated with pathology following IM administration (Beyers et al., 1991; Bree et al., 1971). Myonecrosis, vasculitis, and axonal degeneration with attendant self-trauma and amputation have been reported. Injection volumes should be limited to less than 1.5 and 1.0 ml IM, respectively, for adult New Zealand white and Dutch belted rabbits.

Subcutaneous administration of anesthetics, although uncommon, may be useful with particular agents such as ketamine and medetomidine (Hedenqvist et al., 2002; Mero et al., 1989; Orr et al., 2005). Postoperative fluid administration by the SC route is routine. The cervical region should be avoided, as rabbits are routinely handled by the scruff of the neck. Substances that are irritating should be avoided or diluted prior to SC injection.

Vascular access for IV administration of drugs is readily attainable. The lateral (marginal) auricular veins are preferred and easily accessed. Injection and catheterization techniques have been described that can also be used for constant IV or intermittent bolus infusion techniques (Green, 1982b; Grice, 1964; Melich, 1990; Paulsen and Valentine, 1984). The cephalic and recurrent tarsal veins can also be utilized (Gardner, 1964; Green, 1982b). An intravascular catheter can be attached to a vascular access port that is taped to the animal's pinnae

or implanted subcutaneously when repetitive vascular access is required (Melich, 1990; Perry-Clark and Meunier, 1991; Swindle et al., 2005). The volume and rate of IV infusion must be monitored in order to prevent volume overload, which may lead to pulmonary edema. Air bubbles should be voided from the material to be administered to prevent air emboli. The application of lidocaine–prilocaine cream to the ear before venipuncture has been recommended to reduce pain, especially when training inexperienced staff (Flecknell et al., 1990). The central auricular artery is easily cannulated for arterial blood sampling for blood gas determination and is routinely used for collection of large volumes of blood (Fick and Schalm, 1986; Ludders et al., 1987; Marini et al., 1992; Smith et al., 1988; Stickrod et al., 1981). Drugs with vasodilatory action, such as acepromazine or droperidol, can be administered to aid in blood collection. Vasospasm can be prevented by applying 2% nitroglycerin ointment to the artery (Smith et al., 1988). Adequate postphlebotomy hemostasis is critical, especially following arterial puncture.

Intraperitoneal administration of anesthetics is primarily of historical interest. Although IP injections can be performed safely, the risk of puncturing a hollow viscus, the difficulty of restraint for injections, the possibility of irritation, and inconsistent absorption limit their consideration in light of alternatives.

Techniques have been described for the *intrathecal* administration of local anesthetics for spinal anesthesia in the rabbit. Techniques for both single injection and chronic administration through a surgically implanted cannula have been described (Adams et al., 1974; Bieter et al., 1936; Hughes et al., 1993; Kero et al., 1981; Langerman et al., 1990; Malinovsky et al., 1997). Spinal anesthesia has been recommended for studies on the fetus in which depressant anesthetic effects are to be avoided (Kero et al., 1981).

B. Intranasal Administration

A variety of anesthetics or anesthetic combinations (ketamine, midazolam, tiletamine/zolazepam, ketamine/xylazine, ketamine/midazolam, and fentanyl/droperidol) have been administered via the intranasal route to rabbits (Robertson and Eberhart, 1994). Equal volumes of anesthetic were administered into each nare using a catheter-tipped syringe after the agents were diluted with sterile saline and administered at a dose of 0.4 ml/kg. No single anesthetic or anesthetic combination consistently provided a surgical plane of anesthesia; however, midazolam provided good sedation and muscle relaxation.

C. Tracheal Access

The anatomy of the rabbit's oropharynx makes ET intubation more difficult than in most other species. The epiglottis and



Fig. 11-2 Dorsal view of the tongue, larynx, and proximal trachea from an adult New Zealand white rabbit. Note the long tongue and notched U-shaped epiglottis.

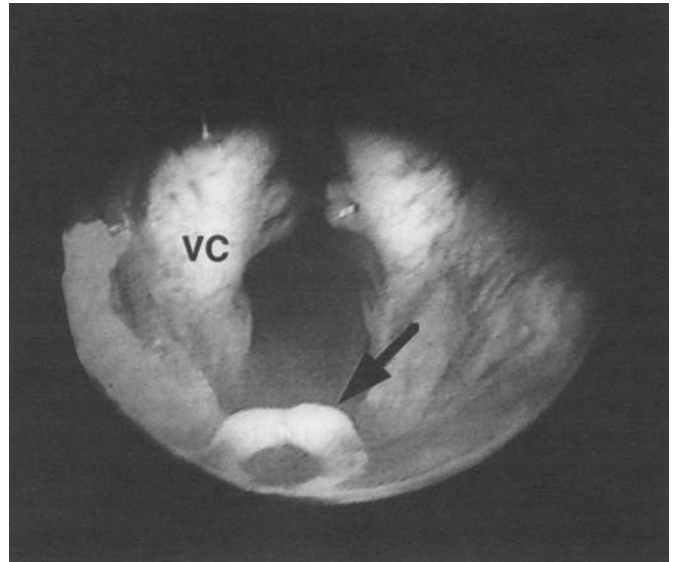

Fig. 11-3 View of laryngeal structures in an anesthetized rabbit utilizing a 3.5 mm fiberoptic bronchoscope. The tip of the bronchoscope is depressing the epiglottis. The *hamuli epiglottici* are visible (arrow) as are the vocal cords (VC). Photograph courtesy of P. Padrid.

larynx are difficult to visualize because of the large incisors, the long and narrow oral cavity, a thick tongue, and the limited mobility of the temporo-mandibular joint (Fig. 11-2). Laryngospasm is also induced easily (Wixson, 1994). The epiglottis is large, U-shaped, soft, and flexible. Just beyond the base of the epiglottis is a deep sagittal niche, bordered on both sagittal recesses by the *hamuli epiglottici* (Fig. 11-3). This structure lifts the local epithelial layer and can be damaged easily by rough or incorrect ET intubation (Schuyt and Leene, 1977). The diameter of the *aditus laryngicus* is smaller than the diameter of the

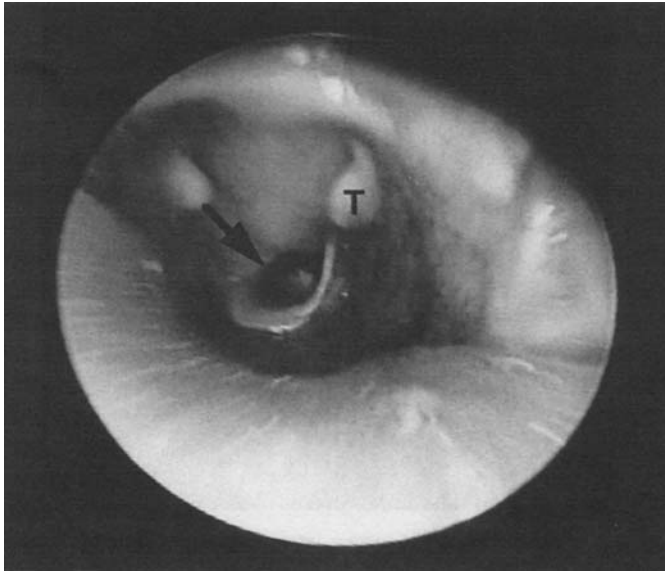

Fig. 11-4 View of the oropharynx and larynx in an anesthetized rabbit utilizing a 3.5 mm fiberoptic bronchoscope. The laryngoscope blade is visible in the foreground. Note the tonsils (T) and the aditus laryngicus (arrow).

tracheal lumen and dictates the size of the ET tube (Fig. 11-4) (Schuyt et al., 1978). The vocal cords are situated extremely craniad and run obliquely in a dorsal–ventral direction (Schuyt and Leene, 1977).

There are numerous descriptions of techniques and devices which are useful in ET tube placement (Alexander and Clark, 1980; Bertolet and Hughes, 1980; Davis and Malinin, 1974; Fick and Schalm, 1987; Gografe et al., 2003; Hoge et al., 1969; Howard et al., 1990; Kumar et al., 1993; Lindquist, 1972; Macrae and Guerreiro, 1989; Schuyt and Leene, 1977; Schuyt et al., 1978; Smith et al., 2004; Tran et al., 2001; Worthley et al., 2000). Parenteral or volatile anesthetics are administered prior to intubation. ET intubation can be performed with or without direct visualization of the larynx in the prone or supine position. For successful intubation, the mouth, larynx, and trachea must be brought into linear alignment. In an outstretched prone position, the rabbit's head is tipped and the neck is extended until the head is upright at a right angle to the rest of its body (Alexander and Clark, 1980). If intubated in the supine position, the neck is hyperextended by placing a rolled towel under the cervical region (Schuyt and Leene, 1977) or by fashioning a holder from styrofoam (Davis and Malinin, 1974).

Uncuffed (Cole or straight) or cuffed ET tubes (2.0–4.0 mm diameter) are used with or without an intubation stylet (Fig. 11-5). Smith et al. (2004) reported easier intubation using a cuffed tube. However, slightly greater waste anesthetic gas (WAG) was emitted from the rabbit's labial commissure, although none was detected at the operator's breathing zone. Wire-reinforced ET tubes should be used for procedures where kinking the tube is possible, such as stereotaxic surgery. A pediatric laryngoscope (size 0–1 Wisconsin or neonatal or size no. 1

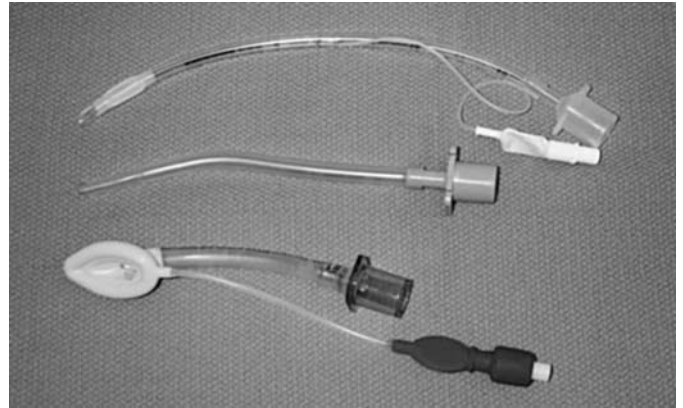

Fig. 11-5 Devices used to deliver inhalational anesthetics to rabbits. From top to bottom: cuffed endotracheal tube (Murphy eye type), uncuffed endotracheal tube (Cole type), and laryngeal mask airway. Reprinted with permission from Smith et al. (2004).

Miller blade) may be used, depending on the size of the rabbit (Lindquist, 1972; Macrae and Guerreiro, 1989). A handheld otoscope with a 5 mm ear speculum can be utilized to visualize the larynx and intubate small (~1.3 kg) rabbits (Weinstein et al., 2000). The larynx may be sprayed with a topical anesthetic (without epinephrine) or anesthetic lubricant applied to the tube to reduce laryngeal irritability. Extreme caution should be used when spraying the larynx with any of the topical anesthetics, as overdosage is possible. Benzocaine-topical anesthetic spray has been shown to cause methemoglobinemia, which may confound experimental results, in rabbits following a second application (Davis et al., 1993). Following visualization of the larynx, the tube is inserted gently on inspiration so that it passes through the *aditus laryngicus* when the vocal cords are abducted. If placement of the ET tube in the supraglottic region severely limits vision, the ET tube can be placed over a 0.97 mm flexible guide wire or a 5 or 6 Fr nylon IV or polypropylene urinary catheter (Gografe et al., 2003; Macrae and Guerreiro, 1989; Weinstein et al., 2000). The guide wire or catheter can be advanced into the larynx under direct visualization before advancing the tube over the device. Intubation can also be aided using a rigid 30° endoscope passed through a 4.5 mm ET tube (Tran et al., 2001). This method allows direct visualization as the tube is advanced. Similarly, Worthley et al. (2000) used a 10 mm fiber optic to visualize the larynx before passing an ET tube.

When intubation is performed blindly, the tube is placed in the supraglottic region and inserted into the larynx during inspiration, with the operator observing respiratory pattern and rate or tube condensation, or listening for breath sounds with or without a respiratory monitor to coordinate the advancement (Hoge et al., 1969; Howard et al., 1990). Proper placement of the tube can be verified, as in other species, by palpation of the trachea and esophagus, listening for respiratory sounds, or observing air flow at the distal end of the tube by looking for displacement of plucked fur or condensation on a dental mirror. Intubation

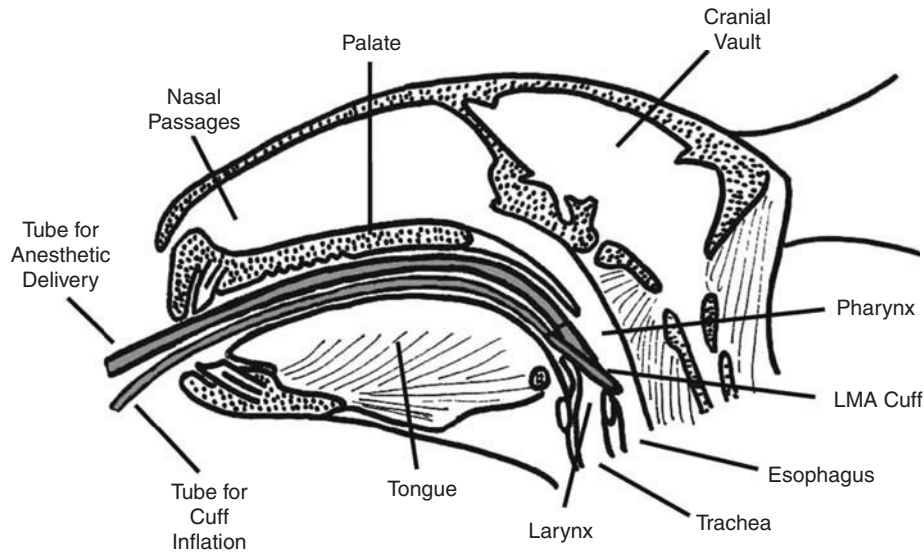

Fig. 11-6 Diagram showing proper placement of a laryngeal mask airway with respect to the oropharyngeal cavity and upper airway of the rabbit. Reprinted with permission from Smith et al. (2004).

has also been accomplished by inserting a 19 gauge, 20 cm catheter percutaneously through a guide needle into the trachea of an anesthetized rabbit, advancing the catheter retrograde through the larynx into the mouth, and finally, advancing the ET tube over the catheter, which serves as a guide (Bertolet and Hughes, 1980). Alternatively, a needle cricothyroidotomy can be performed, followed by cannulation with a guide wire, vessel dilator, and sheath introducer with sideport extension (Irazuzta et al., 1997). ET tubes should be fixed in place with gauze or tape to avoid accidental extubation and should be routinely suctioned during procedures of modest or prolonged duration, as respiratory secretions may occlude the lumen.

Tracheal mucosal injury may be a sequela to intubation in the rabbit (Grint et al., 2005; Nordin et al., 1977; Phaneuf et al., 2006; Squire et al., 1990). The pressure of the inflated cuff against the epithelium has been reported to interfere with blood flow and possibly cause necrosis (Nordin et al., 1977). Phaneuf et al. (2006) described sublaryngeal tracheal injury and ulceration in 15 rabbits from several institutions intubated with both cuffed and uncuffed ET tubes. They eliminated both cuff pressure and prolonged intubation times as the etiology and speculated that the rabbit's tracheal vascular anatomy, the subtle movement of the tube during mechanical ventilation, positioning, and repeated intubation may have resulted in tracheal mucosal injury. Postintubation tracheal strictures have been described in rabbits 2–3 weeks after anesthesia (Grint et al., 2005). Although the definitive cause of the tracheal injury was unconfirmed, the location of the injury (adjacent to the tube's bevel) led the authors to speculate that the cause was either trauma or chemical injury from agents used to disinfect the ET tubes.

Because of the difficulties with intubation and its potential complications, alternatives to ET tube placement have been

sought. Tracheostomies may be appropriate for nonsurvival surgical preparations requiring tracheal access. They are not generally recommended for survival surgical procedures because of postoperative considerations. Administration of inhalational agents by mask has been described for both induction and/or maintenance of anesthesia (Bateman et al., 2005; Betteridge, 1973; Flecknell et al., 1996, 1999; Hedenqvist et al., 2001; Kent, 1971; Sherrard, 1966). Induction by this method should be avoided, unless injectable premedicant use is restricted by experimental protocol, as significant behavioral and adverse physiologic effects, including severe apnea, hypercapnia, and hypoxemia, have been reported with desflurane, isoflurane, and sevoflurane (Bateman et al., 2005; Flecknell et al., 1996, 1999; Hedenqvist et al., 2001). Given the need, rapid induction with desflurane is preferred to slowly increasing concentrations of desflurane, isoflurane, or sevoflurane (Flecknell et al., 1999; Hedenqvist et al., 2001). Similar problems have been observed when using an anesthetic chamber for induction (Flecknell et al., 1996). While maintaining gas anesthesia by mask is not fraught with the same issues as induction, the increased risk of operator exposure to WAG, the inability to administer controlled or assisted ventilation, the possibility of airway obstruction, and the considerable dead space provided by the mask must all be considered (Bateman et al., 2005). Rabbits should be premedicated with sedatives if mask or chamber induction is used. Modified cat restraint bags have been used to mask induce previously sedated animals (Lindquist, 1972).

Recent reports describe the use of a laryngeal mask airway (LMA) [size 1] in lieu of ET tube placement (Bateman et al., 2005; Smith et al., 2004) for provision of inhalants. An LMA consists of an airway tube, a mask with an inflatable cuff, and a mask-inflation line (Fig. 11-5). The mask is designed to sit over and surround the larynx (Fig. 11-6). Smith et al.

(2004) described placing an LMA with the rabbit in right lateral recumbency and the animal's head and neck tilted upward at a 90° angle. The device is inserted with its aperture turned toward the tongue and its convex side against the left buccal wall blindly until it reaches the desired position. The device is then rotated 90° counterclockwise so that the margins of the LMA's cuff cover the edges of the laryngeal aperture and the cuff is inflated to reduce WAG escape and allow for positive pressure ventilation. The authors report that the LMA was easier to place than an ET tube, especially among staff with limited experience; however, the LMA emitted greater WAG. Bateman et al. (2005) reported a similar experience using an LMA, except they did not inflate the cuff and observed gastric tympany in ventilated animals. Imai et al. (2005) developed a device with features similar to an LMA, consisting of a spiral wire-containing tube, a mask designed to surround and seal the larynx, and an inflatable balloon designed to lie in the proximal esophagus. The device is inserted blindly, with the rabbit positioned in lateral recumbency with its neck in ventriflextion; the device allowed for intermittent positive pressure ventilation (IPPV).

The authors' recommended regimen for intubation of the rabbit is ketamine (35 mg/kg IM) and xylazine (5 mg/kg IM). Isoflurane, methohexital, Saffan, thiamylal, thiopentone, pentobarbital, propofol, medetomidine/propofol, medetomidine/ketamine, medetomidine/xylazine/propofol, medetomidine/fentanyl/midazolam, ketamine/xylazine/acepromazine, and propanidid have also been used for anesthetic induction prior to ET intubation in the rabbit (Green, 1982b; Hellebrekers et al., 1997; Henke et al., 1996, 2005; Ko et al., 1992; Orr et al., 2005; Tran et al., 2001; Weinstein et al., 2000).

IV. PARENTERAL TECHNIQUES

For practical purposes, anesthetics used in the rabbit can be divided into the broad categories of injectable and inhalational agents. Injectable techniques have a long history of use in the rabbit. Ease of administration, predictability, reasonable efficacy, and avoidance of the technical demands of administering inhalants are features that have popularized the use of these agents in the rabbit. At the same time however, untoward physiologic effects, inability to control anesthetic depth, and prolonged recovery attendant with their use have prompted the search for newer agents or novel combinations of agents. Many injectable agents and combinations produce physiologic trespass sufficient to produce hypoxemia and should therefore be used with oxygen supplementation. The literature abounds with descriptions of the use of various injectables; some are of historical interest, others are of limited availability, and still others have become valuable agents in the anesthetist's armamentarium. Recently, a number of these agents have been evaluated for their influence on plasma analytes; therefore, careful consideration must be given to interpreting biochemical results from anesthetized rabbits or those

in the immediate postanesthetic recovery period (Gonzalez-Gil et al., 2002, 2003, 2005; Gil et al., 2004; Illera et al., 2000). In this section, injectable agents will be discussed based upon functional or chemical similarities.

A. Barbiturates

The oxybarbiturate agent pentobarbital has been alternately lauded (Conn and Langer, 1978; Jacobs and Krohn, 1975; Koch and Dwyer, 1988; Marston et al., 1965; Zhou et al., 1981) and disparaged (Borkowski et al., 1990; Flecknell et al., 1983; Green, 1975; Peeters et al., 1988) as an anesthetic agent in the rabbit. It is now widely held that the dose at which surgical anesthesia occurs is extremely close to the dose at which apnea occurs. This apnea may be reversed by utilizing the Hering-Breuer reflex, the activation of stretch receptors in the lungs in response to overinflation. Most commonly, chest compression can be provided by manual compression or by placement of an elastic band around the thorax. Anecdotally, success in the use of this agent requires considerable finesse. While pentobarbital is customarily given intravenously, the IM (Krogh, 1975) and intrahepatic routes of administration have also been reported (Jacobs and Krohn, 1975). These latter routes are discouraged because of variability in effect, the potential for tissue irritation, and the ease of IV administration in the rabbit. Dosages range from 25 to 60 mg/kg IV. A typical schedule of administration is to inject some fraction of the calculated dose (generally one-third) over a specified time period, followed by slow infusion of the remainder. Incremental dosages of 3–5 mg/kg IV can be used to prolong anesthesia (Green, 1982b). Pentobarbital may be diluted with saline to enhance the precision of dose administration and, consequently, its safety (Booth and McDonald, 1988). Continuous IV infusions of 7.5 and 20 mg/kg/h after an initial pentobarbital bolus of 50 mg/kg have also been reported (Todd et al., 1994).

The hallmark physiologic effect of pentobarbital is respiratory depression. A number of studies using a variety of doses and infusion schedules describe severe respiratory depression or arrest (Borkowski et al., 1990; Flecknell et al., 1983; Peeters et al., 1988). Respiratory acidosis, hypoxemia, hypercarbia, and depression of respiratory rate are all characteristic features of this drug (Borkowski et al., 1990; Flecknell et al., 1983). In contrast, several studies have demonstrated minimal blood gas alterations when using pentobarbital at doses that did not eliminate the pedal reflex (Korner et al., 1968; Morita et al., 1987). The additional dosage required to eliminate response to noxious stimuli may induce prolonged apnea.

The features of pentobarbital's effects on the cardiovascular system include preservation of (Borkowski et al., 1990) or increased heart rate (Korner et al., 1968; Morita et al., 1987), decreased arterial blood pressure (Borkowski et al., 1990; Korner et al., 1968; Morita et al., 1987), peripheral vasodilation (Korner et al., 1968; Morita et al., 1987), decreased

cardiac output (Korner et al., 1968), and depression of the vasoconstrictor response to hemorrhage (Warren and Ledingham, 1978). The gain of the baroreflex system (the ability of the system to sustain arterial pressure in the face of hemorrhage) is depressed in a time-dependent fashion, with complete recovery of the system to preanesthetic levels 70 minutes after the administration of 25 mg/kg pentobarbital (Katsuda et al., 2000). Pentobarbital maintained cardiovascular parameters better than either ketamine/xylazine or midazolam/xylazine/alfentanil in one study (Borkowski et al., 1990). The tachycardia of pentobarbital anesthesia has been shown to be attributable to baroreflex compensation (Morita et al., 1987).

Pentobarbital has been used in combination with a variety of agents to reduce the dosage required for anesthesia, improve safety, and enhance efficacy (Dolowy and Hesse, 1959; Green, 1975, 1982b; Hobbs et al., 1991; Krogh, 1975; Olson et al., 1987; Schutten and Van Horn, 1977). The following combinations have been used:

- Ketamine (50 mg/kg) and pentobarbital (30 mg/kg) administered in separate syringes intramuscularly, were reported to cause deep anesthesia of 60–80 minutes duration (Krogh, 1975).
- Chlorpromazine premedication (2 mg/kg IM) followed by pentobarbital (20–30 mg/kg IV) has been reported to be a safe anesthetic combination for the rabbit (Green, 1975).
- A range of chlorpromazine doses (25–100 mg/kg IM) was used prior to pentobarbital (20 mg/kg IV) to produce anesthesia but pedal “withdrawal reflexes were often present” (Dolowy and Hesse, 1959).
- Five percent guaifenesin in 5% dextrose (200 mg/kg IV) was followed by 20 mg/kg pentobarbital (20 mg/kg IV) to produce anesthesia in six rabbits (Olson et al., 1987). Tachycardia with reductions in respiratory rate and mean arterial blood pressure characterized this combination; pedal reflex returned in all rabbits by 30 minutes after drug administration (Olson et al., 1987).
- Xylazine (5 mg/kg SC) followed in 10 minutes by 11.8–28.4 mg/kg pentobarbital IV produced 37.5 minutes of anesthesia although one of eight rabbits died (Hobbs et al., 1991).

Pentobarbital has been used in the rabbit as a component of Equi-Thesin (Hodesson et al., 1965). Rabbits were premedicated with paraldehyde (0.3 ml/kg IM) and diazepam (7.5 mg/kg IM) and then administered varying doses of Equi-Thesin intrarectally (1–3 ml/kg). Results were variable with regard to safety and the depth and duration of anesthesia produced. Equi-Thesin was also administered intravenously to effect after paraldehyde (0.3 ml/kg) and diazepam (10 mg/kg IM). Effective dosages of Equi-Thesin ranged from 0.83 to 2.35 ml/kg; anesthesia of varying durations was achieved in 10 of 11 rabbits with one fatality. Similar results were attained with Equi-Thesin used after premedication with propiopromazine (5 mg/kg IM) and paraldehyde (0.3 ml/kg IM). Equi-Thesin is no longer commercially

available but can be prepared by combining pentobarbital, magnesium sulfate, and chloral hydrate.

Several miscellaneous features of pentobarbital anesthesia deserve mention. When pentobarbital was used in a coronary artery ligation study, less myocardial damage was observed when compared to either halothane or alpha chloralose (Chakrabarty et al., 1991), underscoring the impact of choice of anesthetic on research results. Pentobarbital caused reductions in plasma potassium concentrations that were associated with increases in plasma renin activity and aldosterone concentration (Robson et al., 1981). Pentobarbital appears to exhibit tolerance (tachyphylaxis) in the rabbit; equivalent anesthetic effects required doubling the pentobarbital doses when attempts were made to anesthetize animals more than once weekly (Pandeya and Lemon, 1965). Finally, opioids appear to modify the duration of action of pentobarbital by a central cholinergic mechanism (Horita and Carino, 1978; Horita et al., 1983).

Other barbiturates that have been used in the rabbit include the thiobarbiturates thiamylal, thiopental, ethyl-malonyl-thiourea (EMTU), and the methylated oxybarbiturate, methohexital (Gardner, 1964; Green, 1982b; Hobbs et al., 1991; Holland, 1973; Lockhart et al., 1991; MacLeod, 1977; Murdock, 1969; Mustola et al., 2000; Sedgwick, 1986; Stunkard and Miller, 1974). These are outlined below.

- Dosages reported for thiamylal are 31 mg/kg of a 1% solution, 29 mg/kg of a 2% solution (Gardner, 1964), and 15 mg/kg IV (Sedgwick, 1986). Thiopentone dosages recommended in the literature include 30 mg/kg (one-half given rapidly IV with the rest administered slowly over 60 seconds) (Green, 1982b), 6 mg/kg slowly IV to effect prior to ET intubation (Green, 1982b), 15 mg/kg (Sedgwick, 1986), 50 mg/kg of a 1.25% solution (Holland, 1973), and 50 mg/kg of a 2.5% solution (Lumb and Jones, 1984). A constant rate infusion of thiopentone (30 ml/h of a 25 g/ml solution IV) achieved loss of righting reflex and ablation of reaction to tail clamping (spinally processed stimulus) or intranasal administration of ammonia vapor (centrally processed stimulus). One-third of rabbits developed cyanosis during the tail-clamping trial but respiratory arrest did not occur (Mustola et al., 2000). These dosages vary widely and may be influenced by other factors such as breed or conditioning. Whatever dose is chosen, safety is enhanced by using the more dilute solutions and injecting agents slowly to effect. The duration of action for these agents is usually 5–10 minutes (Murdock, 1969).
- The use of EMTU has been reported in conjunction with xylazine or ketamine (Hobbs et al., 1991). Xylazine (5 mg/kg SC) or ketamine (35 mg/kg IM) was followed in 10 minutes by EMTU administered intravenously to effect (12.5–47.6 mg/kg following xylazine; 25–54 mg/kg following ketamine). The combinations caused 34 and 19 minutes of anesthesia, respectively. Anesthesia was

not consistently induced with ketamine-EMTU while xylazine-EMTU provided "the most consistent and safest anesthetic episode" of those tested (Hobbs et al., 1991).

- Methohexitone has been recommended for use as an induction agent prior to ET intubation (10 mg/kg of a 1% solution rapidly IV) (Green, 1982b). Two to 5 minutes of light anesthesia are provided; increments of 4–6 mg/kg IV may prolong anesthesia for short procedures. Methohexital (5 mg/kg) administered IV has also been recommended for use in the rabbit (Antal, 1985).

B. Dissociatives

The dissociative agent that has been used most widely in rabbit anesthesia is ketamine. It is typically administered in combination with other agents as it does not provide adequate muscle relaxation or analgesia for surgical anesthesia when used alone (Green, 1982b; Green et al., 1981; White and Holmes, 1976). As a sole agent, ketamine should be restricted to minimally invasive procedures; both the IM and IV routes have been used. Constant-rate IV infusion of ketamine (30 ml/h of a 20 mg/ml concentration) effected loss of righting reflex, and loss of reaction to tail clamping and ammonia vapor inhalation (Mustola et al., 2000). The relative potency and plasma concentrations of ketamine with regard to these endpoints and in comparison to propofol and thiopentone were also reported (see below). Intramuscular doses ranging from 20 to 60 mg/kg have been reported (Green, 1975, 1982b) although doses greater than 50 mg/kg probably provide little additional restraint. ET intubation has been reported with ketamine alone (15–20 mg/kg); 10% ketamine diluted 1:2 with saline and injected at a rate of 100 mg in 10–15 seconds was used for this purpose (Lindquist, 1972). The combination ketamine/xylazine is preferred for intubation.

The agent most commonly used in combination with ketamine is the α -2 agonist xylazine. Ketamine/xylazine doses ranging from 22 mg/kg ketamine and 2.5 mg/kg xylazine to 50 mg/kg ketamine and 10 mg/kg xylazine have been reported (Beyers et al., 1991; Rich et al., 1990; White and Holmes, 1976). The dose that appears most frequently in the literature is 35 mg/kg ketamine and 5 mg/kg xylazine. The combination at this dose provided mean withdrawal reflex loss durations of 46.5 (Hobbs et al., 1991), 32 (Marini et al., 1992), and 57 minutes (Lipman et al., 1990), respectively. Considerable variation in the response to ketamine/xylazine exists among rabbits (Marini et al., 1992; Peeters et al., 1988). Incremental doses of one-third the original dose IM can be used to prolong anesthesia. The combination of ketamine (50 mg/kg) and xylazine (10 mg/kg) provides generally effective anesthesia for procedures of moderate surgical stimulus intensity (e.g., carotid endarterectomy and subcutaneous implantation). More intense surgical stimuli associated with intraabdominal and intrathoracic procedures are accompanied by undesirable muscle fasciculation and autonomic response (e.g., increased heart rate, arterial blood pressure, and

respiratory rate). There may be breed, gender, or other influences in the anesthetic efficacy of this combination (Avsaroglu et al., 2003), as 50 mg/kg ketamine and 4 mg/kg xylazine produced an adequate anesthetic plane in only 7 of 19 chinchilla rabbits in one study (Henke et al., 2005).

A myriad of physiologic effects occurs with intramuscularly administered ketamine/xylazine. Depression of respiratory rate ranging from 40 to 77% of preanesthetic baseline values has been reported (Hobbs et al., 1991; Lipman et al., 1990; Marini et al., 1992; Peeters et al., 1988; Popilskis et al., 1991; Sanford and Colby, 1980; Wyatt et al., 1989). Associated blood gas changes included hypoxemia (43–50% reduction) and CO₂ retention (25–50% increase) (Marini et al., 1992; Peeters et al., 1988; Popilskis et al., 1991; Wyatt et al., 1989). Arterial blood pH either remained unchanged (Marini et al., 1992; Popilskis et al., 1991; Wyatt et al., 1989) or increased marginally due to metabolic alkalosis with partial respiratory compensation (Peeters et al., 1988). Cardiovascular changes were manifest as decreases in heart rate (from insignificant change to 35% reduction) and hypotension (20–35% reduction). The maximal alterations produced by the ketamine/xylazine combination paralleled those seen when either drug was administered alone; ketamine preservation of heart rate was the only exception (Sanford and Colby, 1980).

Authors' Preference

Agent	Ketamine/xylazine
Route	IM injection
Dose	Ketamine 35–50 mg/kg; xylazine 5–10 mg/kg
Comments	Perineural injection may lead to self-trauma; adequate for arterial cutdowns and other somatic procedures. Consistency may be improved and depth enhanced by the addition of butorphanol (0.1 mg/kg IM) or acepromazine (0.75 mg/kg IM). Incremental doses of one-third the original dose of ketamine/xylazine may be used to prolong anesthesia.

Several investigators have described the IV use of ketamine, either alone or in combination with xylazine (Borkowski et al., 1990; Dhasmana et al., 1984; Lindquist, 1972; McGrath et al., 1975; Wyatt et al., 1989). Borkowski evaluated ketamine (25 mg/kg) and xylazine (5 mg/kg); the agents were mixed in the same syringe (1:1 v:v) and one-third the calculated dose was administered into the marginal ear vein over 1 minute. The remainder was administered over the next 4 minutes. The physiologic changes measured were similar to those described previously for IM administration of this combination with the exception that apnea occurred in two of seven rabbits. In another study, a single IM dose of ketamine (35 mg/kg) and xylazine (5 mg/kg) was followed with a 4-hour, constant-rate IV infusion of the same agents at dose levels of 1 mg/min ketamine and 0.1 mg/min xylazine (Wyatt et al., 1989). Blood pressure progressively declined throughout the duration of this regimen from an initial reduction of 21% from baseline to a reduction of 49%. Arterial O₂ tension initially declined to 45% of baseline

but increased progressively as the infusion continued. It was concluded that the regimen was a safe and effective method of producing light anesthesia in the rabbit, except that hypotension and hypoxemia might be unacceptable experimental variables. In the Dutch belted rabbit, repeated use of IM ketamine/xylazine followed by constant-rate infusions of this combination has been associated with myocardial fibrosis (Marini et al., 1999).

Medetomidine/ketamine combinations have been more widely investigated since the first edition of this text (Difilippo et al., 2004; Hedenqvist et al., 2001; Hellebrekers et al., 1997; Henke et al., 2005; Nevalainen et al., 1989; Orr et al., 2005). Reported doses vary from 15 to 35 mg/kg for ketamine and 0.25–0.5 mg/kg for medetomidine. Physiologic effects of these regimens are similar to those reported for ketamine/xylazine, but arterial blood pressure is better preserved in most studies. As in other species however, cardiac output is likely to be depressed by α -2 agonists, and inadequate tissue perfusion may still occur. Henke et al. (2005) determined that medetomidine (0.25 mg/kg IM) and ketamine (35.0 mg/kg IM) were superior to xylazine/ketamine and medetomidine/fentanyl/midazolam from the perspective of quality and prevalence of surgical anesthesia in chinchilla rabbits. Difilippo et al. (2004) compared medetomidine (0.5 mg/kg IM), ketamine (35 mg/kg IM), and buprenorphine (0.03 mg/kg IM) with an equivalent regimen substituting xylazine (5 mg/kg IM) for medetomidine. Rabbits were intubated and administered 0.75% isoflurane. They found that the medetomidine combination was safe and effective, and preserved mean, systolic, and diastolic blood pressure to a significantly greater degree than xylazine. The α -2 agonists were not reversed in this study; the medetomidine group had significantly longer reflex recovery times. Medetomidine (0.25 or 0.5 mg/kg IM or SC) and ketamine (15 mg IM or SC) were used for gonadectomy in 105 domestic pet rabbits of various breeds, ages, and both genders (Orr et al., 2005). All rabbits were intubated and administered 100% oxygen; isoflurane was administered as needed to maintain an adequate anesthetic plane. Fewer rabbits required isoflurane with the higher medetomidine dose; both routes were efficacious but anesthetic induction was slower when the agents were administered SC. Righting reflex returned more quickly with the lower dose. Female rabbits more frequently required isoflurane, presumably due to the more invasive nature of the surgical procedure, and also maintained higher respiratory rates and lower mean and highest expired CO₂ concentration (F_ECO₂) during anesthesia. Because of the variable health status and breed differences likely encountered in a diverse pet population, the authors recommended lower dose medetomidine/ketamine administered SC along with using isoflurane supplementation as needed as the regimen of choice. Medetomidine reversal was achieved using atipamezole administered intravenously at twice the former drug's dose. In rabbits anesthetized with medetomidine (0.35 mg/kg IV) and ketamine (5 mg/kg IV), atipamezole administered at doses equivalent to or twice that of medetomidine rapidly reversed medetomidine-associated depression

of heart rate, mean arterial pressure and respiratory rate. At a medetomidine equivalent dose, atipamezole reduced mean arousal time from 40.5 ± 15 minutes to 1.5 ± 1 minute (Kim et al., 2004). While IV administration of atipamezole has been safely used in the rabbit, the IM route was preferred for routine use.

Other ketamine combinations that have been reported include ketamine/pentobarbital (Krogh, 1975; Schutten and Van Horn, 1977), ketamine/EMTU (Hobbs et al., 1991), ketamine/guaifenesin (Olson et al., 1987), ketamine/chloral hydrate (Chen and Bohner, 1968; Hobbs et al., 1991), ketamine/xylazine/acepromazine (Lipman et al., 1990), ketamine/detomidine (Hurley et al., 1994), ketamine/diazepam (Green, 1982b; Sedgwick, 1986), ketamine/detomidine/diazepam (Hurley et al., 1994), and ketamine/xylazine/butorphanol (Marini et al., 1992).

Ketamine/xylazine/acepromazine increased the duration of anesthesia (as measured by absence of pedal reflex) when compared to ketamine/xylazine but did so at the expense of moderate increases in degree of hypotension and hypothermia. Reported doses include ketamine (35 mg/kg), xylazine (5 mg/kg), acepromazine (0.75 mg/kg) and ketamine (40 mg/kg), xylazine (3 mg/kg), and acepromazine (1 mg/kg) (Hobbs et al., 1991; Lipman et al., 1990; Ludders et al., 1987). The addition of butorphanol to ketamine/xylazine also increased the duration of reflex loss but with less physiologic embarrassment than that accompanying the addition of acepromazine (Marini et al., 1992). Ketamine (50 mg/kg IV) and 5% guaifenesin in 5% dextrose (200 mg/kg IV) were reported to provide safe and effective anesthesia for 30 minutes with preservation of heart rate and arterial blood pressure (Olson et al., 1987). Respiratory rate decreased by approximately 50% from baseline.

Chen and Bohner (1968) reported that a combination of ketamine (20 mg/kg IM) and 10% chloral hydrate (250 mg/kg) injected IV, over a 2–3 minute-period after ketamine-induced catalepsy had occurred, produced 1–1.5 hours of anesthesia without dramatic changes in arterial blood pressure or respiratory rate. In contrast, Hobbs et al. (1991) found that the identical regimen produced only 20 minutes of anesthesia and a 67% reduction in respiratory rate from baseline.

Telazol[®] is a combination agent consisting of the dissociative agent, tiletamine, and the benzodiazepine, zolazepam. Administered alone it does not provide sufficient analgesia for surgery but is useful for restraint and immobilization (Brammer et al., 1991; Doerning et al., 1992; Ward et al., 1974). The agent is also nephrotoxic in rabbits, as manifest by post recovery azotemia and urinary casts. Intranasal administration of Telazol (10 mg/kg) produced a mean duration of righting reflex loss of 44 minutes while eliminating the pedal reflex in only one of four rabbits (Robertson and Eberhart, 1994). Additional features of intranasal Telazol included good muscle relaxation, increased heart rate, and decreased respiratory rate. Serum creatinine and BUN were not measured in that study. The addition of xylazine (5 mg/kg IM) to Telazol (15 mg/kg IM) produced

surgical anesthesia lasting approximately 70 minutes (Popilskis et al., 1991). In contrast, Doerning et al. (1992) reported that as little as 7.5 mg/kg tiletamine was sufficient to produce mild nephrosis manifest as "scattered dilated tubules and occasional cellular casts." Azotemia did not occur at this dose. Tiletamine use is best avoided in the rabbit because of attendant nephrotoxicity.

C. Neuroleptanalgesia/Neuroleptanesthesia

The most widely investigated neuroleptanalgesic combinations used in the rabbit are fentanyl/droperidol (Innovar Vet[®]) and fentanyl/fluanisone (Hypnorm[®]).

Innovar Vet, used historically but seldom cited in the recent literature, contains fentanyl (0.4 mg/ml) and droperidol (20 mg/ml). It has been recommended for use as a sole agent for anesthesia (0.22 ml/kg) (Strack and Kaplan, 1968), for sedation during attempts at group housing (Love and Hammond, 1991), for sedation prior to cardiac puncture (0.17 ml/kg) (Lewis and Jennings, 1972), or prior to arteriocentesis of the central auricular artery (0.15, 0.17, 0.19, and 0.30 ml/kg) (Sartick et al., 1979); (0.125 ml/kg) (Tillman and Norman, 1983), and for stable neuroleptanalgesia using constant IV infusion (255 μ l/min of a 0.05 mg/ml fentanyl, 0.13 mg/ml droperidol solution in 5% dextrose) after a single IM dose (0.125 ml/kg) (Guerreiro and Page, 1987). Fentanyl/droperidol administered intranasally at a dosage of 0.3 mg/kg produced bradycardia, apnea, and 50% mortality (Robertson and Eberhart, 1994). The droperidol component of Innovar Vet has a longer duration of action than fentanyl; accordingly, animals may remain sedated well after the peak of neuroleptanalgesia has passed. Atropine or glycopyrrolate should be considered as a premedicant to avoid the bradycardia associated with the use of fentanyl or any of its congeners.

When Innovar Vet (0.15 ml/kg IM) was used in combination with either diazepam (2 mg/kg IV) or the α -2 agonist detomidine (20 μ g/kg IV), neither combination was found to improve the consistency or reliability of fentanyl/droperidol (Marini et al., 1993). Physiologic changes associated with Innovar Vet included decreases in heart rate (35%), arterial blood pressure (11%), respiratory rate (85%), and PaO₂(46%). Blood pressure was the parameter most severely affected by the addition of diazepam or detomidine. It was concluded that fentanyl/droperidol use at the dose selected be restricted to providing restraint for physical examination and minimally invasive diagnostic procedures.

Hypnorm is available in Europe but must be imported as an investigational drug in the United States. The commercial preparation contains 0.3 mg/ml fentanyl and 10 mg/ml fluanisone. At doses of 0.3–0.5 ml/kg, Hypnorm has been used for superficial surgeries and as a sedative prior to administration of inhalational agents (Green, 1975, 1982b). Respiratory depression, bradycardia, and poor muscle relaxation are characteristic of this agent

(Green, 1975). The addition of diazepam or midazolam to Hypnorm results in good surgical anesthesia of moderate duration (Flecknell et al., 1983; Flecknell and Mitchell, 1984; Hexeberg et al., 1995). Premedication with diazepam (1 mg/kg IV or 2 mg/kg IP), followed 5 minutes later by Hypnorm (0.2 ml/kg IM) produced 45–60 minutes of anesthesia and respiratory rate depression of 30–60% (Flecknell et al., 1983). Similarly, midazolam (2 mg/kg IP) has been used with Hypnorm (0.3 ml/kg IM) to produce surgical anesthesia of 100 minutes mean duration with respiratory rate depression of 29–62% (Flecknell and Mitchell, 1984). Increments of 0.05–0.1 ml/kg Hypnorm every 20–30 minutes and 1 mg/kg diazepam IV every 2–4 hours have been used to prolong anesthesia. Hypnorm (0.3 ml/kg SC) and diazepam (5 mg/kg SC) were used after atropine premedication (1 mg/kg SC) to provide anesthesia for orthopedic procedures in 565 rabbits (Mero et al., 1987). The subcutaneous route was used so that drug absorption might be delayed and the likelihood of respiratory depression reduced. The mortality rate for use of the combination in this manner was 1.4%.

Authors' Preference	
Agent	Fentanyl/fluanisone/midazolam
Route	Fentanyl/fluanisone IM; midazolam IV
Dose	Fentanyl/fluanisone 0.3 ml/kg; midazolam 0.5–2 mg/kg to effect
Comments	Fentanyl/fluanisone is administered as a premedication. Midazolam is then administered to the sedated rabbit to produce surgical anesthesia. Fentanyl/fluanisone is available in Europe.

A constant-rate infusion technique has been described in which a 1:10 dilution of Hypnorm is administered intravenously at a rate of 1–3 ml/kg/h (Flecknell, 1987). While most reports support the advantages of the Hypnorm/benzodiazepine combinations, Peeters et al. (1988) reported that only three of six rabbits were adequately anesthetized with Hypnorm (0.5 ml/kg IM) and diazepam (2 mg/kg IM). It should be noted, however, that forelimb withdrawal was used as the criterion for anesthesia in that study instead of the more commonly used parameter of hindlimb withdrawal. These responses are lost at different times in the rabbit.

Naloxone (at doses of 0.005, 0.01, and 0.1 mg/kg IV), doxapram (5 mg/kg IV), and various mixed agonist/antagonist opioids can reverse the respiratory depression caused by Hypnorm (Flecknell et al., 1989). The use of mixed agonist/antagonist opioids following neuroleptanalgesia has been termed *anesthesiè/analgesique sequentielle*, and permits restoration of physiologic variables to preanesthetic values while providing postoperative pain relief (DeCastro and Viars, 1968). The mixed agonist/antagonists were notable in that despite reversal of sedation and respiratory depression, analgesia persisted for varying periods after administration. Ranked by the duration of analgesia provided after reversal of fentanyl, meptazinol < pentazocine

< butorphanol < nalbuphine < buprenorphine. Buprenorphine (0.03 mg/kg IV) reversed Hypnorm associated depression of respiratory rate, normalized hypoxemia and arterial CO₂ retention, and provided 420 minutes of analgesia.

A combination containing etorphine (0.074 mg/ml and methotrimeprazine 18 mg/ml) (Small Animal Immobilon[®]) was used at dose rates of 0.05 and 0.025 ml/kg IM in the rabbit (Flecknell et al., 1983). There was insufficient analgesia at the lower dose but combining this dose with diazepam (1 mg/kg IV) produced surgical anesthesia in six of nine rabbits. Severe respiratory depression was associated with the higher dose of this agent.

Midazolam/xylazine/alfentanyl has been evaluated as an IV neuroleptanesthetic for rabbits (Borkowski et al., 1990). Midazolam (1 mg/kg) was administered over 15–30 seconds; xylazine (1 mg/kg) was administered over 10–15 seconds. Alfentanyl (0.1 mg/kg) was given incrementally over a 5-minute period; infusion was terminated for 2 minutes if muscle rigidity or opisthotonus occurred. Additional increments of one-half the calculated dose were administered every 15 minutes. Features of this regimen included good analgesia, incomplete or variable muscle relaxation, apnea in one of the seven rabbits during induction, and muscle rigidity with seizure activity during redose in three of the seven rabbits. Physiologic changes included marked depression of respiratory rate (90%), hypoxemia (60%), CO₂ retention, and decreased pH. Heart rate and mean arterial blood pressure were also depressed (30 and 35%, respectively, from baseline). The usefulness of this combination appears to be limited by these adverse effects. Another regimen using agents of the same three classes (midazolam (1.0 mg/kg IM)/medetomidine (0.2 mg/kg IM)/fentanyl (0.02 mg/kg IM) was evaluated in cross-bred chinchilla rabbits (Henke et al., 2005). This combination produced surgical anesthesia in most rabbits (14 of 19) but was associated with apnea of short duration (30 seconds) in a third of animals and respiratory depression sufficient to produce mild-to-moderate hypercapnia.

D. Miscellaneous Agents

The steroidal combination alphaxalone/alphadolone (12 mg/ml total steroids, Saffan or Althesin) was evaluated in rabbits and was found to produce useful, light to medium depth anesthesia of 8–10 minutes duration when used at a dose of 12 mg/kg IV (Green et al., 1978). Full recovery took 2–2.5 hours; incremental doses every 20 minutes could be used to prolong anesthesia for up to 8 hours. The agent has been recommended for superficial surgery or for ET intubation, the latter being accomplished by injecting one-half the calculated dose rapidly with the remainder given slowly to effect (Green, 1982b). Analgesia may be inconsistent with this agent despite reliable muscle relaxation. Saffan production has recently been discontinued by its manufacturer. The anesthetic agent Alfaxan, which consists of alfaxalone in a cyclodextrin formulation,

is now produced in the UK by the pharmaceutical company Vetoquinol UK Ltd. It is not available in the United States.

Bolus injection (1 mg/kg IV), followed by constant-rate infusion of alphaxalone/alphadolone (0.1 mg/kg/min IV) in chronically instrumented rabbits was used to determine the hemodynamic and reflex responses to this agent in comparison with propofol (Blake et al., 1988). The regimen used was sufficient to produce loss of righting and palpebral reflex but did not eliminate response to noxious stimuli. Mean arterial blood pressure, cardiac output, blood gas tensions, and total peripheral resistance were unchanged while heart rate increased approximately 20%. At low doses, alphaxalone/alphadolone preserves peripheral vasoconstrictor reflexes and may therefore be useful in pharmacologic studies that require integrity of these reflexes in a lightly anesthetized animals.

The alkyl phenol agent, propofol, reviewed by Sebel and Lowdon (1989), has been used to produce deep sedation during constant IV infusion in the rabbit (Adam et al., 1980; Blake et al., 1988; Glen, 1980). Glen (1980) used doses of 5–15 mg/kg of 2% propofol in 10% Cremophor EL and found only light anesthesia of short duration with “little reflex depression.” A mean “utilization rate,” obtained by the quotient of total dose administered and time from induction to recovery (head lift), was determined to be 1.55 mg/kg/min for the rabbit. This infusion rate provided light anesthesia without increasing recovery time. Blake et al. (1988) found that a bolus dose of 1.5 mg/kg followed by constant rate infusion of 0.2, 0.4, and 0.6 mg/kg/min produced either sedation (characterized by loss of righting and palpebral reflex) at the two lower infusion rates or anesthesia at the higher infusion rate. Blood gas tensions were preserved at all infusion rates and at the lower infusion rates there were no changes in mean arterial pressure. Cardiac output and heart rate were increased from baseline at the two lower infusion rates; total peripheral resistance was decreased. At the highest infusion rate, cardiac output and mean arterial pressure were decreased while total peripheral resistance remained depressed. Propofol caused a dose-related reduction in the range and gain of the baroreceptor reflex. These effects are concordant with the negative effects exerted by higher concentrations of propofol on cardiac contractility, left ventricular pressure, and heart rate in a modified Langendorff model of intact, isolated rabbit heart (Chen et al., 2006). The pharmacokinetics of single-bolus propofol (5 mg/kg) in the rabbit have also been described (Cockshott et al., 1992).

Constant rate infusion of propofol (30 ml/h of a 10 mg/ml concentration) achieved loss of righting reflex and ablation of gross purposeful movement response to tail clamp and intranasal administration of ammonia (Mustola et al., 2000). Propofol was superior to constant-rate infusions of thiopentone and ketamine with regard to return of righting reflex after termination of infusion. The larger volume of distribution, total body clearance, and faster elimination half-life of propofol compared to the other agents was credited with this feature. Potency ratios for propofol, thiopentone, and ketamine were 1:1.8:1.2 for loss of

righting reflex, 1:1.5:1.6 for loss of reaction to ammonia vapor, and 1:1.5:3.9 for the loss of reaction to tail clamping. Plasma concentrations of these drugs associated with loss of reaction to noxious stimuli were also determined.

The Cremophor EL diluent used in these studies was associated with hypersensitivity in humans and has now been replaced by an oil-in-water emulsion that presumably yields a less potent propofol formulation (Aeschbacher and Webb, 1993a). Using this formulation at an injection rate of 20 mg/kg/min, an ED₅₀ for induction was determined to be 6.44 mg/kg. Induction and recovery were smooth and rapid, with rabbits regaining the righting reflex 2–8.5 minutes after induction. Further studies using propofol induction (mean 7.3 mg/kg) and long-term IV infusion (mean infusion rate 0.876 mg/kg/min) produced light levels of anesthesia characterized by persistence of the pinna, pedal, and palpebral reflexes. Hypoxemia, hypertension, lipidemia, prolonged recovery, and mortality were other features of this regimen (Aeschbacher and Webb, 1993b). Propofol as a sole agent is apparently suitable only for induction and minimally invasive diagnostic procedures. Apnea, commonly encountered in other species during propofol induction, may be largely avoided in the rabbit provided administration is by slow IV injection (e.g., 45–90 seconds).

Ko et al. (1992) studied propofol induction after medetomidine–atropine or medetomidine–midazolam–atropine premedication. Rabbits were administered medetomidine (0.25 mg/kg IM) and atropine (0.5 mg/kg IM) or medetomidine (0.25 mg/kg IM), midazolam (0.5 mg/kg IM), and atropine (0.5 mg/kg IM) 5 minutes prior to propofol (4 mg/kg IV for the former group; 2 mg/kg IV for the latter). Each premedicant combination produced loss of righting reflex but persistence of pedal, ear pinch, palpebral, and corneal reflex. Propofol administration caused further loss of palpebral, ear pinch, and corneal reflex, but pedal withdrawal reflex was preserved. The addition of midazolam prolonged the loss of ear pinch reflex from a mean of 25 minutes to 37 minutes. No changes were seen from preanesthetic baseline in heart rate, respiratory rate, mean arterial pressure, or end-tidal CO₂ (ETCO₂). These combinations provided sufficient anesthesia to achieve ET intubation and may therefore be useful for induction or short-term anesthesia. Concordantly, Hellebrekers et al. (1997) reported that medetomidine premedication (0.35 mg/kg IM) followed by intravenously administered propofol (3 mg/kg) was sufficient to produce anesthesia of short duration (mean of 11 minutes) and depth adequate to ablate ear pinch and pedal withdrawal reflex.

Urethane (ethyl carbamate) has been used for anesthesia in rabbits both alone (Bree and Cohen, 1965; Murai and Ogura, 1978) and in combination with other agents (Moore et al., 1987; Wyler, 1974). The popularity of this agent can be attributed to its long duration of action (5–6 hours) and excellent muscle relaxation (Maggi et al., 1984; Princi et al., 2000). Disadvantages of urethane include carcinogenicity, slow recovery, hypotension, reduced response of vascular smooth muscle to norepinephrine,

a wide range of endocrine effects, tissue slough at extravasation, venodilation of the vessel used for injection, hemolysis, and transient reduction of hematocrit (Bree and Cohen, 1965; Maggi et al., 1984). Its carcinogenic properties and the attendant hazards to personnel require that its use be regulated by institutional safety personnel. Doses of 1.5 g/kg (20% urethane slowly IV to effect) (Bree and Cohen, 1965), 1.0 g/kg IP with 50–100 mg supplements IV as needed (Xu et al., 1998), 10 ml/kg of a 10% solution IP (1.0 g/kg) (Princi et al., 2000) and 1–1.6 g/kg IP have been recommended (Green, 1982b). These recommendations notwithstanding, IP doses of 1.5 and 1.75 g/kg of a 20% urethane solution were associated with postoperative death in one study (Bree and Cohen, 1965).

Urethane combinations include chloralose/urethane (Dorward et al., 1987; Korner et al., 1968; Warren and Ledingham, 1978; Wyler, 1974) and urethane/acepromazine (Moore et al., 1987). Chloralose/urethane has been widely used for nonsurvival procedures requiring long-term anesthesia. Physiologic features of this combination include respiratory rate depression (65%), tachycardia, increased total peripheral resistance, increased venous blood pressure, decreased total body blood flow, and unchanged arterial blood pressure (Wyler, 1974). It is widely held that chloralose/urethane preserves or enhances baroreceptor reflexes, making it popular in studies where preservation of these reflexes is desirable (Sebel and Lowdon, 1989; Warren and Ledingham, 1978). Dosage recommendations include the following:

- 800 mg/kg of 25% urethane IV with 40–60 mg/kg of 1% chloralose IV initially, followed by 3–4 ml/h of 1% chloralose (Dorward et al., 1987).
- 400 mg/kg of 25% urethane IV with 60 mg/kg of 1% chloralose IV initially, followed by 1–3 ml of 1% chloralose every 30–50 minutes (Jenkins, 1987).
- 500 mg/kg urethane (% solution not reported) IV with 50 mg/kg chloralose IV initially, followed by supplemental urethane 100 mg/kg and chloralose 10 mg/kg every 50–60 minutes (Raimondi et al., 1996)

Urethane/acepromazine has been evaluated in the rabbit as a long-term anesthetic (Moore et al., 1987). Light anesthesia was produced by premedication with acepromazine (1 mg/0.46 kg IM), followed in 15 minutes by 1 g/kg urethane IV. The urethane was injected over a period of 5–10 minutes followed by a saline flush. Loss of consciousness persisted for over 12 hours. The level of anesthesia was described as comprising loss of responsiveness to superficial, but not to deep visceral pain. Heart and respiratory rates decreased over the first hour but then stabilized. Administration of a higher dose of urethane (1.3 g/kg IV) after acepromazine premedication resulted in deep anesthesia appropriate for abdominal and thoracic procedures. Pedal reflex was still absent at 18 hours after administration with this dose. Physiologic changes paralleled those measured with the lower dose regimen. Vibrissae twitching and flaring of the nares have been observed in acepromazine/urethane-anesthetized rabbits

by one of the authors (RPM) and is premonitory of anesthetic emergence.

V. INHALATION ANESTHESIA

The use of inhalants, while requiring special equipment and training, provides excellent reliability, efficacy, and anesthetic depth. These features are especially important in rabbit anesthesia where many injectable combinations that are adequate for procedures involving superficial structures are inadequate for more invasive manipulations. Reduction in recovery time is an additional benefit of inhalant anesthesia. The use of inhalants in specific experimental protocols may be precluded, in that effects such as cardioprotection and reduction of infarct size have been demonstrated (Cope et al., 1997). Serum catecholamine and serum glucocorticoid concentrations in rabbits anesthetized with isoflurane or halothane have been published (Gil et al., 2005).

Once the rabbit is intubated, inhalants may be administered using various circuits, and animals may be ventilated or be allowed to breathe spontaneously. The Rees modified T-piece and Bain circuits are traditionally considered the most appropriate circuits for animals comprising the range of weights of most rabbits; Magill and circle circuits have also been used (Nelson et al., 1990; Peeters et al., 1988). The range of fresh gas flows reported in the maintenance of spontaneously breathing animals is 1–3 L/min (Green, 1982b; Kent, 1971; Kumar et al., 1993; Peeters et al., 1988). Alternatively, one may choose to administer a volume of fresh gas that is two to three times the minute respiratory volume of the animal (Flecknell, 1987). Twice the minute respiratory volume of 100% O₂ delivered via Bain circuit is the method used for inhalant administration in our surgical laboratory (Marini, personal experience). A 2 kg rabbit breathing at 30 times/min would be expected to have a respiratory minute volume of 0.9 L (the product of respiratory rate and an estimated tidal volume of 7–10 ml/kg). Rebreathing is likely to occur for small veterinary patients if a fresh gas flow of 500 ml/min is used with a coaxial circuit. In the example above, the rabbit would receive 1.8–2.7 (2–3) L/min fresh gas flow. Monitoring ETCO₂ helps avoid hypercapnia and its attendant metabolic effects.

Artificial ventilation has most commonly been used in the rabbit in the setting of acute preparations involving paralytics. Ventilatory parameters during IPPV can be determined by estimates of tidal volume and empiric settings of ventilatory rate, by use of pressure cycling to terminate inspiration at a chosen airway pressure, or by guidance of ventilatory settings by blood gas parameters. Tidal volume and respiratory rate settings of 10 ml/kg, 45 breaths/min (Chakrabarty et al., 1991; Ishibe et al., 1993), 15 ml/kg, 20 breaths/min (Drummond, 1985; Drummond et al., 1987), 8 ml/kg, 20 breaths/min (Aeschbacher and Webb, 1993b), and 15 ml/kg, 30 breaths/min (Kumar et al.,

1993; Patel and Mutch, 1990) have been reported. The newer ventilation modalities, high-frequency jet ventilation, continuous positive pressure ventilation with positive end-expiratory pressure, oscillatory ventilation, and negative impedance ventilation have been described in the rabbit, often as models for ventilation in human beings, but have not replaced traditional methods (Baum et al., 1989; Lebowitz, 1990; Mook et al., 1984). In a study of ventilatory modes at inverted inspiratory to expiratory ratio (inspiratory time: expiratory time of 2:1 instead of the more physiologic 1:2) in a rabbit model of subarachnoid hemorrhage, Taplu et al. (2003) showed that both volume and pressure cycled modes were associated with increased airway pressures. Additionally, inverse ratio ventilation resulted in a dramatic elevation in intracranial pressure.

Methoxyflurane, halothane, and ether, once widely used for anesthesia in the rabbit, have been largely supplanted by isoflurane. Reports on the use of desflurane and enflurane exist, but these agents do not appear to be in common usage (Drummond, 1985; Hedenqvist et al., 2001; Lockhart et al., 1991; Stadnicka et al., 1993; Tashiro et al., 1986). The inhalant of choice in many surgical laboratories is isoflurane. The advantages of isoflurane include cardiac safety, rapid induction and recovery due to low blood solubility, minimal hepatic transformation, and reduced viscerotoxicity. The disadvantages are cost, potential increase in breath holding at the start of exposure, reduced respiratory anesthetic index, and hypotension. Physiologic effects of 1.3 minimal alveolar concentration (MAC) isoflurane anesthesia include 21% reduction in mean arterial pressure, 18% increase in heart rate, 21% reduction in renal blood flow, and preservation of hepatic blood flow, cardiac output, respiratory rate, and arterial partial pressure of carbon dioxide (PaCO₂) (Blake et al., 1991). Cardiac output in rabbits with Adriamycin-induced heart failure was unchanged by isoflurane but decreased (20%) by halothane (Blake et al., 1991), a reflection of isoflurane's high cardiac anesthetic index (the quotient of the dose of an agent required to produce cardiac arrest and the MAC). Indices of cardiac contractility measured via two-dimensional transthoracic echocardiography were better preserved by 1 MAC isoflurane in 50% nitrous oxide than an equipotent concentration of halothane in nitrous oxide (Marano et al., 1997). Mean heart rate and arterial pressure were not significantly different. Cerebral uptake and elimination of isoflurane was found to be slower than desflurane's but faster than halothane's (Lockhart et al., 1991). Several clamping-stimuli generated MAC values for isoflurane in rabbits have been published: 2.05 ± 0.18% (Drummond, 1985); 2.07 ± 0.09% (Imai et al., 1999); 2.08 ± 0.02% (Valverde et al., 2003). A recent study comparing MAC values and different stimuli in the isoflurane-anesthetized rabbit showed that the MAC for surgical incision (0.9 ± 0.02%) was considerably lower than that for electrical stimulation of the fore or hindlimb (2.08 ± 0.02%) or those for clamping stimuli (2.08 ± 0.02%) (Valverde et al., 2003). The MAC for halothane in the rabbit is 1.39 ± 0.32% and that for enflurane is 2.86 ± 0.18%. Anesthetists accustomed to the use of halothane will notice that

maintenance concentrations of isoflurane are higher for a given procedure or surgical stimulus.

Authors' Preference	
Agent	Ketamine/xylazine followed by isoflurane
Route	Ketamine/xylazine (IM); isoflurane (inhalation)
Dose	Induction: Ketamine 35 mg/kg; xylazine 5 mg/kg Maintenance: Isoflurane 1–4%
Comments	Our anesthetic regimen of choice for invasive procedures such as celiotomy or thoracotomy.

Halothane is relatively inexpensive and provides safe and effective anesthesia in rabbits. Physiologic effects of halothane anesthesia include reductions in cardiac output, arterial blood pressure, PaCO₂, and respiratory rate and increases in venous blood pressure, plasma renin, PaCO₂, and heart rate (Sartick et al., 1979; Wyler, 1974; Wyler and Weisser, 1972). Total peripheral resistance remains unchanged or is mildly elevated, suggesting that the mechanism of hypotension and reduced cardiac output is myocardial depression (Wyler and Weisser, 1972). Reduction in organ blood flow occurs in proportion to the reduction in cardiac output with preservation of flow to brain, adrenals, testes, and muscle in one study (Wyler and Weisser, 1972) and brain, stomach, appendix, arterial hepatic flow, and muscle in another (Wyler, 1974). Sartick et al. (1979) reported that cardiac output and arterial blood pressure returned to preanesthetic baseline values 15 minutes after termination of halothane anesthesia. Plasma renin concentrations returned to baseline by 210 minutes after anesthesia. A comparison of isoflurane and halothane on cardiopulmonary variables in the rabbit demonstrated enhanced dose-dependent respiratory depression of isoflurane (decreased respiratory rate and CO₂ retention) and comparable levels of hypotension (central auricular mean arterial pressure: 52 mmHg for halothane and 55 mmHg for isoflurane at equivalent multiples (0.8) of MAC; Imai et al., 1999.)

Sevoflurane use has increased in the rabbit since the publication of the first edition of this text (Ishibe et al., 1993; Scheller et al., 1988). It is an agent characterized by rapid induction and recovery, lack of odor, and good acceptance by human patients where the agent was administered by using a face mask (Flecknell et al., 1999). Unfortunately, rabbits are not as compliant with face mask or chamber induction, and may struggle violently and experience apnea and its physiologic consequences when administered the agent in this fashion (Flecknell et al., 1999). Mask induction and maintenance with sevoflurane (3–5% in balanced oxygen) was used in a study evaluating epidural anesthetic effects of deoxyaconitine, a compound from aconite tuber, a traditional Oriental medicine (Komoda et al., 2003). Anesthesia maintenance with sevoflurane at 3.7% (1 MAC) has been described after buprenorphine premedication (0.05 mg/kg IV) and propofol induction (8 mg/kg IV) (Martin-Cancho et al., 2006). Sevoflurane administration to rabbits causes dose-dependent reduction in mean arterial

pressure by both a direct myocardial depressant effect and a decrease in systemic vascular resistance (Ma et al., 1998). In the setting of basal anesthesia maintained by constant-rate infusion of chloralose, a reduction in MAP of 80–40 mmHg was effected by concentrations of 1 and 4% sevoflurane, respectively, without concomitant change in heart rate or renal sympathetic nerve activity (RSNA), the latter decreased at 4% sevoflurane. Through the use of pressor and depressor agents it has been demonstrated that the apparent absence of autonomic response at these sevoflurane concentrations was determined to be due to the mitigating effects of depressed but functioning baroreflexes on concomitant direct inhibitory effects on heart rate and RSNA (Ma et al., 1998).

In another study by the same authors, chloralose-anesthetized rabbits were used to evaluate sevoflurane for its ability to obtund the autonomic response to a noxious stimulus (Ma et al., 1999). Blunting the autonomic response to surgical trauma is considered desirable and is associated with improved outcomes, but should not be achieved at the expense of direct cardiovascular depression associated with high concentrations of anesthetic agents. A regimen characterized by maintenance of reasonable cardiopulmonary status with concomitant suppression of the neurohumoral reflex response to surgical stimuli would be of considerable value to patients and anesthetists. Higher concentrations of sevoflurane (5 and 6%) than that used in their previous study caused significant decreases from baseline of heart rate and mean arterial pressure (maximal effect of 14 and 55%, respectively). Phrenic nerve activity, an index of central respiratory control, also decreased linearly with increasing sevoflurane concentrations. Sevoflurane obtunded the arterial pressure response to tibial nerve stimulation to approximately 45% of its control value at 3% and completely abolished it at 6%. The heart rate response was blunted to 20% of its control value at 3% sevoflurane and was almost completely abolished at 5%. These depressant effects were greater than sevoflurane's effect on phrenic nerve activity. When the opioid remifentanyl was added to sevoflurane, the two agents were found to act synergistically with regard to resting heart rate, resting mean arterial pressure, phrenic nerve activity, and depression of the arterial pressure response to tibial nerve stimulation; they acted additively with regard to the evoked heart rate response. Their synergistic effect on phrenic nerve activity was adequately profound that the authors recommended the use of assisted ventilation during sevoflurane–remifentanyl anesthesia. In the clinical setting, sevoflurane maintenance after propofol induction is associated with rapid, smooth recovery (Flecknell, personal experience). Mask induction with sevoflurane after premedication with either acepromazine (1 mg/kg SC), diazepam (0.5–1.0 mg/kg IM), or medetomidine (0.1–0.5 mg/kg SC) may also be used, but the operator must observe for periods of breathholding (Flecknell and Liles, 1996).

The use of nitrous oxide as a carrier gas during induction has been advocated in the past, but concern over operating theater pollution in today's setting may limit the use of this

agent. Nitrous oxide may be used as a carrier gas or as a background agent in long-term injectable techniques (Green, 1982b). When compared to pentobarbital, ketamine/xylazine, and fentanyl/fluanisone/diazepam, halothane in O₂/nitrous oxide (1:2) was found to provide the most reliable anesthesia (Peeters et al., 1988). Halothane/nitrous oxide anesthesia was associated with reduction in blood pressure (37.5%) and an increase in heart rate (24%); rabbits recovered from 50 minutes of general anesthesia in 25 minutes. Care should be taken to administer 100% O₂ without nitrous oxide for 5–10 minutes at the end of a procedure to avoid diffusion hypoxia. Investigators performing intracranial procedures should be aware that nitrous oxide will increase cerebral blood flow to varying degrees depending on background anesthesia (Drummond et al., 1987).

Authors' Preference	
Agent	Isoflurane
Route	Endotracheal tube and coaxial circuit
Dose	Induction: Premedication with 1–2 mg/kg diazepam or midazolam IV; anesthetic chamber or face mask using incrementally greater concentration of isoflurane from 1 to 4%, increasing by 1% every 30 seconds. Maintenance: Isoflurane 1–4% via endotracheal tube (preferred) or face mask
Comments	Use of isoflurane as the sole agent of anesthesia induction may be associated with breathholding and distress.

Authors' Preference	
Agent	Sevoflurane
Route	Endotracheal tube and coaxial circuit
Dose	Induction: Propofol IV over 60–90 seconds Maintenance: Sevoflurane
Comments	Use of sevoflurane as the sole agent of anesthesia induction may be associated with breath-holding and distress. Smooth, rapid recoveries occur after propofol induction.

VI. REGIONAL ANESTHESIA

A. Local or Regional Anesthesia

Local or regional techniques may be used in combination with inhalant or injectable anesthetics as they are in other species (Lockhart et al., 1991; Madsen et al., 1993; Raman et al., 1989). Studies in human beings suggest that preoperative infiltration of incision sites with local anesthetics may affect the course of postoperative pain, causing a decrease in the number of patients requiring analgesics or increasing the time to first request for analgesics (Coderre et al., 1993). Lidocaine and bupivacaine are commonly used in our surgical laboratory for local infiltration of incision sites. Specific nerve block techniques and sites are only rarely described for use in the rabbit. Saito et al. (2002) described appendectomy of rabbits after “extended unilateral anesthesia.” The latter was achieved by insertion of a catheter

into the endothoracic fascia of the right paravertebral region, with subsequent injection of 3 ml of 2% mepivacaine through the catheter seated at the level of the 11th thoracic vertebra.

B. Spinal Anesthesia

Spinal anesthesia has not been widely used clinically in the rabbit but reports promoting its use as a model for evaluating the pharmacology and toxicology of spinal anesthesia or analgesia have appeared in the literature (Adams et al., 1974; Crawford et al., 1993; Demeril et al., 2006; Dollo et al., 2004a, 2004b; Durant and Yaksh, 1986; Erdine et al., 1999; Hino et al., 2001; Hogan et al., 1998; Hughes et al., 1993; Jensen et al., 1992; Komoda et al., 2003; Langerman et al., 1990; Madsen et al., 1993; Malinovsky et al., 1991, 2002; Ugur et al., 2005; Vranken et al., 2006). Both the epidural (Madsen et al., 1993) and subarachnoid (Durant and Yaksh, 1986; Jensen et al., 1992; Langerman et al., 1990) spaces have been cannulated to allow chronic administration of local anesthetics. Both procedures required surgical exposure of the lumbar spinal column and incision of the ligamentum flavum. In one study, the duration of motor blockade from injected anesthetics was dose-dependent; the relative pharmacologic activity of the agents tested was amethocaine (duration, approximately 170 minutes) > bupivacaine (duration, approximately 100 minutes) > lidocaine (duration, approximately 27 minutes) > procaine (duration, approximately 20 minutes) (Langerman et al., 1990).

A more recent model used the space between the *apex coccyis sacri* and first coccygeal vertebra to cannulate the epidural space (Malinovsky et al., 1997). A skin incision of 1 cm was made at the base of the tail, the ligamentum was punctured, and a 23 gauge catheter was advanced 10 cm into the lumbar epidural space. Cranial insertion of the catheter for this distance placed the tip at L6 in 2.5–2.7 kg New Zealand white rabbits. Using this technique, the authors investigated the duration of motor block when using increasing concentrations of lidocaine or bupivacaine. One milliliter volume of lidocaine (0.5, 1.0, and 2.0%) resulted in complete motor block of 27, 43, and 51 minutes respectively, while 1 ml volume of bupivacaine (0.25 and 0.5%) produced complete motor block of 53 and 93 minutes, respectively (Malinovsky et al., 1997). Catheters were maintained for 2 months without clinical sequelae or significant histologic change.

In another study investigating the pattern of distribution of epidurally administered contrast medium in rabbits, Kim et al. (1998) used epidural catheters located at either T7 or T12 to demonstrate differential spread at these two sites. At the mid-thoracic level, the medium spread equally in cranial and caudal directions, while at T12, the distance of cranial spread was twice that of caudal spread. Consequently, the authors recommended injection at the site of interest for mid-thoracic segments, and 1–3 segments caudal to the site of interest for caudal thoracic or lumbar segments.

Kero et al. (1981) recommended spinal anesthesia for hysterotomy, using 20 mg (0.5 ml) of mepivacaine injected "through the lumbar spinal interspaces at a level 1 to 2 interspaces higher than the iliac crest." Rabbits were held so that their spines were arched; 0.6 × 25 mm needles were used, the points being directed in a caudoventral direction. Motor function was eliminated for 55 minutes using this technique. The same procedure performed at 2–3 lumbar interspaces cranial produced permanent paralysis. Hughes et al. (1993) described a technique for epidural administration of local anesthesia in conscious rabbits. Twenty gauge, 1.5 cm, short beveled spinal needles were passed through the lumbosacral space with the needle oriented perpendicular to the skin. The duration of sensory loss, loss of weight bearing, and paresis was determined for 2% lidocaine with and without 1:200,000 epinephrine and 0.5% bupivacaine used at a volume of 0.2 ml/kg. These studies notwithstanding, it is believed that rabbits should be heavily sedated prior to spinal anesthesia so that the potential for movement during administration and subsequent nerve damage are reduced.

VII. SPECIAL ANESTHETIC CONSIDERATIONS

A. Hypnosis

Hypnosis, or the immobility response, while fascinating to the animal scientist, is limited in its utility by variability in response and duration among rabbits (Danneman et al., 1988). Many techniques have been described to induce this phenomenon: maintaining rabbits in lateral recumbency in a darkened room for 15 seconds (Klemm, 1965); traction on the head and neck while in dorsal recumbency (Danneman et al., 1988); forced dorsal recumbency while stroking the animal's abdomen and incantation (Rapson and Jones, 1964); and restraint of the animal in dorsal or ventral recumbency with the limbs immobilized and while exerting gentle traction on the head (Gruber and Amato, 1970). Features of hypnosis include miosis, increased depth of respiration, analgesia, reduced respiratory and heart rate, and decreased blood pressure. Danneman et al. (1988) showed that naloxone had little effect on hypnosis and that some rabbits showed an autonomic response to noxious stimuli while showing classical signs of the immobility response. The authors concluded that hypnosis was not sufficiently reliable or efficacious to be considered a replacement for analgesics or anesthetics.

B. Anesthesia during Ophthalmic Procedures

Important criteria for anesthesia during ophthalmic surgery include adequate depth, relaxation of the extraocular muscles, and control of intraocular pressure (Ludders, 1993). Procedure length, ability to increase anesthetic depth with increments

of the anesthetic, site of manipulation within the eye, and research goals will also determine the choice of anesthetic. Topical anesthetic agents like 0.3% proparacaine are sometimes used as adjuncts to anesthesia in procedures involving the cornea (Sherrard, 1966). Atropine or glycopyrrolate is used in ophthalmic procedures to avoid the oculocardiac reflex.

Anesthetics may affect retinal fine structure, intraocular pressure, and the volume of intraocular air (Antal, 1985; Artru and Momota, 1999; Boucher and Meyers, 1983; Johnson et al., 1973; Schutten and Van Horn, 1977). Ketamine and ketamine/pentobarbital have been shown to effect peak increases in intraocular pressure by 2.2 and 7.1 mm, respectively. The increase was unaffected by atropine premedication and lasted for 10 minutes (Schutten and Van Horn, 1977). Nitrous oxide use may increase intraocular pressure and has been shown to promote the absorption of air from eyes that have received total air–fluid exchange following lensectomy and vitrectomy (Boucher and Meyers, 1983). In contrast, IV methohexital anesthesia was associated with a significant decrease in intraocular pressure but produced hypoxic alterations of retinal photoreceptors (Antal, 1985). These changes persisted for the duration of the study (48 hours); effects on vision were not evaluated. Urethane alone and a combination of 0.5% halothane/nitrous oxide, suxamethonium and phencyclidine anesthesia, were found to preserve retinal ultrastructure while 0.5–2.5% halothane/nitrous oxide caused variable degrees of damage to photoreceptors and retinal pigment epithelium. The latter change was duration-dependent; anesthesia of 5–6 hours duration was associated with the injury while anesthesia of 15 minutes duration was not (Johnson et al., 1973). Intraocular pressure was decreased in rabbits anesthetized with sevoflurane (1, 2, and 3%) or sevoflurane and remifentanyl (1% and 0.65 µg/kg/min IV, respectively) when compared to historical values obtained from awake animals (Artru and Momota, 1999). The decrease was similar in magnitude to that previously reported in rabbits anesthetized with a variety of agents.

C. Anesthesia for Fetal Surgery

Reports on anesthetics used in fetal rabbit surgery include barbiturates, ether, and halothane (Cowen and Laurensen, 1959; Thomasson and Ravitch, 1969; Nelson et al., 1990). The former two agents were characterized by high fetal and/or maternal loss while the latter was used in over 4,000 fetal operations with less than 5% maternal mortality and postoperative fetal survival close to 90% (Nelson et al., 1990). In that study, does were premedicated with ketamine (20 mg/kg) and acepromazine (1 mg/kg); one-half the dose was administered IM and the remainder was administered IV 20 minutes later. Halothane was administered via face mask and circle circuit with CO₂ absorption and vaporizer setting of 1–1.5% halothane in 1 L/min flow of O₂. Uterine relaxation during halothane anesthesia was considered to be an important determinant of success.

Beaudoin et al. (1998) have described a model of embryonic surgery in rabbits.

D. Long-term Anesthetic Preparations

Many regimens have been described for maintenance of anesthesia for extended periods of time during nonsurvival procedures or under special experimental circumstances like extracorporeal circulation. While they are presented briefly here, readers should consult the original papers for details to determine if a particular regimen is appropriate in their setting. For those regimens using paralytics, guidelines promulgated by the NIH Workshop on "Preparation and Maintenance of Higher Mammals During Neuroscience Experiments" (NIH, 1991) should be used to provide assurance that adequate depth of anesthesia is produced.

Green (1982b) reported three methods of providing basal narcosis-light anesthesia, all of which involved intubation and IPPV with oxygen/nitrous oxide (1:1). They are listed in the order of his preference:

- Induction: Propanidid (no longer available) (10 mg/kg IV)
Maintenance: Alpha-chloralose IV (60–80 mg/kg)
- Induction: Hypnorm (0.3 ml/kg IM) and inhalation of halothane in oxygen/nitrous oxide (1:1)
Maintenance: Hypnorm (0.15 ml/kg IM) at 30–40 minute intervals; and pentobarbital (3–5 mg/kg IV) as needed every 45–60 minutes
- Induction: Alphaxalone/alphadolone (8 mg/kg IV)
Maintenance: Continuous IV infusion alphaxalone/alphadolone (6 mg/kg/h) starting 15 minutes after the initial dose

Investigations studying the physiology of cerebral blood flow and cerebral anesthetic uptake and elimination have provided innovative regimens for anesthesia of long duration (Drummond et al., 1987; Hindman et al., 1990; Lockhart et al., 1991; Mills et al., 1987; Patel and Mutch, 1990). Four are outlined below:

- Induction and initial instrumentation: IV methohexital, 70% nitrous oxide, local infiltration of 1% lidocaine.
Maintenance: Pancuronium (2 mg/h IV); 70% nitrous oxide; methohexital (3 mg/kg/h IV) (Lockhart et al., 1991).
- Induction and initial instrumentation: Ketamine (35 mg/kg IM) and xylazine (5 mg/kg IM).
Maintenance: 60% nitrous oxide, ketamine (10 mg/kg/h IV), pancuronium as needed (Mills et al., 1987).
- Induction and initial instrumentation: Chamber induction with 4% halothane or 6% isoflurane in oxygen; pancuronium (2 mg IV); halothane or isoflurane (0.75–1.0 MAC) and 70% nitrous oxide.

Maintenance: This study evaluated effects of background anesthesia on cortical blood flow. Maintenance anesthesia was therefore provided by the regimens under study. Wound margins were infiltrated with 0.25% bupivacaine and following treatments were administered: 0.5 and

1.0 MAC isoflurane with 70% nitrous oxide or 70% N₂; 0.5 and 1.0 MAC halothane with 70% nitrous oxide or 70% N₂; 0.5 MAC isoflurane or halothane and 10 mg/kg morphine sulfate, administered as a slow IV bolus (2 mg/kg/h) with 70% nitrous oxide or 70% N₂ (Drummond et al., 1987).

- Induction and initial instrumentation: Chamber induction 5% halothane; succinylcholine 2 mg/kg IV; 1.5% halothane with oxygen/nitrous oxide (1:2); succinylcholine (3 mg/kg/h).
Maintenance: IV fentanyl (loading dose 100 µg/kg; infusion 2.5 µg/kg/min) and diazepam (loading dose 2 mg/kg, infusion 50 µg/kg/min); pancuronium (0.1 mg/kg) (Hindman et al., 1990).

De Mulder et al. (1997) described continuous total intravenous anesthesia (TIVA) for maintenance of a vagotomized New Zealand white, open thorax preparation.

- Induction: Ketamine 25 mg/kg and xylazine 15 mg/kg IM
Maintenance: IV propofol (0.6 mg/kg/min), fentanyl (0.48 µg/kg/min), and vecuronium (0.003 mg/kg/min). TIVA with these agents allowed constant, cardiovascular stability for long-term experimentation in an acute setting.

A study investigating myogenic motor-evoked potentials and their potential use in monitoring patients in thoracoabdominal aortic surgery used the following regimen (Sakamoto et al., 2003).

- Induction and initial instrumentation: Ketamine 50 mg IM in 2.0–2.5 kg rabbits; continuous IV infusion of ketamine (25 mg/kg/h) and fentanyl (30 µg/kg/h) in lactated Ringer's solution (4 ml/kg/h)
Maintenance: The TIVA regimen above and a bolus of propofol (10 mg/kg IV) followed by continuous IV infusion (0.8 mg/kg/min)

Hayashida et al. (2004) have developed a rabbit model for quantification of the behavioral and physiologic characteristics of select agents. Anesthesia was achieved using isoflurane induction (5%) via nose cone and maintenance isoflurane (3%) was delivered via ET tube. After instrumentation, stepwise reduction of isoflurane to 0% was followed by a 30-minute stabilization period, after which the agent of interest was evaluated. The analgesic, sedative/hypnotic, and physiologic features of various doses and infusion regimens of fentanyl and remifentanyl have been evaluated in this model (Hayashida et al., 2003, 2004).

VIII. INTRAOPERATIVE SUPPORT AND MONITORING

Constant vigilance is the anesthetist's watchword; one person who is trained in appropriate decision making should be

assigned the task of monitoring anesthesia. Patient monitoring can be considered to be comprised of three areas: reflexes, cardiopulmonary parameters, and body temperature. These three areas should be evaluated with regard to presurgical baseline and response to surgical stimuli or intraoperative events. Newer and less common modalities of anesthesia monitoring, EEG and bispectral index, have also been described (Martin-Cancho et al., 2006; Vachon et al., 1999).

A. Reflexes

Traditional reflexes used in the monitoring of rabbit anesthesia include righting, palpebral, corneal, pedal withdrawal, and pinna reflex. It is widely held that the pinna reflex (ear movement in response to a compressive force) is the most accurate measure of depth of anesthesia, followed by the pedal withdrawal, corneal, and palpebral reflexes, in that order (Borkowski et al., 1990). Corneal reflex may be preserved until very deep levels of anesthesia are achieved. Care should be exercised, however, as the presence or absence of these reflexes with different anesthetics in the rabbit defies generalization. Imai et al. (1999) determined that eyelid aperture increases with increasing anesthetic dose (0.8, 1.0, 1.5, and 2.0 MAC) for both isoflurane and halothane anesthesia in the rabbit.

Muscle tone, jaw tone, vocalization, and gross purposeful movement in response to surgical stimulus are also indices of anesthetic depth.

B. Body Temperature

Hypothermia can alter metabolic clearance of injectable agents and decreases MAC of inhalants. Rectal temperature can be measured intermittently or continuously using available instrumentation. Esophageal temperature probes may provide less variability than rectal probes and provide continuous monitoring. Feedback control of body temperature can be achieved through commercially available devices and should be considered for procedures involving prolonged exposure of body cavities or extended durations of anesthesia. Rabbits should be protected from cold surfaces during anesthesia by table drapes, foam pads, or similar devices. Supplemental heating can be provided with circulating hot water blankets, warmed irrigation fluids, judiciously placed heat lamps, and IV fluids heated by fluid warmers.

C. Cardiopulmonary Parameters

In the absence of hemorrhage, hypothermia, hyperthermia, drug effects, and vasovagal or oculocardiac reflexes, changes in respiratory and cardiovascular parameter values from pre-anesthetic baseline may comprise an autonomic response to a surgical stimulus. The value of ablation of these responses and

their relationship to anesthetic depth has been debated (Kulli and Koch, 1991; Weinger and Koob, 1990) and is beyond the scope of this chapter. Perhaps it is sufficient in the setting of experimental anesthesia and surgery to say that ablation of autonomic response provides compelling evidence that there is adequate depth of anesthesia while absence of ablation does not necessarily indicate that anesthetic depth is inadequate. The reader is referred to the thoughtful discussion of this issue by Stanski (1990).

Respiratory rate can be assessed by direct observation of chest wall or abdominal wall movements, use of respiratory monitors that adapt to the ET tube, esophageal stethoscopes, pediatric pneumotachometers, and chest wall plethysmographs. Cerebrospinal fluid movement may also be used to determine respiratory rate during intracranial procedures. Alternatively, respiratory rate may be set by the anesthetist during mechanical ventilation of the lungs. Assessment of breathing pattern, depth of respiration, and respiratory effort may be made by direct observation or through use of pneumotachometers with circuit integrators that measure or calculate respiratory flow, tidal volume, and minute ventilation (Guerreiro and Page, 1987; Rich et al., 1990). Information on the adequacy of ventilation can be derived through observation of mucous membrane color, blood gas analysis, ETCO₂ determination, and pulse oximetry. The rabbit is well suited for routine blood gas evaluation because of the availability of peripheral sites for arterial cannulation or puncture. Pediatric pulse oximeters may be used to provide information on arterial O₂ saturation (Aeschbacher and Webb, 1993; Robertson and Eberhart, 1994). Digits and tongue are usual sites for pulse oximeter probes; ears may give spuriously low readings with some anesthetics (Orr et al., 2005). ETCO₂ measurement has been specifically evaluated during spontaneous and controlled ventilation in the rabbit with specific regard to the site of sampling (Rich et al., 1990). ETCO₂ determined at the pulmonary tip of the ET tube and that determined 12 cm from the pulmonary tip differed by less than 1 mmHg, independent of the mode of ventilation or fresh gas flows. The ETCO₂ was also found to be a reasonable indicator of PaCO₂, the values determined for each differing by only 2.9 and 3.6 mmHg at the distal tip and 12 cm mark, respectively.

Cardiovascular parameters that may be routinely monitored in the rabbit include mucous membrane color and capillary refill time, heart rate, arterial blood pressure, and pulse rate and character. Heart rate may be monitored continuously by esophageal stethoscope or EKG monitor and intermittently by direct auscultation with a stethoscope or palpation of the maximal apex beat through the chest wall. The high heart rate of rabbits and the potential occurrence of both T and U waves have led to the development of specific criteria for QT (or QU) interval measurement (Farkas et al., 2004). These measurements are of particular importance in toxicology, where anesthetized rabbits are used to evaluate the QT prolongation effects of repolarization-delaying agents. Arterial blood pressure may be measured directly through arterial cannulation or

indirectly through the use of appropriately sized limb bands (Ko et al., 1992). In a study comparing direct and indirect methods, central auricular pressure was well correlated with aortic pressure measurements but not with hindlimb indirect measurements. Forelimb indirect measurements were correlated with aortic pressure at normal and low arterial pressure but not at high pressure; accuracy of the indirect method with direct aortic pressure was “moderate” (Ypsilantis et al., 2005). Pulse rate and character may be evaluated by palpation of the saphenous artery, carotid artery, femoral artery, or through the use of pressure pulse waveforms available with some direct pressure monitoring instruments. Visual determination of pulse pressure and character can be used when appropriate vascular beds are exposed during surgical procedures (e.g., laparotomy). Central venous pressure can be used as a direct measure of preload and indirect measure of myocardial function but is not widely reported in the literature.

Cardiovascular support during surgery includes maintenance of body temperature, administration of fluids, maintenance of adequate ventilation, and use of agents to alter blood pH, heart rate, rhythm, and blood pressure. In our experience, routine procedures of short-to-moderate duration incorporate an IV fluid administration rate of at least 10 ml/kg/h. Administration rates reported during neurosurgical procedures are 4 ml/kg/h (Hindman et al., 1990; Lockhart et al., 1991; Mills et al., 1987). While drug doses used for cardiovascular support are usually extrapolated from those used in other species, dosages of vasopressors specific for the rabbit have been reported (Dorward et al., 1987; Patel and Mutch, 1990; Ruta and Mutch, 1989).

IX. POSTOPERATIVE CONSIDERATIONS

“Every anesthetic is a form of physiologic trespass, and the anesthetist must always consider the effects his drugs will produce on body homeostasis” (Holland, 1973). Cardiopulmonary function should continue to be monitored during recovery into the postoperative period. Hypostatic pulmonary congestion should be avoided by altering the rabbit’s position from left to right lateral recumbency every 15 minutes during anesthetic recovery.

As in other species, thermal support is critical during recovery. This is especially important in the rabbit, because of its relatively small size and high surface area/body weight ratio, and the hypothermic effects of most anesthetics. Rectal temperature should be monitored regularly during recovery. Thermal support consisting of circulating hot water blankets, hot water bottles, the Bair Hugger patient thermal warming system, hydrocollator packs, sodium acetate heat packs, microwavable heat packs, infant incubators, ICU cages, warming lamps, and/or blankets should be used to maintain body temperature. Rectal temperature should continue to be monitored for 7–10 days postsurgery to aid in the detection of infection.

Nutritional and fluid support may be necessary postoperatively. Isotonic fluids should be administered especially if there is significant fluid loss during surgery. To minimize hypothermia, fluids can be warmed before administration using a fluid warmer, microwave oven, or incubator. The maintenance fluid requirement of the rabbit is reported as 100 ml/kg/day (Hillyer, 1992). Fluids can be administered subcutaneously, intravenously, or intraperitoneally.

Rabbits recovering from anesthesia may be lightly wrapped in a blanket or towel (burrito style) with the legs flexed against the body to prevent thrashing and damage to the spinal column. Postoperative rabbits with accessible sutures may be fitted with an Elizabethan or cervical collar for the first postoperative week to prevent inadvertent suture removal. In most cases, problems can be avoided by use of a subcuticular closure together with use of a buried knot (Mehler, 2006).

Rabbits are prone to hypoglycemia because of high metabolic rates and, in neonates, limited fat reserves. They should be allowed access to a nutritious pelleted diet soon after surgery as feasible. Anorexic animals can be given 5% dextrose solution SC, 50% dextrose orally, parenteral nutritional support through a stomach or nasoesophageal tube; offered palatable supplements such as hay, alfalfa cubes, or dandelions; and/or administered high-calorie nutritional supplements such as Nutrical® per os (Hillyer, 1992; Reed et al., 1987). Persistent untreated anorexia causes fat mobilization and often leads to irreversible fatal hepatic lipidosis. The oral administration of probiotics such as *Lactobacillus* culture or a slurry of feces or cecal contents from healthy rabbits has been promulgated to return the gastrointestinal flora to normal following gastrointestinal surgery or the administration of flora-altering antibiotics (Gillett et al., 1983; Reed, 1990). To minimize the risk of ileus after abdominal surgery, motility modifiers such as metoclopramide, cisapride, or ranitidine can be administered.

- Dosage recommendations are 0.5 mg/kg cisapride SC, two or three times daily (Paul-Murphy and Ramer, 1998); metoclopramide 0.2–0.5 mg/kg PO or SC, one to three times daily (Carpenter et al., 1995; Messonnier, 1996); and ranitidine 2–5 mg/kg PO, twice daily (Kounenis et al., 1992).

Antibiotics may be necessary following select surgical procedures. They should not be used indiscriminately or as a substitute for aseptic technique. Clostridial enterotoxemia has been associated with the administration of a wide variety of antibiotics (Carman and Evans, 1984). Surgical sites should be evaluated daily for dehiscence, infection, and fluid accumulation. Nonabsorbable suture materials or staples should be removed as soon as wound healing permits, to avoid their serving as a nidus of infection.

Analgesics should be used routinely postoperatively to reduce or eliminate pain or discomfort. Agents should be selected based on the intensity and nature of the stimulus. The following section should be consulted for detailed information.

X. ANALGESIA

A. Pain Assessment

Recognition and accurate assessment of pain intensity, location, and cause is essential if effective therapy is to be instituted. As with other animal species, our understanding of pain expression and pain-related behavior in rabbits is limited. Nevertheless, some attempt to assess pain should be made.

In common with several other species, rabbits experiencing pain may reduce their food and water consumption and, as a consequence, lose weight. Failure to groom may result in the coat becoming ruffled and unkempt, because of the buildup of shed hair that would normally be removed by grooming. Behavioral changes associated with pain often include reduced activity, and almost complete immobility in animals in severe pain. The limited information available indicates that in some animals following abdominal surgery, contractions of the abdominal muscles and pressing of the abdomen ventrally to the ground may indicate the presence of pain. If these are noted, then additional pain relief should be administered. Guarding behavior may be seen, although frequently this is manifested as an escape reaction, or a generalized tensing of muscles with a rigid feel to the trunk and limbs. Since this behavior also occurs in rabbits which are frightened or apprehensive, it is important to obtain an accurate history of any experimental procedures and their possible impact on the animal. It is also helpful to discuss the rabbit's normal behavior with the animal's regular caretaker. Because the response of many rabbits to an unfamiliar handler is to remain immobile, assessment of the animal's behavior may be best carried out by using a video camera, or via an observation panel to view the animal in its cage or pen.

Before initiating a procedure that is likely to cause pain, for example, a surgical operation, it is important to assess and record the rabbit's normal behavior, growth rate, and food and water consumption. Observations made following the procedure can then be made, and the influence of analgesic treatment can then be assessed. Careful observation of the responses to a particular research procedure can be used to formulate a pain scoring system specifically tailored for that procedure. This approach is likely to be considerably more successful than the use of a generalized scoring system.

B. Selection of Analgesics

A range of compounds are available to provide pain relief in the rabbit. However, since this species is less widely used than rodents in the development of new analgesics, relatively limited pharmacokinetic and pharmacodynamic data are available. Some data concerning the use of analgesics in rabbits are available, but these are primarily results from analgesiometric tests. Several different methods of analgesiometry have been

used in rabbits. Thermal stimuli have been applied to the muzzle (Zhou et al., 1981), ear (McCallister et al., 1986; Piercey and Schroeder, 1980; Wynn et al., 1984), or skin (Flecknell and Liles, 1990) using a radiant heat source. Electrical stimulation of the ears (Ayhan et al., 1983) or of the tooth pulp (Mattila and Saarnivaara, 1968) has also been used. Use of pressure on the hindlimb was described by Lightowler and Smith (1963). In all of these tests, the noxious stimulus is applied until the rabbit makes a defined response, for example, a skin twitch when radiant heat is applied to the skin, or a chewing response to electrical stimulation of the tooth pulp. Changes in the response threshold after administration of an analgesic are used to determine the potency of the agent. These analgesiometric tests are most useful for assessing the action of opioids and nonsteroidal anti-inflammatory drugs (NSAIDs) are relatively ineffective (Taber, 1974). Tests equivalent to the inflamed paw pressure test, used in rodents to assess the efficacy of NSAIDs, do not appear to have been developed in the rabbit.

When basing recommendations on data obtained using analgesiometry, it is important to appreciate that the severity of the painful stimuli used may vary considerably, and may also be qualitatively different from postsurgical pain. The potency of different analgesics assessed using analgesiometry correlates well with their potency in man, but the doses used to control clinical pain may vary considerably. At present, it can only be noted that dose rates established using analgesiometry provide a safe starting point for clinical use of the agent. Adjustment of the doses used requires the development of reliable methods of postoperative pain assessment. Where no data concerning particular analgesics are available for the rabbit, extrapolations have been made from data obtained in other species, or recommendations have been made based simply on clinical experience. The source of each recommendation for analgesics use is made clear in the following section.

Opioid analgesics can be used both to provide intraoperative analgesia in rabbits, and to provide postoperative pain relief. The efficacy of a range of agents has been assessed using analgesiometry (McCallister et al., 1986; Piercey and Schroeder, 1980; Wynn et al., 1984) (Table 11-2), and these data can be used to formulate dose rates for treatment of clinical pain (Table 11-3). The mixed agonist/antagonist opioids butorphanol, pentazocine, and nalbuphine, and the partial agonist buprenorphine cause either no respiratory depression or only a minor depression of respiratory rate, which is unlikely to be of clinical significance (Flecknell and Liles, 1990). Buprenorphine administered at a dose of 0.03 mg/kg IV was shown to produce over 10 hours of analgesia by using thermal stimulus analgesiometry (Flecknell and Liles, 1990). Its onset of action is 30 minutes, therefore, it should be administered intraoperatively or prior to recovery from anesthesia when needed for postoperative pain relief. Buprenorphine is the authors' analgesic of choice for control of postoperative pain of moderate intensity. Fentanyl and other μ agonists can cause marked respiratory depression, and depress the respiratory center's responses to CO₂ (Brown

TABLE 11-2
ANALGESIC DOSE RATES IN RABBITS, ASSESSED USING EXPERIMENTAL ANALGESIOMETRY OR RELATED ANIMAL MODELS

Drug	Test	Dose range	References
Opioids			
Alfentanil	Electrical	0.03 mg/kg IV	Wynn et al., 1984
Buprenorphine	Thermal	0.0075 mg/kg–0.3 mg/kg IV	Flecknell and Liles, 1990
Butorphanol	Thermal	0.1–1.5 mg/kg IV	Flecknell and Liles, 1990
Codeine	Electrical	35–70 mg/kg SC, 280–560 mg/kg per os	Leaders and Keasling, 1962
Fentanyl	Electrical	0.0074 mg/kg IV	Wynn et al., 1984
Methadone	Electrical	0.1–5.0 mg/kg IV	Piercey and Schroeder, 1980
Morphine	Electrical	1.25–10 mg/kg IV	Murai and Ogura, 1978
	Electrical	1.0–20.0 mg/kg SC	Ayhan et al., 1983
	Electrical	1.1 mg/kg IV	Wynn et al., 1984
Nalbuphine	Thermal	1.0–10.0 mg/kg IV	Flecknell and Liles, 1990
Pentazocine	Thermal	1.0–5.0 mg/kg IV	Flecknell and Liles, 1990
	Electrical	1–4 mg/kg IV	Murai and Ogura, 1978
	Electrical	8.2 mg/kg IV	Wynn et al., 1984
NSAIDs			
Aspirin	Electrical	1–20 mg/kg SC	Ayhan et al., 1983
Flunixin	Reduction in inflammation	1.1 mg/kg IM	More et al., 1989
Piroxicam	Reduction in inflammation	0.1–0.2 mg/kg per os	More et al., 1989
<i>Miscellaneous</i>			
Baclofen	Electrical	1.5–12 mg/kg IV	Piercey and Schroeder, 1980
Mefenamic acid	Electrical	200 mg/kg per os	Murai and Ogura, 1978
Nefopam	Electrical	1.5–12 mg/kg IV	Piercey and Schroeder, 1980

TABLE 11-3
SUGGESTED DOSE RATES OF ANALGESICS FOR CLINICAL USE IN THE RABBIT

Analgesic	Dose rate	References
Acetaminophen (with or without codeine)	1 ml drug/100 ml drinking water	Wixson, 1994
Buprenorphine	0.01–0.05 mg/kg SC, IV 6–12 hourly	Flecknell and Liles, 1990
Butorphanol	0.1–0.5 mg/kg IV, 4 hourly	Flecknell and Liles, 1990
Carprofen	5 mg/kg SC or PO, daily	Orr et al., 2005
Flunixin	1.1 mg/kg IM, ? 12 hourly	More et al., 1989
Meloxicam	0.3–0.6 mg/kg SC or PO, daily	Parga, 2003; Turner et al., 2006
Meperidine	5–10 mg/kg SC, 2–3 hourly	Flecknell, clinical experience
Methadone	1 mg/kg IV	Piercey and Schroeder, 1980
Morphine	2.5 mg/kg SC, 2–4 hourly	Flecknell, clinical experience; Murai and Ogura, 1978
Nalbuphine	1–2 mg/kg IV, 4–5 hourly	Flecknell and Liles, 1990
Pentazocine	5 mg/kg IV, 2–4 hourly	Flecknell and Liles, 1990
Piroxicam	0.2 mg/kg per os, 8 hourly	More et al., 1989

et al., 1980; Hunter et al., 1968; Pleuvry and Rees, 1969). The clinical significance of some of this data is difficult to interpret since the rabbits studied are likely to have had a marked tachypnea induced by the stress associated with handling and restraint. The pharmacokinetics of fentanyl have been investigated in detail in the rabbit (Hess et al., 1971, 1972). A dose of 20 μ g/kg IV produced an analgesic effect for approximately 30 minutes. The pharmacokinetic data published by these authors enables the calculation of continuous IV infusion regimens of fentanyl in the rabbit. Use of fentanyl patches has been described

in rabbits but clinical efficacy has not been evaluated in any of the controlled trials (Foley et al., 2001).

Authors' Preference	
Agent	Buprenorphine
Route	SC or IV
Dose	0.01–0.05 mg/kg
Comments	An opioid analgesic (partial μ agonist) useful for treating postoperative pain of moderate intensity.

Morphine has been shown to produce hypertension and hyperglycemia in conscious rabbits (May et al., 1988), as a consequence of increased sympathetic activity, and moderate histamine release. Meperidine (Pethidine) (4–16 mg/kg) and pentazocine (2–8 mg/kg) have been reported to cause convulsions in rabbits after IV administration (Hunter et al., 1968) although in a subsequent report it is unclear whether true convulsions were produced (Hunter, 1968). Doses of 1–5 mg/kg of pentazocine IV (Flecknell and Liles, 1990) and pethidine (5–10 mg/kg SC) (Flecknell, clinical experience) did not cause any visible undesirable reactions. Pentazocine at these dose rates produced analgesia assessed using thermal analgesiometry. Administration of the potent μ opioids fentanyl, alfentanil, and sufentanil can produce muscle rigidity unless suitable sedatives and/or tranquilizers are administered simultaneously (Borkowski et al., 1990; Flecknell, unpublished observations). Even after administration of sedatives, these undesirable side effects may still be encountered (Marini et al., 1993). It is therefore recommended that these potent μ opioids are administered only as adjuncts to general anesthetics, or in well-characterized neuroleptanalgesic combinations. Morphine has been reported to produce sedation in rabbits (May et al., 1988), as have butorphanol, pentazocine and nalbuphine (Flecknell and Liles, 1990). Detailed studies of the effects of opioids on behavior in rabbits have not been undertaken, so their nonspecific effects on pain scoring remain to be established.

The efficacy of orally administered morphine and codeine has been investigated by Leaders and Keasling (1962), using a tooth pulp stimulation model. In comparison to subcutaneous administration, approximately a 10-fold increase in oral dosage was required to have an equivalent analgesic effect. Despite their poor bioavailability, oral codeine or morphine might provide a useful mean of providing pain relief in rabbits if palatability issues could be overcome.

There appear to be no published clinical trials of the use of opioids to control postoperative pain in rabbits. Clinical experience in our laboratory suggests that a variety of opioids can be useful (see Table 11-2), but detailed studies using pain-scoring techniques are urgently required. In our experience, use of buprenorphine (0.05 mg/kg) has not resulted in any problems associated with reduced gut motility. Since pain is a potential cause of gut stasis in rabbits, the beneficial effects of opioids outweigh any potential side effects.

There are no reports of use of Tramadol, a synthetic μ -receptor opiate agonist, in rabbits; however, it is becoming more widely used in other species. The pharmacokinetics of this agent have been described, but its analgesic potency has not been established (Kucuk et al., 2005).

The use of NSAIDs in laboratory species has been reviewed by Liles and Flecknell (1992) and only limited data concerning the use of these agents in the rabbit appears to have been published.

Meloxicam and carprofen have both been widely used in rabbits kept as companion animals, and both have been used in

large-scale clinical trials with no clinically apparent adverse effects (Orr et al., 2005; Parga et al., 2003). Oral meloxicam has been administered to laboratory rabbits at doses ranging from 0.3 to 1.5 mg/kg daily for 5 days with no adverse effects (Turner et al., 2006). This latter study suggested that doses in excess of 0.3 mg/kg may be required to maintain effective analgesia.

Piroxicam (0.1 and 0.2 mg/kg PO every 8 hours) and flunixin (1.1 mg/kg IM) were shown to be effective in reducing limb swelling in an experimental fracture model in rabbits (More et al., 1989), but no attempt was made to assess the analgesic effects of these compounds. Of particular clinical relevance, however, was the finding that both flunixin and piroxicam reduced tissue swelling without affecting the strength of the healed fracture. No animals were reported to develop adverse reactions during the 3-week treatment period in this study, although it is stated that in a pilot study, aspirin was found to be poorly tolerated by rabbits. Unfortunately no details of the dose rate used or the problems encountered were described.

Aspirin has been used clinically in rabbits, but no controlled trials have been carried out to monitor its toxicity or efficacy in this species. A dose of 10 mg/kg SC had a detectable analgesic effect in a tooth pulp assay (Ayhan et al., 1983), and doses over 300 mg/kg IV were lethal (Piercey and Schroeder, 1980). Ketoprofen administered for 8 days (3 mg/kg IV) produced no signs of renal toxicity, but affected renal prostaglandin synthesis (Perrin et al., 1990). Aspirin (10 mg/kg SC) was effective in an electrical stimulation model (Ayhan et al., 1983), but was relatively ineffective, even in high doses in other pain models (Murai and Ogura, 1978; Piercey and Schroeder, 1980). It is important to note that NSAIDs generally are relatively ineffective in standard analgesiometric tests, and data from tests which more effectively predict the clinical efficacy of NSAIDs (e.g., the inflamed paw pressure test), appear to be unavailable for the rabbit. As with the opioids, there appear to be no published clinical trials of NSAIDs in rabbits, and the suggested dose rates in Table 11-2 require validation using a pain scoring system.

Acetaminophen with and without codeine has been anecdotally reported to have mild analgesic effect of short duration when administered orally to rabbits (Wixson, 1994). Palatability is markedly enhanced by using grape- or cherry-flavored acetaminophen or fruit flavored acetaminophen-codeine suspension. The recommended dose of either product is 1 ml drug/100 ml water (Wixson, 1994).

Local anesthetics such as lidocaine and bupivacaine can be used to provide local anesthesia and pain relief in rabbits either by local infiltration of surgical wounds or by spinal anesthesia. Topical ophthalmic anesthetics can be used to produce anesthesia of the cornea in rabbits.

Corticosteroids can be used to reduce tissue inflammation and hence pain in rabbits. Dose rates must be obtained by extrapolation from other species.

The α -2 agonists, xylazine and medetomidine, have been extensively used as adjuncts to ketamine anesthesia in rabbits.

Their utility as analgesics is limited since they are relatively short-acting and produce profound sedation.

REFERENCES

- Adams, H.J., Mastro, A.R., Eischolzer, A.W., and Kilpatrick, G. (1974). Morphologic effects of intrathecal etidocaine and tetracaine on the rabbit spinal cord. *Anesth. Analg.* **53**, 904–908.
- Adam, H.K., Glen, J.B., and Hoyle, P.A. (1980). Pharmacokinetics in laboratory animals of ICI 35 868, a new I.V. anaesthetic agent. *Br. J. Anaesth.* **52**, 743–746.
- Aeschbacher, G., and Webb, A.I. (1993a). Propofol in rabbits. 1. Determination of an induction dose. *Lab. Anim. Sci.* **43**, 324–327.
- Aeschbacher, G., and Webb, A.I. (1993b). Propofol in rabbits. 2. Long-term anesthesia. *Lab. Anim. Sci.* **43**, 328–335.
- Alberius, P., Klinge, B., and Isaksson, S. (1989). Management of craniotomy in young rabbits. *Lab. Anim. (Lond.)* **23**, 70–73.
- Alexander, D.J., and Clark, G.C. (1980). Simple method of oral endotracheal intubation in rabbits (*Oryctolagus cuniculus*). *Lab. Anim. Sci.* **30**, 871–873.
- Antal, M. (1985). Ultrastructural changes of the rabbit retina following methohexital anaesthesia. *Acta Morphol. Hung.* **33**, 13–19.
- Arnolda, L., McGrath, B., Cocks, M., Sumithran, E., and Johnston, C. (1985). Adriamycin cardiomyopathy in the rabbit: An animal model of low output cardiac failure with activation of vasoconstrictor mechanisms. *Cardiovasc. Res.* **19**, 378–382.
- Artru, A.A., and Momota, Y. (1999). Trabecular outflow facility and formation rate of aqueous humor during anesthesia with sevoflurane-nitrous oxide or sevoflurane-remifentanyl in rabbits. *Anesth. Analg.* **88**, 781–786.
- Avsaroglu, H., Versluis, A., Hellebrekers, L.J., Haberham, Z.L., van Zutphen, L.F., and van Lith, H.A. (2003). Strain differences in response to propofol, ketamine, and medetomidine in rabbits. *Vet. Rec.* **152**, 300.
- Ayhan, I.H., Turker, R.K., and Melli, M. (1983). A new method for the rapid measurement of analgesic activity in rabbits. *Arch. Int. Pharmacodyn. Ther.* **262**, 215–220.
- Bateman, L., Ludders, J.W., Gleed, R.D., and Erb, H.N. (2005). Comparison between facemask and laryngeal mask airway in rabbits during isoflurane anesthesia. *Vet. Anaesth. Analg.* **32**, 280–288.
- Baum, M., Putz, G., Mutz, N., Putinsen, C., Klima, G., and Benzer, H. (1989). Influence of high frequency ventilation at different end-expiratory lung volumes on the development of lung damage during lung lavage in rabbits. *Br. J. Anaesth.* **63**, 615–705.
- Beaudoin, S., Simon, L., Simeoni, J., Sacquin P., and Bary, F. (1998). Surgical approach of an early mammalian embryo: the rabbit model. *Fetal Diagn. Ther.* **13**, 82–85.
- Bernards, C.M., and Artru, A.A. (1991). Hexamethonium and midazolam terminate dysrhythmias and hypertension caused by intracerebroventricular bupivacaine in rabbits. *Anesthesiology* **74**, 89–96.
- Bertolet, R.D., and Hughes, H.C. (1980). Endotracheal intubation: An easy way to establish a patent airway in rabbits. *Lab. Anim. Sci.* **30**, 227–230.
- Betteridge, K.J. (1973). Simple and inexpensive apparatus for halothane anaesthesia in rabbits and other small animals. *Vet. Rec.* **93**, 398–399.
- Beyers, T.M., Richardson, J.A., and Prince, M.D. (1991). Axonal degeneration and self-mutilation as a complication of the intramuscular use of ketamine and xylazine in rabbits. *Lab. Anim. Sci.* **41**, 519–520.
- Bieter, R.N., Cunningham, R.W., Lenz, O., and McNearny, J.J. (1936). Threshold anesthetic and lethal concentrations of certain spinal anesthetics in the rabbit. *J. Pharmacol. Exp. Ther.* **57**, 221–244.
- Bivin, W.S., and Timmons, E.H. (1974). Anesthesiology. In “The Biology of the Laboratory Rabbit.” (S.M. Weisbroth, R.E. Flatt, and A.L. Kraus, eds.), pp 77–83. Academic Press Inc., Orlando, FL.
- Blake, D.W., Jover, B., and McGrath, B.P. (1988). Haemodynamic and heart rate reflex responses to propofol in the rabbit. *Br. J. Anaesth.* **61**, 194–199.
- Blake, D.W., Way, D., Trigg, L., Langton, D., and McGrath, B.P. (1991). Cardiovascular effects of volatile anesthesia in rabbits: Influence of chronic heart failure and enalaprilat treatment. *Anesth. Analg.* **73**, 441–448.
- Bonath, K., Nolte, I., Schniewind, A., Sandmann, H., and Failing, K. (1982). Food deprivation as precaution and aftercare measure for anaesthesia: The influence of fasting on the acid base status and glucose concentration in the blood of rabbits. *Berl. Mun. Tierarztl. Wochenschr.* **95**, 126–130.
- Booth, N.H., and McDonald, L.E. (eds.). (1988). “Veterinary Pharmacology and Therapeutics,” 6th ed. Iowa State University Press, Ames, IA.
- Borkowski, G.L., Danneman, P.J., Russell, G.B., and Lang, C.M. (1990). Evaluation of three intravenous anesthetic regimens in New Zealand rabbits. *Lab. Anim. Sci.* **40**, 270–276.
- Boucher, M.C., and Meyers, E. (1983). Effects of nitrous oxide anesthesia on intraocular air volume. *Can. J. Ophthalmol.* **18**, 246–247.
- Brammer, D.W., Doerning, B.J., Chrisp, C.E., and Rush, H.G. (1991). Anesthetic and nephrotoxic effects of Telazol® in New Zealand White rabbits. *Lab. Anim. Sci.* **41**, 432–435.
- Bree, M.M., and Cohen, B.J. (1965). Effects of urethane anesthesia on blood and blood vessels in rabbits. *Lab. Anim. Care* **15**, 254–259.
- Bree, M.M., Cohen, B.J., and Abrams, G.D. (1971). Injection lesions following intramuscular administration of chlorpromazine in rabbits. *J. Am. Vet. Med. Assoc.* **159**, 1598–1602.
- Brown, J.H., Pleuvry, B.J., and Kay, B. (1980). Respiratory effects of a new opiate analgesic, R39209, in the rabbit: Comparison with fentanyl [R39209 = alfentanil]. *Br. J. Anaesth.* **52**, 1104–1106.
- Carman, R.J., and Evans, R.H. (1984). Experimental and spontaneous clostridial enteropathies of laboratory and free living lagomorphs. *Lab. Anim. Sci.* **34**, 443–452.
- Carpenter, J.W., Mashima, N.Y., Gentz, E.J., and Harrenstien L. (1995). Caring for rabbits: An overview and formulary. *Vet. Med.* **90**, 340–364.
- Chakrabarty, S., Thomas, P., and Sheridan, D.J. (1991). Arrhythmias, haemodynamic changes and extent of myocardial damage during coronary ligation in rabbits anesthetized with halothane, alpha chloralose or pentobarbitone. *Int. J. Cardiol.* **31**, 9–14.
- Chen, G., and Bohner, B. (1968). Surgical anesthesia in the rabbit with 2-(ethylamino)-2-(2-Thienyl) cyclohexanone_ HCl (CI-634) and chloral hydrate. *Am. J. Vet. Res.* **29**, 869–875.
- Chen, W.H., Lee, C.Y., Hung, K.C., Yeh, F.C., Tseng, C.C., and Shiau, J.M. (2006). The direct cardiac effect of propofol on intact isolated rabbit heart. *Acta Anaesthesiol. Taiwan* **44**, 19–23.
- Clifford, D.H. (1984). Preanesthesia, anesthesia, analgesia and euthanasia. In “Laboratory Animal Medicine.” (J.G. Fox, B.J. Cohen, and F.M. Loew, eds.), pp 543–545. Academic Press Inc., Orlando, FL.
- Cockshott, T.D., Douglas, E.J., Plummer, G.F., and Simons, P.J. (1992). The pharmacokinetics of propofol in laboratory animals. *Xenobiotica* **22**, 369–375.
- Coderre, T.J., Katz, J., Vaccarino, A.L., and Melzack, R. (1993). Contribution of central neuroplasticity to pathological pain: review of clinical and experimental evidence. *Pain* **52**, 259–285.
- Conn, H., and Langer, R. (1978). Continuous long-term intra-arterial infusion in the unrestrained rabbit. *Lab. Anim. Sci.* **28**, 598–602.
- Cope, D.K., Impastato, W.K., Cohen, M.V., and Downey, J.M. (1997). Volatile anesthetics protect the ischemic rabbit myocardium from infarction. *Anesthesiology* **86**, 699–709.
- Cowen, R.H., and Laurensen, R.D. (1959). Technique of operating upon the fetus of the rabbit. *Surgery* **45**, 321–323.
- Crawford, M.E., Jensen, F.M., Toftdahl, D.B., and Madsen, J.B. (1993). Direct spinal effect of intrathecal and extradural midazolam on visceral noxious stimulation in rabbits. *Br. J. Anaesth.* **70**, 642–646.
- Danneman, P.J., White, W.J., Marshall, W.K., and Lang, C.M. (1988). Evaluation of analgesia associated with the immobility response in laboratory rabbits. *Lab. Anim. Sci.* **38**, 51–56.
- Davis, J.A., Greenfield, R.E., and Brewer, T.G. (1993). Benzocaine-induced methemoglobinemia attributed to topical application of the anesthetic in several laboratory animal species. *J. Am. Vet. Med. Assoc.* **54**, 1322–1326.

- Davis, N.L., and Malinin, T.I. (1974). Rabbit intubation and halothane anesthesia. *Lab. Anim. Sci.* **24**, 617–621.
- DeCastro, G., and Viars, P. (1968). Anesthetic analgesique sequentielle, on A.A.S. *Arch. Med.* **23**, 170–176.
- Deimling, M.J., and Schnell, R.C. (1980). Circadian rhythms in the biological response and disposition of ethanol in the mouse. *J. Pharmacol. Exp. Ther.* **213**, 1–8.
- Demirel, E., Ugur, H.C., Dolgun, H., Kahilogullari, G., Sargon, M.E., Egemen, N., and Kecik, Y. (2006). The neurotoxic effects of intrathecal midazolam and neostigmine in rabbits. *Anaesth. Intensive Care* **34**, 218–223.
- DeMulder, P.A., Van Kerckhoven, R.J., Adriaensen, H.F., Gillebert, T.C., and De Hert, S.G. (1997). Continuous total intravenous anesthesia, using propofol and fentanyl in an open-thorax rabbit model: Evaluation of cardiac contractile function and biochemical assessment. *Lab. Anim. Sci.* **47**, 367–375.
- Dhasmana, K.M., Saxena, P.R., Prakash, O., and Van Der Zee, H.T. (1984). Study on the influence of ketamine on systemic and regional haemodynamics in conscious rabbits. *Arch. Int. Pharmacodyn. Ther.* **269**, 323–334.
- Difilippo, S.M., Norberg, P.J., Suson, U.D., Savino, A.M., and Reim, D.A. (2004). A comparison of xylazine and medetomidine in an anesthetic combination in New Zealand White Rabbits. *Contemp. Top. Lab. Anim. Sci.* **43**, 32–34.
- Doerning, B.J., Brammer, D.W., Chrisp, C.E., and Rush, H.G. (1992). Nephrotoxicity of tiletamine in New Zealand White rabbits. *Lab. Anim. Sci.* **42**, 267–269.
- Dollo, G., LeCorre, P., Chevanne, F., and Le Verge, R. (2004a). Bupivacaine containing dry emulsion can prolong epidural anesthetic effects in rabbits. *Eur. J. Pharm. Sci.* **22**, 63–70.
- Dollo, G., Malinovsky, J.M., Peron, A., Chevanne, F., Pinaud, M., Le Verge, R., and Le Corre, P. (2004b). Prolongation of epidural bupivacaine effects with hyaluronic acid in rabbits. *Int. J. Pharm.* **272**, 109–119.
- Dolowy, W.C., and Hesse, A.L. (1959). Chlorpromazine premedication with pentobarbital anesthesia in the rabbit. *J. Am. Vet. Med. Assoc.* **134**, 183–184.
- Dorward, P.K., Burke, S., Janig, W., and Cassell, J. (1987). Reflex responses to baroreceptor, chemoreceptor and nociceptor inputs in single renal sympathetic neurones in the rabbit and the effects of anaesthesia on them. *J. Auton. Nerv. Syst.* **18**, 39–54.
- Drummond, J.C. (1985). MAC for halothane, enflurane, and isoflurane in the New Zealand White rabbit and a test for the validity of MAC determinations. *Anesthesiology* **62**, 336–338.
- Drummond, J.C., Scheller, M.S., and Todd, M.M. (1987). Effect of nitrous oxide on cortical cerebral blood flow during anesthesia with halothane and isoflurane, with and without morphine, in the rabbit. *Anesth. Analg.* **66**, 1083–1089.
- Dupras, J., Vachon, P., Cuvelliez, S., and Blais, D. (2001). Anesthesia of the New Zealand rabbit using the combination of tiletamine-zolazepam and ketamine-midazolam with or without xylazine. *Can. Vet. J.* **42**, 455–460.
- Durant, P.A.C., and Yaksh, T.L. (1986). Epidural injection of bupivacaine, morphine, fentanyl, lofentanyl and DADL in chronically implanted rats: A pharmacologic and pathologic study. *Anesthesiology* **64**, 43–53.
- Ecobichon, D.J., and Comeau, A.M. (1974). Genetic polymorphism of plasma carboxylesterases in the rabbit: Correlation with pharmacologic and toxicologic effects. *Toxicol. Appl. Pharmacol.* **27**, 28–40.
- Elsa, A., and Ubandawaki, S. (2005). Ketamine anaesthesia following premedication of rabbits with vitamin C. *J. Vet. Sci.* **6**, 239–241.
- Erdine, S., Yucel, A., Ozyalcin, S., Ozyuvaci, E., Talu, G.K., Ahiskali, B., Apak, H., and Savci, N. (1999). Neurotoxicity of midazolam in the rabbit. *Pain* **80**, 419–423.
- Farkas, A., Batey, A.J., and Cokey, S.J. (2004). How to measure electrocardiographic QT interval in the anaesthetized rabbit. *J. Pharmacol. Toxicol. Methods* **50**, 175–185.
- Fick, T.E., and Schalm, S.W. (1986). Procedure for arterial blood sampling in the rabbit. *Lab. Anim. (Lond.)* **20**, 138–139.
- Fick, T.E., and Schalm, S.W. (1987). A simple technique for endotracheal intubation in rabbits. *Lab. Anim. (Lond.)* **21**, 265–266.
- Flecknell, P.A. (1996). “Laboratory Animal Anaesthesia: An Introduction for Research Workers and Technicians,” 2nd ed. Academic Press, London.
- Flecknell, P.A., Cruz, I.J., Liles, J.H., and Whelan, G. (1996). Induction of anaesthesia with halothane and isoflurane in the rabbit: A comparison of the use of a face-mask or an anaesthetic chamber. *Lab. Anim. (Lond.)* **30**, 67–74.
- Flecknell, P.A., John, M., Mitchell, M., Shurey, C., and Simpkin, S. (1983). Neuroleptanalgesia in the rabbit. *Lab. Anim. (Lond.)* **17**, 104–109.
- Flecknell, P.A., and Liles, J.H. (1990). Assessment of the analgesic action of opioid agonist-antagonists in the rabbit. *J. Assoc. Vet. Anaesth.* **17**, 24–29.
- Flecknell, P.A., and Liles, J.H. (1996). Halothane anesthesia in the rabbit: A comparison of the effects of medetomidine, acepromazine and midazolam on breath-holding during induction. *J. Vet. Anaesth.* **23**, 11–14.
- Flecknell, P.A., Liles, J.H., and Williamson, H.A. (1990). The use of lignocaine-prilocaine local anaesthetic cream for pain-free venepuncture in laboratory animals. *Lab. Anim. (Lond.)* **24**, 142–146.
- Flecknell, P.A., Liles, J.H., and Wootton, R. (1989). Reversal of fentanyl/fluanisone neuroleptanalgesia in the rabbit using mixed agonist/antagonist opioids. *Lab. Anim. (Lond.)* **23**, 147–155.
- Flecknell, P.A., and Mitchell, M. (1984). Midazolam and fentanyl-fluanisone: Assessment of anaesthetic effects in laboratory rodents and rabbits. *Lab. Anim. (Lond.)* **18**, 143–146.
- Flecknell, P.A., Roughan, J.V., and Hedenqvist, P. (1999). Induction of anesthesia with sevoflurane and isoflurane in the rabbit. *Lab. Anim. (Lond.)* **33**, 41–46.
- Foley, P.L., Henderson, A.L., Bissonette, E.A., Wimer, G.R., and Feldman, S.H. (2001). Evaluation of fentanyl transdermal patches in rabbits: Blood concentrations and physiologic response. *Comp. Med.* **51**(3), 239–244.
- Freeman, M.J., Bailey, S.P., and Hodesson, S. (1972). Premedication, tracheal intubation, and methoxyflurane anesthesia in the rabbit. *Lab. Anim. Sci.* **22**, 576–580.
- Gardner, A.F. (1964). Development of general anesthesia in the albino rabbit for surgical procedures. *Lab. Anim. Care* **14**, 214–225.
- Gay, W.I. (ed.). (1963). “Methods of Animal Experimentation,” Vol. I. Academic Press, New York.
- Gonzalez-Gil, A.G., Illera, J.C., Silvan, G., Lorenzo, P.L., and Illera, M. (2002). Changes in hepatic and renal enzyme concentrations and heart and respiratory rates in New Zealand white rabbits. *Contemp. Top. Lab. Anim. Sci.* **41**, 30–32.
- Gil, A.G., Silvan, G., Illera, M., and Illera, J.C. (2004). The effects of anesthesia on the clinical chemistry of New Zealand white rabbits. *Contemp. Top. Lab. Anim. Sci.* **43**, 25–29.
- Gil, A.G., Silvan, G., Martinez-Mateos, M.M., and Illera, J.C. (2005). Serum catecholamine levels after halothane and isoflurane anesthesia in rabbits. *Vet. Rec.* **157**, 589–590.
- Gillett, N.A., Brooks, D.L., and Tillman, P.C. (1983). Medical and surgical management of gastric obstruction from a hairball in the rabbit. *J. Am. Vet. Med. Assoc.* **183**, 1176–1178.
- Glen, J.B. (1980). Animal studies of the anaesthetic activity of ICI 35 868. *Br. J. Anaesth.* **52**, 731–741.
- Gografe, S.I., Wilson, J.S., Johnson, B.L., Rushing, G., Bowser, A., Parker, J.L., and Cornelius, C.E. (2003). Successful management of long-term general anesthesia in rabbits used as an animal model of human disease. *Contemp. Top. Lab. Anim. Sci.* **42**, 16–19.
- Goldstein, J.L., Kita, T., and Brown, M.S. (1983). Defective lipoprotein receptors and atherosclerosis. *New Engl. J. Med.* **309**, 288–296.
- Gonzalez-Gil, A., Illera, J.C., Silvan, G., and Illera, M. (2003). Effects of the anaesthetic/tranquillizer treatments on selected plasma biochemical parameters in NZW rabbits. *Lab. Anim. (Lond.)* **37**, 155–161.
- Gonzalez, A.G., Silvan, G. and Illera, J.C. (2005). Effects of barbiturate administration on hepatic and renal biochemical parameters in New Zealand white rabbits. *Contemp. Top. Lab. Anim. Sci.* **44**, 43–45.
- Green, C.J. (1975). Neuroleptanalgesic drug combinations in the anaesthetic management of small laboratory animals. *Lab. Anim. (Lond.)* **9**, 161–178.

- Green, C.J. (1982a). "Animal Anaesthesia." Laboratory Animals Ltd., Essex, England.
- Green, C.J. (1982b). Orders lagomorpha, rodentia, insectivora and chiroptera. In "Animal Anesthesia, Laboratory Animal Handbook," Vol. 8, pp 131–138. Laboratory Animals Ltd., London.
- Green, C.J., Halsey, M.J., Precious, S., and Wardley-Smith, B. (1978). Alphaxalone-alphadolone anaesthesia in laboratory animals. *Lab. Anim. (Lond.)* **12**, 85–89.
- Green, C.J., Knight, J., Precious, S., and Simpkin, S. (1981). Ketamine alone and combined with diazepam or xylazine in laboratory animals: A 10 year experience. *Lab. Anim. (Lond.)* **15**, 163–170.
- Grice, H.C. (1964). Methods for obtaining blood and for intravenous injections in laboratory animals. *Lab. Anim. Care* **14**, 483–493.
- Grint, N.J., Sayers, I.R., Cecchi, R., Harley, R., and Day, M.J. (2005). Postanesthetic tracheal strictures in three rabbits. *Lab. Anim. (Lond.)* **40**, 301–308.
- Gruber, R.P., and Amato, J.J. (1970). Hypnosis for rabbit surgery. *Lab. Anim. Care* **20**, 741–742.
- Guerreiro, D., and Page, C.P. (1987). Effect of neuroleptanalgesia on some cardiorespiratory variables in the rabbit. *Lab. Anim. (Lond.)* **21**, 205–209.
- Hall, L.W., and Clarke, K.W. (1991). "Veterinary Anaesthesia," 9th ed. Baillière Tindall, London.
- Harris, R.H., Jr., and Best, C.F. (1979). Ureteral catheter system for renal function studies in conscious rabbits. *Lab. Anim. Sci.* **29**, 781–784.
- Hartikainen, K., Rorarius, M., Makela, K., Yli-Hankala, A., and Jantti, V. (1995). Propofol and isoflurane induced EEG burst suppression pattern in rabbits. *Acta Anaesthesiol. Scand.* **39**, 814–818.
- Harvey, R.C., and Walberg, J. (1987). Special considerations for anesthesia and analgesia in research animals. In "Principles and Practice of Veterinary Anesthesia." (C. E. Short, ed.), pp 381–382. Williams & Wilkins, Baltimore, MD.
- Hastings, J.W., and Menaker, M. (1976). Physiological and biochemical aspects of circadian rhythms. *Fed. Proc. Am. Soc. Exp. Biol.* **35**, 2325–2357.
- Hayashida, M., Fukunaga, A., and Hanaoka, K. (2003). An animal model for surgical anesthesia and analgesia: characterization with isoflurane anesthesia and remifentanyl analgesia. *Anesth. Analg.* **97**, 1340–1346.
- Hayashida, M., Fukunaga, A., Fukuda, K., Yamazaki, S.Y., Arita, H., and Hanaoka, K. (2004). A rabbit model for evaluation of surgical anesthesia and analgesia: characterization and validation with isoflurane anesthesia and fentanyl analgesia. *J. Anesth.* **18**, 282–291.
- Hedenqvist, P., Roughan, J.V., Antunes, L., Orr, H., and Flecknell, P.A. (2001). Induction of anaesthesia with desflurane and isoflurane in the rabbit. *Lab. Anim. (Lond.)* **35**, 172–179.
- Hedenqvist, P., Orr, H.E., Roughan, J.V., Antunes, L., and Flecknell, P.A. (2002). Anaesthesia with ketamine/medetomidine in the rabbit: Influence of route of injection and the effect of combination with butorphanol. *Vet. Anaesth. Analg.* **29**, 14–19.
- Hellebrekers, L.J., de Boer, E.J., van Zuylen, M.A., and Vosmeer, H. (1997). A comparison between medetomidine-ketamine and medetomidine-propofol anesthesia in rabbits. *Lab. Anim. (Lond.)* **31**, 58–69.
- Henke, J., Astner, S., Brill, T., Eissner, B., Busch, R., and Erhardt, W. (2005). Comparative study of three intramuscular anaesthetic combinations (medetomidine/ketamine, medetomidine/fentanyl/midazolam, and xylazine/ketamine) in rabbits. *Vet. Anaesth. Analg.* **32**, 261–270.
- Henke, J., Koch, M., Brill, T., Bolkart, B., Janczewski, M., and Erhardt, W. (1996). Isoflurane anaesthesia in rabbits in a closed anesthetic system. *Tierarztl. Prax.* **24**, 604–609.
- Hess, R., Herz, A., and Friedel, K. (1971). Pharmacokinetics of fentanyl in rabbits in view of the importance for limiting the effect. *J. Pharmacol. Exp. Ther.* **179**, 474–484.
- Hess, R., Husmann, K., and Kettler, D. (1981). Blood levels of fentanyl during multiple injections and intravenous infusions of low and high doses: Approaching optimal conditions for "stress-free anaesthesia." *Methods Find. Exp. Clin. Pharmacol.* **3**, 107S–114S.
- Hess, R., Stiebler, G., and Herz, A. (1972). Pharmacokinetics of fentanyl in man and the rabbit. *Eur. J. Clin. Pharmacol.* **4**, 137–141.
- Hexeberg, E., Hexeberg, S., Hessevik, I., and Fosse, R.T. (1995). Midazolam in combination with fentanyl/fluanisone and nitrous oxide as anaesthesia in rabbits cardiovascular parameters. *Lab. Anim. (Lond.)* **29**, 400–406.
- Hillyer, E.V. (1992). Approach to the anorexic rabbit. *J. Small Exot. Anim. Med.* **1**, 106–108.
- Hindman, B.J., Funatsu, N., Cheng, D.C.H., Bolles, R., Todd, M.M., and Tinker, J.H. (1990). Differential effect of oncotic pressure on cerebral and extracerebral water content during cardiopulmonary bypass in rabbits. *Anesthesiology* **73**, 951–957.
- Hino, Y., Inoue, H., Kudo, K., Nishida, N., and Ikeda, N. (2001). Distribution of tetracaine and its metabolite in rabbits after high versus normal spinal anesthesia. *Forensic Sci. Int.* **124**, 130–136.
- Hobbs, B.A., Rollhall, T.G., Sprengel, T.L., and Anthony, K.L. (1991). Comparisons of several combinations for anesthesia in rabbits. *Am. J. Vet. Res.* **52**, 669–674.
- Hodesson, S., Rich, S.T., Washington, J.O., and Apt, L. (1965). Anesthesia of the rabbit with Equi-Thesin[®] following the administration of preanesthetics. *Lab. Anim. Care* **15**, 336–337.
- Hogan, Q.H., Amuzu, J., Clifford, P.S., Bosnjak, Z.J., and Kampine, J.P. (1998). Hypoxia causes apnea during epidural anesthesia in rabbits. *Anesthesiology* **88**, 761–767.
- Hoge, R.S., Hodesson, S., Snow, I.B., and Wood, A.I. (1969). Intubation technique and methoxyflurane administration in rabbits. *Lab. Anim. Care* **19**, 593–595.
- Holland, A.J.C. (1973). Laboratory animal anaesthesia. *Can. Anaesth. Soc. J.* **20**, 693–705.
- Horita, A., and Carino, M.A. (1978). Analeptic and antianaleptic effects of naloxone and naltrexone in rabbits. *Life Sci.* **23**, 1681–1686.
- Horita, A., Carino, M.A., and Yamawaki, S. (1983). Morphine antagonizes pentobarbital-induced anesthesia. *Neuropharmacology* **22**, 1183–1186.
- Hovav, E., and Weinstock, M. (1987). Temporal factors influencing the development of acute tolerance to opiates. *J. Pharmacol. Exp. Ther.* **242**, 251–256.
- Howard, D.L., Wittry, J.P., and Blum, J.R. (1990). Use of an audible respiratory monitor to aid endotracheal intubation of the rabbit [abstract P22]. *Lab. Anim. Sci.* **40**, 562–563.
- Hughes, P.J., Doherty, M.M., and Charman, W.N. (1993). A rabbit model for the evaluation of epidurally administered local anaesthetic agents. *Anaesth. Intensive Care* **21**, 298–303.
- Hunter, A.R. (1968). The respiratory effects of pentazocine in rabbits. *Anesthesia* **23**, 338–342.
- Hunter, A.R., Pleuvry, B.J., and Rees, J.M.H. (1968). The respiratory depressant effects of barbiturates and narcotic analgesics in the unanaesthetised rabbit. *Br. J. Anaesth.* **40**, 927–935.
- Hurley, R.J., Marini, R.P., Avison, D.L., Murphy, J.C., Olin, J.M., and Lipman, N.S. (1994). Evaluation of detomidine anesthetic combinations in the rabbit. *Lab. Anim. Sci.* **44**, 472–478.
- Illera, J.C., Gonzalez-Gil, A., Silvan, G., and Illera, M. (2000). The effects of different anaesthetic treatments on the adreno-cortical functions and glucose levels in NZW rabbits. *J. Physiol. Biochem.* **56**, 329–336.
- Imai, A., Steffey, E.P., Ilkiw, J.E., and Farver, T.B. (1999). Comparison of clinical signs and hemodynamic variables used to monitor rabbits during halothane- and isoflurane-induced anesthesia. *Am. J. Vet. Res.* **60**, 1189–1195.
- Imai, A., Eisele, P.H., and Steffey, E.P. (2005). A new airway device for small laboratory animals. *Lab. Anim. (Lond.)* **39**, 111–115.
- Irazuzta, J., Hopkins, J., Gunnoe, P., and Brittain, E. (1997). Simple method of multipurpose airway access through percutaneous tracheostomy in rabbits (*Oryctolagus cuniculus*). *Lab. Anim. Sci.* **47**, 411–413.
- Ishibe, Y., Gui, X., Uno, H., Shiokawa, Y., Umeda, T., and Suekane, K. (1993). Effect of sevoflurane on hypoxic pulmonary vasoconstriction in the perfused rabbit lung. *Anesthesiology* **79**, 1348–1353.
- Jacobs, R., and Krohn, D.L. (1975). Anesthesia in rabbits by intrahepatic sodium pentobarbital. *J. Surg. Res.* **19**, 115–119.

- Jenkins, W.L. (1987). Pharmacologic aspects of analgesic drugs in animals: An overview. *J. Am. Vet. Med. Assoc.* **191**, 12231–1240.
- Jensen, F.M., Dahl, J.B., and Frigast, C. (1992). Direct spinal effect of intrathecal acetaminophen on visceral noxious stimulation in rabbits. *Acta Anaesthesiol. Scand.* **36**, 837–841.
- Ji, F., Huang, F., Juhasz, A., Wu, W., and Bodor, N. (2000). Design, synthesis, and pharmacological evaluation of soft glycopyrrolate and its analog. *Pharmazie* **55**, 187–191.
- Johnson, N.F., Strang, R., and Wilson, T.M. (1973). Further observations on the retinal fine structure after long-term anaesthesia. *Exp. Eye Res.* **17**, 73–85.
- Jori, A., DiSalle, E., and Santini, V. (1971). Daily rhythmic variation and liver drug metabolism in rats. *Biochem. Pharmacol.* **29**, 2965–2969.
- Kaplan, H. M., and Timmons, E. H. (1979). "The Rabbit: A Model for the Principles of Mammalian Physiology and Surgery." Academic Press, New York.
- Katsuda, S., Waki, H., Nagayama, T., Yamasaki, M., H, O. I., Katahira, K., and Shimizu, T. (2000). Time-dependent change in baroreflex control capacity of arterial pressure by pentobarbital anesthesia in rabbits. *Exp. Anim.* **49**, 111–118.
- Kent, G.M. (1971). General anesthesia in rabbits using methoxyflurane, nitrous oxide, and oxygen. *Lab. Anim. Sci.* **21**, 256–257.
- Kero, P., Thomasson, B., and Soppi, A.-M. (1981). Spinal anaesthesia in the rabbit. *Lab. Anim. (Lond.)* **15**, 347–348.
- Kim, M.S., Jeong, S.M., Park, J.H., Nam, T.C., and Seo, K.M. (2004). Reversal of medetomidine-ketamine combination anesthesia in rabbits by atipamezole. *Exp. Anim.* **53**, 423–428.
- Kim, Y.C., Lim, Y.J., and Lee, S.C. (1998). Spreading pattern of epidurally administered contrast medium in rabbits. *Acta Anaesthesiol. Scand.* **42**, 1092–1095.
- Klemm, W.R. (1965). Drug potentiation of hypnotic restraint of rabbits, as indicated by behavior and brain electrical activity. *Lab. Anim. Care* **15**, 163–167.
- Ko, J.C.H., Thurmon, J.C., Tranquilli, W.J., Benson, G.J., and Olson, W.A. (1992). Comparison of medetomidine-propofol and medetomidine-midazolam-propofol anesthesia in rabbits. *Lab. Anim. Sci.* **42**, 503–507.
- Koch, K.L., and Dwyer, A. (1988). Effects of acetylsalicylic acid on electromechanical activity of in vivo rabbit ileum. *Dig. Dis. Sci.* **33**, 962–968.
- Komoda, Y., Nosaka, S., and Takenoshita, M. (2003). Enhancement of lidocaine-induced epidural anesthesia by deoxyacoinine in the rabbit. *J. Anesth.* **17**, 241–245.
- Korner, P.I., Uther, J.B., and White, S.W. (1968). Circulatory effects of chloralose-urethane and sodium pentobarbitone anaesthesia in the rabbit. *J. Physiol.* **199**, 253–265.
- Kourenis, G., Koutsoviti-Papadopoulos, M., Elezoglou, A., and Voutsas, A. (1992) Comparative study of the H₂-receptor antagonists cimetidine, ranitidine, famotidine, and nizatidine on the rabbit stomach fundus and sigmoid colon. *J. Pharmacobiodyn.* **15**, 561–565.
- Kozma, C., Macklin, W., Cummins, L.M., and Mauer, R. (1974). The anatomy, physiology, and the biochemistry of the rabbit. In "The Biology of the Laboratory Rabbit." (S.H. Weisbroth, R.E. Flatt, and A.L. Kraus, eds.), pp 50–90. Academic Press, Orlando, FL.
- Krogh, E. (1975). Intramuscular rabbit anesthesia: Ketamine hydrochloride and mebumalnatrimum (NFN): A safe and easy combination. *Acta Ophthalmol.* **53**, 367–368.
- Kucuk, A., Kadioglu Y., and Celebi, F. (2005). Investigation of the pharmacokinetics and determination of tramadol in rabbit plasma by a high-performance liquid chromatography-diode array detector method using liquid-liquid extraction. *J. Chromatogr. B. Analyt. Technol. Biomed. Life Sci.* **816**, 203–208.
- Kulli, J., and Koch, C. (1991). Does anesthesia cause loss of consciousness? *Trends Neurosci.* **14**, 6–10.
- Kumar, R.A., Boyer, M.I., and Bowen, C.V.A. (1993). A reliable method of anesthesia for extensive surgery in small rabbits. *Lab. Anim. Sci.* **43**, 265–266.
- Kurihara, J., Takata, Y., Suzuki, S. Okubo, Y., and Kato, H. (2000). Effect of midodrine on chlorpromazine-induced orthostatic hypotension in rabbits: Comparison with amezinium, etilefrine, and droxidopa. *Biol. Pharm. Bull.* **23**, 1445–1449.
- Langerman, L., Chaimsky, G., Golomb, E., Tverskoy, M., and Kook, A. I. (1990). Rabbit model for evaluation of spinal anesthesia: Chronic cannulation of the subarchnoid space. *Anesth. Analg.* **71**, 529–535.
- Lawson, D.M. (1985). Anesthetics and neuroendocrine function. In "CRC Handbook of Pharmacologic Methodologies for the Study of the Neuroendocrine System." (R. W. Steger and A. Johns, eds.), pp 385–406. CRC Press, Boca Raton, FL.
- Leaders, F.E., and Keasling, H.H. (1962). Oral versus subcutaneous potency of codeine, morphine, levorphan, and anileridine as measured by rabbit toothpulp changes. *J. Pharmaceut. Sci.* **51**, 46–49.
- Lebowitz, H. (1990). "Negative impedance ventilation as a novel mode of respiratory assist." MD thesis, Harvard/MIT Division of Health Sciences and Technology.
- Lee, V.H. (1983). Esterase activities in adult rabbit eyes. *J. Pharm. Sci.* **72**, 239–244.
- Lewis, G.E., Jr., and Jennings, P.B., Jr. (1972). Effective sedation of laboratory animals using Innovar-Vet-. *Lab. Anim. Sci.* **22**, 430–432.
- Lightowler, J., and Smith, A.E.W. (1963). B-(N-pyrrolidyl)-butyroanilid(ws 10): Its sub-acute toxicity, influence on morphine analgesia in the rat and morphine analgesia and respiratory depression in the rabbit. *Arch. Int. Pharmacodyn. Ther.* **144**, 97–111.
- Liles, J.H., and Flecknell, P.A. (1992). The use of non-steroidal anti-inflammatory drugs for the relief of pain in laboratory rodents and rabbits. *Lab. Anim. (Lond.)* **26**, 241–255.
- Lindquist, P.A. (1972). Induction of methoxyflurane anesthesia in the rabbit after ketamine hydrochloride and endotracheal intubation. *Lab. Anim. Sci.* **22**, 898–899.
- Linn, J.M., and Liebenberg, S.P. (1979). In vivo detection of rabbit atropinesterase. *Lab. Anim. Sci.* **29**, 335–337.
- Lipman, N.S., Phillips, P.A., and Newcomer, C.E. (1987). Reversal of ketamine/xylazine anesthesia in the rabbit with yohimbine. *Lab. Anim. Sci.* **37**, 474–477.
- Lipman, N.S., Marini, R.P., and Erdman, S.E. (1990). Comparison of ketamine/xylazine and ketamine/xylazine/acepromazine anesthesia in the rabbit. *Lab. Anim. Sci.* **40**, 395–398.
- Lipman, N.S., Weischedel, A.K., Connors, M.J., Olsen, D.A., and Taylor, N.S. (1992). Utilization of cholestyramine resin as a preventative treatment for antibiotic (clindamycin) induced enterotoxaemia in the rabbit. *Lab. Anim. (Lond.)* **26**, 1–8.
- Lockhart, S.H., Cohen, Y., Yasuda, N., Freire, B., Taheri, S., Litt, L., and Eger, E.I. II. (1991). Cerebral uptake and elimination of desflurane, isoflurane, and halothane from rabbit brain: An in vivo NMR study. *Anesthesiology* **74**, 575–580.
- Love, J.A., and Hammond, K. (1991). Group housing rabbits. *Lab. Anim. (Lond.)* **20**, 37–43.
- Ludders, J.W. (1993). Anesthesia for ophthalmic surgery. In "Textbook of Small Animal Surgery." (D. Slatter, ed.), Vol. 2, 2nd ed., pp 2276–2278. WB Saunders, Philadelphia, PA.
- Ludders, J.W., Thomas, C.B., Sharp, P., and Sedgwick, C.J. (1987). Anesthetic technique for repeated collection of blood from New Zealand white rabbits. *Lab. Anim. Sci.* **37**, 803–805.
- Lumb, W.V., and Jones, E.W. (1984). "Veterinary Anesthesia," 2nd ed. Lea & Febiger, Philadelphia, PA.
- Ma, D., Chakrabarti, M.K., and Whitwam, J.G. (1999). The combined effects of sevoflurane and remifentanyl on central respiratory activity and nociceptive cardiovascular responses in anesthetized rabbits. *Anesth. Analg.* **89**, 453–461.
- Ma, D., Sapsed-Byrne, S.M., Chakrabarti, M.K., and Whitwam, J.G. (1998). Effect of sevoflurane on spontaneous sympathetic activity and baroreflexes in rabbits. *Br. J. Anaesth.* **80**, 68–72.
- MacLeod, B. (1977). Comparison of the effects of thiopentone and halothane anaesthesia on critical oxygen tension. *Can. Anaesth. Soc.* **24**, 609–614.

- Macrae, D.J., and Guerreiro, D. (1989). Simple laryngoscopic technique for the endotracheal intubation of rabbits. *Lab. Anim. (Lond.)* **23**, 59–61.
- Madsen, J., Jensen, F., Faber, T., and Bille-Hansen, V. (1993). Chronic catheterization of the epidural space in rabbits: A model for behavioural and histopathological studies—examination of meptazinol neurotoxicity. *Acta Anaesthesiol. Scand.* **37**, 307–313.
- Maggi, C.A., Manzini, S., Parlani, M., and Meli, A. (1984). Analysis of the effects of urethane on cardiovascular responsiveness to catecholamines in terms of its interference with Ca^{++} mobilization from both intra and extracellular pools. *Experientia* **40**, 52–59.
- Malinovsky, J.M., Cozian, A., Lepage, J.Y., Mussini, J.M., Pinaud, M., and Souron, R. (1991). Ketamine and midazolam neurotoxicity in the rabbit. *Anesthesiology* **75**, 91–97.
- Malinovsky, J.M., Bernard, J.M., Baudrimont, M., Dumand, J.B., and Lepage, J.Y. (1997). A chronic model for experimental investigation of epidural anesthesia in the rabbit. *Reg. Anesth.* **22**, 80–85.
- Malinovsky, J.M., Charles, F., Baudrimont, M., Pereon, Y., Le Corre, P., Pinaud, M., and Benhamou, D. (2002). Intrathecal ropivacaine in rabbits: Pharmacodynamic and neurotoxicologic study. *Anesthesiology* **97**, 429–435.
- Marano, G., Formigari, R., Grigioni, M., and Vergari, A. (1997). Effects of isoflurane versus halothane on myocardial contractility in rabbits: Assessment with transthoracic two-dimensional echocardiography. *Lab. Anim. (Lond.)* **31**, 144–150.
- Margolis, R., and Fiegelson, P. (1963). Atropinesterase, a genetically determined rabbit serum esterase. *J. Biol. Chem.* **238**, 2620–2627.
- Marian, A.J., Wu, Y., Lim, D., McCluggage M., Youke, r K., Yu Q., Brugada., R., DeMayo, Quinones, M., and Roberts, R. (1999). A transgenic rabbit model for human hypertrophic cardiomyopathy. *J. Clin. Invest.* **104**, 1683–1692.
- Marini, R.P., Avison, D.L., Corning, B.F., and Lipman, N.S. (1992). Ketamine/xylazine/butorphanol: A new anesthetic combination for rabbits. *Lab. Anim. Sci.* **42**, 57–62.
- Marini, R.P., Hurley, R.J., Avison, D.L., and Lipman, N.S. (1993). Evaluation of three neuroleptanalgesic combinations in the rabbit. *Lab. Anim. Sci.* **43**, 338–345.
- Marini, R.P., Li, X., Harpster, N.K., and Dangler, C. (1999). Cardiovascular pathology possibly associated with ketamine/xylazine anesthesia in Dutch belted rabbits. *Lab. Anim. Sci.* **49**, 153–160.
- Marston, J.H., Rand, G., and Chang, M.C. (1965). Care, handling and anesthesia of the snowshoe hare (*Lepus americanus*). *Lab. Anim. Care* **15**, 325–328.
- Martin-Cancho, M.F., Lima, J.R., Luis, L., Crisostomo, V., Carrasco-Jimenez, M. S., and Uson-Gargallo, J. (2006). Relationship of bispectral index values, haemodynamic changes and recovery times during sevoflurane or propofol anaesthesia in rabbits. *Lab. Anim. (Lond.)* **40**, 28–42.
- Mattila, M., and Saarnivaara, L. (1968). Modification by antihistaminic drugs of the morphine analgesia in rabbits. *Ann. Med. Exp. Fenn.* **46**, 72–77.
- May, C.N., Ham, I.W., Heslop, K.E., A.S.F., and Mathias, C.J. (1988). Intravenous morphine causes hypertension, hyperglycaemia and increases sympatho-adrenal outflow in conscious rabbits. *Clin. Sci.* **75**, 71–77.
- McCallister, L.W., Lipton, J.M., Giesecke, A.H., Jr., and Clark, W.G. (1986). Rabbit ear-withdrawal test: A new analgesiometric procedure. *Pharmacol. Biochem. Behav.* **25**, 481–482.
- McCormick, M.J., and Ashworth, M.A. (1971). Acepromazine and methoxyflurane anesthesia of immature New Zealand White rabbits. *Lab. Anim. Sci.* **21**, 220–223.
- McGraph, J.C., and MacKenzie, J.E. (1977). Effects of intravenous anaesthetics on the cardiovascular system of the rabbit. *Br. J. Pharmacol.* **61**, 199–212.
- McGrath, J.C., MacKenzie, J.E., and Millar, R.A. (1975). Circulatory responses to ketamine: Dependence on respiratory pattern and background anaesthesia in the rabbit. *Br. J. Anaesth.* **47**, 1149–1156.
- Mehler, S.J. (2006). Common surgical procedures. In “BSAVA Manual of Rabbit Medicine and Surgery.” (A. Meridith and P. A. Flecknell, eds.), pp 166–168. British Small Animal Veterinary Association, Gloucester, UK.
- Melich, D. (1990). Method for chronic intravenous infusion of the rabbit via the marginal ear vein. *Lab. Anim. Sci.* **40**, 327–328.
- Melzack R.,Coderre, T.J., Katz, J., and Vaccarino, A.L. (2001). Central neuroplasticity and pathological pain. *Ann. N.Y. Acad. Sci.* **933**, 157–174.
- Mero, M., Makela, A., Vainionpaa, S., Vihtonen, K., and Rokkanen, P. (1987). Use of neuroleptanaesthesia for experimental orthopaedic surgery in the rabbit. *Acta Vet. Scand.* **28**, 251–252.
- Mero, M., Vainionpss, S., Vasenius, J., Vihtonen, K., and Rokkanen, P. (1989). Medetomidine-ketamine-diazepam anesthesia in the rabbit. *Acta Vet. Scand. Suppl.* **85**, 135–137.
- Messonnier, S. (1996). Formulary for exotic pets. *Vet. Forum* **13**, 46–49.
- Mills, P., Sessler, D.I., Moseley, M., Chew, W., Pereira, B., James, T.L., and Litt, L. (1987). In vivo 19F nuclear magnetic resonance study of isoflurane elimination from the rabbit brain. *Anesthesiology* **67**, 169–173.
- Mook, P.H., Proctor, H.J., Zee, H.V.D., Ennema, J.J., and Wildevuur, C.R.H. (1984). High-frequency ventilation in rabbits with respiratory insufficiency. *J. Surg. Res.* **36**, 614–619.
- Moore, L.R.C., Chang, S.-F., and Greenstein, E.T. (1987). Urethane-acepromazine: A novel method of administering parenteral anesthesia in the rabbit. *Methods Find. Exp. Clin. Pharmacol.* **9**, 711–715.
- More, R.C., Kody, M.H., Kabo, J.M., Dorey, F.J., and Meals, R.A. (1989). The effects of two non-steroidal antiinflammatory drugs on limb swelling, joint stiffness, and bone torsional strength following fracture in a rabbit model. *Clin. Orthop.* **247**, 306–312.
- Morita, H., Nishida, Y., Uemura, N., and Hosomi, H. (1987). Effect of pentobarbital anesthesia on renal sympathetic nerve activity in the rabbit. *J. Auton. Nerv. Syst.* **20**, 57–64.
- Murai, S., and Ogura, Y. (1978). Effects of several analgesics on the number of vocalization discharges in the rabbit. *Jpn. J. Pharmacol.* **28**, 636–639.
- Murdock, H.R., Jr. (1969). Anesthesia in the rabbit. *Fed. Proc.* **28**, 1510–1516.
- Mustola, S.T., Rorarius, M.G., Baer, G.A., Rosenberg, P., Seppala, T., and Harmoinen, A. (2000). Potency of propofol, thiopentone and ketamine at various endpoints in New Zealand White rabbits. *Lab. Anim. (Lond.)* **34**, 36–45.
- Nelson, J.M., Krummel, T.M., Haynes, J.H., Flood, L.C., Sauer, L., Flake, A. W., and Harrison, M.R. (1990). Operative techniques in the fetal rabbit. *J. Invest. Surg.* **3**, 393–398.
- Nevalainen, T., Pyhala, L., Voipio, H., and Virtanen, R. (1989). Evaluation of anaesthetic potency of medetomidine-ketamine combination in rats, guinea-pigs and rabbits. *Acta Vet. Scand.* **85**, 139–143.
- NIH. (1991). Preparation and maintenance of higher mammals during neuroscience experiments. Publication # 91-3207. National Institutes of Health.
- Nordin, U., Lindhalm, C.E., and Wolgast, M. (1977). Bloodflow in the rabbit tracheal mucosa under normal conditions and under the influence of tracheal intubation. *Acta Anaesthesiol. Scand.* **21**, 81–94.
- Olson, M.E., McCabe, K., and Walker, R.L. (1987). Guaifenesin alone or in combination with ketamine or sodium pentobarbital as an anesthetic in rabbits. *Can. J. Vet. Res.* **51**, 383–386.
- Olson, M.E., Vizzutti, D., Morck, D.W., and Cox, A.K. (1994). The parasympatholytic effects of atropine sulfate and glycopyrrolate in rats and rabbits. *Can. J. Vet. Res.* **57**, 254–258.
- Orr, H.E., Roughan, J.V., and Flecknell, P.A. (2005). Assessment of ketamine and medetomidine anaesthesia in the domestic rabbit. *Vet. Anaesth. Analg.* **32**, 271–279.
- Orszulak-Michalak, D. (1996). Influence of lidocaine on the hemodynamic parameters in rabbits during general anesthesia. *Pol. J. Pharmacol.* **48**, 153–162.
- Pandeya, N.K., and Lemon, H.M. (1965). Paraldehyde: An anesthesia for recovery experiments in albino rabbits. *Lab. Anim. Care* **15**, 304–306.
- Parga, M. (2003). Assessment of the efficacy of meloxicam and development of a pain-scoring system based on behaviour in rabbits undergoing elective surgery. BSAVA Congress 2003 Scientific Proceedings, Veterinary Programme, p 555. BSAVA Publications, Gloucester.
- Patel, P.M., and Mutch, W.A.C. (1990). Cerebral pressure-flow relationship during 1.0 MAC isoflurane anesthesia in the rabbit: The effect of different vasopressors. *Anesthesiology* **72**, 118–124.

- Paul-Murphy, J., and Ramer, J.C. (1998). Urgent care of the pet rabbit. *Vet. Clin. North Am. Exot. Anim. Pract.* **1**, 127–152.
- Paulsen, R., and Valentine, J.L. (1984). Procedure for intravenous administration of drugs and repeated arterial blood sampling in the rabbit. *Lab. Anim.* (Nov./Dec.), 34–36.
- Peeters, M.E., Gil, D., Teske, E., Eyzenbach, V., v d Brom, W.E., Lumeij, J.T., and de Vries, H.W. (1988). Four methods for general anaesthesia in the rabbit: A comparative study. *Lab. Anim. (Lond.)* **22**, 355–360.
- Perrin, A., Milano, G., Thyss, A., Cambon, P., and Schneider, M. (1990). Biochemical and pharmacological consequences of the interaction between methotrexate and ketoprofen in the rabbit. *Br. J. Cancer* **62**, 736–741.
- Perry-Clark, L.M., and Meunier, L.D. (1991). Vascular access ports for chronic serial infusion and blood sampling in New Zealand white rabbits. *Lab. Anim. Sci.* **41**, 495–497.
- Phaneuf, L.R., Barker, S., Groleau, M.A., and Turner, P.V. (2006). Tracheal injury after endotracheal intubation and anesthesia in rabbits. *J. Am. Assoc. Lab. Anim. Sci.* **45**, 67–72.
- Piercey, M.F., and Schroeder, L.A. (1980). A quantitative analgesic assay in the rabbit based on the response to tooth pulp stimulation. *Arch. Int. Pharmacodyn. Ther.* **248**, 294–304.
- Pleuvry, B.J., and Rees, J.M.H. (1969). The effects of etorphine and of morphine on respiration, blood carbon dioxide tension, and carbon dioxide sensitivity in the conscious rabbit. *J. Pharmacol. Pharmacodyn.* **21**, 814–825.
- Popilskis, S.J., Oz, M.C., Gorman, P., Florestal, A., and Kohn, D.F. (1991). Comparison of xylazine with tiletamine-zolazepam (Telazol®) and xylazine-ketamine anesthesia in rabbits. *Lab. Anim. Sci.* **41**, 51–53.
- Princi, T., Delbello, G., and Grill, V. (2000). Experimental urethane anaesthesia prevents digoxin intoxication: Electrocardiographic and histological study in rabbit. *Pharmacol. Res.* **42**, 355–359.
- Radzialowski, F.M., and Bousquet, W.F. (1968). Daily rhythmic variation in hepatic drug metabolism in the rat and mouse. *J. Pharmacol. Exp. Ther.* **163**, 229–238.
- Raimondi, G., Legramante, J.M., Iellamo, F., Cassarino, S., and Peruzzi, G. (1996). Cardiorespiratory response patterns to afferent stimulation of muscle nerves in the rabbit. *J. Appl. Physiol.* **81**, 266–273.
- Raman, J., Montano, S.R., and Lord, R.S.A. (1989). Assisted local anaesthesia in rabbits. *Microsurgery* **10**, 75–76.
- Rapson, W.S., and Jones, T.C. (1964). Restraint of rabbits by hypnosis. *Lab. Anim. Care* **14**, 131–133.
- Reed, R.P., Marcello, J., Welzel, G., and Schechter, A. (1987). Gavaging a rabbit with a rubber catheter. *Lab. Anim.* **16**(6), 51–52.
- Reed, T.E. (1990). Did you know? Probiotics. *Domest. Rabbits* 28–29.
- Rich, G.F., Sullivan, M.P., and Adams, J.M. (1990). Is distal sampling of end-tidal CO₂ necessary in small subjects? *Anesthesiology* **73**, 265–268.
- Robertson, S.A., and Eberhart, S. (1994). Efficacy of the intranasal route for administration of anesthetic agents to adult rabbits. *Lab. Anim. Sci.* **44**, 159–165.
- Robson, W.L., Bayliss, C.E., Feldman, R., Goldstein, M.B., Chen, C.-B., Richardson, R.M.A., Stinebaugh, B.J., Tam, S.-C., and Halperin, M.L. (1981). Evaluation of the effect of pentobarbital anaesthesia on the plasma potassium concentration in the rabbit and the dog. *Can. Anaesth. Soc. J.* **28**, 210–216.
- Ruta, T.S., and Mutch, W.A.C. (1989). Regional cerebral blood flow following hemorrhage during isoflurane anesthesia in the rabbit: Comparison of techniques to support blood pressure. *Anesthesiology* **70**, 978–983.
- Sainz, M., Martinez, F., Ciges, M., de Carlos, R., and de la Cruz, T. (1987). Brainstem and middle latency auditory evoked responses in rabbits with halothane anaesthesia. *Acta Otolaryngol.* **S103**, 613–619.
- Saito, T., Tanuma, K., Tanuma, Y., Futami, C., Shichinohe, K., Shimizu, M., Sasako, M., Shafland, J., Wang, B.C., Carlsson, C., and Carney, E. (2002). Appendectomy in rabbits with extended unilateral anesthesia. *Exp. Anim.* **51**, 63–68.
- Salonen, J.S. (1992). Chemistry and pharmacokinetics of the α₂-adrenoreceptor agonists. In "Animal Pain." (C.E. Short and A. van Poznak, eds.), pp 191–200. Churchill Livingstone, New York.
- Sakamoto, T., Kawaguchi, M., Kakimoto, M., Inoue, S., Takahashi, M., and Furuya, H. (2003). The effect of hypothermia on myogenic motor-evoked potentials to electrical stimulation with a single pulse and a train of pulses under propofol/ketamine/fentanyl anesthesia in rabbits. *Anesth. Analg.* **96**, 1692–1697.
- Sanford, T.D., and Colby, E.D. (1980). Effect of xylazine and ketamine on blood pressure, heart rate and respiratory rate in rabbits. *Lab. Anim. Sci.* **30**, 519–523.
- Sartick, M., Eldridge, M.L., Johnson, J.A., Kurz, K.D., Fowler, W.L., Jr., and Payne, C.G. (1979). Recovery rate of the cardiovascular system in rabbits following short-term halothane anesthesia. *Lab. Anim. Sci.* **29**, 186–190.
- Scheller, M.S., Saidman, I.J., and Partridge, B.L. (1988). MAC of sevoflurane in humans and the New Zealand white rabbit. *Can. J. Anaesth.* **35**, 153–156.
- Scheving, L.E., Vedral, D.F., and Pauly, J.E. (1968). A circadian susceptibility rhythm in rats to pentobarbital sodium. *Anat. Rec.* **160**, 741–749.
- Schutten, W.H., and Van Horn, D.L. (1977). Effects of ketamine sedation and ketamine-pentobarbital anesthesia upon the intraocular pressure of the rabbit. *Invest. Ophthalmol. Vis. Sci.* **16**, 531–534.
- Schuyt, H.C., and Leene, W. (1977). Improved method of tracheal intubation in the rabbit. *Lab. Anim. Sci.* **27**, 690–693.
- Schuyt, H.C., Meeder, P., and Leene, W. (1978). Bit to immobilize the endotracheal tube in the intubated rabbit. *Lab. Anim. Sci.* **28**, 470–471.
- Sebel, P.S., and Lowdon, J.D. (1989). Propofol: A new intravenous anesthetic. *Anesthesiology* **71**, 250–277.
- Sedgwick, C.J. (1986). Anesthesia for rabbits. *Vet. Clin. North Am. Food Anim. Pract.* **2**, 731–736.
- Sherrard, E. (1966). Anesthesia of rabbits [letter]. *Vet. Rec.* **253**, 254.
- Smith, J.C., Robertson, L.D., Auhill, A., March, T.J., Derring, C., and Bolon, B. (2004) Endotracheal tube versus laryngeal mask airways in rabbit inhalation anesthesia: Ease of use and waste gas emissions. *Contemp. Top. Lab. Anim. Sci.* **43**, 22–25.
- Smith, P.A., Prieskorn, D.M., Knutsen, C.A., and Ensminger, W.D. (1988). Method for frequent blood sampling in rabbits. *Lab. Anim. Sci.* **38**, 623–625.
- Squire, R., Siddiqui, S.Q., DiNunzio, G., and Brodsky, L. (1990). Quantitative study of the tracheotomy and endotracheal intubation on the rabbit tracheobronchial tree. *Ann. Otol. Rhinol. Laryngol.* **99**, 62–68.
- Stadnicka, A., Flynn, N.M., Bosnjak, Z.J., and Kampine, J.P. (1993). Enflurane, halothane, and isoflurane attenuate contractile responses to exogenous and endogenous norepinephrine in isolated small mesenteric veins of the rabbit. *Anesthesiology* **78**, 326–334.
- Stampfij H.F., and Quon, C.Y. (1995). Polymorphic metabolism of fleistolol and other ester containing compounds by a carboxylesterase in New Zealand white rabbit blood and cornea. *Res. Commun. Mol. Pathol. Pharmacol.* **88**, 87–97.
- Stanski, D.R. (1990). Monitoring depth of anesthesia. In "Anesthesia." (R.D. Miller, ed.), 3rd ed., pp 1001–1029. Churchill Livingstone, New York.
- Stickrod, G., Ebaugh, T., and Garnett, C. (1981). Use of a mini-peristaltic pump for collection of blood from rabbits. *Lab. Anim. Sci.* **31**, 87–88.
- Strack, L.E., and Kaplan, H.M. (1968). Fentanyl and droperidol for surgical anesthesia of rabbits. *J. Am. Vet. Med. Assoc.* **153**, 822–825.
- Stunkard, J.A., and Miller, J.C. (1974). Outline guide to general anesthesia in exotic species. *Vet. Med. Small Anim. Clin.* **1181**–1186.
- Swindle, M.W., Nolan, T., Jacobson, A. Wolf, P., Dalton, M.J., and Smith, A.C. (2005). Vascular access port (VAP) usage in large animal species. *Contemp. Top. Lab. Anim. Sci.* **44**, 7–17.
- Taber, R.I. (1974). Predictive value of analgesic assays in mice and rats. *Adv. Biochem. Psychopharmacol.* **21**, 191–211.
- Taplu, A., Gokmen, N., Erbayraktar, S., Sade, B., Erkan, N., Karadibak, K., and Arkan, A. (2003). Effects of pressure- and volume-controlled inverse ratio ventilation on haemodynamic variables, intracranial pressure and cerebral

- perfusion pressure in rabbits: A model of subarachnoid haemorrhage under isoflurane anaesthesia. *Eur. J. Anaesthesiol.* **20**, 690–696.
- Takata, Y., Kurihara, J., Suzuki, S., Okubo, Y., and Kato, H. (1999). A rabbit model for evaluation of chlorpromazine-induced orthostatic hypotension. *Biol. Pharm. Bull.* **22**, 457–462.
- Tashiro, C., Muranishi, R., Gomyo, I., Mashimo, T., Tomi, K., and Yoshiya, I. (1986). Electroretinogram as a possible monitor of anesthetic depth. *Arch. Clin. Exp. Ophthalmol.* **224**, 473–476.
- Thomasson, B., and Ravitch, M. (1969). Fetal surgery in the rabbit. *Surgery* **66**, 1092–1102.
- Tillman, P., and Norman, C. (1983). Droperidol-fentanyl as an aid to blood collection in rabbits. *Lab. Anim. Sci.* **33**, 181–182.
- Todd, M.M., Wu, B., Warner, D.S., and Maktabi, M. (1994). The dose-related effects of nitric oxide synthase inhibition on cerebral blood flow during isoflurane and pentobarbital anesthesia. *Anesthesiology* **80**, 1128–1136.
- Tran, H.S., Puc, M.M., Tran, J-L., V., Del Rossi, A.J., and Hewitt, C.W. (2001). A method of endoscopic endotracheal intubation in rabbits. *Lab. Anim. (Lond.)* **35**, 249–252.
- Tucker, F.S., and Beattie, R.J. (1983). Qualitative microtest for atropine esterase. *Lab. Anim. Sci.* **33**, 268–269.
- Turner, P.V., Chen, H.C., and Taylor, M.W. (2006). Pharmacokinetics of meloxicam in rabbits after single and repeat oral dosing. *Comp. Med.*, **56**, 63–67.
- Ugur, B., Basaloglu, K., Yurtseven, T., Ates, U., Aydin, O.N., Ozenc, D., Yurtseven, M., and Gurel, A. (2005). Neurotoxicity with single dose intrathecal midazolam administration. *Eur. J. Anaesthesiol.* **22**, 907–912.
- Valverde, A., Morey, T.E., Hernandez, J., and Davies, W. (2003). Validation of several types of noxious stimuli for use in determining the minimum alveolar concentration for inhalation anesthetics in dogs and rabbits. *Am. J. Vet. Res.* **64**, 957–962.
- van Zutphen, L.F.M. (1972). Qualitative and quantitative detection of atropinesterase and cocaine esterase in two breeds of rabbits. *Enzymologia* **42**, 201–218.
- Varsanno D., Rothman S., Haas, K., and Lazar M. (1996). The mydriatic effect of topical glycopyrrolate. *Graefes Arch. Clin. Exp. Ophthalmol.* **234**, 205–207.
- Vachon, P., Dupras, J., Prout, R., and Blais, D. (1999). EEG recordings in anesthetized rabbits: Comparison of ketamine-midazolam and Telazol with or without xylazine. *Contemp. Top. Lab. Anim. Sci.* **38**, 57–61.
- Vranken, J.H., Troost, D., de Haan, P., Pennings, F.A., van der Vegt, M.H., Dijkgraaf, M.G., and Hollmann, M.W. (2006). Severe toxic damage to the rabbit spinal cord after intrathecal administration of preservative-free S(+)-ketamine. *Anesthesiology* **105**, 813–818.
- Walden, N.B. (1978). Effective sedation of rabbits, guinea pigs, rats and mice with a mixture of fentanyl and droperidol. *Aust. Vet. J.* **54**, 538–540.
- Ward, G.S., Johnsen, D.O., and Roberts, C.R. (1974). Use of CI 744 as an anesthetic for laboratory animals. *Lab. Anim. Sci.* **24**, 737–742.
- Warren, D.J., and Ledingham, J.G.G. (1978). Renal vascular response to haemorrhage in the rabbit after pentobarbitone, chloralose-urethane and ether anaesthesia. *Clin. Sci. Molec. Med.* **54**, 489–494.
- Weinger, M.B., and Koob, G.F. (1990). What constitutes adequate anesthesia in animals? In neonates? [letter]. *Anesthesiology* **72**, 767–768.
- Weinstein, C.H., Fujimoto, J.L., Wishner, R.E., and Newton, P.O. (2000). Anesthesia of six-week-old New Zealand white rabbits for thoracotomy. *Contemp. Top. Lab. Anim. Sci.* **39**, 19–22.
- White, G.L., and Holmes, D.D. (1976). Comparison of ketamine and the combination ketamine-xylazine for effective surgical anesthesia in the rabbit. *Lab. Anim. Sci.* **26**, 804–806.
- Wixson, S.K. (1994). Anesthesia and analgesics. In “The Biology of the Laboratory Rabbit.” (P.J. Manning, Ringler, D.H., and Newcomer, C.E., eds.), pp 87–109. Academic Press Inc., Orlando, FL.
- Worthley, S.G., Roque, M., Helft, G., Soundararajan, K., Siddiqui, M., and Reis, E.D. (2000). Rapid oral endotracheal intubation with a fibre-optic scope in rabbits: A simple and reliable technique. *Lab Anim.* **34**, 199–102.
- Wyatt, J.D., Scott, R.A.W., and Richardson, M.E. (1989). Effects of prolonged ketamine-xylazine intravenous infusion on arterial blood pH, blood gases, mean arterial blood pressure, heart and respiratory rates, rectal temperature and reflexes in the rabbit. *Lab. Anim. Sci.* **39**, 411–416.
- Wyler, F. (1974). Effect of general anesthesia on distribution of cardiac output and organ blood flow in the rabbit: Halothane and chloralose-urethane. *J. Surg. Res.* **17**, 381–386.
- Wyler, F., and Weisser, K. (1972). Effect of halothane anaesthesia on distribution of cardiac output and organ blood flow in the rabbit. *Br. J. Anaesth.* **44**, 551–555.
- Wynn, R.L., El’Baghdady, Y.M., Ford, R.D., Thut, P.D., and Rudo, F.G. (1984). Rabbit tooth-pulp assay to determine ED₅₀ values and duration of action of analgesics. *J. Pharmacol. Methods* **11**, 109–117.
- Xu, H., Aibiki, M., Seki, K., Ogura, S., and Ogli, K. (1998). Effects of dexmedetomidine, an alpha2-adrenoceptor agonist, on renal sympathetic nerve activity, blood pressure, heart rate and central venous pressure in urethane-anesthetized rabbits. *J. Auton. Nerv. Syst.* **71**, 48–54.
- Ypsilantis, P., Didilis, V.N., Politou, M., Bougioukas, I., Bougioukas, G., and Simopoulos, C. (2005). A comparative study of invasive and oscillometric methods of arterial blood pressure measurement in the anesthetized rabbit. *Res. Vet. Sci.* **78**, 269–275.
- Zhou, Z., Du, M., Wu, W., Jiang, Y., and Han, J. (1981). Effects of intracerebral microinjection of naloxone on acupuncture- and morphine-analgesia in the rabbit. *Sci. Sinica* **24**, 1166–1178.

This page intentionally left blank

Chapter 12

Anesthesia and Analgesia in Nonhuman Primates

Sulli J. Popilskis, Donald R. Lee, and David B. Elmore

I. Introduction	336
II. Preanesthetic Considerations	336
A. Preoperative Planning	336
III. Anesthetic Delivery and Techniques	337
A. General	337
B. Chemical Restraint	339
IV. Anticholinergic Drugs	340
V. Parenteral Anesthetics	340
A. Dissociative Anesthetic Combinations	340
B. Alphaxolone–Alphadolone (Saffan®)	345
C. Propofol	345
D. Barbiturates	346
E. Opioids	346
F. Etomidate	347
G. Muscle Relaxants	347
VI. Inhalational Anesthesia	348
A. Induction	348
B. Intubation	348
C. Nitrous Oxide	349
D. Halothane	349
E. Isoflurane	350
F. Sevoflurane	350
VII. Intraoperative Monitoring	351
A. Cardiovascular Monitoring	351
B. Respiratory Monitoring	351
C. Depth of Anesthesia	352
D. Body Temperature	352
E. Urinary Output	352
VIII. Intraoperative Support	352
IX. Special Anesthetic Considerations	353
A. Obstetric Anesthesia	353
B. Pediatric Anesthesia	354
C. Anesthesia for Laparoscopic and Thorascopic Procedures	355
D. Anesthesia for Magnetic Resonance Imaging	355

E. Anesthesia for Neurological Procedures	356
X. Postoperative Care	357
XI. Analgesia	358
References	360
Personal Communications	363

I. INTRODUCTION

Nonhuman primates are important models for a wide variety of biomedical and behavioral research because of their close phylogenetic relationship to humans. They are useful models for experimental surgical studies such as organ transplantation, neuroscience, and cardiovascular disease. Better defining the research use and understanding the clinical management of nonhuman primates have helped to assure the most effective use of available animals. Advances in methods of anesthesia and analgesia have played an important role in ensuring the humane treatment of nonhuman primates. Of the approximate 190 species of prosimians, New World and Old World monkeys, and apes, the majority of nonhuman primates used in biomedical research are the macaques (*Macaca* spp.), baboon (*Papio* spp.), patas monkey (*Erythrocebus patas*), African Green monkey (*Chlorocebus* sp.), squirrel monkey (*Saimiri* spp.), marmosets (*Callitrichidae*), and chimpanzee (*Pan troglodytes*) (Table 12-1).

When selecting methods for anesthesia and restraint, the diversity of the order Primata must be considered. The wide range in body size and weight of nonhuman primates plays an important role in selecting an appropriate anesthetic, the route of administration, and dosage of the drug (Sainsbury et al., 1989). Extrapolation of anesthetic or analgesic doses from one primate species to another should be done with caution, because of differences in the responses of some species to certain agents. For

example, the anesthetic dose of alphaxolone–alphadolone for macaques can exceed the lethal dose for the adult *Saimiri sciureus* (Logdberg, 1988). Other criteria within the same species, such as age and gender of the animal, should be considered when determining appropriate anesthesia or analgesia management. The decreased ability of the neonate to metabolize drugs and the immaturity of the blood–brain barrier are examples that could reduce the safe and effective dose of some anesthetics. The purpose of this chapter is to provide the reader with a review of the literature on techniques, methodologies, and agents that have been reported in commonly used nonhuman primates, along with those that have been found to be effective by the authors. In some instances in which there is little information available in the literature and for which the authors have had insufficient experience, information has been obtained from knowledgeable clinicians by personal communication (Benson, 2000). The overall goal of this chapter is to provide veterinarians and investigators with information that will help ensure that nonhuman primates are provided with optimal anesthesia and analgesia during their use as research subjects.

II. PREANESTHETIC CONSIDERATIONS

A. Preoperative Planning

1. Health and Safety

Since some nonhuman primates carry potentially hazardous zoonotic viruses, any discussion relative to the handling nonhuman primates, the topics of personnel health and safety, as well as biosecurity of the animals should be considered in advance. A plan that addresses safety concerns relative to infectious, non-infectious, and physical hazards associated with working with research nonhuman primates should be in place. This plan may require special training of personnel, or demand unique management, engineering, or equipment needs to mitigate the risk of contamination or injury, to both personnel and the research subject.

Numerous pathogenic organisms can be transmitted from nonhuman primates to humans, and several human pathogens are communicable to nonhuman primates. Since nonhuman primates and humans have a relatively close phylogenetic relationship, the risk of transmission is greater than with other laboratory animals [National Research Council (NRC), 2003]. Naturally occurring zoonotic diseases, as well as experimentally induced infectious disease in the nonhuman primate model,

TABLE 12-1

NOMENCLATURE OF NONHUMAN PRIMATES COMMONLY USED IN BIOMEDICAL RESEARCH

Scientific name	Common name
<i>Callithrix jacchus jacchus</i>	Common marmoset
<i>Cebus</i> spp.	Capuchin monkeys
<i>Chlorocebus aethiops</i>	African green monkeys
<i>Erythrocebus patas</i>	Patas monkey
<i>Macaca arctoides</i>	Stump-tailed macaque
<i>Macaca fascicularis</i>	Cynomolgus macaque
<i>Macaca fuscata</i>	Japanese macaque
<i>Macaca mulatta</i>	Rhesus macaque
<i>Macaca nemestrina</i>	Pig-tailed macaque
<i>Pan troglodytes</i>	Chimpanzee
<i>Papio anubis</i>	Olive baboon
<i>Papio cynocephalus</i>	Yellow baboon
<i>Papio hamadryas</i>	Sacred baboon
<i>Saguinus</i> spp.	Tamarins
<i>Saimiri</i> spp.	Squirrel monkeys

must be considered. All personnel involved in providing anesthesia, analgesia, and perioperative care of nonhuman primates should be fully aware of means to prevent possible exposure to zoonotic diseases, and any other induced infectious or communicable hazard (Wallis and Lee, 1999).

Personnel should receive training in use of personal protective clothing, compliance with universal precautions relative to sharps, and should be enrolled in an appropriate occupational health program [Adams et al., 1995; National Research Council (NRC), 1996]. Personnel "at risk" should also be aware of hazards associated with nonhuman primate behavior that could lead to bites, scratches, and splashes of potentially harmful body fluids. Occupational health and safety must also identify other noninfectious hazards to personnel such as volatile anesthetics, and potentially harmful chemical exposures (oral/ocular exposure to disinfectants, ketamine, etc.).

In consideration of biosecurity, each anesthetized nonhuman primates should be protected from cross-transmission of infectious organisms from other nonhuman primates. This may require species or cohort separation, dedicated equipment or space, and other management factors to prevent transmission of pathogens that may not even be readily apparent, such as Herpes B virus, *Mycobacterium tuberculosis*, simian immunodeficiency virus (SIV), simian hemorrhagic fever (SHF), etc.

2. History and Records and Patient Evaluation

Preoperative assessment includes history of previous use, physical examination, pertinent laboratory data, and the influence of the current experimental protocol on anesthesia management. The animal's clinical and experimental history should be reviewed with respect to current or recent treatments or procedures; as well as experience to previously applied anesthetic regimens.

Despite the limitations associated with performing a thorough physical examination in the awake nonhuman primate, important signs of illness that can be readily identified are unusual posture or behavior, anorexia, and abnormal urine or feces. Obtaining body weight and temperature, auscultation for heart rhythm and bilateral lung sounds, palpation of femoral triangle for any large A/V fistulas, and observation of the animal's color and perfusion during the preoperative period will provide additional information on the physical status of the animal. Routine laboratory tests (e.g., CBC, blood chemistries, and select serology) may be performed while nonhuman primates are in quarantine, prior to study enrollment, or at predefined regular intervals (Southerns and Ford, 1995). Variations in testing within an institution may reflect specific needs associated with the use of nonhuman primates. It is usually not necessary to perform additional clinical laboratory testing in animals that are in good physical condition. However, in anticipating the impact of an experimental protocol on the animal's health, additional laboratory data may be prudent. For example, a baseline evaluation of the patient's hematocrit, hemoglobin level, and possibly blood

type and cross-match may be desirable for nonhuman primates undergoing extracorporeal bypass or other surgical procedures (SP), which may produce vascular volume deficiencies.

Concomitant natural and experimental disease may influence the selection of an appropriate anesthetic protocol. Particular anesthetics or analgesics may be contraindicated, or require modified use in nonhuman primates with abnormal cardiovascular dynamics, liver, or renal function, as such conditions may affect anesthetic distribution, metabolism, or excretion (Hom et al., 1999).

To meet a greater demand for tissue oxygenation, anemic nonhuman primates may compensate with physiologic changes such as an increase in heart rate and cardiac output. Anesthetics that reduce a previously elevated cardiac output could interfere with tissue oxygen delivery. Anemia may also reduce the solubility of volatile anesthetics and, consequently, accelerate the rate at which the alveolar concentration can be increased or decreased.

3. Fasting

Preoperative fasting is an accepted practice for nonhuman primates undergoing SP. Although the optimal fasting time in nonhuman primates has not been established, it is conventional practice to fast primates for at least 12 hours in order to decrease the risk of pulmonary aspiration. Exceptions to this are the *Callitrichidae* (marmosets and tamarins) and other small species who generally are fasted only 6–8 hours to help avoid perioperative hypoglycemia. Human (Schreiner et al., 1990) and nonhuman primate (Popilskis et al., 1992) studies suggest that prolonged withholding of clear fluids neither reduces gastric volume nor increases pH, and does not decrease the risk of aspiration of gastric contents when compared to 3 hours of withholding fluids. It is probable that withholding water for only 3 hours may reduce the likelihood of hypotension especially in young primates; however, clearly this recommendation cannot be applied to solid foods.

Inclusion of a histamine (H₂) receptor antagonist reduces the risk of aspiration pneumonia by blocking histamine-induced secretion of gastric fluid. The addition of antagonists such as cimetidine (10 mg/kg) or ranitidine (1.5 mg/kg) 30–40 minutes before induction provides adequate protection against aspiration pneumonia in *Papio* spp. (Popilskis et al., 1992). Unlike cimetidine, ranitidine does not affect cytochrome P450 (Somogyi and Gugler, 1982) and, therefore, might be a useful adjunct in situations requiring emergency surgery or in pregnant animals in which gastric emptying is delayed.

III. ANESTHETIC DELIVERY AND TECHNIQUES

A. General

Research nonhuman primates encompass a wide range of size, from New World species represented by adults that may

be quite small and weigh only a few hundred grams to adult chimpanzees that are much larger, most weighing over 50 kg. Inherent in this species diversity is a wide range of physiological capabilities that are important to the consideration of an anesthetic regime, such as tidal volume, relative blood volume, subcutaneous and intramuscular (IM) volume, ability to maintain body heat, and the animal's energy reserves. Within a given species there may also be factors that influence anesthesia, based on the age of the animal, that is, juvenile versus adult.

Research nonhuman primates possess unique behavioral characteristics and are relatively quick and strong for their size. This also is critical in consideration of how an anesthetic agent will be safely delivered. Delivery of anesthesia in nonhuman primates generally begins with some effective means of restraint or cooperative training (Klein and Murray, 1995). This may include one or a combination of methods, such as operant training [presenting a limb for intravenous (IV) or intramuscular injection], physical restraint (squeeze back cage, manual restraint, and chair/tube restraint), or chemical restraint, or alternatively a remote injection system (dart delivery by blow pipe, hand-pump pistol, or CO₂ pistol/rifle) (Fortman et al., 2002), or oral baiting (Pulley et al., 2004). For very strong animals, and those in large enclosures, dart systems are typically required. Blow pipes and pump air guns are generally preferred over CO₂ pistols, as they are quieter, and are likely to produce less tissue damage with the impacting (Fortman et al., 2002; Fowler, 1986). These methods can cause injury to both the personnel and the animal, and should be restricted to use by experienced personnel. The more control the anesthetist has of the animal the less the stress and risk of accident or injury during the procedure. Personnel practicing any of the restraint methods listed above must possess proper experience in the implementation of the chosen technique.

IM injection into a large muscle mass, such as the caudal thigh muscles, is the most common means of administering agents for chemical restraint. Particular care should be exercised for IM injections into very small nonhuman primates, to avoid nerve damage. For repeated IM injections, it is advisable to alternate the leg to minimize the possibility of muscle or nerve irritation by drugs with low pH such as ketamine (Davy et al., 1987).

Once animals are safely controlled, repeated IM injection, or IV injection, may be employed to administer anesthetic and analgesic agents if indicated for the procedure to be performed. Inhalation anesthesia is generally provided following intubation of nonhuman primates, to prevent environmental contamination and safety concerns caused by face mask administration of volatile anesthetics.

IV access is necessary for many anesthetic protocols, in order to administer anesthetic agents, fluids, or infuse contrast material. Chemical restraint is often needed for IV injections or blood withdrawal. IV access can be intermittent, or accomplished with the placement of an indwelling catheter, or vascular access port (VAP). Depending upon the size of the animal, the frequency of access, the volume/time required to deliver the dose, and

the amount of blood to be withdrawn, the following venous sites can be used in nonhuman primates: cephalic, saphenous, femoral, and brachial veins. Indwelling catheters for use during a procedure can be easily secured in the saphenous vein in many primates, as well as in the brachial, or cephalic veins in large animals (baboons and chimpanzees). Emergency vascular access in infant macaques can also be accomplished by an intramedullary needle placed in the femur.

The femoral vein is commonly used for withdrawal of relatively large blood volumes. An indwelling catheter or needle (20 or 22 gauge) is inserted at the femoral triangle just medial to the femoral artery, which can be identified by pulsation. The femoral artery can be used for blood collection or direct intra-arterial blood pressure monitoring. Whenever the femoral artery is being used, direct pressure must be applied to prevent a hematoma, which may be of clinical importance in an animal with natural or experimental coagulopathies (Loeb et al., 1976). Blind access to the femoral artery or vein may also lead to complications due to trauma, with the formation of an arteriovenous fistula.

Chronic intravascular catheterization of nonhuman primates has been described (Barnstein et al., 1966; DaRif and Rush, 1983; Scalese et al., 1990). Placement of indwelling vascular catheters allows multiple blood sampling, administration of various therapeutic agents, and monitoring of cardiovascular parameters in a conscious, unrestrained animal, possibly reducing the frequency of the use of chemical restraint to access a vein. The use of indwelling catheters may reduce or eliminate repeated venipuncture in study animals, which can lead to trauma at the site of venous access and difficulty in obtaining a timely sample, and require access to multiple veins.

The internal and external jugular vein, femoral vein, and artery are common vascular access sites. In macaques, the iliac vein and artery are also commonly accessed, and the external jugular is typically not used, due to the difficulty in placement and the high failure rate of long-term placement and patency related to the position of the clavicle (Bernal, personal communication, 2006). Medical-grade silicon rubber tubing, often coated with anticoagulant and antibacterial materials, is commonly used for indwelling catheters. Tethering systems, consisting of a jacket, main swivel, stainless steel tether, and pump assembly, are commonly used to protect catheters from damage induced by the animal, and as a means to enable movement of the animal in its cage. Major problems associated with indwelling catheter systems are loss of catheter patency and infection. The major cause of failure of patency is the infection, which is often the result of improper aseptic technique to access the port (Bernal, personal communication, 2006). The risk of infection is related, in part, to the catheter exit site in the skin. Totally implanted subcutaneous VAP reduce the risk of infection and stress associated with multiple cutaneous venous access techniques (Schmutzler et al., 1988). VAPs are commonly used with "backpack" pumps for continuous or timed infusions and can be operated and monitored remotely.

B. Chemical Restraint

The objectives of chemical restraint are to inhibit purposeful movements by the animal that could cause injury to the personnel or escape of the primate. Personnel should be specifically cautioned of the rapidity of return of consciousness in nonhuman primates restrained with ketamine alone. Furthermore, animals that have been given sedatives, analgesics, or tranquilizers, without the use of ketamine, can be aroused from apparent depression and are very dangerous to handle.

The dissociative drugs ketamine and tiletamine have a wide margin of safety and are the most common choices for chemical restraint of research nonhuman primates. Ketamine as a sole agent for chemical restraint is commonly employed in both Old World and New World monkeys. Telazol (tiletamine + zolazepam) can also be used in nonhuman primates for simple restraint, and is a method of choice for chemical restraint in chimpanzees (Lee et al., 1991; Lee and Fleming, 1993). In nonhuman primates, these dissociative agents produce rapid induction, redistribution, and return to consciousness. They are metabolized by hepatic cytochrome P450 and excreted in the urine. Dissociative agents produce good somatic analgesia, minimal respiratory depression, and hemodynamic stability; however, used alone they produce poor muscle relaxation and can produce hypersalivation in some species. Ketamine and Telazol are controlled drugs and, as such, require specific storage and record keeping as required by the Drug Enforcement Agency (DEA). Given that the use of ketamine for chemical restraint of nonhuman primates is so frequent and wide spread, it may be useful to reiterate some advantages and possible unwanted effects of the use of this drug.

Ketamine is an analog of phencyclidine and has been widely used for chemical restraint and as an anesthetic agent in nonhuman primates since the 1970s. Ketamine produces a cataleptoid state involving unconsciousness and somatic analgesia in nonhuman primates. Ketamine has a wide margin of safety in nonhuman primates, and has been used in dosages varying from 5 mg/kg to 20 mg/kg IM in many species as an agent for restraint and induction for subsequent administration of other injectable or gaseous anesthetics. Induction is usually achieved within 5 minutes after IM administration, and a single bolus will provide chemical restraint for 15–30 minutes, which is sufficient for tuberculin testing, clinical examination, or minor procedures. Complete recovery occurs within 40–60 minutes, depending upon the dosage used. Nonhuman primates retain pharyngeal and palpebral reflexes after ketamine administration. Accordingly, laryngospasm is not uncommon during intubation after ketamine administration due to the pharyngeal reflex and irritation of the vocal cords by oropharyngeal secretions. Atropine, at a dose of 0.02–0.05 mg/kg IM, can be given to limit the salivation that usually occurs after administration of ketamine. Animals have poor muscular relaxation, and in some instances ketamine induces tonic-clonic movements and psychotomimetic emergence reactions

particularly in juveniles (Green et al., 1981). For this reason, if a procedure requires complete immobilization or if a SP is to be done, another agent is administered in combination with ketamine.

Ketamine administration may also negatively impact food intake in some old world monkeys. In a clinical trial, administration of ketamine 10 mg/kg IM to rhesus and African green monkeys was observed to significantly reduce daily feed intake, especially at 24 hours postdose (mean % intake reduction: African green monkeys 57%; rhesus males 48%, and rhesus females 40%) and at 48 hours postdose (African green monkeys 24%, rhesus males 14%, and rhesus females 13%) (Springer, and Baker presented at 2006 APV Workshop). Use of ketamine in individuals of these species may warrant consideration for alternatives, especially if the animal is debilitated or the study protocol requires frequent chemical restraint. Prolonged reduction of feed intake may negatively impact the animal's health and well-being. Alternatives may include reducing the dose of ketamine, combining with other drugs, use of other chemical agents alone, or cooperative manipulation of the animal.

The effects of ketamine on hematologic and serum biochemical values in nonhuman primates have been examined. Differences in some indices are based on whether a nonhuman primate has been given ketamine, or physically restrained with or without conditioning. Loomis et al. (1980) compared hemograms of *Macaca mulatta* that were either ketamine treated or physically restrained for venipuncture, and found that leukocyte and lymphocyte counts and total plasma protein levels were reduced in the ketamine-treated animals. Bennett et al. (1992) reported similar findings, with significant decreases in erythrocyte, lymphocyte, and total leukocyte counts; hemoglobin, hematocrit, and serum glucose; total protein, cholesterol, and albumin.

Recent studies have reported similar changes in hematologic and biochemical values in two other species of macaques. Blood samples from cynomolgus monkeys subject to ketamine anesthesia showed a reduction in leukocyte counts, lymphocyte percentages, and concentrations of glucose, sodium, and potassium, when compared to samples obtained under manual and chair restraint (Kim et al., 2005). Blood samples obtained from aged bonnet macaques that were anesthetized with ketamine also yielded lower values of total leukocyte count, lymphocyte count, and serum concentrations of glucose, sodium, and potassium, when compared to samples obtained by awake cage side restraint (Venkatesan et al., 2006). Such variations have been attributed to stress of conscious restraint.

The effect that ketamine has on the cardiovascular system and on selected plasma hormone levels in *Macaca fascicularis* has been studied (Castro et al., 1981). The animals in this study were well acclimated to restraining chairs to negate effects that could be due to animal handling rather than to ketamine. Ketamine produced no significant changes in mean arterial blood pressure, plasma insulin, glucose, or cortisol

concentrations. After insulin challenge, plasma glucose concentrations, plasma adrenocorticotrophic hormone (ACTH), growth hormone, and cortisol responses were similar in both ketamine-treated and control monkeys, which suggests that ketamine does not alter the magnitude of many endocrine responses. Brady and Koritnik (1985) reported similar findings for glucose tolerance testing in *Cercopithecus aethiops*. In general, ketamine does not produce significant respiratory depression, and induces minimal cumulative effects when given over several hours in healthy animals. Similar findings in rhesus monkeys have been reported (Hom et al., 1998), where mean arterial pressure (MAP) of ketamine-anesthetized monkeys was similar to that of unrestrained conscious monkeys recorded by radiotelemetry.

In squirrel monkeys, ketamine restraint to obtain blood samples was shown to elevate estradiol and luteinizing hormone when compared to samples obtained from animals conditioned for 3 weeks to manual restraint for blood retrieval. These results suggest a possible side effect due to the use of ketamine that could interfere with studies of cycling squirrel monkeys (Yeoman et al., 1988).

Based on the aforementioned studies, investigators should consider the potential for variability posed by how blood samples are obtained. Options for blood sample collection in nonhuman primates could include: ketamine anesthesia, unrestrained conscious sampling by radiotelemetry, physical restraint of animals trained to cooperatively present for bleeding, or physical restraint of nonhuman primates not acclimated to this procedure.

IV. ANTICHOLINERGIC DRUGS

Anticholinergics are used to diminish salivary and bronchial secretions in nonhuman primates during anesthesia and to prevent the reflex bradycardia that may be experienced during ocular or deep neck surgery (oculocardiac and vasovagal reflexes). These actions make atropine or glycopyrrolate useful adjuncts to ketamine-xylazine and ketamine-medetomidine anesthesia. Bradycardia is of great significance in young nonhuman primates because their cardiac output is heart-rate-dependent. The addition of atropine (0.02–0.05 mg/kg) will effectively reduce xylazine- and fentanyl-induced bradycardia. When an antisialogogue effect is desired, glycopyrrolate (0.005–0.01 mg/kg) is selected rather than atropine because it is twice as potent and has a longer duration of action. Nevertheless, inclusion of an anticholinergic as part of premedication is not always necessary or indicated. Noteworthy is that atropine possesses arrhythmogenic properties and may predispose nonhuman primates to ventricular tachycardia and bigeminal patterns (Sedgwick, 1986). Because of this, we usually avoid atropine premedication as part of protocols for cardiac surgery (Table 12-2).

V. PARENTERAL ANESTHETICS

A. Dissociative Anesthetic Combinations

Dissociative anesthetics are cyclohexamine derivatives, and include phencyclidine, ketamine, and tiletamine. Though phencyclidine proved to be quite useful as an agent for chemical restraint in a number of nonhuman primate species, it became a drug of abuse in humans because of its hallucinatory effects, and it is no longer manufactured for human or veterinary use. Ketamine and tiletamine are both commonly employed in combination with other agents to produce a balanced anesthesia for short procedures, or induction with volatile anesthetics. In many cases, it is beneficial to reduce the total dose of ketamine, to avoid prolonged recovery and other undesirable side effects of this agent used alone. The volume of ketamine can be reduced by combining this agent with an alpha-2 agonist (such as xylazine or medetomidine), which may provide sedation, additional analgesia, and muscle relaxation, or in combination with a benzodiazepine drugs (diazepam and midazolam) to provide sedation and muscle relaxation. Availability of specific antagonists (yohimbine, atipamezole, and flumazenil) (France and Weltman, 2006) allows reduction of anesthesia or sedation time and speeds recovery.

The following sections will discuss some of these dissociative anesthetic combinations.

1. Ketamine–Xylazine

The addition of the alpha-2 agonist xylazine to the dissociative agent ketamine provides sedation, muscle relaxation, and greater analgesia sufficient for minor SP. Ketamine (7 mg/kg) and xylazine (0.6 mg/kg) given to *M. mulatta*, varying in weight from 1 kg to 11 kg, provided adequate anesthesia for cisternal and lumbar spinal puncture, insertion of urinary catheters, tattooing, and digit amputations (Banknieder et al., 1978). The effects of various ratios of ketamine and xylazine in *M. mulatta* have been tested (Naccarato and Hunter, 1979). For their study, anesthesia was defined only as loss of response to a pinprick stimulus. Therefore, the dosages used cannot be correlated with their efficacy for surgical anesthesia, but merely as a method for chemical restraint. Among the dosage combinations used, ketamine (10 mg/kg) and xylazine (0.25 mg/kg) produced a mean anesthesia time of 45 minutes; increasing the xylazine dosage up to 2 mg/kg increased the anesthesia duration to a mean of 138 minutes.

The effects of xylazine in the Japanese monkey, *M. fuscata*, were reported to be at least partially reversed by the antagonist yohimbine HCl (0.5 mg/kg IV or 1.0 mg/kg IM) to reduce the overall time of immobilization (Hayama et al., 2006).

Reutlinger et al. (1980) have studied the effects that ketamine and xylazine have on cardiovascular and pulmonary values in *M. mulatta*. Four groups of six adult males were given ketamine (7 mg/kg), xylazine (0.6 mg/kg), ketamine and xylazine, or

TABLE 12-2

SUMMARY OF DRUGS AND DOSAGES FOR NONHUMAN PRIMATES

Drug	Macaca	Papio	Saimiri sciureus	Callithrix jacchus
Anticholinergics				
Atropine	0.02–0.05 mg/kg IM	0.02–0.05 mg/kg IM		0.04 mg/kg SQ or IM
Glycopyrrolate	0.005–0.01 mg/kg IM	0.005–0.01 mg/kg IM		
Dissociatives				
Ketamine	5.0–20 mg/kg IM; 15–30 minutes	5–10 mg/kg IM; 15–30 minutes	10–30 mg/kg IM; 15–30 minutes	15–20 mg/kg IM; 15–30 minutes
Ketamine + medetomidine	3.0 mg/kg IM, 0.15 mg/kg IM ^a			
Ketamine + diazepam		10 mg/kg IM, 0.2–0.35 mg/kg IM	15–20 mg/kg IM, 1.0 mg/kg IM	15 mg/kg IM, 1.0 mg/kg IM
Ketamine + xylazine	7 mg/kg IM, 0.6 mg/kg IM ^b		10–30 mg/kg IM, 3.0 mg/kg IM; up to 30 minutes ^a	15–22 mg/kg IM, 1.0–1.5 mg/kg IM; up to 30 minutes
Ketamine + xylazine	10 mg/kg IM, 0.25–2 mg/kg IM; 45–138 minutes ^c			
Ketamine + midazolam	15 mg/kg IM followed by 0.05–0.15 mg IV followed by ketamine infusion 12 mg/kg/h	5 mg/kg IM, 0.100 mg/kg IM		
Tiletamine + zolazepam (Telazol)	4.0–6.0 mg/kg IM; 45–60 minutes	4.0–6.0 mg/kg IM; 45–60 minutes	10 mg/kg IM	5.0 mg/kg IM; 15 minutes
Sedatives/tranquilizers				
Medetomidine	0.15 mg/kg	0.1 mg/kg IM, 5.0 mg/kg ketamine IM	0.1 mg/kg IM or SQ	
Alpha-2 antagonists				
Atipamezole	0.25 mg/kg IV, IM ^d	0.15 mg/kg IV, IM	0.2 mg IV	
Yohimbine	0.5 mg/kg IV or 1.0 mg/kg IM ^e			
Other injectable anesthetics				
Alphaxolone–alphadolone (Saffan)	120 mg/kg IM bolus, 18 mg/kg IM followed by 6–12 mg/kg IV	0.2–0.25 mg/kg/min infusion preceded by ketamine 4 mg/kg IM; up to 6 hours	11.5–15.5 mg/kg IM bolus; up to 1 hour	15–19 mg/kg IM bolus; up to 1 hour
Propofol	2.5–5.0 mg/kg IV bolus 2.5–5.0 mg/kg IV followed by infusion 0.3–0.4 mg/kg/min	2.0–4.0 mg/kg IV for induction, repeated as needed		
Barbiturates				
Pentobarbitol	20–30 mg/kg IV; 30–60 minutes, 11 mg/kg IV preceded by ketamine 20 mg/kg IM	25 mg/kg IV slowly to effect (adult), 15 mg/kg IV slowly to effect (juvenile)	15 mg/kg IV slowly to effect	

TABLE 12-2

CONTINUED

Drug	Macaca	Papio	Saimiri sciureus	Callithrix jacchus
Thiopental	5–7 mg/kg IV for induction under ketamine restraint	15–17 mg/kg/h IV infusion		
Opioids				
Fentanyl	5–10 µg/kg IV bolus or as a continuous infusion at 10–25 µg/kg/h in combination with low MAC isoflurane 0.05–0.15 µg/kg IM	5–10 µg/kg IV bolus or as a continuous infusion at 10–25 µg/kg/h in combination with low MAC isoflurane		
Muscle relaxants				
Pancuronium	0.04–0.1 mg/kg IV	0.04–0.1 mg/kg IV		
Vecuronium	0.04–0.06 mg/kg IV	0.04–0.06 mg/kg IV		
Inhalation anesthesia				
Nitrous oxide	Addition of 30% reduces MAC halothane from 1.15% to 0.75% and enflurane from 1.84% to 1.46% ^f			
Halothane	1 MAC = 0.89–1.15% ^g	0.5–1.0% supplemented with 2:1 ratio of nitrous oxide to oxygen for anesthesia maintenance		
Isoflurane	1 MAC = 1.28% ^h	1.5–2.0% on 100% oxygen; 0.8–1.25% supplemented with 2:1 ratio of nitrous oxide to oxygen for anesthesia maintenance		1.0–3.0% for maintenance
Sevoflurane	1 MAC = 2.00% ⁱ			
Analgesics				
NSAIDs				
Aspirin	325 mg PO, 125 mg/5 kg rectal suppositories	325 mg PO, 125 mg/5 kg rectal suppositories		
Carprofen	2–4 mg/kg, SC, IV ^j			
Ibuprofen	7 mg/kg, PO		7 mg/kg, PO	
Ketorolac tromethamine	0.5–1.0 mg/kg	15–30 mg IM		
Meloxicam	0.2–0.2 mg/kg, PO ^k			
Opioids				
Morphine	1–2 mg/kg IM, SQ; 4 hours	1–2 mg/kg IM, SQ; 4 hours 0.15 mg/kg epidurally; up to 24	1–2 mg/kg IM, SQ; 4 hours	
Oxymorphone	0.15 mg/kg IM; 4–6 hours	0.15 mg/kg IM; 4–6 hours	0.075 mg/kg IM; 4–6 hours	0.075 mg/kg IM; 4–6 hours
Meperidine	2 mg/kg IM; 4 hours	2–4 mg/kg IM		
Buprenorphine	0.01 mg/kg IM; 6–8 hours	0.01–0.03 mg/kg IM BID	0.015 mg/kg IM; 6–8 hours	0.02 mg/kg SQ; 6 hours
Butorphanol	0.05 mg/kg IM TID		0.02 mg/kg SC QID	
Opioid antagonist				
Naloxone	0.1–0.2 mg as needed	0.1–0.2 mg as needed	0.1–0.2 mg as needed	0.1–0.2 mg as needed

Note: *Macaca* (Flecknell, 2005; Hayama et al., 2006; Horne, 2001; Naccarato and Hunter, 1979; Reutlinger et al., 1980; Soma et al., 1995; Steffey et al., 1974a; Sun Alan, 2000); and *Pan troglodytes* (Lee et al., 2005).

saline. There were no significant differences among the three drug regimens and saline control animals with regard to mean respiratory rate, acid–base status, or arterial blood gases. However, xylazine or xylazine combined with ketamine produced statistically significant decreases in mean arterial blood pressure and heart rate compared to animals given ketamine. Xylazine-induced bradycardia and hypotension are common in most species and are associated with decreased outflow of sympathetic nervous system impulses to the periphery. The significant decrease in blood pressure and heart rate encountered in xylazine and xylazine–ketamine groups indicates that xylazine overrides the stimulatory effects of ketamine.

Ketamine (15–20 mg/kg) and xylazine (1 mg/kg) given IM to juvenile *P. troglodytes* provided anesthesia with sufficient analgesia for performing minor procedures such as plasmapheresis and percutaneous liver biopsies. Laryngeal and pharyngeal reflexes remained intact, and endotracheal intubation was not possible. The average time of anesthesia was 25 minutes with recovery in about 2 hours (April et al., 1982).

2. Ketamine–Medetomidine

Ketamine–medetomidine is a combination of dissociative agent with an alpha-2 agonist. It has been successfully used in a number of nonhuman primates including Old World species, New World monkeys, and Apes.

Medetomidine-induced sedation, analgesia, and muscle relaxation can be reversed with atipamezole, a specific alpha-2 antagonist. Animals given atipamezole at five times the medetomidine dose recovered within 15–20 minutes, whereas those not receiving the antagonist recovered in 1–2 hours. The advantages of this combination of agents over ketamine alone are that there was better muscle relaxation, the period of anesthesia was lengthened, and the anesthesia was partially reversed with atipamezole.

Ketamine versus a combination of ketamine–medetomidine was compared in a balanced anesthesia protocol for chemical immobilization in macaques (Sun et al., 2003). This comparison involved pigtail and rhesus macaques (*M. mulatta* and *Macaca nemestrina*). Results indicated that medetomidine (0.15 mg/kg IM) combined with ketamine (3.0 mg/kg IM) induced a deeper plane of anesthesia of longer duration than did ketamine (10 mg/kg IM) alone. Furthermore, the use of atipamezole (0.225 mg/kg IM), to reverse the effects of medetomidine, produced a more rapid recovery.

Niekrasz (personal communication, 2006) reports the use of ketamine (4 mg/kg)–medetomidine (150 µg/kg) combination in rhesus macaques. At this dose, rhesus monkeys show muscle relaxation and deep sedation, allowing a 20–30-minute window for intubation during gaseous anesthetic induction.

The combination of ketamine/medetomidine has been successfully employed in new world research monkeys. Capuchin monkeys (*Cebus apella*) were restrained with medetomidine (0.15 mg/kg IM) combined with ketamine (4 mg/kg IM) over

the course of a 15-month controlled feeding trial (Theriault and Niekrasz, personal communication, 2006). In this instance, the use of ketamine/medetomidine combination (medetomidine was reversed with atipamezole, 0.75 mg/kg IM) significantly reduced recovery time to feeding, and did not appear to have a negative impact of appetite, as did the use of ketamine alone (6–15 mg/kg IM). This combination provided rapid, reliable, reproducible, and safe sedation; and when used for anesthesia induction, permitted endotracheal intubation, restricted to a window of about 3–5 minutes.

Ferris et al. (2004) reports using ketamine/medetomidine in the common marmoset for short procedures, to lessen the effects of ketamine alone (ketamine administered at 1–3 mg/kg, followed by 0.01–0.03 mg/kg of medetomidine). The effects of medetomidine were reversed with atipamezole dosed at 0.05–0.15 mg/kg (Ferris et al., 2004).

Morris (personal communication, 1995) sedates *S. sciureus* with 100 µg/kg of medetomidine given IM or subcutaneously to facilitate mask induction with isoflurane, followed by intubation using a shortened 1.5 mm Cole neonatal endotracheal tube. Medetomidine can be reversed after anesthesia with 200 µg atipamezole to produce a very rapid recovery.

Ketamine–medetomidine has been successfully used to anesthetize *P. troglodytes* (Jalanka and Roeken, 1990; Lewis, 1993). In these reports, medetomidine (30–60 µg/kg IM) and ketamine (2–6 mg/kg IM) produced a rapid induction, prolonged and stable immobilization, excellent relaxation, and calm recovery. The duration of anesthesia was about 60 minutes, and sufficient to perform dental extraction and subcutaneous placement of implants.

3. Ketamine–Diazepam

The addition of a benzodiazepine like diazepam in combination with ketamine can provide muscle relaxation and anticonvulsant activity. Benzodiazepines are metabolized in the liver (half-life increases with depleted liver function), and some metabolites are active providing a relatively long duration.

Diazepam may be administered intramuscularly at 1.0 mg/kg or intravenously at 0.25–0.50 mg/kg. However, it is important to note that IM injection of diazepam may be painful, with unreliable absorption; multiple doses may lead to prolonged recovery due to its long elimination half-life (Jacobs et al., 1993). Flumazenil, a specific benzodiazepine receptor antagonist (0.02 mg/kg IV), was reported to result in faster recovery times in patas monkeys sedated with midazolam (Kalema-Zikusoka et al., 2003).

The addition of diazepam to ketamine eliminates excessive involuntary movements, and helps to maintain adequate immobilization. The combination of ketamine (10 mg/kg) and diazepam (0.2–0.35 mg/kg) given IM has been reported to produce an effective restraint in an adult male *Papio* during a dental study that required muscle relaxation of the mouth and head (Woolfson et al., 1980).

In *S. sciureus*, ketamine (15–20 mg/kg) and diazepam (1 mg/kg) given IM provides light to moderate anesthesia (Morris, personal communication, 1995). Wyatt (personal communication, 1995) premedicates *Callithrix jacchus* with ketamine (15 mg/kg), diazepam (1.0 mg/kg), and atropine (0.04 mg/kg) given subcutaneously. Intubation must be done within several minutes after onset of sedation due to the short duration of maximal sedation. For intubation, he uses a modified no. 8 French feeding catheter with an endotracheal tube adaptor end. To pass the tube, one hyperextends the animal's neck and places digital pressure on the outside of the larynx to aid in opening the larynx using a no. 1 Miller blade. Maintenance anesthesia is then initiated with 1–3% isoflurane at 3 L/min with oxygen.

In Elmore's experience, ketamine/diazepam combination used in macaques is insufficient to allow endotracheal intubation, and the use of propofol, ketamine plus medetomidine or thiopental may be employed for intubation.

4. Ketamine–Midazolam

Midazolam offers certain advantages over diazepam. Compared to diazepam, it is better absorbed after IM injection, provides more effective anxiolytic sedation, and has a shorter elimination half-life (Jacobs et al., 1993). These authors demonstrated that after an initial bolus of ketamine (15 mg/kg IM), an IV injection of midazolam (0.05–0.09 mg for animals less than 1 kg and 0.05–0.15 mg for animals over 1 kg), followed by a ketamine infusion (12 mg/kg/h) provided complete immobilization in young *M. mulatta* and *C. aethiops* during positron emission tomography. There were no noticeable side effects and the animals were returned to their cages within 30 minutes after discontinuation of anesthesia. In *M. mulatta*, the effective dose of midazolam decreased until 4 months of age and then gradually increased. *C. aethiops* exhibited age-dependent sensitivity to midazolam, with older animals requiring lower dosages. This may be associated with higher metabolic rates in infants and juvenile animals (Sedgwick, 1986).

IM ketamine–midazolam (ketamine 8 mg/kg and midazolam 0.2 mg/kg) anesthesia was compared to isoflurane or propofol in rhesus monkeys for a protocol evaluating intraduodenal drug administration (Authier et al., 2006). At this dose, palpebral, corneal, and pharyngeal reflexes were preserved at all times. Following intraduodenal dose of dextrose, the ketamine–midazolam group showed an inconsistent increase in glycemia when compared to the other two anesthetic regimes. Recovery from isoflurane and propofol was significantly faster than from ketamine–midazolam.

5. Tiletamine–Zolazepam (Telazol®)

Telazol is a 1:1 combination of the dissociative anesthetic, tiletamine and the benzodiazepine tranquilizer, zolazepam. It has been reported to be a useful agent for chemical restraint and an anesthetic for minor SP in nonhuman primates (Booker et al.,

1982; Cohen and Bree, 1978; Kaufman and Hahnenberger, 1975). In juvenile *M. mulatta*, the minimum dosage for restraint is 1.5 mg/kg IM, and 3.0 mg/kg for anesthesia sufficient for minor SP. At these dosages, Telazol provides a rapid onset and smooth recovery, and with the exception of depressed myocardial contractility, it has minimal cardiorespiratory effects (Booker et al., 1982). At 4–6 mg/kg IM, chemical restraint is achieved for about 45–60 minutes in *M. mulatta*, *M. nemestrina*, *Macaca arctoides*, and *Papio papio*, whereas the duration is about 100 minutes in *E. patas* (Cohen and Bree, 1978).

Similar to ketamine, the animal's physiologic responses to Telazol and blood sampling are influenced by such variables as species, time of day, and familiarity with a blood sampling process. Bentson et al. (2003) studied the effects of Telazol and blood sampling on physiological responses in male rhesus monkeys and male baboons. In macaques, reduction in cortisol was noted in the morning but not in the afternoon. In contrast, cortisol changed little in baboons. The injection of anesthetic and blood sampling process increased cortisol levels in macaques not trained to extend an arm, but had no effect in trained animals.

Lee et al. (2003) compared effects of Telazol and ketamine on various physiological parameters in cynomolgus monkeys. There were no differences in heart rate, respiratory rate, and pCO₂. However, Telazol caused a decrease in rectal temperatures that may be partially explained by prolonged immobilization caused by Telazol-treated group (67 ± 6.5 minutes) versus ketamine-treated group (42 ± 6.7 minutes). Similar decrease in body temperature was observed with Telazol administration (6 mg/kg) in cynomolgus monkeys with implanted telemetry devices (Lopez, 2002). It should be noted that Telazol dose was at the higher range that resulted in longer average duration of anesthesia (91 minutes), with some monkeys experiencing profound decrease in body temperatures exceeding 5°C. In addition, Telazol caused notable postanesthesia elevations in body temperature that lasted for more than 24 hours postinduction. The authors concluded that this postanesthesia elevation in body temperature is of importance, as it may cause misinterpretation of data from challenge with various test articles. Telazol does not significantly alter the complete blood cell count, immunologic, and serum biochemistry values in rhesus monkeys (Woodward and Weld, 1997).

Morris (personal communication, 1995) uses Telazol at a dosage of 10 mg/kg IM to produce light-to-moderate anesthesia in *S. sciureus*. Wyatt (personal communication, 1995) uses Telazol at a dosage of 5 mg/kg IM plus atropine (0.04 mg/kg IM) to provide 15 minutes of anesthesia adequate for minor invasive procedures in *C. jacchus*.

Telazol, given to *P. troglodytes* at 3–5 mg/kg IM, provides sufficient chemical restraint to perform physical examinations, sample collection, and minor procedures (Lee and Guhad, 2001). An advantage to Telazol over ketamine is that its greater potency allows for administration of smaller volumes. This is particularly helpful when a dart is used for delivery of the agent

to chimpanzees. Also, the occurrence of cyclohexylamine-induced seizures seen when using ketamine is nearly eliminated in comparison to Telazol (Lee and Fleming, 1993). There is an increase in the occurrence of ventricular premature contraction seen on electrocardiogram (ECG) readings in chimpanzees (Doane et al., 2006).

B. Alphaxolone–Alphadolone (Saffan®)

This combination steroid anesthetic, which is currently available for commercial use outside United States, has been reported as an effective anesthetic in several species of nonhuman primates. A single dose of the drug (11–19 mg/kg IM) has a short onset of action, and produces anesthetic duration of 1–1.5 hours and uneventful recovery in *C. jacchus* and *S. sciureus* (Logdberg, 1988; Phillips and Grist, 1975). An additional dosage of 3–5 mg/kg extended anesthesia for another hour in *S. sciureus* (Logdberg, 1988). It has been used successfully as a sole anesthetic for various abdominal procedures, bone tissue excision, and magnetic resonance imaging (MRI) procedures (Logdberg, 1988). A continuous infusion of Saffan has been successfully used during MRI to investigate cerebral ischemia in *C. jacchus* (Whelan et al., 1999). In this study, the average steady-state infusion of Saffan 27.7 mg/kg/h for females and 25 mg/kg/h for males coupled with endotracheal intubation and ventilation produced safe, easily controlled anesthesia suitable for long-duration imaging. Ventilation was used to prevent hypoxia and hypercapnia associated with respiratory depression. Recovery in the animals anesthetized by continuous infusion lasted a mean of 1.35 hours. Marmosets were fully recovered by 3 hours, with no obvious adverse effects (Whelan et al., 1999). It should be noted that in *S. sciureus*, respiratory depression and hypothermia accompanies Saffan anesthesia.

For positron emission tomography (PET) imaging, induction in *Papio anubis* was achieved with a single injection of Saffan 8–10 mg/kg IM, and anesthesia was maintained throughout the study by a continuous IV infusion of 6–9 mg/kg/h (Villemagne et al., 1998). Continuous infusion of Saffan has been also reported in *Erythrocebus*. Up to 4 hours of anesthesia was provided by continuous IV infusion of Saffan at a dosage of 0.14 mg/kg/min in *E. patas*. In these animals, the heart and respiratory rates dropped by as much as 62 and 40%, respectively, in animals breathing air, and by 25% in those breathing oxygen (Dhiri, 1985). It was found to be reliable with a smooth and rapid induction.

C. Propofol

Propofol provides a smooth induction with adequate muscle relaxation sufficient for procedures of short duration. Because rapid clearance of propofol contributes to a relatively fast awakening, repeated boluses of 2–5 mg/kg IV can be administered to extend the duration of anesthesia without delaying recovery.

A noticeable side effect of propofol is the occurrence of apnea, at the higher doses following an induction dose. A slow induction will minimize this respiratory effect of the agent. Several clinical reports have been made on the use of propofol in macaques. In *M. fascicularis*, the duration of anesthesia varied from about 5 to 40 minutes with propofol dosages of 2.5–10 mg/kg IV. A dosage of 2.5 mg/kg given repetitively, as needed, provided adequate anesthesia for laparoscopy. Apnea for 1–2 minutes occurred immediately after administration at dosages exceeding 5 mg/kg. Based on the results obtained by bolus administration of propofol, the authors of this report suggest that an infusion rate of 0.3–0.4 mg/kg/min would be sufficient in macaques (Sainsbury et al., 1991).

Fanton et al. (2000) studied cardiovascular responses to propofol in rhesus monkeys. Intravenously administered induction doses of propofol (2 mg/kg of body weight, followed by continuous infusion of propofol 0.2 mg/kg/min) resulted in significant decreases in blood pressure, heart rate, and myocardial contractility. These changes were accompanied by an increase in systemic arterial compliance. Only minimal changes in left ventricular diastolic pressure, cardiac output, and stroke volume were observed in this study.

In contrast, Hom et al. (1999) found that propofol anesthesia resulted in elevated heart rate when compared to conscious, unrestrained *M. mulatta*. Similar to the previous study, mean arterial blood pressure was lower in animals anesthetized with propofol. Hematology, serum chemistry, and blood gasses were unaffected. However, because of its formulation, propofol was inappropriate for use in animals in which studies of triglyceride levels were conducted.

In the authors' experience, propofol given at a dosage of 2–4 mg/kg provides smooth induction with adequate muscle relaxation in macaques and *Papio* species; it is sufficient for procedures of short duration (e.g., catheter placement, wound suturing, and radiography) or as an induction agent for inhalational anesthesia. Because rapid clearance of propofol contributes to a relatively fast recovery, repeated boluses of 2–4 mg/kg IV can be administered to extend the duration of anesthesia. Alternatively, maintaining animals on a continuous infusion of propofol (0.2–0.4 mg/kg/min) provides reliable sedation for the imaging procedures such as MRI or PET, which require no movement for prolonged periods of time. Benveniste et al. (2003) reported that pregnant *Macaca radiatta* was successfully maintained on propofol infusion of 0.16–0.3 mg/kg/min for PET and MRI to identify fetal organs and to measure maternal and fetal isotope distribution and perform whole-body imaging for up to 7 hours. However, Fowler et al. (2001) found that *M. mulatta* required higher dose of propofol infusion to maintain animals sedated during MRI. Propofol infusion ranged between 0.31 and 0.64 mg/kg/min, with a mean value of 0.51 mg/kg/min during 60-minute scan. Authors also noted large individual variations in the dose response to propofol that revealed no relationship between physiological parameters or body weight. None of the animals developed hypoxemia or cardiovascular instability.

Ouchi et al. (2006) evaluated effects of a low dose (12 mg/kg/h) and high dose (25 mg/kg/h) of propofol with 65% nitrous oxide, under normothermic temperatures and mildly hypothermic conditions; cerebral metabolism, cerebral blood flow (CBF), and their regional coupling were determined through direct measurement by positron emission tomography. The authors concluded that propofol and mild hypothermia (35°C) have an additive effect on metabolism, and can be considered safe, because none of the combinations impaired the coupling of cerebral metabolism and blood flow.

An effective dosage in *P. troglodytes* is 1–2 mg/kg as an initial bolus followed by maintenance by propofol infusion. This provides anesthesia for procedures of short duration, and a recovery that is smooth and rapid (Swenson, personal communication, 1995).

Unlike other IV agents, propofol is formulated in an emulsion of soybean oil, glycerol, and egg lecithin, which readily supports bacterial growth. Since refrigeration is not recommended by the manufacturer, multiuse of propofol vials provides a sufficient time and environment for microbial replication. Accordingly, it is important that sterile technique be practiced when this agent is used in nonhuman primates (Bennett et al., 1995).

D. Barbiturates

1. Pentobarbital

Prior to the general use of inhalant anesthetics in veterinary medicine, pentobarbital was routinely used to anesthetize nonhuman primates. The major difficulties with pentobarbital are severe respiratory depression at high dosages necessary for adequate anesthesia, inability to modulate the depth of anesthesia well, and a very long period of recovery.

The usual dosage in nonhuman primates is 20–30 mg/kg IV; however, there may be considerable variation among animals. Pentobarbital anesthesia is induced by delivering approximately one-half the calculated dosage as a bolus, and then delivering additional amounts to effect. The duration of surgical anesthesia will vary between 30 and 60 minutes. Usually, animals have been chemically restrained with ketamine prior to administration of pentobarbital, and this may reduce by about one-third the needed dosage of pentobarbital required to achieve surgical anesthesia. There are applications for which pentobarbital may be useful. These include some neurosurgical procedures, because pentobarbital induces minimal changes in CSF pressure and decreases CBF and metabolic rate (Branston et al., 1979). The administration of pentobarbital (20–25 mg/kg over 10–15 minutes) in rhesus monkeys significantly reduced ($p < 0.05$) basal mean arterial blood pressure. This is due to venodilation, as well as a decrease in myocardial contractility (Hom et al., 1999).

Pentobarbital may also be appropriate for long-term, non-survival procedures that do not require deep anesthesia with concomitant analgesia.

The effect of pentobarbital anesthesia on respiratory and heart rates, and body temperature, was studied in adult *M. fascicularis* anesthetized for 3–9 hours during neurosurgical studies (Zola-Morgan and Micheletti, 1986). After ketamine induction, the animals were given an initial bolus of pentobarbital IV at a mean dosage of 11 mg/kg. This was followed by additional periodic boluses to effect throughout the procedures. The mean recovery period was more than 3 hours.

2. Thiopental

This ultra-short-acting barbiturate is commonly used to facilitate intubation prior to induction of anesthesia with inhalation agents at 10–15 mg/kg IV; the dosage is less (5–7 mg/kg) if the animal has received ketamine.

Slow infusion of thiopental at 15–17 mg/kg/h has been reported to provide satisfactory chemical restraint and stable physiological baseline values for 90 minutes in *Papio ursinus* with animals recovered within 20 minutes after discontinuation of the infusion (Goosen et al., 1984). This rate of infusion resulted in lower heart rate, slower respiration, and a moderate decrease in body temperature. Of interest is that mean arterial blood pressure did not differ from the values obtained from awake animals. Administration of thiopental typically produces a modest reduction in blood pressure due to peripheral vasodilation, reflecting barbiturate-induced depression of the vasomotor center and decreased sympathetic nervous system outflow (Stoelting and Miller, 1994a). The unaffected blood pressures observed in these baboons may be partially explained by the fact that they were given a slow infusion rather than being induced with a bolus of thiopental.

Thiobarbiturates induce splenic engorgement, and should not be used in patients requiring splenectomy (Ko, 2006).

E. Opioids

Opioids have been used in nonhuman primates to reduce the minimal alveolar concentration of inhalational anesthetic and to enhance intraoperative analgesia during balanced anesthesia. The main advantage of high-dose opioid anesthesia is that it does not seriously impair cardiovascular function, and effectively suppresses sympatho-nervous system responses to surgical stress (Sofianos et al., 1985). Among the opioids available, buprenorphine is the most commonly used in nonhuman primates for postoperative analgesia, and fentanyl is most often used as the analgesic component for balanced anesthesia.

In the authors' experience, fentanyl is a valuable supplement to inhalational anesthesia for cardiovascular and neurosurgical procedures in Old World primates. For cardiac surgeries, it can be administered either as a bolus (5–10 µg/kg) or as a continuous infusion (10–25 µg/kg/h) in combination with low minimum alveolar concentration (MAC) isoflurane with minimal effects on heart rate and blood pressure. For neurosurgical

procedures, fentanyl dose can be increased from 50–70 $\mu\text{g}/\text{kg}/\text{h}$ to 70–100 $\mu\text{g}/\text{kg}/\text{h}$ during maximum nociceptive stimulation, with isoflurane maintained between 0.2% and 0.5%. This combination permits maintenance of blood pressure, central venous pressure, cerebral perfusion pressure, and core body temperature at constant levels throughout the operative procedure. The reduction in blood pressure and bradycardia associated with opioid infusion is usually dose-dependent. In *M. mulatta* (Nussmeier et al., 1991), fentanyl produced minimal changes in MAP, cardiac output, pulmonary and central venous pressures, and systemic vascular resistance in doses not exceeding 16 $\mu\text{g}/\text{kg}$ IV; a 30% decrease in mean arterial blood pressure was only evident after 64 $\mu\text{g}/\text{kg}$. Increasing doses of morphine up to 1 mg/kg IV in *S. sciureus* resulted in maximum decrease in mean arterial blood pressure by 15 mmHg from baseline values (Dourish et al., 1990).

Similar to humans, respiratory depression is detectable in nonhuman primates after relatively small doses of narcotic analgesics. Morphine, given at dosages of 0.125–1.0 mg/kg to *S. sciureus*, resulted in dose-dependent reduction in respiratory rate, arterial pO_2 , and elevation in arterial pCO_2 (Dourish et al., 1990). A significant decrease in respiratory rates was observed in *M. mulatta* after a 2 $\mu\text{g}/\text{kg}$ fentanyl dosage, whereas PaCO_2 increased significantly after 4 $\mu\text{g}/\text{kg}$ and apnea occurred after a 64 $\mu\text{g}/\text{kg}$ fentanyl bolus (Nussmeier et al., 1991). Reversal of opioid-induced respiratory depression is achieved with naloxone, 0.01 mg/kg IV. Naloxone should be administered in nonhuman primates before extubation to counteract any elevation of PaCO_2 induced by opioids.

The analgesic and respiratory effects of other potent opioids in macaques were evaluated. Ko et al. (2002) compared effects of three opioids (alfentanil, fentanyl, and remifentanil) on duration of action on reinforcing effects. Similar to humans, an IV bolus of alfentanil (3–32 $\mu\text{g}/\text{kg}$) and ultra-short-acting remifentanil (3.2–5.6 $\mu\text{g}/\text{kg}$) had shorter duration of analgesia than IV fentanyl (3–32 $\mu\text{g}/\text{kg}$). In particular, 16 $\mu\text{g}/\text{kg}$ IV fentanyl produced analgesia that lasted 60 minutes. Analgesia produced by alfentanil at the same doses lasted for approximately 15 minutes and remifentanil's maximal effect was transient, lasting for less than 15 minutes. The onset of action did not differ among the three μ agonists. IV fentanyl administration produced a dose-related depression of respiration as assessed by reduction in minute volume that at the highest administered dose returned to control values at 60 minutes. Although remifentanil was also effective in suppressing minute volume, animals were breathing at a normal volume within 10 minutes of drug administration. Alfentanil had an intermediate effect on respiratory depression. It appears that ultra-short-acting effects of remifentanil may be useful in SP in which it can be administered by continuous infusion in combination with other short-acting agents such as propofol.

Sufentanil citrate, a potent opioid agent, was used as an IV infusion at the rate of 6–30 $\mu\text{g}/\text{kg}/\text{h}$ in 5% dextrose solution for mapping of the visual receptive fields in rhesus monkeys.

Sufentanil infusion produced light stage of anesthesia as judged by intermediate-amplitude electroencephalogram (EEG) waveforms. In combination with muscle relaxant, vecuronium 0.1 mg/kg/h, this allowed to record spatial frequency response functions for each cone separately that lasted on average for 4–5 days. All SP were conducted before paralysis to monitor animal response to placement of recording electrode (Johnson et al., 2004).

F. Etomidate

Etomidate has not been widely used in nonhuman primates. Cardiovascular stability seen with this anesthetic in humans could offer an attractive alternative for procedures that require minimal effects on the animal's hemodynamics. However, 1 mg/kg etomidate followed by etomidate infusion of 100 $\mu\text{g}/\text{kg}/\text{min}$ produced significant reduction in aortic systolic, diastolic, and mean pressures in macaques (Fanton et al., 2000). Only minimal changes in cardiac output or stroke volume were noticed in this study. In view of animal's ability to maintain cardiac output, a decrease in total peripheral resistance may account for the decrease in MAP.

Etomidate does not provide adequate analgesia for painful procedures and its ability to suppress adrenal function during anesthesia and surgery may be detrimental in immediate postoperative period. In addition, popularity of propofol during imaging and noninvasive procedures has limited the use of etomidate for research in nonhuman primates.

G. Muscle Relaxants

Muscle relaxants are not anesthetics or analgesics and should only be used in fully anesthetized animals. Used as an adjunct in adequately anesthetized nonhuman primates, they can facilitate mechanical ventilation and reduce skeletal muscle tone during surgery. The authors use pancuronium (0.08–0.1 mg/kg IV) and vecuronium (0.04–0.06 mg/kg IV) to produce muscle relaxation during maintenance of inhalational anesthesia. Pancuronium is a long-acting muscle relaxant. It produces a moderate elevation in heart rate and blood pressure, and we have found that these effects are desirable in hypovolemic and bradycardic nonhuman primates. Vecuronium, on the other hand, has no hemodynamic effects and is a viable alternative to pancuronium in cardiovascular procedures.

The interaction of ketamine with commonly used nondepolarizing neuromuscular relaxants has been evaluated in adult *Macaca cyclopis* monkeys anesthetized with 0.5–1% halothane (Tsai and Lee, 1989). IV infusion of either d-tubocurarine, atracurium, vecuronium, or pancuronium was done to provide a steady depression of the thumb twitch for 15 minutes at 50% of baseline. The effect of ketamine on thumb twitch was done at three dosage levels (2, 5, and 10 mg/kg IV). In a dose-dependent manner, except for pancuronium at 2 mg/kg, ketamine

significantly increased the 50% depression of the thumb twitch values for each of the four muscle relaxants. The maximum potentiation induced by ketamine occurred within 5–15 minutes, and the average duration of effect associated with pancuronium was 1 hour; lesser durations occurred with the other three agents. Ketamine, in the absence of the four neuromuscular relaxants, had no neuromuscular blocking effects. It has also been shown that ketamine potentiates the Phase I and Phase II neuromuscular blocks of succinylcholine in *M. cyclopis* monkeys (Tsai et al., 1989).

VI. INHALATIONAL ANESTHESIA

A. Induction

Induction of anesthesia in most nonhuman primate species is usually initiated with ketamine (5–10 mg/kg IM) or tiletamine–zolazepam (3.5–5.0 mg/kg) sedation to provide chemical restraint and IV access. Thiopental is commonly used as an induction agent for inhalational anesthesia. This is usually given at a dosage of 3–5 mg/kg IV as a bolus, followed by additional amounts to effect. The authors have also found that propofol given at 2–5 mg/kg IV as a bolus followed by additional amounts to effect provides for a very satisfactory and smooth induction in macaques and *Papio* spp. Once induced, the animal can be easily intubated and the inhalational agent administered.

B. Intubation

The method of choice for delivery of inhalational anesthetics to nonhuman primates is via an endotracheal tube. This ensures a patent airway, delivers gas anesthetics while preventing environmental contamination, and provides an anesthetist with the ability to directly ventilate the animal. Endotracheal intubation has been described in larger nonhuman primates using commercially available equipment and, with proper positioning of the animal, is a straightforward procedure (Fortman et al., 2002). Popilskis prefers preoxygenation with 100% oxygen for 1 minute via a tight-fitting facemask in a spontaneously breathing animal. This prevents desaturation in animals with compromised airways or respiratory failure following apnea. Nonhuman primates should be adequately anesthetized to prevent vagally mediated reactions such as laryngospasm and bradycardia. Endotracheal intubation can be accomplished with the animal in either the supine or prone position. Placing the animal in a sitting position with its head extended toward the anesthetist has been found by to be useful during intubation of pediatric baboons or macaques. Hyperextension of the atlanto-occipital joint facilitates placement of endotracheal tubes in the supine position. Intubation of animals in the prone position requires elevation of the head with the neck overextended. The ultimate goal of both techniques is to achieve the widest

inter-incisor gap for good visualization of the glottis. Endotracheal tubes of various sizes are used for old world nonhuman primates, ranging from 3.0 mm to 8.0 mm. In general, cuffed Murphy endotracheal tubes are chosen, but uncuffed Murphy or Cole tubes are preferred for young or small primates. Endotracheal tubes should be passed with the help of an appropriate laryngoscope. The tracheal tube should be inserted to a depth of at least 2 cm after the disappearance of the tracheal tube past the vocal folds to approximate placement in the mid-trachea. The cuff on the endotracheal tube is carefully inflated to prevent leaks when the animal is ventilated with an Ambu bag. Alternatively, the endotracheal tube is connected to an anesthetic breathing bag that is gently squeezed to a pressure of 15–20 cm H₂O. This allows for bilateral auscultation of the animal's chest for lung sounds. The tube is then secured with cotton gauze to the back of the animal's head.

As an alternative to face masks and endotracheal tube intubation, a laryngeal mask airway (LMA) is commonly used in human medicine, and has been used successfully in macaques and chimpanzees (Hill et al., 2001). The LMA is a reusable device that is inserted into the soft palate and rests in the inferior recess of the hypopharynx above the esophageal sphincter, and against the base of the tongue. It does require closer position monitoring than an endotracheal tube since it can shift placement during the procedure. Since most nonhuman primates are sedated with ketamine or Telazol, the gag reflex remains and endotracheal intubation can cause laryngospasms. Therefore, the LMA is minimally stimulating, since it does not pass into the trachea, and is preferred over the mask for gas inhalation, since the tongue and saliva can partially obstruct the airway. The LMA can even be used to maintain an open airway in a sedated animal that has difficult airways, that is, obese animals.

Endotracheal intubation of smaller primate species, the common marmoset (*C. jacchus*) and the squirrel monkey (*S. sciureus*), has been described in detail (Morris et al., 1997). For larger small primates such as squirrel monkeys, a 1.5 mm cole neonatal endotracheal tube can be used. For larger marmosets, infant-feeding catheters (6–8 French gauge) can be used. For very small primates, a 5 French gauge red rubber urinary catheter is utilized. It is important to measure the length of the feeding catheter and cut it to the length that it should end mid-way between the larynx and bifurcation of trachea. The critical factor for successful intubation is correct positioning. One hand of the assistant holds the monkey's head, grasping the zygomatic arch each side of the head, and simultaneously lifting the animal head vertically such that the nares point as vertically as possible. The other gently supports the animal's body. The anesthetist opens the mouth so as to expose the pharynx. A local anesthetic may be necessary to prevent laryngospasm if animal is not deeply anesthetized. A cotton tip applicator is used to press down on the tongue to maximize exposure of the larynx. Good lighting aids visualization. In larger squirrel monkeys, a pediatric laryngoscope (straight size 1 Miller blade) may be used. With a cotton tip applicator depressing the tongue, the

endotracheal tube is advanced toward the larynx and into the trachea. The proper placement of the tube is confirmed by bilateral movement of the chest with manual compression of the reservoir bag of a nonbreathing circuit such as the Bain system.

C. Nitrous Oxide

Unlike the potent volatile anesthetics, nitrous oxide has a relatively high MAC, 200% in macaques versus 105% in humans, and this prevents its use as a complete surgical anesthetic. Nitrous oxide is sometimes used in combination with other volatile anesthetics such as isoflurane and halothane because it allows for a lower inhaled concentration of either agent. Tinker et al. (1977) demonstrated that the MAC of halothane in *M. fascicularis* was reduced from the mean of 1.15–0.75% when halothane was supplemented with 30% nitrous oxide. The advantage for inclusion of nitrous oxide with other potent volatile anesthetics is a less pronounced circulatory depression, which may be seen with sole administration of isoflurane or halothane. The minimal cardiovascular effects produced by nitrous oxide can be attributed to its stimulatory effects on the sympathetic nervous system, characterized by slight elevations in heart rate, and systemic and pulmonary arterial pressures. In humans, this sympathomimetic effect of nitrous oxide is most evident when it is used together with halothane and, to a lesser degree, with isoflurane (Stoelting and Miller, 1994b).

The authors do not routinely use nitrous oxide in nonhuman primates; however, when it is employed we use 50–70% inhaled nitrous oxide and 30–50% oxygen, with the remaining anesthetic requirement being provided by either 0.8–1.25% isoflurane or 0.5–1.0% halothane in *Papio* spp. and macaques. Because of the rapid elimination of large volumes of nitrous oxide from the blood into the alveoli with a consequent diminution in alveolar oxygen concentrations, diffusion hypoxia may occur if an animal is allowed to breathe air at the end of anesthesia. We administer 100% oxygen for at least 5 minutes at the end of anesthetic administration to prevent this occurrence. McCully et al. (1990) reported a similar anesthetic regimen in *M. mulatta* using 0.5–1.0% halothane plus a 1:1 ratio of nitrous oxide to oxygen at a total flow rate of 4 L/min. Nitrous oxide produces a second gas effect when administered concomitantly with volatile anesthetics and as such accelerates the induction. Induction in nonhuman primates can be augmented by allowing the animal to spontaneously breathe 1.5–3.0% halothane supplemented with 50–60% inspired nitrous oxide. The drawback to this technique is the increased risk of personnel being exposed to waste anesthetic gases.

D. Halothane

Although halothane has been used in nonhuman primates for several decades, and has proven to be, in most applications, a

relatively safe and effective inhalational agent, its production in the United States has been recently discontinued. The MAC of halothane in various species of primates has been determined (Tinker et al., 1977). There seems to be some variance in MAC of halothane, even between closely related species of nonhuman primates. For example, in *M. arctoides*, the MAC of halothane is 0.89% (Steffey et al., 1974a, 1974b), but in *M. fascicularis* it is 1.15% (Tinker et al., 1977).

Cardiovascular effects of halothane have been well documented in nonhuman primates. The noticeable effect of halothane on the cardiovascular system is a decline in systemic blood pressure and heart rate proportional to the depth of anesthesia. Ritzman et al. (1976) reported that increasing halothane MAC from 1 to 1.5 resulted both in a significant decrease in blood pressure and a reduction of heart rate in *M. mulatta*. MAP declined 40–50% and cardiac output was reduced 20–60% when halothane was increased from 1 to 2 MAC. This dose-dependent cardiovascular depression seems to be greater in macaques than in other species, and is due to the direct effect of halothane on myocardial contractility (Steffey et al., 1974a, 1974b). Substitution of nitrous oxide for equipotent levels of halothane tends to blunt this response.

Halothane sensitizes the heart to the dysrhythmogenic effects of epinephrine. The dysrhythmogenic effect of halothane is not dose-dependent and there is no association between initiation of dysrhythmia and type or duration of surgical manipulations. Care should be taken to avoid hypoventilation that may result in hypercarbia and increase the occurrence of ventricular premature contractions (Sanders et al., 1991).

Halothane usually produces rapid and shallow breathing. A progressive respiratory acidosis prevails, which may lead to higher serum potassium levels (Goosen et al., 1984). Providing ventilatory support and lowering inspired concentration of halothane by supplementing it with nitrous oxide will counteract these effects.

Halothane causes a dose-dependent increase in CBF and cerebral vasodilation. In *M. nemestrina*, the autoregulation of CBF begins to fail at 1.0%, end-tidal, with complete loss occurring at 2.0% halothane anesthesia. Administration of 2.0% halothane was associated with a maximum increase in CBF by 97% from the baseline value. Morita et al. (1977) noted that impaired CBF autoregulation renders the brain highly sensitive to changes in cerebral perfusion pressure. Because this may also have a potentially adverse effect on intracranial pressure (ICP), halothane should be used with caution for neurosurgical procedures.

Eng et al. (1975) investigated the effects of halothane anesthesia on maternal and fetal hemodynamics in pregnant *M. mulatta*. As expected, at 1.5% halothane, the maternal blood pressure and cardiac output were reduced with a consequential reduction in uterine blood flow. A decrease in uterine blood flow and the direct effect of halothane-induced depression on the fetal cardiovascular system resulted in a 20% reduction in both fetal blood pressure and heart rate. There were pronounced fetal acidosis and hypoxia in some fetuses. Similar results were

reported in pregnant *M. mulatta* in which serious hypotension frequently occurred (Sanders et al., 1991). These data, as well as the authors' personal observations with macaques and *Papio* spp., suggest that systemic blood pressure monitoring should be instituted during experimental procedures in pregnant nonhuman primates. Careful attention to the depth of anesthesia, positioning of the animal, and intraoperative fluid management will minimize maternal and fetal cardiovascular depression.

Renal perfusion and glomerular filtration may be decreased secondary to a decline in blood pressure and cardiac output produced by halothane. This may affect radiorenography studies due to the delay in excretion of various isotopes and contrast materials (Dormehl et al., 1984).

The controversy concerning the role of halothane in the production of hepatic necrosis was investigated in *E. patas* (Fleming and Bearchroft, 1966). They were able to show that despite multiple and frequent, albeit relatively short duration exposures, halothane was not a specific hepatotoxin in this species.

E. Isoflurane

Isoflurane is a widely used inhalational agent in nonhuman primates, and the anesthetic of choice of the authors for most applications. An advantage of isoflurane over halothane is that it is minimally metabolized due to its chemical stability and low solubility, and accordingly exhaled essentially unchanged (see Chapter 3). This characteristic makes it a particularly safe agent if the nonhuman primate has hepatic or renal deficits, or if the research objective is compromised by an agent that has potentially noxious metabolites. Cook and Clarke (1985) used isoflurane in a *Gorilla gorilla* that had cholestatic jaundice and found that all hepatic function data remained stable throughout the period of anesthesia.

Isoflurane, unlike halothane, does not sensitize the myocardium to the arrhythmogenic properties of circulating catecholamines. Heart rhythm is stable with isoflurane, and based on the authors' experience, ectopic cardiac beats are very uncommon in normocapnic nonhuman primates. Isoflurane produces minimal depression on cardiac output, but there is a dose-dependent decrease in blood pressure due to reductions in systemic vascular resistance. The hypotension is especially pronounced if isoflurane is mask-induced at inspired concentrations of 3–4% or when animals are maintained at or above 2%. Inclusion of fentanyl attenuates the decrease in blood pressure associated with isoflurane. In young animals, isoflurane-induced hypotension most likely reflects unrecognized hypovolemia.

The MAC value for *M. fascicularis* is 1.28% (Tinker et al., 1977). Maintaining nonhuman primates at about 1.3 MAC (1.6–1.75%) provides satisfactory anesthesia for most surgical applications. Although the authors are unaware of controlled studies done to determine the effects of various concentrations of nitrous oxide on the MAC of isoflurane in nonhuman

primates, we would anticipate that the MAC of isoflurane would be about 1.0% with 60–70% nitrous oxide.

Isoflurane is recommended for extended (>1 hour) anesthesia in squirrel monkeys, as well as for compromised animals. Squirrel monkeys may be mask induced with isoflurane (4–5%, less for compromised animals), under manual restraint. Induction usually takes less than 2 minutes, and maintained at 0.5–3.0% isoflurane/O₂ (Brady, personal communication, 2007). In *Galago* spp., ketamine, 10–15 mg/kg IM, may be used for sedation to allow for placement of a mask for delivery of isoflurane, initially at 3.0% and then reduced to about 1.5% for maintenance.

Alternatively, balanced anesthesia consisting of 0.5–0.7% isoflurane and fentanyl titrated to achieve an appropriate depth of anesthesia may be used in nonhuman primates. This inhalational and opioid combination is useful when cardiovascular stability is needed for a procedure. It is important to note that cardiovascular sparing effects are attributable to a reduction in the dose of inhalant anesthetics because opioids are generally devoid of hemodynamic effects. A transient but clinically important decrease in heart rate and MAP was observed with fentanyl administration (8 µg/kg) when end-tidal isoflurane concentration was maintained at 1.2% in rhesus monkeys (Valverde et al., 2000).

Isoflurane effects on brain metabolism and CBF have been investigated in rhesus monkeys (Enlund et al., 1997). Because isoflurane can induce dose-dependent hypotension with concomitant hypocapnea, cerebral oxygenation and blood flow may be affected during hemodynamic instability. As expected, Enlund et al. (1997) noted that CBF was reduced during isoflurane-induced hypotension; and while cerebral metabolic rate of oxygen decreased globally in a dose-dependent manner, this led to a higher oxygen extraction ratio in rhesus monkeys. The authors concluded that, although isoflurane-induced hypotension reduced CBF, it did not result in hypoxia.

F. Sevoflurane

Sevoflurane has minimal odor, no pungency, and is a potent bronchodilator (Barash et al., 2006). These attributes make sevoflurane an excellent candidate for administration via the face mask on induction of anesthesia. It offers an advantage over isoflurane mask induction in nonhuman primates. Lower pungency and airway irritation may lessen the risk of struggling and the associated potential for injury to the animal or anesthetist.

MAC for cynomolgus monkeys has been determined as 2% (Soma et al., 1988). It has been shown to be unstable when exposed to soda lime. This instability was a concern because of potential nephrotoxicity for nonhuman primates (Iyer and Anders, 1996). However, multiple administration of sevoflurane to cynomolgus monkeys did not detect any adverse effects on the animal's renal function (Soma et al., 1995). In this study,

cynomolgus monkeys were anesthetized with sevoflurane at 1, 1.6, and 2 times the MAC for 3 h/day and 3 days/week for 8 weeks. Reduction in total erythrocyte and leukocyte counts and increase in serum enzymes [aspartate aminotransferase (AST), alanine aminotransferase (ALT), lactate dehydrogenase (LDH), and creatine kinase (CK)] were the only changes noted. A significant reduction in red blood cell (RBC) was already noted at 1 and 1.6 MAC sevoflurane at 6 and 8 weeks and in leukocyte count at 1.6 and 2 MAC at 8 weeks. The increases in the serum enzymes occurred at week 1 at all three concentrations of sevoflurane. These increases were dose-dependent and returned to baseline values by week 2 in the lowest MAC group. The multiple administration of 1.0 and 1.6 MAC sevoflurane anesthesia was well tolerated by monkeys; however, at 2.0 MAC some deaths occurred. With the exception of the reduction of the thymus in the anesthetized monkeys, there were no gross, histopathologic, or ultrastructural changes found in any of the groups of monkeys.

As with other inhalant anesthetics, sevoflurane causes a dose-dependent increase in CBF, and in *M. mulatta* the autoregulation of CBF is compromised at 2.0% sevoflurane anesthesia (Kaneko et al., 1997). However, the degree of change is less than that with halothane.

VII. INTRAOPERATIVE MONITORING

Intraoperative monitoring provides the means to assess physiological function during anesthesia and ascertain the proper functioning of anesthetic equipment. It allows prompt recognition of adverse reactions and improves the effectiveness of therapeutic interventions. However, the use of monitoring equipment is intended to enhance but not substitute for the awareness on the part of the anesthesiologist.

A. Cardiovascular Monitoring

In larger nonhuman primates, insertion of an esophageal stethoscope during the intraoperative period facilitates early detection of changes in heart rate and rhythm, and provides information on the adequacy of ventilation. Lead II is commonly used for detection of cardiac dysrhythmia, because it produces an easily recognizable P wave and establishes the relationship of atrial to ventricular depolarization. Arterial blood pressure can be measured by placing the cuff on the nonhuman primate's lower arm or leg. Utilizing a self-calibrating device allows for automatic and noninvasive determination of blood pressure.

Direct arterial pressure monitoring is achieved by percutaneous cannulation or cutdown of the femoral artery in smaller nonhuman primates. To cannulate the femoral artery, we insert an 18-gauge catheter in animals over 10 kg and a 20 gauge Teflon[®] catheter for smaller macaques. To avoid accidental

displacement of the arterial catheter during the procedure, we routinely catheterize the femoral artery using the Seldinger technique. The catheter-over-the-needle (Angiocath[®]) is used for percutaneous cannulation of the femoral artery. The skin at the cannulation site is pierced with the catheter's stylet to facilitate advancement of the catheter and prevent a skin plug from occluding the stylet. After obtaining pulsatile blood flow from the cannulation site, a stylet is removed and a guide wire is placed through the catheter and into the vessel. The catheter used for monitoring is then threaded over the wire into the artery. Placement of a three-way stopcock between the catheter and the arterial tubing allows for frequent blood sampling to determine arterial blood gases. Direct arterial pressure monitoring is usually reserved for animals with cardiac and respiratory dysfunctions, and complex SP such as extracorporeal bypass, which may produce vascular volume deficiencies.

Assessment of central venous pressure is useful in the management of fluid replacement. The external jugular vein is easily accessible and therefore is the most common site for cannulation. A 20 gauge polyurethane indwelling catheter is well suited for medium- and larger-size macaques and *Papio* spp. Following initial cannulation, a J-wire is inserted through the catheter and advanced into the central vein. It is used as a guide for the placement of a longer venous catheter. Cannulation of the internal jugular vein usually requires a cutdown. Measurements of cardiac output and calculation of systemic and pulmonary vascular resistance can be obtained with a pulmonary artery catheter (Swan-Ganz). We find the Swan-Ganz catheter essential for assessment of cardiac function, preload volume status, and responses to therapeutic interventions during major cardiovascular surgery. Placement of the pulmonary artery catheter into the right internal jugular vein represents the most direct approach to the right heart. Catheterization via the femoral vein is also commonly performed, but usually requires fluoroscopic guidance. A 5 French pediatric Swan-Ganz catheter can be successfully inserted in adult macaques (4–8 kg), whereas in larger primates (e.g., 15–20 kg baboons), a 7.5 French pulmonary catheter is used. Udelsman et al. (1984) reported that *M. fascicularis* had cardiac output, systemic and pulmonary vascular resistance values (adjusted for basal surface area) similar to those of humans. With few exceptions, we have observed a close correlation of hemodynamic data between *Papio* spp. and humans.

B. Respiratory Monitoring

Assessment of oxygenation and ventilation during administration of anesthetics is essential. The color of the mucous membranes is the simplest method to ascertain adequacy of oxygenation. Quantitative pulmonary evaluation can be achieved by obtaining arterial blood for blood gas analysis or noninvasively with monitors such as pulse oximetry, end-tidal CO₂ monitors, or mass spectrometry. Pulse oximetry provides continuous

measurement of arterial oxygen saturation. We use an infant digit oxygen transducer that can be attached to a nonhuman primate's tongue or ear. The tongue site seems to be less influenced by intraoperative conditions such as hypothermia or hypotension, and therefore we find it preferable to an ear site. For smaller new world primate (NWP) (marmosets), a pediatric finger probe attached to a shaved footpad provides reliable and continuous monitoring of oxygen saturation and heart rate data.

It is well recognized that measurement of expired CO₂ is the single most effective method of determining airway patency and adequacy of ventilation. Monitors for end-tidal CO₂ sample gas from the animal's airway, usually at the site where the breathing circuit is connected to the endotracheal tube. In addition to displaying CO₂ levels, it also generates a CO₂ waveform called a capnogram. The shape of the capnogram provides us with useful information on a variety of conditions such as obstruction of the endotracheal tube and rebreathing of expired gases.

Airway pressure created by assisted or controlled ventilation is measured by a pressure manometer within the airway circuit of anesthesia machine. Peak inspiratory pressures of 15–30 cm H₂O are usually sufficient to expand the lungs. High peak inspiratory pressures are usually indicative of a kinked endotracheal tube, endobronchial intubation, or an insufficiently opened “pop-off” valve. Any of these conditions may lead to barotrauma and eventually result in pneumothorax or subcutaneous emphysema.

C. Depth of Anesthesia

Anesthetic depth is usually assessed by monitoring a variety of parameters. Loss of palpebral and corneal reflexes, degree of muscle relaxation, rate and depth of breathing, and lack of somatic response to surgical stimuli are most commonly used to ascertain adequacy of anesthesia. If muscle relaxants are used during the maintenance of anesthesia, monitoring autonomic responses to surgical events must be done to assess the depth of anesthesia. Increases in heart rate and systolic blood pressure of 20% or more over baseline values can be interpreted as indications of an inadequate depth of anesthesia. Lacrimation and attempts to breathe out of synchrony with a ventilator might also indicate inadequate anesthesia.

The degree of anesthetic depth is crucial to avoiding complications and maximizing experimental success. Traditional signs of anesthetic depth, such as heart rate and blood pressure, may be inadequate, depending on the anesthetic and species. Diverse opinions regarding what constitutes acceptable anesthetic depth exist among human and veterinary anesthesiologists, and an in-depth discussion of this evolving issue is beyond the scope of this chapter. However, researchers should be aware that animal movement during surgical and experimental procedures may not necessarily indicate that the animal is “underanesthetized” from the standpoint of awareness or discomfort (Antognini et al., 2005). Anesthesiologists use “MAC,” the minimum

alveolar anesthetic concentration required to prevent “gross and purposeful” movement. Patients generally lose consciousness and memory at around 0.25–0.4 MAC. Because MAC awake is a fraction of MAC for movement, animals can be anesthetized at depths that produce unconsciousness and amnesia, yet do not abolish movement. As a general guideline, evaluation of the depth of anesthesia should not be reliant upon any single value or observation, but should be based on the integrated assessment of a number of physiological parameters by the anesthetist.

D. Body Temperature

It is not uncommon for a nonhuman primate to lose a significant amount of body heat during anesthesia and surgery. Very young and small-size animals (marmosets and squirrel monkeys) are particularly at risk of becoming hypothermic. Intraoperative monitoring of body temperature is routinely performed by inserting a temperature probe into either the esophagus or the rectum and connecting it to the monitor. The drawback of rectal temperature is that it does not accurately reflect blood or “core” temperature when changes in temperature are very rapid. Deep hypothermia induced for central nervous system surgery is an example that calls for monitoring core temperature by an esophageal probe inserted into the lower third of the esophagus. A tympanic probe placed in the external auditory canal will reflect brain temperature by measuring the temperature of blood perfusing the brain and is useful during cerebral cooling procedures.

E. Urinary Output

Urinary output is a direct indicator of renal function and serves as a useful guide of intravascular volume status. In female macaques and *Papio* spp., bladder catheterization is usually performed by inserting a soft rubber Foley catheter through the urethral meatus, located between two papillary folds posterior to the clitoris, into the bladder and then connecting it into a urinary drainage bag.

VIII. INTRAOPERATIVE SUPPORT

IV infusion of crystalloid solutions during surgery helps to maintain normovolemia necessary for adequate tissue perfusion. Intraoperative fluid and blood loss replacement is usually determined by the site and duration of surgery. For minor procedures in nonhuman primates, administration of isotonic electrolyte solutions such as lactated Ringer's solution at the rate of 5–10 ml/kg/h is sufficient to maintain normal fluid composition. During abdominal surgery, infusion of lactated Ringer's solution at the rate of 15–20 ml/kg/h is needed

to compensate for third-space loss. Because of their small intravascular volumes, marmosets and squirrel monkeys are especially at an increased risk of some electrolyte disturbances. For maintenance in juvenile macaques and baboons, we routinely administer 2.5% dextrose in 0.45% saline at the rate of 5 ml/kg/h.

A urinary catheter should be used to evaluate the adequacy of fluid therapy whenever surgery is prolonged or if significant changes in intravascular volume are anticipated. Minor-to-moderate blood loss can be replaced with crystalloid solutions given in the amounts equal to about three times the amount of blood loss. Monitoring blood pressure and urinary output allows one to determine whether intravascular fluid volume is being adequately replaced.

Significant intraoperative blood loss warrants serial determination of a nonhuman primate's hematocrit. If the hematocrit falls below 20%, we usually administer blood as part of the replacement solution. There is some disagreement on the necessity of cross-matching blood between the same species of nonhuman primates prior to transfusion (Socha et al., 1984). Initial blood transfusions in macaques and *Papio* spp. do not normally cause any of the symptoms associated with an acute transfusion reaction because preformed isoantibodies to erythrocyte antigens are absent (Socha et al., 1982). Autologous blood transfusions can be used in studies where clinically inapparent, but immunologically significant incompatibilities may occur (e.g., organ transplantation). In such instances, we withdraw 10–12% of the nonhuman primate's blood 10–14 days before surgery and place the blood into a blood collection bag (with citrate-phosphate-dextrose as anticoagulant), which is stored at 1–6°C until the day of surgery.

Anesthesia in conjunction with surgery produces a complex and unstable physiological status. Understanding the effects of various inotropes and vasopressors is important for treating alterations of physiological functions during the intraoperative period. We consider phenylephrine to be a drug of choice to treat isoflurane-induced hypotension. A 1–2 µg/kg bolus of phenylephrine, followed by an infusion of 0.5–1.0 µg/kg/min, will elevate blood pressure by increasing systemic vascular resistance. When hypotension is accompanied by bradycardia, a 2.5 mg IV bolus of ephedrine, repeated if needed, will increase blood pressure and improve cardiac output. We have not observed cardiac dysrhythmias in nonhuman primates anesthetized with isoflurane and treated with ephedrine.

An IV bolus of lidocaine, 1.0–2.0 mg/kg, followed by lidocaine infusion, 20–50 µg/kg/min, is helpful in suppressing premature ventricular contractions.

During cardiovascular collapse, characterized by decreased cardiac output and markedly reduced blood pressure, dopamine and norepinephrine infusions can be used. Dopamine has an advantage over other sympathomimetic drugs due to its ability to maintain perfusion pressure and cardiac output without reducing renal blood flow. Infusions of all sympathomimetic drugs should

be prepared in a solution of 5% dextrose in water or alternatively in normal saline.

The use of forced-air warming systems (e.g., Bair Hugger) is a simple and effective means of providing temperature support. Bair Hugger blankets are available in a variety of shapes and sizes to optimize convective warming for the large size range of nonhuman primates encountered in research. Warming of IV fluids generally does not contribute to the maintenance of normothermia. However, if large volumes of fluid are to be administered, this measure is recommended, as it would help to prevent fluid-induced hypothermia.

IX. SPECIAL ANESTHETIC CONSIDERATIONS

A. Obstetric Anesthesia

Physiological changes occurring during pregnancy can directly influence the anesthesia management for obstetric surgery. Increased plasma volume leading to dilutional anemia, increased alveolar ventilation, prolonged gastric emptying, and decreased requirements for inhaled anesthetics are the most common physiological alterations. After ketamine preanesthesia, thiopental (3–5 mg/kg), or propofol (2–5 mg/kg) IV can be used for induction with inhalational agents for maintenance of anesthesia. For maintenance in *Papio* spp., we use 0.5–0.7 MAC of either halothane or isoflurane supplemented with 50–60% inspired nitrous oxide. The advantage of including nitrous oxide with other volatile anesthetics is that there is a less pronounced circulatory depression. Because maternal hypotension is the most common complication encountered during anesthesia, we routinely monitor blood pressure. Indirect blood pressure is monitored with the proper-size cuff placed around the area of the tibial or radial artery. Measuring indirect blood pressure in the arm may not provide correct information due to arterial hypotension occurring only in the lower extremities in the pregnant animal.

Placing the pregnant nonhuman primate in a supine position may contribute to hypotension due to compression of the caudal vena cava and abdominal aorta by the gravid uterus. Tilting the pregnant animal to the left by elevating the right sacral area helps to prevent maternal hypotension. Maternal hypotension from any cause requires immediate volume restoration and, if needed, careful vasopressor therapy. We maintain hydration by IV infusion of lactated Ringer's solution at the rate of 10–20 ml/kg/h. Preoperative placement of a urinary catheter allows for monitoring the effectiveness of fluid therapy. If hypotension persists, we consider vasopressor therapy. Ephedrine, intravenously in 1.25–2.5-mg increments, is the safest vasopressor for use during maternal hypotension. Because of its predominant beta-adrenergic activity, ephedrine will maintain uterine arterial perfusion by increasing maternal cardiac output and restoring uterine blood flow without uterine arterial

vasoconstriction (Levinson et al., 1974). Maternal normocapnea should be maintained during the intraoperative period. Extreme hyperventilation of the lungs should be avoided. In humans, hypocarbia has been shown to reduce uteroplacental blood flow (Stoelting and Miller, 1994a, 1994b). Conversely, hypoventilation during halothane anesthesia has been associated with an increased incidence of premature ventricular contractions in *M. mulatta* (Sanders et al., 1991).

Laparotomy performed on pregnant rhesus monkeys and baboons during the last third of gestation is often followed by pronounced uterine contractions, especially in the first few postoperative days (Morgan et al., 1992; Taylor et al., 1983). This, in turn, may lead to premature delivery. In late pregnancy, myometrial contractions in nonhuman primates occur in two distinct forms: contractures, which are long in duration and accompanied by increases in intra-amniotic pressure; and contractions, which are short in duration and high in amplitude (Tame et al., 1999). It has been suggested by the authors that elevated estrogen levels in pregnant monkeys are responsible for switching from contracture mode to the contraction mode. Close attention to the level of postoperative analgesia may help to reduce postoperative myometrial contraction activity and enhance success after SP in pregnant nonhuman primates. Tame et al. (1999) administered a continuous infusion of buprenorphine at either 15 or 30 $\mu\text{g}/\text{kg}/\text{day}$ for 48 hours through an intra-arterial catheter protected by the tether system. Higher doses of buprenorphine resulted in inhibition of postoperative myometrial contractions, as well as lower maternal estradiol and cortisol concentrations. Similarly, there were decreases in myometrial contractions and maternal plasma catecholamine concentrations with the use of a single injection of epidural morphine (0.15 mg/kg) or a continuous infusion of morphine (0.5 mg/h/day for 48 hours) (Popilskis et al., 1994). Prevention of hypothermia is also an important factor in the anesthesia management for obstetric surgery, particularly for laparotomy procedures. As discussed previously, the use of forced-air warming systems (e.g., Bair Hugger) is recommended, besides warmed fluids if large volumes are to be administered.

B. Pediatric Anesthesia

Successful pediatric anesthesia management requires an understanding of the physiologic and pharmacologic differences between adult and pediatric animals. Cardiac output is heart rate dependent in pediatric animals, since stroke volume is relatively fixed due to the noncompliant left ventricle in young nonhuman primates. The high heart rate makes ECG monitoring difficult with routine electrocardiograph units. Arterial blood pressure is lower than that in adult nonhuman primates. Accurate measurement of blood pressure can be a problem if adult human blood pressure cuffs are used. Popilskis has used pediatric (size one) blood pressure cuffs for 1 kg nonhuman primates with intermittent success.

Therefore, based on physiologic differences, one of the main goals of preanesthesia and induction is the avoidance of heart rate reduction. This can be achieved with administration of ketamine (5 mg/kg) and atropine (0.02 mg/kg) IM. Inhalational mask induction is also an accepted technique in pediatric anesthesia, but because neonatal primates are usually allowed to nurse until anesthesia time, assisted ventilation during mask induction should be avoided. Assisted ventilation may lead to the insufflation of the stomach with gases and place the neonate at risk to aspiration. For the same reason, the authors often induce neonatal primates with propofol (2–4 mg/kg) IV. The suckling reflex is used as one of the indicators for depth of anesthesia in neonatal nonhuman primates. This is done by placing a finger into the neonate's mouth, which elicits sucking. The loss of this reflex serves as a reliable indicator of adequate depth of anesthesia.

Intubation of pediatric nonhuman primates can be done with the use of both uncuffed and cuffed endotracheal tubes. The authors use 2.5–3.5 mm internal diameter endotracheal tubes for neonatal and juvenile *Papio* and *Macaca* spp. The intubation technique has been described previously. Postintubation laryngeal edema is unlikely if the size of the endotracheal tube in the trachea is such that a slightly audible air leak occurs around the tube when positive pressure of 15–20 cm H₂O is applied.

Small tidal volumes in pediatric animals require the use of nonbreathing circuits such as modified Jackson Rees and Bain systems. A fresh gas flow of 1.5–2.0 L/min is adequate to prevent rebreathing during spontaneous ventilation. Because volatile anesthetics depress spontaneous ventilation, we use controlled or assisted ventilation for all but short procedures to prevent CO₂ accumulation. Intermittent positive pressure ventilation (IPPV) can also be provided with a Bain system. In smaller nonhuman primates, IPPV offers an advantage over spontaneous ventilation by providing better ventilation and improving acid–base balance.

We routinely monitor ECG, indirect blood pressure, oxygen saturation, and body temperature in pediatric cases. Indirect blood pressure is obtained by placing a proper-size cuff around the radial artery. The pulse oximetry transducer is best attached to the tongue or to the palm of the hand in the neonate. Pediatric animals have a larger surface area per kg of body weight than adults, resulting in increased heat loss to the environment. This, together with an increased metabolic rate and lack of body fat, increases the potential for significant hypothermia in pediatric nonhuman primates. The use of warming lights, forced-air warming systems (e.g., Bair Hugger) and warm IV fluids minimizes the severity of hypothermia.

We consider isoflurane to be the anesthetic of choice for pediatric animals. It may increase the heart rate slightly; however, a stable rhythm is maintained. The hypotension that accompanies isoflurane anesthesia is not uncommon in pediatric macaques and *Papio* spp. We treat isoflurane-induced hypotension with phenylephrine, and in some cases it may be more effectively treated with a norepinephrine infusion (0.05–0.1 $\mu\text{g}/\text{kg}/\text{min}$).

As a guideline for maintenance fluids in pediatric primates, we use 4 ml/kg/h of warm 5% dextrose or 2.5% dextrose in 0.45% NaCl. This will not correct third-space intraoperative losses and blood loss. Because vasoconstrictive responses of neonates to hemorrhage are less than those of adults, even moderate blood loss will result in precipitous declines in blood pressure. Therefore, crystalloid solution, equal to three times the blood loss, should be immediately given.

In general, we find that neonatal *Papio* spp. and macaques recover more quickly from anesthesia and are less disturbed by minor complications than are adult nonhuman primates.

C. Anesthesia for Laparoscopic and Thorascopic Procedures

Compared to open procedures, endoscopic surgery decreases surgical morbidity due to reductions in incision size, hemorrhage, and procedure time that may lead to prolonged postoperative recovery. In addition, it reduces the number of animals required for certain studies because of the ability to retrieve serial samples (Liao et al., 2004). This, in turn, allows performing minimally invasive procedure on a single animal without the need for an additional animal for each collection point. The endoscopic procedures for various species for nonhuman primates have been described (Gaglio et al., 2000; Liao et al., 2004; Perret-Gentil et al., 2000; Rawlings et al., 2000). For research purposes, it has been performed in baboons to obtain liver and splenic biopsy specimens (Rawlings et al., 2000), in rhesus for study of hepatectomy and liver regeneration (Gaglio et al., 2000), for intra-abdominal biopsy in obese rhesus monkeys (Liao et al., 2004) and serial abdominal tissue samples for HIV studies in macaques (Perret-Gentil et al., 2000).

A majority of laparoscopic procedures are performed under inhalational anesthetic, isoflurane. In addition to routine monitors such as ECG and pulse oximeter, it is advantageous to incorporate capnograph monitor for continuous assessment of end-tidal CO₂. Because pneumoperitoneum is created using CO₂ insufflation, to a pressure of 8–12 mmHg, high abdominal pressure may induce adverse physiologic changes, including retention of CO₂ and reduced visceral perfusion. This especially may be important to older and obese monkeys, with potentially greater medical risks associated with these conditions (Liao et al., 2004). Nevertheless, laparoscopy greatly reduces the likelihood of adhesions that are more common for open SP. In turn, this should allow the animal to return rapidly to normal food intake and activity.

Video-assisted endoscopic surgery has been gaining popularity in nonhuman primates. In the effort to decrease the postoperative morbidity associated with open thoracotomy, Bohm et al. (2000) describe the procedure to collect thymic tissues in rhesus monkeys. After premedication with acepromazine 0.02 mg/kg and butorphanol 0.013 mg/kg IM, anesthesia was

induced and maintained with isoflurane and positive pressure ventilation was instituted throughout the procedure. The port sites were created by making three 1-cm incisions: for endoscopic camera in intercostals space (ICS 6), Babcock forceps (ICS 5), and Metzenbaum scissors (ICS 3). Both Babcock forceps and Metzenbaum scissors were used to create defects in pleura and retract the samples. Insufflation was performed with carbon dioxide at the rate of 2–5 L/min. The authors noted only minor complication such as self-limiting bleeding and avascular adhesions that were easily broken. It should be noted that insufflation pressures should be maintained as low as possible and the CO₂ inflow rate kept preferably less than 2 L/min (Barash et al., 2006). Higher pressures can cause mediastinal shift, hemodynamic compromise, and increase in end-tidal CO₂. Hypotension and tachycardia could be present especially at pressures above 5 mmHg (Sato et al., 2005).

D. Anesthesia for Magnetic Resonance Imaging

MRI techniques have gained popularity because of their non-invasiveness, ability to obtain both biochemical and spatial information without destroying the sample, and lack of ionizing radiation. An inevitable consequence of carrying MRI is the presence of strong magnetic field that may affect anesthesia equipment and various physiological monitors. An additional disadvantage of using MRI techniques, especially functional MRI, is its sensitivity to motion artifact, which creates the need to avoid movement of the animal and thus minimize misinterpretation of data. Reliable sedation and anesthesia is essential to avoid gross movement. Propofol has been successfully used in nonhuman primates to achieve reliable sedation during the imaging. When compared with other injectable anesthetics such as Saffan or etomidate, it offers certain advantages. Saffan is only available in the United Kingdom. Etomidate's ability to suppress adrenal function during anesthesia and surgery may be detrimental in immediate postoperative period. Given the noncumulative nature of propofol, it allows for ease of titration during continuous infusion and rapid recovery. Although propofol provides faster induction and recovery times, it causes desaturation, hypotension, decrease in heart rate, and myocardial contractility (Fantoni et al., 2000; Fowler et al., 2001). MRI-compatible fiber optic pulse oximetry (NONIN, Model 8000FC) offers continuous monitoring of propofol-anesthetized nonhuman primates during imaging procedures. Despite its limitations, it alerts anesthesiologist of potential problems (desaturation, cardiovascular instability, and hypothermia) during limited visualization of the primate in the scanner. Applying assisted ventilation with 100% oxygen supplementation would further assure maintenance of safe anesthesia during imaging procedure.

The usefulness of a continuous infusion of propofol to obtain high-resolution MRIs in 27 *M. mulatta* was demonstrated

by Fowler et al. (2001). Animals were initially sedated with tiletamine–zolazepam and induced with 1 mg/kg propofol IV. Animals were intubated to provide assisted ventilation and supplemental oxygen during transport and imaging procedures. Propofol infusion ranged between 0.31 and 0.64 mg/kg/min, with a mean value of 0.51 mg/kg/min during 60-minute scan. Popilskis noted large individual variations in the dose response to propofol with no correlation to body weight. None of the animals developed hypoxemia as assessed by pulse oximetry and although blood pressure was not measured during the actual imaging, measurements were normal prior to and after the MRI. Because each MRI was followed by the craniotomy and neural transplant surgery under isoflurane anesthesia, accurate assessment of recovery time was not made. Anesthetic recovery from propofol anesthesia in two monkeys without subsequent cranial surgery occurred within 5–10 minutes of stopping the infusion (Fowler et al., 2001).

Benveniste et al. (2003) used propofol infusion to determine methodology for combining PET and MRI to identify fetal organs and to measure bi-directional nutrient exchange and metabolism between dam and fetus *M. radiata*. This presents certain challenges as maternal drug transfer may be hazardous to the fetus, and on the other hand, sufficient transplacental transfer of drugs to the fetus plays crucial role in therapeutic efficacy. Animals were maintained on propofol infusion of 160–300 $\mu\text{g}/\text{kg}/\text{min}$ for anatomic T2-weighted images, with subsequent acquisition of whole-body PET images. All animals underwent uneventful anesthesia for a duration of up to 7 hours. Propofol infusion did not adversely affect isotope distribution across placenta and its accumulation in both maternal and fetal internal organs. In addition, IV propofol, in combination with IV hydration, ensured stable physiological state during long-term imaging study as well as rapid and uncomplicated recovery. None of the pregnant macaques developed preterm labor during or immediately after the study and all mothers delivered normal, full-term babies.

The Popilskis used propofol IV infusion for imaging in *Papio* spp. with various degrees of neurological deficits to characterize stroke lesion evolution. Animals tolerated well propofol infusion of 100–225 $\mu\text{g}/\text{kg}/\text{min}$ at 72 hours postcerebral ischemia. Baboons were intubated and connected to nonbreathing circuit with attached Ambu bag. Supplemental oxygen was provided and pulse oximeter was used to monitor physiological parameters. Propofol was discontinued at the end of the scan and baboons were delivered to the home cage for further monitoring. Because of the neurological deficits related to stroke, the recovery was prolonged (1–1.5 hours) but without anesthesia-related complications.

Recently, MRI-compatible anesthesia machines and monitors became available, but it is still important to check exactly how close this equipment can be brought to the magnetic field. In the absence of MRI-compatible monitors, long sampling tubes can be connected to anesthesia monitors.

E. Anesthesia for Neurological Procedures

Nonhuman primate models of focal cerebral ischemia provide clinically relevant models for investigating the vascular and cellular pathophysiology associated with ischemic brain injury and pharmacological interventions that are appropriate for stroke patients. One of the most relevant and reproducible models is that of *Papio* species, with the transorbital surgical injury to the proximal middle cerebral artery. A majority of animals display both cortical and subcortical injury with animals exhibiting various degrees of neurological deficits. The size of *Papio* makes this species suitable for clinical neurological assessment, computerized tomography and MRI cerebral scanning, neuroelectrophysiologic measurements, and evaluation of neuropathology. These characteristics are important in the development of clinically relevant experiments.

There is currently no widely accepted drug or technique that has been shown to offer brain protection during neurosurgical procedures. Nehls et al. (1987) have compared the effects of isoflurane ($2 \pm 0.5\%$), thiopental (3.6 ± 0.7 g), and nitrous oxide (60%)/fentanyl ($3\text{--}25$ $\mu\text{g}/\text{kg}/\text{h}$) anesthesia on neurological outcome in baboons subjected to middle cerebral artery occlusion. Baboons in the isoflurane group had more frequent infarcts than animals that were maintained on thiopental infusion; their neurological outcome scores were worse. Furthermore, while there were no significant differences between isoflurane and nitrous oxide/fentanyl groups in terms of neurological outcome, there was a significant difference in the character of infarcts, with those in isoflurane group being more hemorrhagic in character.

The use of balanced anesthesia that utilizes combination of high doses of opioid analgesic, low inspired concentration of volatile anesthetic and muscle relaxant provides physiologically stable anesthesia that is important for neurosurgical procedures. An additional and very important advantage of this technique for neuroanesthesia is that it causes minimal changes in CBF and ICP. The use of inhalant anesthetic, that is, isoflurane, as a sole anesthetic produces a dose-dependent decrease in systemic blood pressure that alters CBF and may even worsen an outcome of focal ischemia in baboons (Nehls et al., 1986, 1987).

Popilskis used balanced anesthesia, consisting of a high fentanyl infusion ($50\text{--}100$ $\mu\text{g}/\text{kg}/\text{h}$) with a low MAC of isoflurane ($0.1\text{--}0.5\%$) administered in combination with 60% nitrous oxide in a modified transorbital baboon model of reperfused stroke. Large doses of fentanyl were utilized not only for analgesia and MAC reduction, but also to produce unconsciousness and suppress the usual stress response to surgery. Muscle relaxant, vecuronium (0.04 mg/kg/h IV), was infused during the intraoperative period. Used as an adjunct in adequately anesthetized nonhuman primates, it facilitated mechanical ventilation and reduced skeletal muscle tone. Continuous monitoring of direct arterial blood pressure and heart rate assured timely recognition and immediate correction of inadequate anesthesia.

An intensive physiologic monitoring during neurovascular procedures is key to successful short- and long-term outcome. For this reason, an intra-arterial catheter was placed into the femoral artery to provide for continuous monitoring of blood pressure and multiple arterial blood gas sampling. A mean arterial blood pressure was maintained between 60 mmHg and 80 mmHg. Hypotensive episodes were treated with IV injections of phenylephrine. Central venous pressure was assessed via femoral vein catheter and sustained between 3 mmHg and 7 mmHg. An indwelling, transurethral Foley catheter permitted monitoring of urinary output to guide fluid management and CVP. Respiratory rate and tidal volumes were adjusted to maintain PCO_2 around 35 mmHg. Continuous ICP monitoring was accomplished with a parenchymal sensor (Neuromonitor and Goodman). Monitoring of core body temperatures with an esophageal probe and of the brain with a parenchymal probe (Mon-a-Therm 70B, Mallinckrodt Medical) allowed body temperatures to be maintained close to 37°C with a warm air-heating blanket.

Postsurgical animals remained intubated and sedated (isoflurane 0.4–1% and fentanyl 5–20 $\mu\text{g}/\text{kg}/\text{h}$) for the first 18 hours. This allowed for continuous monitoring of blood pressure, CVP and ICP, core and brain temperatures, and arterial blood gas. Sustained ICP of >20 mmHg was treated with mannitol at a dose of 0.5 g/kg administered IV. Pulmonary evacuation was achieved with suctioning and chest physical therapy. By the end of 18 hours monitoring period, inhalant anesthetics and opioids were tapered and animals were allowed to regain consciousness. Extubation was attempted only if animals demonstrated the ability to maintain normal arterial blood gas ($PO_2 > 60$ mmHg and $PCO_2 < 40$ mmHg) without assisted ventilation.

X. POSTOPERATIVE CARE

Postoperative monitoring ensures prompt recognition of postsurgical complications and helps provide for an overall safe recovery from anesthesia. Physiological disorders most commonly encountered during postoperative recovery include pulmonary and circulatory complications, hypothermia, and pain.

It is not uncommon for nonhuman primates to vomit when they emerge from anesthesia. Extubation should be delayed until the animal regains the swallowing reflex or other signs of voluntary movement (e.g., head movement and chewing). If vomiting occurs after extubation, the animal should be placed in a prone position with its head lowered to avoid aspiration of the vomitus. Maintaining an arterial catheter until the nonhuman primate regains sufficient consciousness allows one to determine arterial blood gases after the animal is spontaneously breathing room air. To avoid respiratory inadequacy during the postoperative period, we generally do not extubate the nonhuman primate if PaO_2 is less than 60 mmHg and pCO_2 is more than 50 mmHg.

Although we find that *Papio* spp. and macaques initially seem to tolerate mild-to-moderate hypoxemia (PaO_2 55–60 mmHg) relatively well, over a period of time this condition may progress into severe acidosis and circulatory depression.

Before extubation, the oropharynx and trachea are suctioned to clear secretions and blood, which may have accumulated during surgery. Suctioning of the trachea is particularly important for smaller nonhuman primates because respiratory passages can be easily obstructed with bronchial secretions. Attaching a soft rubber catheter to standard suction tubing allows for effective clearing of the trachea and pharynx.

Animals may require careful clinical evaluation for inadequate surgical hemostasis. Sequential hematocrit determinations help provide a rapid and accurate evaluation of a bleeding animal. Animals receiving large amounts of heparin (e.g., during cardiopulmonary bypass) require evaluation of prothrombin time when cardiopulmonary bypass is discontinued. Protamine is usually administered over a period of time to reverse heparin anticoagulation.

Postoperative hypothermia is frequently encountered during a SP. Exposure to a cool ambient temperature in the operating room and the use of unwarmed IV fluids may contribute to significant heat loss. NHPs are particularly at risk of developing severe hypothermia because of their large body surface area, which increases heat loss to the environment. Severe hypothermia may delay awakening by reducing metabolism and excretion of anesthetic drugs. It may also result in hemodynamic compromise manifested in a decrease of cardiac output and bradycardia. Hypothermia should be treated with warming lights, heating blankets, and warm saline bags to raise the body temperature. It is important to prevent burns and avoid placing heating lamps very close to the animal. Space heaters may be used to pre-heat the recovery area. The use of forced-air warming blankets (e.g., Bair Hugger®) is a safe and effective means of providing temperature support in the perioperative period.

Hypotension and tachycardia are common circulatory complications associated with the early postoperative period. Residual effects of anesthetics and inadequately replaced blood loss during surgery are often causes for hypotension. Uncontrolled postoperative bleeding can result in hypovolemia and hypotension. Because bladder catheterization is a relatively simple technique, maintaining a urinary catheter in the early postoperative period helps in evaluating the adequacy of fluid and blood loss replacement.

Hypoglycemia is not uncommon among NHPs (squirrel monkey, owl monkey, common marmoset, and titi monkey). Very palatable foods should be offered as soon as the animal is fully awake. Force-feeding should be avoided, especially in titi monkeys because of their unusual vocal cord structure. This makes force-feeding difficult and can result in aspiration pneumonia (Tardif et al., 2006).

In general, recovery of all nonhuman primates should be accomplished with least possible noise and reduced traffic except essential visual monitoring. Extraneous noise may result

in unnecessary stress especially among marmosets, titi monkeys, and nocturnal monogamous species—*Aotus*. As a consequence of an increase in stressful situations, these animals can develop persistent high blood pressure, which can lead to cardiovascular disease (Tardif et al., 2006).

XI. ANALGESIA

Administration of analgesia to nonhuman primates may be necessitated clinically by events such as trauma related to conspecific interactions in social housing, self-injurious behavior, or injury from activity in the animal's primary enclosure. Analgesia may also be indicated in conjunction with study design that anticipates or produces a painful situation. The use of analgesics should always consider possible side effects and confounding implications on animal care and research goals.

Research primates are wild animals, regardless of their origin. As such they tend to mask signs of discomfort and pain. We may however observe changes in the animal's behavior related to discomfort or pain. Nonhuman primates may show pain by displaying some of the following signs: reduction of appetite (diet or treats), vocalization and gnashing of teeth, change in posture (crouched and huddled), focusing attention on a body part (including biting, scratching, self-mutilating, and licking), avoidance of cage mates, and so on.

The most common analgesic agents employed in research primates include nonsteroidal anti-inflammatory drugs (NSAIDs) and opiate analgesics; the *para*-aminophenol derivative acetaminophen (5–10 mg/kg PO q6h) is also used in the treatment of fever or mild pain, especially in juvenile macaques or new world monkeys (DE). Acetaminophen's rectal formulation (15–20 mg/kg) allows administration to unconscious animals at the end of SP.

Management of pain in animals requires that pain either be anticipated and prevented (preemptive), or be recognized and alleviated (postinductive). Preemptive analgesia presumes that the pain will result from the procedure and that nonpharmacological and pharmacological protocols would be instituted prior to the induction of pain. Preemptive techniques include parenteral administration of systemic analgesics, infiltration of a suture line with local anesthetics, and epidural administration of analgesics. Parenteral analgesia with an opioid or NSAID should be administered prior to making a surgical incision. Postinductive management is used to decrease an animal's experience of a noxious stimuli, and to maintain normal physiological and cardiovascular stability.

The NSAIDs in general reduce fever, and inhibit inflammation and platelet aggregation. These effects are generally related to their ability to inhibit cyclooxygenase in the synthesis of prostaglandins (Vane, 1971). Cyclooxygenase has two distinct isoforms—Cox-1 and Cox-2 (Khan et al., 2002). The Cox-1 isoform is active in many organs and cells and catalyzes PG

synthesis in support of many physiologic functions, including gastric mucosal defense and platelet aggregation. Cox-2 is present in some tissues, and can be turned on by bacterial endotoxins, cytokines, and growth factors, leading to the synthesis of pro-inflammatory PGs. Problematic side effects are usually the result of chronic administration and are rarely seen with short-term administration (Dobromylskyj, P. et al., 2000).

The most common NSAIDs used in nonhuman primates are nonselective Cox inhibitors, meaning that they block both isoforms of cyclooxygenase. These include aspirin, carprofen, ibuprofen, ketoprofen, and ketorolac. Meloxicam is an NSAID produced for veterinary use that has been demonstrated to inhibit Cox-2 to a greater extent than Cox-1 in vitro and in vivo (Boehringer, 2007).

Ibuprofen (7 mg/kg) has been used in both old world and new world nonhuman primates. It should be noted that ibuprofen is a mild analgesic, and as such may only be sufficient for alleviation of mild postsurgical pain. Another NSAID, ketorolac (0.5–1 mg/kg IM in macaques and *Papio* spp.), provides analgesia for moderate postoperative pain in nonhuman primates when parenteral administration is desirable. Because ketorolac may prolong bleeding, it should not be used in nonhuman primates with acquired or natural coagulopathies.

The author prefers the use of carprofen (2–4 mg/kg SC, IV q8h–q12h) administered for mild-to-moderate pain, or as anticipated pre and postsurgically, for 3–4 days. If additional analgesia is required, the opioid buprenorphine (0.01–0.03 mg/kg IM q8h–q12h) may be added for pain management. Flecknell (2005) reports the use of carprofen (3–4 mg/kg IV, SC) administered preoperatively in rhesus macaques, followed by meloxicam daily oral dosing [0.1–0.2 mg/kg Metacam palatable drops (Boehringer) starting 1 day postsurgery, and continued daily for up to 3 days]. During his clinical observation of 24 surgeries, wound swelling was noted to be substantially reduced, and there were no clinical signs of delayed bone healing related to cranial implants.

Mu-specific opioid (morphine 1–2 mg/kg IM or SQ every 4 hours) is generally indicated for the treatment of moderate-to-severe postoperative pain. Alternatively, Popilskis used a continuous infusion of morphine 0.5 mg/h/day for 48 hours to provide adequate analgesia after laparotomy in pregnant baboons (Popilskis et al., 1994).

Although morphine produces reliable postoperative analgesia, it causes dose-dependent reduction in respiratory rate and pO₂ and increases in pCO₂ (Dourish et al., 1990). It should be used with care, especially in NWP. In general, chronic administration of opioids may result in physical dependence and/or tolerance. For this reason, all of the opioids used clinically are controlled substances.

Oxymorphone, 0.15 mg/kg (Old World Primates) and 0.075 mg/kg (NWP) IM, every 4–6 hours, is an effective analgesic without producing noticeable respiratory depression in both old and new world monkeys (Rosenberg, 1991). In humans,

this opioid has an oral 12-hour sustained release form that offers further investigation for its use in nonhuman primates (Barash et al., 2006).

Opioid agonist-antagonists (buprenorphine and butorphanol) have been used to provide postoperative analgesia in nonhuman primates. Buprenorphine (0.01 mg/kg IM, IV) is the most commonly used injectable analgesic in nonhuman primates (Flecknell, 1987). The long duration of effect (6–8 hours) and relative absence of respiratory depression make buprenorphine an attractive alternative to other analgesia regimens. Tame et al. (1999) administered continuous infusion of buprenorphine to a pregnant baboons at 30 µg/kg/day for 48 hours through intra-arterial catheter protected by the tether system. This dose of buprenorphine resulted in inhibition of postoperative myometrial contractions as well as lower maternal estradiol and cortisol concentrations.

Buprenorphine, 0.015 mg/kg, provides effective analgesia for mild-to-moderate pain in *S. sciureus* (Morris, personal communication, 1995). Brady (personal communication, 2007) administers buprenorphine 0.01 mg/kg IM to squirrel and owl monkeys preemptively in cases where pain may be anticipated during recovery from anesthesia. In *Galago* spp., buprenorphine, at a dosage of 0.01 mg/kg, IM or SQ, provides satisfactory postoperative analgesia for up to 12 hours without excessive sedation (McTighe, personal communication, 2008)

Butorphanol (0.003–0.32 mg/kg) is also indicated for treatment of moderate pain. It is associated with mild sedation that may be useful in avoiding problems associated with delirium in the immediate postoperative period. In laboratory setting, butorphanol (0.003–0.1 mg/kg) produces mild to moderate analgesia, devoid of substantial sedative or muscle relaxant effects in rhesus monkeys (Butelman et al., 1995). The lack of pronounced sedation can be attributed to the lower dose of butorphanol. However, even at this dose range, respiratory depression was noticeable. Butorphanol (0.02 mg/kg SQ) has also been used for postoperative analgesia in new world species (*Saguinus* spp. and *C. geoffroyi*) (Wolff et al., 1990). For postoperative pain in chimpanzees, butorphanol is given IM postoperatively once the animal is able to move. Chimpanzees are very sensitive to drugs that cause respiratory depression; therefore, it is recommended that a dose of 0.02 mg/kg be given IM, not to exceed 0.3 mg total (1 vial).

In case of potential overdose with opiate analgesics, naloxone can be of invaluable assistance. When administered intravenously it effectively reverses respiratory depression induced by opioids. The usual dose of naloxone is 0.1–0.2 mg IV, repeated as needed. Naloxone is a short-acting antagonist and a second dose may be necessary to avoid the return of respiratory depression. This may be of importance in trying to antagonize respiratory depression caused by administration of long-lasting buprenorphine.

Coadministration of opioids with NSAID's takes advantage of desirable properties of each drug. The desired result of these combinations is achievement of effective and reliable analgesia

at lower doses of each of the drugs. Another advantage of this combination is the concomitant decrease in the incidence and severity of side effects. The author (SP) has administered ketorolac (0.5–1 mg/kg IM) in addition to buprenorphine (0.01 IM, q8h–q12h) for mild-to-moderate pain in rhesus monkeys and baboons. The preferred method for mild-to-moderate pain management in chimpanzee is oral acetaminophen with codeine (0.24–0.36 mg/kg) every 6 hours. In addition, a variety of oral NSAIDs are well tolerated by the chimpanzees (Lee and Guhad, 2001).

Postoperative IM administration of opioids results in variable absorption, especially in hypotensive and hypothermic animals, and this may reflect a considerable delay between administration of the drug and effective analgesia. Continuous IV infusion of opioids may be more effective, but it is impractical in uncooperative nonhuman primates. It also may carry a greater risk of respiratory depression, sedation, and hypotension, thus requiring close monitoring.

The discovery of opioid receptors in the spinal cord has led to great interest in the use of these drugs by the epidural route. The action of epidural opioids is mediated by receptors located in the substantia gelatinosa in the dorsal horn of the spinal cord. Previous studies have suggested that administration of epidural opioids produce effective and safe postoperative analgesia with minimal sympathetic blockade, and no sedation or respiratory depression (Morgan, 1989; Rutberg et al., 1984; Shulman et al., 1987). Placement of an epidural catheter is a relatively simple technique in nonhuman primates such as macaques and *Papio* spp. We introduce an 18-gauge Tuohy epidural needle with a curved distal end at lumbar 5–6 or 6–7 interspace. Once the epidural needle penetrates the intraspinal ligament, the characteristic “pop” sound is heard. A glass syringe with a freely movable plunger is attached and the needle is advanced into the epidural space. Entry into the epidural space is confirmed by ease of depression of the plunger in the syringe. The nylon catheter is then inserted and the epidural needle is removed. The catheter is usually advanced 5–7 cm from the introduction site to ascertain the proper placement.

Morphine is one of the most commonly used opiate analgesics via the epidural route. One of the main advantages of epidural morphine is that it has low lipid solubility relative to other opioids, which makes systemic absorption less likely to occur from the epidural site. This suggests that more of the drug is available at the receptor sites in the spinal cord, resulting in prolonged analgesia. We have used epidural morphine (single injection of 0.1 mg/kg) for pain relief after thoracotomy and hysterotomy in baboons, with postoperative analgesia lasting up to 24 hours. Morphine, 0.01 mg/kg given intrathecally as a single dose, has been reported to provide excellent postoperative analgesia for 18–24 hours in *P. troglodytes* with no concomitant clinically recognizable hypotension. Alternatively, an epidural catheter can be inserted closer to the incision site and 2–3 ml of a diluted (0.125%) bupivacaine administered in combination with morphine 0.075 mg/kg.

REFERENCES

- Adams, S.R., Muchmore, E., and Richardson, J.H. (1995). Biosafety, Part C. Model occupational health program for persons working with nonhuman primates. In "Nonhuman Primates in Biomedical Research: Biology and Management." (B.T. Bennett et al., eds.), pp 412–414. Academic Press, San Diego, CA.
- Antognini, J.F., Barter, L., and Carstens, E. (2005). Movement as an index of anesthetic depth in humans and experimental animals. *Comp. Med.* **55**(5), 413–418.
- April, M., Tabor, E., and Gerety, R.J. (1982). Combination of ketamine and xylazine for effective anesthesia of juvenile chimpanzees (*Pan troglodytes*). *Lab. Anim.* **16**, 116–117.
- Authier, S., Chaurand, F., Legaspi, M., et al. (2006). Comparison of three anesthetic protocols for intraduodenal drug administration using endoscopy in rhesus monkeys. *JAALAS* **45**(6), 73–79.
- Banknieder, A.R., Phillips, J.M., Jackson, K.T., and Vinal, S.I., Jr. (1978). Comparison of ketamine with the combination of ketamine and xylazine for effective anesthesia in the rhesus monkey (*Macaca mulatta*). *Lab. Anim. Sci.* **28**, 742–745.
- Barnstein, N.J., Gilfillan, R.S., Pace, N., and Rahlman, D.E. (1966). Chronic intravascular catheterization. A technique for implanting and maintaining arterial and venous catheters in laboratory primates. *J. Surg. Res.* **12**, 511–521.
- Bennett, J.S., Gossett, K.A., McCarthy, M.P., and Simpson, E.D. (1992). Effects of ketamine hydrochloride on serum biochemical and hematologic variables in rhesus monkeys (*Macaca mulatta*). *Vet. Clin. Pathol.* **21**, 15–18.
- Bennett, S.N., McNeil, M.M., Bland, L.A., Arduino, M.J., Villarino, M.E., Perrotta, D.M., Burwen, D.R., Welbel, S.F., Pegues, D.A., Stroud, L., Zeitz, P.S., and Jarvis, W.R. (1995). Postoperative infections traced to contamination of an intravenous anesthetic, propofol. *N. Engl. J. Med.* **333**, 147–154.
- Benson, G.J. (2000). Anesthesia and analgesia: Physiologic effects of pharmacologic agents, veterinary clinical services, Yale Animal Resources Center. Online: <http://info.med.yale.edu/yarc/vcs/anesthesiaeffect.htm>
- Bentson, K.L., Capitano, J.P., and Mendoza, S.P. (2003). Cortisol responses to immobilization with Telazol or ketamine in baboons (*Papio cynocephalus/anubis*) and rhesus macaques (*Macaca mulatta*). *J. Med. Primatol.* **32**(3), 148–160.
- Beveniste, H., Fowler, J.S., Rooney, W.D., Moller, D.H., Backus, W.W., Warner, D.A., Carter, P., King, P., Scharf, B., Alexoff, D.A., Ma, Y., Vaska, P., Schlyer, D., Volkow, N.D., PET Study, MRI Study. (2003). Maternal-fetal in vivo imaging: A combined PET and MRI study. *J. Nucl. Med.* **44**(9), 1522–1530.
- Boehringer, I. (2007). Animal Health & Veterinary Pharmaceuticals. Online: http://www.boehringer-ingelheim.com/corportate/products/animal_health_catdog_01.htm
- Bohm, R.P. Jr, Rockar, R.A., Ratterree, M.S., Blanchard, J.L., Harouse, J., Gettie, A., Cheng-Mayer, C. (2000). A method of video-assisted thorascopic surgery for collection of thymic biopsies in rhesus monkeys (*Macaca mulatta*). *Cont. Top. Lab. Anim. Sci.* **39**(6), 24–26.
- Booker, J.L., Erickson, H.H., and Fitzpatrick, E.L. (1982). Cardiodynamics in the rhesus macaque during dissociative anesthesia. *Am. J. Vet. Res.* **43**, 671–676.
- Brady, A.G., and Koritnik, D.R. (1985). The effects of ketamine anesthesia on glucose clearance in African Green Monkeys. *J. Med. Primatol.* **14**, 99–107.
- Branston, N.M., Hope, D.T., and Symon, L. (1979). Barbiturates in focal ischemia of primate cortex effects on blood flow distribution, evoked potentials and extracellular potassium. *Stroke* **10**, 647–653.
- Butelman, E.R., Winger, G., Zernig, G., and Woods, J.H. (1995). Butorphanol: Characterization of agonist and antagonist effects in rhesus monkeys. *J. Pharmacol. Exp. Ther.* **272**(2), 845–853.
- Castro, M.I., Rose, J., Green, W., Lehner, N., Peterson, D., and Taub, D. (1981). Ketamine-HCl as a suitable anesthetic for endocrine, metabolic, and cardiovascular studies in *Macaca fascicularis* monkeys. *Proc. Soc. Exp. Biol. Med.* **168**, 389–394.
- Cohen, B.J., and Bree, M.M. (1978). Chemical and physical restraint of nonhuman primates. *J. Med. Primatol.* **7**, 193–201.
- Cook, R.A., and Clarke, D.A. (1985). The use of isoflurane as a general anesthetic in the western lowland gorilla (*Gorilla gorilla*). *J. Zoo Anim. Med.* **16**, 122–124.
- DaRif, C.A., and Rush, H.G. (1983). Management of septicemia in rhesus monkeys with chronic indwelling venous catheters. *Lab. Anim. Sci.* **33**, 90–94.
- Davy, C.W., Trennery, P.N., Edmunds, J.G., Altman, J.F.B., and Eichler, D.A. (1987). Local myotoxicity of ketamine hydrochloride in the marmoset. *Lab. Anim.* **21**, 60–67.
- Dhiri, A.K. (1985). Continuous intravenous infusion using Saffan (CT 1341) in the *Erythrocebus patas*. *Lab. Anim.* **19**, 159.
- Doane, C.J., Lee, D.R., and Sleeper, M.M. (2006). Electrocardiogram abnormalities in captive chimpanzees (*Pan troglodytes*). *Comp. Med.* **55**(6), 486–491.
- Dobromylskij, P., Flecknell, P.A., Lascelles, B.D., Pascoe, P.J., Taylor, P., Waterman-Pearson, A. (2000). Management of postoperative and other acute pain. In "Pain Management in Animals." (P.A. Flecknell, A. Waterman-Pearson, eds.), pp 81–145. Saunders, Edinburgh.
- Dormehl, I.C., Jacobs, D.J., duPlessis, M., and Goosen, D.J. (1984). Standardization of anesthesia for radiorenography with primates under laboratory conditions. *J. Med. Primatol.* **13**, 5–10.
- Dourish, C.T., O'Neill, M.F., Schaffer, L.W., Siegl, P.K.S., and Iversen, S.D. (1990). The cholecystokinin receptor antagonist devazepide enhances morphine-induced respiratory depression in the squirrel monkey. *J. Pharmacol. Exp. Ther.* **255**, 1158–1165.
- Ebert, T.J. in Barash, P.G., Cullen, B.F. and Stoelting, R.K. (2005). "Clinical Anesthesia," 5th ed., p 396. Lippincott Williams and Williams. Philadelphia, PA.
- Eng, M., Bonica, J.J., Alamtsu, T.J., Berges, P.U., Yuen, D., and Ueland, K. (1975). Maternal and fetal responses to halothane in pregnant monkeys. *Acta Anaesthesiol. Scand.* **19**, 154–158.
- Enlund, M., Andersson, J., Hartvig, P., Valtysson, J., and Wiklund, L. (1997). Cerebral normoxia in the rhesus monkey during isoflurane- or propofol-induced hypotension and hypocapnia, despite disparate blood-flow patterns. A positron emission tomography study. *Acta Anaesthesiol. Scand.* **41**(8), 1002–1010.
- Fanton, J.W., Zarr, S.R., Ewert, D.L., Woods, R.W., and Koenig, S.C. (2000). Cardiovascular responses to propofol and etomidate in long-term instrumented rhesus monkeys (*Macaca mulatta*). *Comp. Med.* **50**(3), 303–308.
- Ferris, C.F., Snowdon, C.T., King, J.A., Sullivan, J.M., Ziegler, T.E., Olson, D.P., Schultz-Darken, N.J., Tannenbaum, P.L., Ludwig, R., Wu, Z., Einspanier, A., Vaughan, J.T., and Duong, T.Q. (2004). Activation of neural pathways associated with sexual arousal in non-human primates. *J. Magn. Reson. Imaging* **19**, 168–175.
- Flecknell, P.A. (1987). "Laboratory Animal Anesthesia," p 128. Academic Press, London.
- Flecknell, P. (2005). Clinical experience with NSAIDs in Macaques. *Lab. Primate Newsl.* **44**(1), 4.
- Fleming, S.A., and Bearchroft, W.G.C. (1966). The effect of repeated administration of halothane on the livers of healthy monkeys. *Can. Anaesth. Soc. J.* **13**, 247–250.
- Fortman, J.D., Hewett, T.A., and Bennett, B.T. (2002). "The Laboratory Non-human Primate," pp 128–131. CRC Press, Boca Raton, FL [Comment DE4].
- Fowler, K.A., Huerkamp, M.J., Pullium, J.K., and Subramanian, T. (2001). Anesthetic protocol: Propofol use in rhesus macaques (*Macaca mulatta*) during magnetic resonance imaging with stereotactic head frame application. *Brain Res. Brain Res. Protoc.* **7**(2), 87–93.
- Fowler, M.E. (1986). Restraint. In "Zoo and Wild Animal Medicine." (M.E. Fowler, ed.), 2nd ed., Chap. 6, pp 44–47. Saunders, Philadelphia, PA.

- France, C.P., and Weltman, R.H. (2006). Acute and chronic effects of ramelteon in rhesus monkeys (*Macaca mulatta*): Dependence liability studies. *Behav. Neurosci.* **120**(3), 535–541.
- Gaglio, P.J., Baskin, G., Bohm, R., Blanchard, J., Cheng, S., Dunne, B., Davidson, J., Liu, H., and Dash, S. (2000). Partial hepatectomy and laparoscopic-guided liver biopsy in rhesus macaques (*Macaca mulatta*): Novel approach for study of liver regeneration. *Comp. Med.* **50**(4), 363–368.
- Goosen, D.J., Davies, J.H., Maree, M., and Dormehl, I.C. (1984). The influence of physical and chemical restraint on the physiology of the chacma baboon (*Papio ursinus*). *J. Med. Primatol.* **13**, 339–351.
- Green, C.J., Knight, J., Precious, S. and Simpkins, S. (1981). Ketamine alone or combined with diazepam or xylazine in laboratory animals: A 10 year experience. *Lab. Anim.* **15**, 163–170.
- Hayama, S., Terazawa, F., Suzuk, M., et al. (2006). Immobilization with a single dose of ketamine hydrochloride and a combination of xylazine hydrochloride-ketamine hydrochloride, and antagonism by yohimbine hydrochloride in the Japanese monkey (*Macaca fuscata*). *Primates* **30**(1), 75–79.
- Hill, L.R., Lee, D.R., and Keeling, M.E. (2001). A surgical technique for ambulatory management of airsacculitis in a chimpanzee (*Pan troglodytes*). *Comp. Med.* **51**(1), 80–84.
- Hom, G.J., Bach, T.J., Carroll, D., Forrest, M.J., Mariano, M.A., Trainor, C.E., Wang, P.R., and MacIntyre, D.E. (1999). Comparison of cardiovascular parameters and/or serum chemistry and hematology profiles in conscious and anesthetized rhesus monkeys (*Macaca mulatta*). *Contemp. Top.* **38**(2), 60–64.
- Iyer, R.A., and Anders, M.W. (1996). Cysteine conjugate beta-lyase-dependent biotransformation of the cysteine S-conjugates of the sevoflurane degradation product compound A in human, nonhuman primate, and rat kidney cytosol and mitochondria. *Anesthesiology* **85**(6), 1454–1461.
- Jacobs, B., Harris, G.C., Allada, V., Chugani, H.T., Pollack, D.B., and Raleigh, M.J. (1993). Midazolam as an effective intravenous adjuvant to prolonged ketamine sedation in young rhesus (*Macaca mulatta*) and vervet (*Cercopithecus aethiops sabacus*) monkeys: A preliminary report. *Am. J. Primatol.* **29**, 291–298.
- Jalanka, H.H., and Roeken, B.O. (1990). The use of medetomidine, medetomidine-ketamine combinations, and atipamezole in nondomestic mammals: A review. *J. Zoo Wildl. Med.* **21**, 259–282.
- Johnson, E.N., Hawken, M.J., and Shapley, R. (2004). Cone inputs in macaque primary visual cortex. *J. Neurophysiol.* **91**(6), 2501–2514.
- Kalema-Zikusoka, G., Horne, W.A., Levine, J., and Loomis, M.R. (2003). Comparison of the cardiorespiratory effects of medetomidine–butorphanol–ketamine and medetomidine–butorphanol–midazolam in Patas monkeys (*Erythrocebus patas*). *J. Zoo Wildl. Med.* **34**(1), 47–52.
- Kaneko, T., Ochiai, R., Yoshikawa, T., Takeda, J., Fukushima, K., Tsukada, H., Okada, H., Seki, C., and Kakiuchi, T. (1997). The effect of cerebral perfusion pressure on cerebral blood flow in the rhesus monkey during sevoflurane anesthesia. *Masui* **46**(2), 166–172.
- Kaufman, P.L., and Hahnenberger, R. (1975). CI-744 anesthesia for ophthalmological examination and surgery in monkeys. *Invest. Ophthalmol.* **14**, 788–791.
- Khan, K.M.N., Paulson, S.K., Verburg, K.M., Lefkowitz, J.B., and Maziasz, T.J. (2002). Pharmacology of cyclooxygenase-2 inhibition in the kidney. *Kidney Int.* **61**, 1210–1219.
- Kim, C.Y., Lee, H.S., Han, S.C., Heo, J.D., Kwon, M.S., Ha, C.S., and Han, S.S. (2005). Hematological and serum biochemical values in cynomolgus monkeys anesthetized with ketamine hydrochloride. *J. Med. Primatol.* **34**, 96–100.
- Klein, H.J., and Murray, K.A. (1995). Medical management. Part C. Restraint. In “Nonhuman Primates in Biomedical Research: Biology and Management.” (B.T. Bennett, C.R. Abee, and R. Henrickson, eds.), pp 287–297. Academic Press, San Diego, CA.
- Ko, J. (2006). Pharmacology: Intravenous Agents and Dissociatives—Lecture 6, Oklahoma State University—Center for Veterinary Health Science. Online: www.cvm.okstate.edu/Courses/vmed5412/LECT006.htm
- Ko, M.C., Terner, J., Hursh, S., Woods, J.H., and Winger, G. (2002). Relative reinforcing effects of three opioids with different durations of action. *J. Pharmacol. Exp. Ther.* **301**(2), 698–704.
- Lee, D.R., and Fleming, T.E. (1993). Evaluation of tiletamine–zolazepam (Telazol®)0. as an anesthetic agent for chimpanzees. *Contemp. Top.* **32**(4), 25–26.
- Lee, D.R., and Guhad, F.A. (2001). Medical management of captive chimpanzees. In “The Care and Management of Captive Chimpanzees.” American Society of Primatologist, Vol. 2: Special Topics in Primatology. Wiley-Liss. San Antonio, TX
- Lee, D.R., Kuehl, T.J., and Eichberg, J.W. (1991). Real-time ultrasonography as a clinical and management tool to monitor pregnancy in a chimpanzee breeding colony. *Am. J. Primatol.* **24**(3, 4), 289–294.
- Lee, J.I., Hong, S.H., Lee, S.J., Kim, Y., and Kim, M.C. (2003). Immobilization with ketamine HCl and tiletamine–zolazepam in cynomolgus monkeys. *J. Vet. Sci.* **4**(2), 187–191.
- Levinson, G., Shnider, S.M., deLorimier, A.A., and Steffenson, J.L. (1974). Effects of maternal ventilation on uterine blood flow and fetal oxygenation and acid-base status. *Anesthesiology* **40**, 340–347.
- Lewis, J.C.M. (1993). Medetomidine–ketamine anesthesia in the chimpanzee (*Pan troglodytes*). *J. Vet. Anaesthesiol.* **20**, 18–20.
- Liao, P., Bodkin, N., Cho, E., Alexander, T., and Ortmeyer, H. (2004). Minimally invasive surgery via laparoscopy for intra-abdominal biopsy in obese rhesus macaques (*Macaca mulatta*). *Comp. Med.* **54**(2), 159–164.
- Loeb, W.F., Cicmonec, J.L., and Wickum, M. (1976). A coagulopathy of the owl monkey (*Aotus trivirgatus*) associated with high antithrombin III activity. *Lab. Anim. Sci.* **26**, 1084–1086.
- Logdberg, B. (1988). Alphaxalone–alphadolone for anesthesia in squirrel monkeys of different ages. *J. Med. Primatol.* **17**, 163–167.
- Loomis, M.R., Henrickson, R.V., and Anderson, J.H. (1980). Effects of ketamine hydrochloride on the hemogram of rhesus monkeys (*Macaca mulatta*). *Lab. Anim. Sci.* **30**, 851–853.
- Lopez, K.R., Gibbs, P.H., Reed, D.S. (2002). A comparison of body temperature changes due to the administration of ketamine-acepromazine and tiletamine-zolazepam anesthetics in cynomolgus macaques. *Cont. Topics Lab. Anim. Sci.* **41**(2), 47–50.
- McCully, C.L., Balis, F.M., Bacher, J., Phillips, J., and Poplack, D.G. (1990). A rhesus monkey model for continuous infusion of drugs into cerebrospinal fluid. *Lab. Anim. Sci.* **40**, 520–525.
- Morgan, M. (1989). The rational use of intrathecal and extradural opioids. *Br. J. Anaesthesiol.* **63**, 165–188.
- Morgan, M.A., Silavin, S.L., Wentworth, R.A., Figueroa, J.P., Honnebie, B.O.M., Fishburne, J.I. Jr, Nathanielsz, P.W. (1992). Different patterns of myometrial activity and 24-H rhythms in myometrial contractility in the gravid baboon during the second half of pregnancy. *Biol. Reprod.* **46**(6), 1158–1164.
- Morita, H., Nemoto, E.M., Bleyaert, A.L., and Stezoski, S.W. (1977). Brain blood flow autoregulation and metabolism during halothane anesthesia in monkeys. *Am. J. Physiol.* **233**, H670–H676.
- Morris, T.H., Jackson, R.K., Acker, W.R., Spencer, C.K., and Drag, M.D. (1997). An illustrated guide to endotracheal intubation in small non-human primates. *Lab. Anim.* **31**, 157–162.
- Naccarato, E.F., and Hunter, W.S. (1979). Anesthetic effects of various ratios of ketamine and xylazine in rhesus monkeys (*Macaca mulatta*). *Lab. Anim.* **13**, 317–319.
- National Research Council (NRC). (1996). “Occupational Health and Safety in the Care and Use of Research Animals.” A report of the Institute of Laboratory Animal Resources Committee on Occupational Safety and Health of Personnel in Research Animal Facilities. National Academy Press, Washington, D.C.
- National Research Council (NRC). (2003). “Occupational Health and Safety in the Care and Use of Nonhuman Primates”, Report of the ILAR Committee on Occupational Health and Safety in the Care and Use of Nonhuman Primates, National Academies Press, Washington, D.C. [Comment DE3].

- Nehls, D.G., Cartwright, M., and Spetzler, R.F. (1986). Experimental primate stroke model. *Neurosurgery* **18**(3), 388–389.
- Nehls, D.G., Todd, M.M., Spetzler, R.F., Drummond, J.C., Thompson, R.A., and Johnson, P.C. (1987). A comparison of the cerebral protective effects of isoflurane and barbiturates during temporary focal ischemia in primates. *Anesthesiology* **66**(4), 453–464.
- Nussmeier, N.A., Benthuyens, J.L., Steffey, E.P., Anderson, J.H., Carstens, E.E., Eisele, J.H., Jr., and Stanley, T.H. (1991). Cardiovascular, respiratory and analgesic effects of fentanyl in unanesthetized rhesus monkeys. *Anesth. Analg.* **72**, 221–226.
- Ouchi, T., Ochiai, R., Takeda, J., Tsukada, H., and Kakiuchi T. (2006). Combined effects of propofol and mild hypothermia on cerebral metabolism and blood flow in rhesus monkey: A positron emission tomography study. *J. Anesth.* **20**(3), 208–214.
- Perret-Gentil, M.I., Sinanan, N.M., Dennis, M.B., Anderson, D.M., Pasieka, H.B., Weyhrich, J.T., Birkebak, T.A. (2000). Videoendoscopic techniques for collection of multiple, serial intra-abdominal biopsy specimens in HIV-negative and HIV-positive pigtail macaques (*Macaca nemestrina*). *J. Invest. Surg.* **13**(4), 181–195.
- Phillips, I.R., and Grist, S.M. (1975). Clinical use of C 1341 anesthetic ('Saffan') in marmosets (*Callithrix jacchus*). *Lab. Anim.* **9**, 57–60.
- Popilskis, S., Danilo, P., Acosta, H., and Kohn, D. (1992). Is preoperative fasting necessary? *J. Med. Primatol.* **21**, 349–352.
- Popilskis, S., Daniel, S., and Smiley, R. (1994). Effects of epidural versus intravenous morphine analgesia on postoperative catecholamine response in baboons. Proceedings of International Congress Veterinary Anesthesia 5th, Guelph, Canada, Aug. 21–25.
- Pulley, A.C.S., Roberts, J.A., and Lerche, N.W. (2004). *J. Zoo Wildl. Med.* **35**(4), 497–502 [Comment DE5].
- Rawlings, C.A., Van Lue, S., King, C., Freeman, L., Damian, R.T., et al. (2000). Serial laparoscopic biopsies of liver and spleen from *Schistosoma*-infected baboons (*Papio* spp). *Comp. Med.* **50**, 551–555.
- Reutlinger, R.A., Karl, A.A., Vinal, S.L., and Nieser, M.J. (1980). Effects of ketamine HCl-xylazine HCl combination on cardiovascular and pulmonary values of the rhesus macaque (*Macaca mulatta*). *Am. J. Res.* **41**, 1453–1457.
- Ritzman, J.R., Erickson, H.H., Miller, E.D. Jr. (1976). Cardiovascular effects of enflurane and halothane on the rhesus monkey. *Anesthesia and Analgesia – Current Researches* **55**, 85–91.
- Rosenberg, D.P. (1991). Nonhuman primate analgesia. *Lab. Anim.* **20**, 22–32.
- Rutberg, H., Hakanson, E., Anderberg, B., Jorfeldt, L., Martensson, J., and Schildt, B. (1984). Effects of the extradural administration of morphine or bupivacaine, on the endocrine response to upper abdominal surgery. *Br. J. Anaesthesiol.* **56**, 233–238.
- Sainsbury, A.W., Eaton, B.D., and Cooper, J.E. (1989). Restraint and anesthesia of primates. *Vet. Rec.* **125**, 640–643.
- Sainsbury, A.W., Eaton, B.D., and Cooper, J.E. (1991). An investigation into the use of propofol (Rapinovel) in long-tailed macaques (*Macaca fascicularis*). *J. Vet. Anaesthesiol.* **18**, 38–41.
- Sanders, E.A., Gleed, R.D., and Nathanielsz, P.W. (1991). Anesthetic management for instrumentation of the pregnant rhesus monkey. *J. Med. Primatol.* **20**, 223–228.
- Sato, M., Hamada, Y., Tkada, K., Tanano, A., Tokuhara, K., and Hatano, T. (2005). Thoracoscopic diaphragmatic procedures under artificial pneumothorax. *Pediatr. Surg. Int.* **21**(1), 34–38.
- Scalese, R.J., DeForrest, J.M., Hammerstone, S., Parente, E., and Burkett, D.E. (1990). Long term vascular catheterization of the cynomolgus monkey. *Lab. Anim. Sci.* **40**, 530–532.
- Schmutzler, R., van Uem, J.F.H.M., Elkind-Hirsch, K., Hahn, D., McGuire, J.L., Danforth, D.R., and Hodgen, G.D. (1988). Subcutaneous implantable infusion device for chronic intravenous pulsatile gonadotropin-releasing hormone treatment. *J. Med. Primatol.* **17**, 281–285.
- Schreiner, M., Triebwasser, A., and Keon, T. (1990). Ingestion of liquids compared with preoperative fasting in pediatric outpatients. *Anesthesiology* **72**, 593–597.
- Sedgwick, C.J. (1986). Scaling and anesthesia for primates. In "Primates: The Road to Self-Sustaining Populations." (K. Benirschke, ed.), pp 815–823, Springer-Verlag, New York.
- Shulman, E.R., McIver, F.T., Burkes, E.J. Jr. (1987). Comparison of electro-surgery and formocresol as pulpotomy techniques in monkey primary teeth. *Pediatr. Dent.* **9**(3), 189–194.
- Socha, W.W., Moor-Jankowski, J., and Ruffie, J. (1984). Blood groups of primates: Present status, theoretical implications and practical applications: A review. *J. Med. Primatol.* **13**, 11–40.
- Socha, W.W., Rowe, A.W., Lenny, L.L., Lasano, S.G., and Moor-Jankowski, J. (1982). Transfusion of incompatible blood in rhesus monkeys and baboons. *Lab. Anim. Sci.* **32**, 48–56.
- Sofianos, E., Alevizou, F., Zissis, N., Kostaki, P., and Balamoutsos, N. (1985). Effects of high-dose fentanyl anesthesia, compared to halothane anesthesia. *Acta Anaesthesiol. Belg.* **36**, 89–96.
- Soma, L.R., Tierney, W.J., Hogan, G.K., and Satoh, N. (1995). The effects of multiple administrations of sevoflurane to cynomolgus monkeys: Clinical pathologic, hematologic, and pathologic study. *Anesth. Analg.* **81**(2), 347–352.
- Soma, L.R., Tierney, W.J., and Satoh, N. (1988). Sevoflurane anesthesia in the monkey: The effects of multiples of MAC. Hiroshima. *J. Anesth.* **24**, 3–14.
- Somogyi, A., and Gugler, R. (1982). Drug interactions with cimetidine. *Clin. Pharmacokinet.* **7**, 23.
- Southers, J.L., and Ford, E.W. (1995). Medical management. Part A. Preventive medicine. In "Nonhuman Primates in Biomedical Research. Biology and Management." (B.T. Bennett et al., eds.), pp 257–270. Academic Press, San Diego, CA.
- Steffey, E.P., Gillespie, J.R., Berry, J.D., Eger, E.I. II, and Munson, E.S. (1974a). Anesthetic potency (MAC) of nitrous oxide in the dog, cat, and stump-tail monkey. *J. Appl. Physiol.* **36**, 530–532.
- Steffey, E.P., Gillespie, J.R., Berry, J.D., Eger, E.I. II, and Rhode, E.A. (1974b). Cardiovascular effects of halothane in the stump-tailed macaque during spontaneous and controlled ventilation. *Am. J. Vet. Res.* **35**, 1315–1320.
- Stoelting, R.K., and Miller, R.D. (1994a). In "Basics of Anesthesia." (R. Stoelting and R. Miller, eds.), Vol. 3, p 60. Churchill-Livingstone, New York.
- Stoelting, R.K., and Miller, R.D. (1994b). In "Basics of Anesthesia." (R. Stoelting and R. Miller, eds.), Vol. 3, p 360. Churchill-Livingstone, New York.
- Sun, F.J., Wright, D.E., and Pinson, D.M. (2003). Comparison of ketamine versus combination of ketamine and medetomidine in injectable anesthetic protocols: Chemical immobilization in macaques and tissue reaction in rats. *Contemp. Top. Lab. Anim. Sci.* **42**(4), 32–37.
- Tame, J., Abrams, L., Ding, X.Y., Yen, A., Giussani, D., and Nathanielsz, P. (1999). Level of postoperative analgesia is a critical factor in regulation of myometrial contractility in the pregnant baboon: implications for human fetal surgery. *Am. J. Obstet. Gynecol.* **80**(5), 1196–1201.
- Tardif, S., Bales, K., Williams, L., Moeller, E.L., Abbott, D., Schultz-Darken, N., Mendoza, S., Mason, W., Bourgeois, S., and Ruiz, J. (2006). Preparing new world monkeys for laboratory research. *ILAR J.* **47**(4), 307–315.
- Taylor, N.F., Martin, M.C., Nathanielsz, P.W., Seron-Ferre, M. (1983). The fetus determines circadian oscillation of myometrial electromyographic activity in the pregnant rhesus monkey. *Am. J. Obstet. Gynecol.* **146**(5), 557–567.
- Tinker, J.H., Sharbrough, F.W., and Michenfelder, J.D. (1977). Anterior shift of the dominant EEG rhythm during anesthesia in the java monkey: Correlation with anesthetic potency. *Anesthesiology* **46**, 252–259.
- Tsai, S.K., and Lee, C. (1989). Ketamine potentiates nondepolarizing neuromuscular relaxants in a primate. *Anesth. Analg.* **68**, 5–8.
- Tsai, S.K., Lee, C., and Tran, B. (1989). Ketamine enhances phase I and phase II neuromuscular block of succinylcholine. *Can. J. Anaesth.* **36**, 120–123.
- Udelman, R., Bacher, J., Gallucci, W.T., Gold, P.W., Morin, M.L., Renquist, D., Lorieux, D.L., and Chrousos, G.P. (1984). Hemodynamic and endocrine parameters in the anesthetized cynomolgus monkey: A primate model. *J. Med. Primatol.* **13**, 327–338.

- Vane, J.R. (1971). Inhibition of prostaglandin synthesis as a mechanism of action for aspirin-like drugs. *Nat. New Biol.* **231**, 232–235.
- Valverde, C.R., Mama, K.R., Kollias-Baker, C., Steffey, E.P., and Baggot, J.D. (2000). Pharmacokinetics and cardiopulmonary effects of fentanyl in isoflurane-anesthetized rhesus monkeys (*Macaca mulatta*). *Am. J. Vet. Res.* **61**(8), 931–934.
- Venkatesan, R., Nagarajam, P., Rajaretnam, R.S., and Majumdar, S.S. (2006). Hematological and serum biochemical values in aged female bonnet macaques (*Macaca radiata*) anesthetized with ketamine hydrochloride. *JAALAS* **45**(2), 45–48.
- Villemagne, V., Yuan, J., Wong, D.F., Dannals, R.F., Hatzidimitriou, G., Mathews, W.B., Ravert, H.T., Musachio, J., McCann, U.D., Ricaurte, G.A. (1998). Brain dopamine neurotoxicity in baboons treated with doses of methamphetamine comparable to those recreationally abused by humans: Evidence from [¹¹C]WIN-35,428 positron emission tomography studies and direct in vitro determinations. *J. Neurosci.* **18**(1), 419–427.
- Wake Forest University School of Medicine, Animal Resources Program, Drug Formulary for Laboratory Animals, Non-Human Primates. (2006). Online: www1.wfubmc.edu/ARP/health
- Wallis, J., and Lee, D.R. (1999). Primate conservation: The prevention of disease transmission. *Int. J. Prim.* **20**(6), 803–826.
- Whelan, G., James, M.F., Samson, N.A., and Wood, N.I. (1999). Anaesthesia of the common marmoset (*Callithrix jacchus*) using continuous intravenous infusion of alphaxalone/alphadalone. *Lab. Anim.* **33**(1), 24–29.
- Wolff, P.L., Pond, J., and Meehan, T. (1990). Surgical removal of *Prosthenorchis elegans* from six species of Callithricidae. *Proc. Am. Assoc. Zoo Vet.* 95–97.
- Woodward, R.A., and Weld, K.P. (1997). A comparison of ketamine, ketamine–acepromazine, and tiletamine–zolazepam on various hematologic parameters in rhesus monkeys (*Macaca mulatta*). *Contemp. Top. Lab. Anim. Sci.* **36**(3), 55–57.
- Woolfson, M.W., Foran, J.A., Freedman, H.M., Moore, P.A., Shulman, L.B., and Schnitman, P.A. (1980). Immobilization of baboons (*Papio anubis*) using ketamine and diazepam. *Lab. Anim. Sci.* **30**, 902–904.
- Yeoman, R.R., Williams, L.E., Hazelton, J.M., Ricker, R.B., and Abee, R.C. (1988). The effects of brief manual restraint, prior conditioning and ketamine sedation on lutenizing hormone and estradiol levels in the female Bolivian squirrel monkey. *Am. J. Primatol.* **14**(4), 454–455.
- Zola-Morgan, S., and Micheletti, C. (1986). Respiration rate, heart rate, and body temperature values in cynomolgus monkeys (*Macaca fascicularis*) during barbiturate anesthesia. *J. Med. Primatol.* **15**, 399–408.

PERSONAL COMMUNICATIONS

- Bernal, J.E. (2006). DVM, Preclinical Technical Services, 713-435-9542; preclinicaltechnicalservices@msn.com
- Brady, A. (2007). (p 23) Ctr. for Neotropical Primate Res. & Resources, 251/460-6239, abrady@usouthal.edu
- Hojabri, A. Charles River Laboratories, PCS-Montreal, 514-630-8200 (extn. 8733).
- McTighe, M.S. (2008). Clinical Veterinarian, Alamogordo Primate Facility/ Charles River. 575-679-3811; maggie.mctighe@crl.com
- Morris, T. (1995). (p 11) GlaxoSmithKline; Timothy_H_Morris@gsk.com
- Niekrasz, M.A. (2006). Dipl.ACLAM, Assistant Professor of Surgery, University of Chicago ARC. 773-834-2024; maniek@arc-1.bsd.uchicago.edu
- Swenson, B. (1995). Consulting Veterinarian. (770), 931–1717.
- Theriault, B.R. (2006). Clinical Veterinarian, Dept. Surgery/ARC University of Chicago, 773-702-9362; betty@arc-1.bsd.uchicago.edu

This page intentionally left blank

Chapter 13

Anesthesia and Analgesia in Dogs and Cats

Elizabeth Armitage-Chan

I. Introduction	366
II. Preanesthetic Considerations	366
A. Historical Information	367
B. Physical Examination	367
C. Laboratory Data	367
D. Preanesthetic Preparation	367
III. Anesthetic Techniques	368
A. Routes of Drug Administration	368
B. Chemical Restraint	368
C. Endotracheal Intubation	368
D. Anesthesia Using Inhaled Agents	369
E. Total Intravenous Anesthesia (TIVA)	369
F. Neuromuscular Blocking Agents	370
IV. Preanesthetic Medications	370
A. Sedatives	370
B. Opioids	371
C. Anticholinergic Agents	371
V. Induction of Anesthesia	372
A. Propofol	372
B. Barbiturates	372
C. Etomidate	372
D. Dissociative Anesthetics	373
E. Alphaxalone	373
F. Other Long-Acting Injectable Agents	373
G. Volatile Agents	373
VI. Anesthetic Maintenance	374
A. Volatile Anesthetics	374
B. Agents for Total Intravenous Anesthesia	375
VII. Monitoring	375
A. Depth of Anesthesia Monitoring	375
B. Physiological Monitoring	375
VIII. Supportive Care	376
IX. Recovery	377
X. Analgesia	377
A. Opioids	378
B. NSAIDs	378

C. Local Anesthetics	379
D. Ketamine	380
XI. Specific Considerations	380
A. Breed Variability	380
B. Craniotomy and Intracranial Lesions	380
C. Thoracotomy	380
D. Cardiovascular Conditions	381
E. Orthopedic Conditions	381
F. Cesarean Section	382
G. Neonatal Anesthesia	382
H. Prolonged Anesthesia	382
I. Considerations for Cats	382
Suggested Additional Reading	383
References	383

I. INTRODUCTION

Dogs and cats have a long history of being used as research models. Their extensive use in laboratory animal medicine, together with the wide range of procedures performed in clinical veterinary medicine, indicates that there is a huge selection of reported anesthetic protocols, each with individual benefits and disadvantages. This diversity in published anesthetic techniques can be overwhelming when attempting to determine the optimal anesthetic protocol for use in a particular animal model. In addition, there are important differences between cats and dogs in their responses to anesthetic and analgesic agents, and it is important to recognize that cats should not be treated as miniature dogs, but instead require special consideration.

Selection of anesthetic agents depends on many criteria, including provision of analgesia for invasive procedures, minimization of effects on investigated parameters, and maintenance of stable physiological homeostasis, thus minimizing the risk of unexpected intraprocedural complications and mortality. The state of general anesthesia includes the provision of all components of the anesthetic triad: loss of consciousness and retrograde amnesia, analgesia (absence of sensation of noxious stimuli), and muscle relaxation. This concept of balanced anesthesia cannot be provided by a single agent—there are no anesthetics available that meet all these criteria—and therefore, combinations of several agents are used. Use of anesthetic and sedative agents in combination is also recommended to reduce the required doses of individual drugs, thereby minimizing the adverse physiological effects that occur at higher concentrations. When devising an anesthetic protocol, it is therefore important to include sedation (for some procedures, utilization of heavy sedation is an acceptable alternative to general anesthesia), analgesia (both preemptive and into the postoperative period), anesthetic induction and maintenance agents, as well as means to provide perioperative monitoring and physiological support.

The plan to either recover the animal from the anesthesia, or euthanatize it while still anesthetized, is an important factor when designing the anesthetic protocol. If the animal is

not being recovered, agents that have unfavorable recovery characteristics (for example, a prolonged duration of effect or unacceptable emergence phenomena) can be utilized. In this situation, although it remains imperative to prevent sensory transmission of noxious stimuli during the operative period, ongoing pain management does not require consideration. In situations where ongoing analgesia cannot be adequately provided, euthanasia while still anesthetized may be the most acceptable and humane option.

Since the first edition of this book, developments have been made in a number of areas relevant to the anesthetic management of laboratory animals. Newer agents such as medetomidine, propofol, nonsteroidal anti-inflammatory drugs (NSAIDs) (carprofen, meloxicam, etodolac, and deracoxib), and new volatile anesthetics (isoflurane, sevoflurane, and desflurane) have become commonplace in clinical anesthesia of dogs and cats; there have been improvements in perianesthetic care, with concomitant decreases in anesthetic-related mortality (Brodbeck et al., 2005), and new concepts in pain management. All of these can be extrapolated for use in laboratory animal anesthesia. Such developments will improve the overall management of the animal, while under anesthesia, and increase the chance of a successful anesthetic outcome, enhance the well-being of the animal in terms of relief from pain and stress, and provide options for tailoring the anesthetic technique to meet the requirements of the research model.

II. PREANESTHETIC CONSIDERATIONS

A number of preparatory steps should be undertaken prior to anesthetizing the animal. These include assessment of the animals' health status, which is important in predicting as accurately as possible the response to anesthetic agents. Many anesthetics can adversely affect cardiovascular, respiratory, central nervous, hepatic, renal, or gastrointestinal function, particularly if a preexisting disease is present. Infectious, congenital, or developmental disorders (such as cardiac disease, respiratory tract infection, gastrointestinal disorders, and chronic renal or

hepatic disease) can occur even in purpose-bred animals with optimal husbandry.

A. Historical Information

In combination with physical examination of the animal, historical information (e.g., obtained from daily records or vendor profiles) may reveal unexpected abnormalities in health status that may alter the animals' responses to general anesthesia. Although anesthetic risk may not be increased, any deviation from completely normal health may alter the response to anesthesia and surgery in such a way that the data obtained are unusable, making an individual unsuitable for a particular study. Even in healthy animals, individuals of the same species can have varying responses to sedatives and anesthetics (Barter et al., 2004), and therefore information regarding previous anesthetic procedures is extremely helpful. It is important that daily records are kept up to date, and they should be scrutinized in detail before an animal is anesthetized, to ensure that there have been no recent events that may influence the response to anesthesia and surgery.

B. Physical Examination

Besides the requirement for up-to-date animal history, it is important to perform a physical examination of the animals to be anesthetized prior to the procedure. When performed frequently on each individual, any deviation from the normal physical examination can be readily detected, and should prompt further investigation before the animal is deemed suitable for general anesthesia.

Minimum requirements for the physical examination should include collection of baseline values for heart rate, respiratory rate, and rectal temperature (see Table 13-1 for normal ranges), auscultation of the thorax for abnormal respiratory or cardiac sounds, palpation of the abdomen, examination of mucous membrane color and capillary refill time, and assessment of peripheral pulse quality. Assessment of the animal's

behavior (abnormal behavior may indicate disease or pain) and temperament are also important parts of the physical examination. Although it may be tempting to use the same anesthetic drug combinations for all animals within a group, an individual that is more anxious or nervous will require higher sedative doses to achieve the same level of sedation as an animal that is more relaxed. Similarly, the presence of pre-existing pain will mean that more analgesics are required following a particular procedure than would be required for the same procedure in an animal not initially in pain.

C. Laboratory Data

The benefits of preanesthetic laboratory data are controversial. Several studies (Roizen, 2005) indicate that, for patients undergoing minimally invasive procedures, who are free from systemic disease (on the basis of historical and physical examination data), anesthetic management is not altered by the availability of laboratory data. Despite this, preanesthetic blood testing is routinely performed in many human and veterinary hospitals. Laboratory testing should, in the first instance, be dictated by history and physical examination findings—any abnormalities detected at this stage should be investigated further by laboratory evaluation. Many institutions advocate a baseline hematocrit and total protein level prior to anesthesia in all cases. This has a number of benefits: (1) it is quick, easy, and inexpensive to perform; (2) it provides preprocedural information which could be referred to in the event of intraoperative hemorrhage; and (3) the values are altered in many disease states. The test is very nonspecific—disorder of almost any organ system, as well as dehydration, will result in an abnormality in one or both parameters; however, it is a useful screening test to be used to direct further testing in the result of an abnormal finding. Blood glucose should be tested in very young animals, which are at risk of developing hypoglycemia.

D. Preanesthetic Preparation

Prior to anesthesia, animals should be fasted to reduce the risk of regurgitation and aspiration of gastric contents, and to minimize respiratory impairment. For dogs and cats, a period of 6–12 hours is sufficient; water should be available throughout this time and does not need to be removed until the animal is sedated. An intravenous (IV) catheter should be placed prior to induction of anesthesia; this ensures venous access if there is some complication during anesthetic administration, and facilitates IV administration of anesthetic agents (some of which are highly irritant, slow in onset, or ineffective if injected extravascularly). It is beneficial to do this after the preanesthetic sedation; in all but the most tractable of animals, the calming effect of the sedative minimizes the stress and struggle associated with catheterization. Suitable sites for venous catheter placement in dogs and cats are the cephalic vein (most common),

TABLE 13-1
NORMAL PHYSIOLOGICAL DATA IN DOGS AND CATS

	Canine	Feline
Heart rate (beats/min)	70–120 (large dogs have lower and small dogs higher values)	140–180
Respiratory rate (breaths/min)	10–30 (or panting if excited)	15–30 (panting not a normal finding)
Capillary refill time (seconds)	<2	<2
Rectal temperature	100.5–102.5°F 38–39°C	100.5–102.5°F 38–39°C
Hematocrit (%)	37–55	31–46
Serum total protein (g/dl)	6.0–7.5	6.0–8.4
Blood glucose (mg/dl)	60–110	70–140

and the medial and lateral saphenous veins. Placement of jugular venous catheters, if required, is best performed under heavy sedation or general anesthesia. Good restraint is required during catheter placement; the dog or cat should be held with the limb extended and the head under control. The skin over the vein should be clipped and aseptically prepared, and following catheter placement, the catheter should be firmly secured with tape. If the animal is to be left unattended, some means of preventing the catheter being chewed out may be required (additional bandaging, or an Elizabethan collar).

Additional preparation is focused on consideration of complications (e.g., hemorrhage, hypothermia, bradycardia, hypoventilation, or apnea), preparing for their occurrence (e.g., availability of additional IV fluids, external heating devices, and means to support ventilation), and ensuring correct functioning of the anesthetic machine and monitoring equipment. The equipment used for the administration of anesthetics is described in detail in Chapter 6, and will not be discussed here.

III. ANESTHETIC TECHNIQUES

A. Routes of Drug Administration

A number of different routes are available for the administration of anesthetics, although some agents are only effective when administered by a particular route. In dogs and cats, injectable agents are most frequently given by IV, intramuscular (IM), and subcutaneous (SQ) injection. IM or SQ routes are useful for the administration of preanesthetic sedatives; compared to IV dosing, these are technically easier, quicker, and evoke less stress for the unsedated dog or cat. IM injections can be performed into the muscles of the cranial thigh (quadriceps), or the lumbar epaxial muscles. Injections into the caudal thigh (the semimembranosus and semitendinosus muscles) risk damaging the sciatic nerve and are associated with inferior uptake of drug compared to that injected into the quadriceps and lumbar spinal musculature (Autefage et al., 1990). Compared to SQ injection, uptake and onset of the action of IM-injected drugs is more rapid and reliable. In addition, once under anesthesia, decreases in the animal's peripheral perfusion (due to decreased cardiac output, use of vasoconstrictors, or hypothermia) decrease the uptake of SQ drugs and may render them unpredictable or ineffective. Intraperitoneal injection of anesthetics is also reported; however, this has disadvantages over IM or SQ dosing, including the risk of organ laceration, and increased stress and discomfort. The ease of IM injections in dogs and cats make intraperitoneal drug administration unnecessary.

For induction of anesthesia, IV drug administration is usually the preferred method. When administering rapidly acting anesthetic agents intravenously, they can be titrated exactly to the desired effect (often the stage at which endotracheal intubation is possible), minimizing the risk of inadvertent under-

overdosing. This is also preferable to induction of anesthesia by inhaled gases, which increases personnel exposure to volatile agents, increases the risk of regurgitation, and is more difficult to titrate accurately. Total inhalation anesthesia, i.e., without the use of an injected induction agent, has also been associated with increased anesthetic mortality in some species (Johnston et al., 1995). Once anesthesia has been induced, it can be maintained using either inhaled or IV agents.

B. Chemical Restraint

A state of heavy sedation can be obtained by using a single dose of IV- or IM-injected sedative or anesthetic. In some cases, this may be preferred to ongoing anesthetic administration, and some procedures can be adequately performed under heavy sedation. In general, such procedures should be noninvasive (do not require entry into a body cavity) and nonpainful, examples including imaging studies [radiography, magnetic resonance imaging (MRI)] and minor instrumentation (e.g., placement of central and arterial catheters). When the patient is under such deep sedation that they are immobile and unresponsive to stimulation, they should be considered to be anesthetized, and therefore monitored and supported as such, as adverse effects on cardiovascular and respiratory functions are frequently as severe as those that occur during a traditional anesthetic. To obtain sustained immobilization with a single injection, large drug doses may be required, with a resultant increase in the severity of adverse drug effects. IM sedative combinations that are suitable for the provision of chemical restraint in healthy animals include ketamine/midazolam or ketamine/medetomidine combinations in cats and medetomidine/opioid combinations in dogs. The dosing information for these drug combinations is provided in Table 13-2.

C. Endotracheal Intubation

Whether anesthesia is maintained with a volatile or injectable agent, endotracheal intubation is recommended as a means to provide supplemental oxygen, prevent aspiration of material into the respiratory tract, and enable ventilatory support in the event of hypoventilation or apnea. All anesthetics in common usage depress the respiratory system, and therefore there is a risk of hypoxemia if oxygen is not administered. The use of an endotracheal tube instead of a facemask reduces environmental contamination and exposure of personnel to anesthetic gases. Maintenance of a patent airway can also be achieved using tracheostomy or a laryngeal mask; however, endotracheal intubation is the easiest method and is associated with few complications. The larynx of both the dog and the cat can be easily visualized with the aid of a laryngoscope. Spasm of the arytenoid cartilages of the feline larynx immediately after anesthetic induction is a common occurrence that impedes the passage of an endotracheal tube; this reflex can be inhibited by

TABLE 13-2
SEDATIVE COMBINATIONS FOR USE IN DOGS AND CATS

	Route	Comments
Dogs		
Butorphanol 0.2 mg/kg + medetomidine 10–15 µg/kg	IM or IV (reduce dose by 50%)	Deep sedation, immobility. Profound cardiovascular effects. Antagonize using IM atipamezole (5 × medetomidine dose)
Acepromazine 0.02–0.05 mg/kg + butorphanol 0.2 mg/kg or morphine 0.5 mg/kg	IM or IV (reduce by 50% and avoid morphine)	Moderate sedation (acepromazine dose of 0.02 mg/kg results in mild sedation), usually ambulatory
Cats		
Ketamine 10 mg/kg + midazolam 0.2 mg/kg	IM	Deep sedation, minimal cardiovascular, and respiratory effects
Ketamine 5 mg/kg + medetomidine 15–20 µg/kg	IM	Deep sedation, profound cardiovascular effects. Antagonize with IM atipamezole (2.5 × medetomidine dose)
Ketamine 5 mg/kg + butorphanol 0.2 mg/kg + acepromazine 0.05 mg/kg	IM	Moderate sedation
Oxymorphone 0.1 mg/kg + acepromazine 0.05 mg/kg	IM	Mild sedation

Note: Doses are based on author's clinical use, and may differ from other published dose ranges.

the topical administration of 0.1 ml of a 2% lidocaine solution onto the larynx, using a 1 ml syringe with the needle removed (to avoid damage to the laryngeal mucosa), thus facilitating tracheal intubation. As large a diameter as possible, cuffed endotracheal tube should be selected to provide the best protection of the respiratory tract from fluid aspiration. The cuff should be slowly inflated, while simultaneously administering a positive pressure breath to a pressure of 15–20 cm water, until a leak around the tube can no longer be heard. Selection of a large tube, and inflation of the cuff in this way, provides airway protection without impairing tracheal mucosal perfusion (leading to pressure necrosis and rupture or tearing of the trachea), a particular problem in cats (Mitchell et al., 2000). Tracheal damage may also result from direct trauma caused by twisting of the endotracheal tube, most commonly during repositioning of the animal. To reduce this risk, the animal should be disconnected from the anesthetic breathing circuit during repositioning, such that movements of the breathing tubes do not result in movement of the endotracheal tube within the trachea.

D. Anesthesia Using Inhaled Agents

Volatile anesthetic agents can be used for both induction and maintenance of general anesthesia. The dose requirements are similar across the species, and therefore similar inhaled concentrations are used in dogs and cats. Incorporating nitrous oxide into the carrier gas mixture helps to decrease the amount

of volatile agent required, although the reduction achieved by using nitrous oxide is less marked in the cat compared to other species, particularly humans. Advantages of volatile anesthetics are that they are eliminated through the respiratory tract and thus are nondependent on metabolism for recovery, and that they can be easily titrated, enabling rapid increase and decrease in anesthetic depth (particularly with the newer, lower solubility agents). Most volatile agents also provide muscle relaxation, thereby fulfilling two components of the anesthetic triad. Analgesia, the third component of a balanced anesthetic, is minimal and insufficient for painful procedures after which the animal is to recover. Disadvantages compared to injected anesthetics include the need for specialist equipment for administration (vaporizer, anesthetic machine, gas source, breathing circuit, and scavenge system) and environmental contamination, resulting in personnel exposure and atmospheric pollution. Cardiovascular and respiratory depression occurs and is dose related, increasing the concentrations increasing the severity of hypotension, hypoventilation, and bradycardia. Volatile anesthetics decrease cerebral oxygen requirement; therefore, low doses decrease intracranial pressure (ICP). However, higher doses cause cerebral vasodilation (which may be augmented by hypercapnia if ventilation is not assisted), and therefore ICP is elevated.

E. Total Intravenous Anesthesia (TIVA)

With a few exceptions (very long-acting injectable agents), the alternative to maintaining anesthesia with a volatile agent is

to use a continuous IV infusion of the anesthetic agent. TIVA may be required because of a contraindication to volatile agents (e.g., malignant hyperthermia susceptibility), or if the location of the procedure dictates that an anesthetic machine is not available (e.g., within an MRI scanner). Although exceedingly rare, malignant hyperthermia has been reported in dogs and cats (Bellah et al., 1989; Nelson, 1991), and if the research population has this genetic mutation, a total IV technique must be employed. If TIVA is selected and the animal is to be recovered at the end of the procedure, it is appropriate to select a short-acting, rapidly eliminated drug, to minimize drug accumulation and prevent excessively long recovery time. Propofol is frequently used for this purpose, although accumulation and prolonged recovery may occur in cats. Most TIVA protocols have cardiovascular and ventilatory effects that are comparable to anesthesia using a volatile agent, and therefore supplemental oxygen should be provided and cardiovascular parameters monitored.

F. Neuromuscular Blocking Agents

In the anesthetic management of humans, neuromuscular blocking agents such as suxamethonium and vecuronium are frequently used to enable orotracheal intubation and to suppress the patient's own respiratory efforts during mechanical ventilation. In consequence, many anesthetic protocols devised for dogs and cats in research include neuromuscular blockers. However, in these species, neuromuscular blockade is not required for either intubation or assisted ventilation. Neuromuscular blocking agents, such as atracurium, are used for intraocular surgery, where it is necessary to keep the eye in a central position, and are sometimes used in delicate surgical procedures close to vital structures, where small movements by the patient could be disastrous (for example, some neurological or vascular surgery). However, for the most part, nearly all procedures can be adequately performed without muscle paralysis. Whenever a neuromuscular blocker is used, respiratory muscles are paralyzed, and therefore ventilation must be assisted. There is also a loss of the skeletal muscle activity that is usually utilized to assess anesthetic depth, such as the palpebral reflex, and loss of tone of the jaw musculature. It is therefore more difficult to ensure that the animal is adequately anesthetized, and that analgesia is sufficient. The anesthetist must instead rely on cardiovascular parameters as an indicator of analgesia and anesthetic depth; however, interpretation is complicated by other factors that alter cardiovascular activity, such as plasma-volume status, hemorrhage, and acid-base changes. Neuromuscular blockers should only be used in combination with general anesthesia, and it is extremely unethical to administer these agents without a coadministered anesthetic. Whenever neuromuscular blockers are utilized, institutional ethics committees should demand to be fully satisfied that a state of unconsciousness would be ensured.

IV. PREANESTHETIC MEDICATIONS

A. Sedatives

The aims of the preanesthetic medication are to sedate the animal, to provide a smooth, controlled anesthetic induction and recovery with minimal excitement phase, to reduce the doses (and adverse effects) of anesthetic induction and maintenance agents, and to provide analgesia, where necessary, for painful procedures. The preanesthetic medication (the premedicant) therefore usually includes both a sedative and an analgesic component. Drug combinations are preferable to the use of a single agent; the combination of different drug classes has a synergistic effect on sedation, producing a better result with lower drug doses. Even in healthy animals, the dose-reducing effects of the drug combinations are beneficial as the depressant effects of anesthetics and sedatives on cardiovascular function are dose-related and nonlinear, and escalate dramatically above the normal clinical dose range. Table 13-2 lists some recommended sedation combinations.

1. Acepromazine

Acepromazine is a very commonly used sedative in dogs and cats. It is used to provide sedation and anxiolysis, facilitating animal handling and procedures such as IV catheterization. The dose range (when combined with additional agents) is 0.02–0.05 mg/kg, with cats requiring the higher doses. Larger dogs tend to require lower mg/kg doses than small breeds, and few dogs require more than a total dose of 3 mg. The doses within the clinical range tend to produce sedation of 6–12 hour duration, although there is much interindividual variability and, particularly in dogs, at doses exceeding 0.05 mg/kg the intensity of sedation is not significantly increased, but duration of action will become very prolonged (Hall, 1991). Reduction in volatile anesthetic requirement is maximal at 0.06 mg/kg (Heard, 1986). The main adverse effect is antagonism of vascular α_1 -adrenoreceptors, resulting in vasodilation, decreased systemic vascular resistance, and arterial hypotension. This is usually insignificant within the recommended dose range in the healthy animal; however, it will cause cardiovascular collapse in an animal with hypotension or hypovolemia (for example, experimentally induced sepsis or hemorrhage). Historically, drugs related to acepromazine (phenothiazines) have been associated with a decrease in seizure threshold, and have been avoided in seizure-risk animals. Although this may be the case for some phenothiazines, there is no evidence that acepromazine increases seizure risk, particularly at the doses recommended for clinical use, and most clinical anesthesiologists are comfortable using these doses of acepromazine in animals with seizure disorders.

Sedation is enhanced when acepromazine is combined with opioid agents, either pure agonists (such as hydromorphone,

morphine), when there is an additional beneficial analgesic effect, or agonist–antagonists (butorphanol). The combination of butorphanol with acepromazine produces sedation in dogs with minimal effects on heart rate and respiratory function, and is a useful premedicant for nonpainful procedures. Opioid–acepromazine combinations are less effective in cats; however, sedation can be improved by adding ketamine to the drug combination.

2. α_2 -Adrenoreceptor Agonists

The most commonly used α_2 agonist in dogs and cats is medetomidine; others include xylazine and dexmedetomidine. All these agents produce deep sedation, even when used in low doses, in both cats and dogs. When high doses are used, often in combination with ketamine or an opioid, deep sedation or anesthesia is accompanied by severe cardiovascular effects (vasoconstriction, bradycardia, and decrease in cardiac output). Although heart rate increases, stroke volume is decreased by the addition of an anticholinergic (Alibhai et al., 1996), and therefore overall cardiac performance is not improved. In addition, the use of anticholinergics with α_2 agonists increases the work of the heart, thus, risking myocardial injury. In general, the addition of an anticholinergic is therefore unnecessary, although may be tolerated in young healthy animals without cardiovascular compromise. Even low doses of α_2 agonists depress the cardiovascular system more than is seen with other commonly used anesthetic and analgesic agents, and therefore, the use of α_2 agonists is restricted to young (not neonatal), healthy animals that are undergoing simple procedures with a low risk of complications. Compared to use as a premedicant, they are much more useful in combination with butorphanol (in dogs) or ketamine (in cats) for chemical restraint for noninvasive procedures that do not require general anesthesia. Because of the cardiovascular effects, animals that have been given these drugs should always be closely monitored, regardless of whether the animal is subsequently anesthetized. Monitoring is complicated by the cardiovascular effects, which typically result in pale/cyanotic mucous membranes and poor peripheral pulse quality (often pulses cannot be palpated), many monitors (pulse oximetry, oscillometric blood pressure) failing or becoming inaccurate in these conditions.

The advantage of the α_2 agonists is the availability of an antagonist, which completely reverses both sedative and cardiovascular effects. Medetomidine and dexmedetomidine can be antagonized using atipamezole (the dose is 5 times the administered dose of medetomidine, or 10 times the dose of dexmedetomidine in dogs; half this dose is given to cats). Except in an emergency, when it should be given intravenously, atipamezole is best administered by the IM route to avoid excessively rapid recovery and associated tachycardia, arrhythmias, and hypertension. Onset of action is fast, and signs of recovery are typically observed within 2–5 minutes of IM administration. It should be noted that the analgesic effects of the α_2

agonist would also be reversed following the administration of atipamezole.

3. Benzodiazepines

Drugs in this category include diazepam and midazolam. Clinically, benzodiazepines are useful in high-risk patients, as they have no significant cardiovascular and respiratory effects at usual doses. However, they produce little or no sedation in healthy dogs and cats, and paradoxical excitement is occasionally seen in both species. They may be used in combination with an opioid to provide light sedation prior to anesthesia. A dose-sparing effect on volatile agents is reported; however, this is less pronounced compared to that of other sedatives. Anecdotally, the quality of sedation achieved appears to be better when benzodiazepines are administered intravenously than by the IM route. Benzodiazepines are also muscle relaxants and therefore are useful to counteract ketamine-induced muscle rigidity.

B. Opioids

Opioids have both sedative and analgesic properties, and are commonly used as a component of the anesthetic premedication. Pure agonists, such as morphine, hydromorphone, methadone, and oxycodone, are excellent analgesics in both dogs and cats. Partial agonists (buprenorphine) provide less-potent analgesia, which is suitable for minimally painful procedures; however, sedation is also less intense than that achieved using pure agonists, or kappa-receptor agonists such as butorphanol. Side effects of the opioids, particularly pure-agonist agents, include vomiting and mild respiratory depression, which is usually insignificant in the awake animal. Once anesthetized, animals that have had large doses of opioids may require assisted ventilation; the need for this can be evaluated by capnometry. Because of the minimal effects of the opioids on the cardiovascular system, large doses can be used to reduce the requirement for other sedative and anesthetic drugs if a cardiovascular-sparing protocol is required (e.g., for cardiovascular studies). High doses frequently cause bradycardia, which can be treated using an anticholinergic agent. Morphine and meperidine can cause histamine release, and therefore should not be administered intravenously (morphine can be administered by very slow IV infusion); all other opioids can be administered by any parenteral route.

C. Anticholinergic Agents

Anticholinergics inhibit neurotransmission in the parasympathetic nervous system and include atropine (0.02–0.04 mg/kg) and glycopyrrrolate (0.01–0.02 mg/kg). They are typically used in the anesthetic period to counteract the sympatholytic and vagal stimulant effects of most anesthetics, particularly high

doses of opioids, and thus prevent vagally mediated bradycardia. Other causes of increased vagal tone are also indications for the use of anticholinergics, and include young age (less than 6 months old), and surgical procedures of the eyes and peri-orbital region, stimulation of which may elicit an oculocardiac reflex with profound bradycardia. They are also useful to prevent hypersalivation associated with ketamine use in cats, which can lead to respiratory obstruction.

When indicated, the anticholinergic agent is usually incorporated into the premedicant drug combination. Anticholinergics can also be used intraoperatively to treat parasympathetic-associated bradycardia. Titration of dose to desired effect is not possible, and marked tachycardia may follow anticholinergic use. Paradoxically, a transient period of bradycardia or atrioventricular block may be seen immediately after drug administration.

V. INDUCTION OF ANESTHESIA

A. Propofol

Propofol is widely used for induction of anesthesia in many species. Its main benefit is a rapid and complete anesthetic recovery: after a single injection, recovery usually occurs within 10–20 minutes, and is associated with minimal residual sedation. Like all IV anesthetic induction agents, propofol should be administered only until the desired anesthetic depth is reached (generally to allow endotracheal intubation), and the dose required to achieve this depends on the extent of preanesthetic sedation and the health status of the animal. However, most dogs and cats are anesthetized with a dose of propofol of up to 4 mg/kg. The most significant adverse effects of this agent are vasodilation, leading to arterial hypotension, and apnea. These are particularly profound following rapid injection, and propofol should always be administered slowly, over a period of 30–60 seconds. Propofol has been associated with anemia, anorexia, prolonged anesthetic recovery, and general malaise when used on consecutive days in cats (Matthews et al., 2004), and therefore if anesthesia is required on a daily basis, an alternate induction agent should be used in this species. The use of contaminated propofol has been associated with surgical wound infections in dogs (Heldmann et al., 1999); this likely relates to the ability of the lipid and glycerol-based solvent to support bacterial growth, and emphasizes the importance of discarding opened vials after 6 hours. Propofol does not have any analgesic properties, and when used without adequate preanesthetic sedation, is often associated with an excitement phase, with myoclonus and paddling frequently observed. Some animals exhibit a marked pain response when propofol is injected. Although this is sometimes erroneously attributed to extravascular injection, it more likely indicates correct IV injection, and appears to occur most commonly when a small vein is used. This

response can be blunted by a small dose of lidocaine (0.5 mg/kg in dogs, 0.1–0.2 mg/kg in cats) given intravenously immediately prior to propofol administration.

B. Barbiturates

Barbiturate drugs suitable for induction of anesthesia include thiopental (sodium pentothal) and sodium pentobarbital. Previously, thiamylal and methohexital were also widely used; however, these short-acting barbiturates have largely been superseded by propofol. Thiopental is a useful induction agent in both dogs and cats; when compared to propofol, it is currently more cost-effective, does not support bacterial growth, and is safer to use for consecutive day dosing in cats. As with propofol, apnea and hypotension may occur immediately following anesthetic induction. The duration of action is longer than propofol, a single injection (usually dosed at up to 10 mg/kg, but dependent on anesthetic premedicant) provides 20–30 minutes of anesthesia, and residual sedation may persist for several hours after recovery. Recovery quality can be poor if additional sedative agents have not been administered. Thiopental is available in several concentrations; however, because of the high pH of the solution, concentrations greater than 2.5% should not be used in small animals. The high alkalinity solution is a tissue irritant, and skin necrosis and sloughing can occur following extravascular injection. Thiopental should therefore only be administered via an IV catheter. With both thiopental and pentobarbital, administration of multiple doses results in drug accumulation and markedly prolongs recovery. None of the barbiturates have any analgesic effect, and a weak anti-analgesic effect is described. It is therefore necessary to provide analgesia if painful procedures are performed.

Pentobarbital is longer-acting than thiopental and may be useful in prolonged anesthetic procedures. Depending on the premedicant selected and dose used, a single dose of 15 mg/kg pentobarbital may provide 1–2 hours of anesthesia without the need for an additional maintenance agent (Hatch et al., 1986; Hsu, 1985). Recovery can be associated with excitement and paddling, and residual sedation persists for several hours. Therefore, alternate agents are often selected if the animal is to recover from anesthesia. The therapeutic index of pentobarbital is narrow (doses of 4–5 times the anesthetic dose are used for euthanasia), due to marked respiratory depression, vasodilation, and direct myocardial effects. Close attention to dose and physiological monitoring is therefore required and oxygen should be provided, with the ability to support ventilation if necessary.

C. Etomidate

Etomidate is popular in cardiovascular studies because it elicits no changes in cardiovascular function. There is a high

incidence of associated excitement, which may include paddling, vocalization, panting, urination, and defecation, particularly if preanesthetic sedation is inadequate. An important effect of etomidate is suppression of glucocorticoid synthesis by the adrenal gland. This is particularly pronounced if etomidate infusions are used; however, even single doses have an effect, reducing cortisol production for up to 6 hours in dogs (Dodam et al., 1990) and cats (Moon, 1997). The adrenal effects of etomidate infusion have been associated with increased mortality in people (Newby and Edbrooke, 1983), and therefore prolonged etomidate administration is not recommended.

D. Dissociative Anesthetics

The dissociative anesthetics in common use are ketamine and tiletamine (as a component of Telazol™). Ketamine is a useful anesthetic agent in dogs and cats: in combination with a benzodiazepine (ketamine 5 mg/kg, benzodiazepine 0.25 mg/kg), IV injection produces rapid induction of anesthesia that lasts for 20–30 minutes. It can also be given by IM injection and, particularly in cats, it is a useful sedative (Table 13-2). When used in combination with other anesthetics, it imparts few cardiovascular or respiratory effects, and has minimal effects on other organ systems. In high doses, or when used with minimal other anesthetics or sedatives, sympathomimetic effects are unmasked, and in these circumstances ketamine can cause tachycardia (most commonly), hypertension, and increased arrhythmogenicity. In most clinical cases, however, the use of ketamine is associated with cardiovascular stability. Ketamine is also reported to have direct myocardial depressant effects; however, these are only unveiled in the absence of an intact sympathetic nervous system (e.g., in bilateral adrenalectomy or high thoracic subarachnoid anesthesia). Because of the nature of dissociative anesthesia, ketamine does not produce global dampening of central nervous function, and may increase neuronal activity in certain regions of the brain. For this reason, it is avoided in animals with a seizure risk, or in those that have intracranial lesions. Electroencephalographic recordings may also be affected. Unlike other induction agents, ketamine has some analgesic activity, and provides a valuable component to multimodal analgesic strategies. The minimal effects on physiological homeostasis, and the provision of a small amount of analgesia, make it a useful agent for anesthesia induction.

Tiletamine, usually used in combination with zolazepam, has properties similar to those of ketamine, and can be administered by IV or IM injection. In clinical practice, it is often given intramuscularly to control aggressive dogs and cats, due to its deep sedation effects. Adverse effects are similar but of greater intensity than ketamine—tachycardia and hypertension are more commonly observed, and there is a longer duration of sedative action. Recovery from tiletamine–zolazepam is unpredictable, and unfavorable emergence reactions are common.

E. Alphaxalone

Alphaxalone is a steroid anesthetic that is associated with minimal cardiovascular and respiratory effects. It can be administered by IV or IM injection, and provides anesthesia of approximately 20 minutes duration. It is noncumulative; therefore, doses can be repeated to prolong anesthesia without prolonging recovery time. The previously available formulation (Saffan™) had a Cremophor solvent which caused histamine release and which prevented its use in dogs (due to a high incidence of anaphylactoid reactions). However, a new Cremophor-free formulation (Alfaxan™, cyclodextran-based) has been introduced in Europe and Australia, and is likely to be available in the near future in the United States. This preparation does not cause histamine release and is suitable for IV administration in both cats and dogs. The short duration of action, rapid and complete recovery, and minimal cardiovascular and respiratory effects make this agent ideal for short procedures. Excitement can occasionally be seen during anesthetic recovery, particularly if the animal has not received a sedative as part of its premedicant; however, this can usually be prevented by providing a quiet environment, with minimal stimulation, in which the animal can recover. As with other induction agents, alphaxalone has no analgesic activity. Similarly to propofol, the cyclodextran preparation of alphaxalone contains no preservative; therefore, unused drug remaining in opened vials should be discarded.

F. Other Long-Acting Injectable Agents

Although rarely used in clinical veterinary medicine (due to unfavorable recovery characteristics), long-acting agents such as urethane, chloral hydrate, and chloralose are suitable for prolonged anesthesia or terminal studies, where delayed and unpredictable recovery is inconsequential. At clinical doses, these agents are typified by lack of cardiovascular effects, and are suitable for certain cardiovascular studies. Urethane requires specialist handling due to carcinogenic properties. Chloral hydrate and chloralose produce only a light plane of anesthesia at doses supporting cardiovascular and respiratory function; higher doses producing deeper anesthesia cause respiratory depression. These agents are used only rarely, but where the animal is going to be euthanized, without recovering from anesthesia, they may be useful.

G. Volatile Agents

The use of volatile agents for induction of anesthesia is occasionally necessary for certain investigations, but has a number of disadvantages. The anesthetic agent may be delivered using either a facemask or induction chamber (suitable for cats and small dogs); however, many facemasks do not closely conform to the variable anatomy of the canine and feline face. This leads

to leakage of gases around the mask, diluting the inhaled anesthetic mixture and slowing anesthetic induction. In addition, use of a mask that is too large will increase equipment dead space, increasing the work of breathing and causing rebreathing of carbon dioxide. Volatile agent induction methods invariably lead to environmental contamination and exposure of personnel to high levels of anesthetics. If the animal has not been adequately sedated prior to anesthetic induction, there is often a marked excitement phase; the animal will struggle and become stressed, leading to catecholamine release with resultant hypertension and arrhythmias. It is therefore recommended to sedate the animal, if possible prior to an inhalant anesthetic induction, if such a technique is necessary. Once the animal is adequately anesthetized, the trachea should be intubated for ongoing anesthetic administration.

In order to achieve a rapid anesthetic induction, the newer, low-solubility agents (isoflurane and sevoflurane) are preferred over higher solubility agents (halothane). The addition of nitrous oxide to the inhaled gas mixture (ensuring a delivered oxygen component of at least 30%) further accelerates anesthetic induction. Desflurane, an even lower-solubility agent with faster pharmacokinetics, is not suitable for use as an induction agent due to its low potency (high concentrations are required for anesthetic induction, which are difficult to deliver), airway irritation, and ability to cause high levels of catecholamine release in lightly anesthetized animals ("sympathetic-storm"). Compared to sevoflurane, isoflurane has a more noxious smell and causes a higher incidence of airway irritation; therefore, where there is a choice of agents, sevoflurane is usually selected. Once an adequate plane of anesthesia has been reached, it is acceptable to change volatile agents for ongoing anesthetic maintenance (usually after tracheal intubation).

VI. ANESTHETIC MAINTENANCE

Maintenance of anesthesia may be achieved using an inhaled volatile agent, or total IV technique.

A. Volatile Anesthetics

All the commonly used volatile anesthetics (halothane, sevoflurane, isoflurane, and desflurane) are suitable for use in dogs and cats, and the concentrations required for anesthesia (which depends on the administration of other analgesic and sedative agents, but is usually between 1 and 1.5 minimal alveolar concentration (MAC) with surgical stimulation) are shown in Table 13-3. Recovery from anesthesia is dependent on several factors including anesthetic solubility; it is most rapid from desflurane and slowest from halothane. Recovery from sevoflurane anesthesia is more rapid than from isoflurane; however the difference is frequently of minor practical significance,

TABLE 13-3

PHYSICAL CHARACTERISTICS OF VOLATILE ANESTHETIC AGENTS SIGNIFICANT FOR CANINE AND FELINE ANESTHESIA

	MAC (dogs)	MAC (cats)	Solubility (blood/gas partition coefficient)
Halothane	0.9	1.0	2.54
Isoflurane	1.3	1.6	1.46
Sevoflurane	2.3	2.6	0.68
Desflurane	7.2	9.8	0.42

TABLE 13-4

ACCEPTABLE RANGES FOR MEASURED PARAMETERS IN ANESTHETIZED DOGS AND CATS

Parameter	Acceptable range
Arterial blood pressure (mmHg)	Mean: 60–100 Systolic: 100–140
Heart rate (per minute)	Dogs: 60–140 Cats: 100–180
Arterial hemoglobin oxygen saturation (%)	>95
End-tidal carbon dioxide (mmHg)	30–55
Respiratory rate (per minute)	4–20

particularly after a long anesthetic duration. Recovery from inhalational anesthesia will be lengthened by prolonged anesthetic exposure, as well as by hypothermia and hypoventilation. The amount of anesthetic delivered (i.e., delivered percentage over the anesthetic period) and other anesthetic, analgesic, and sedative agents administered will also influence recovery time.

All the volatile anesthetics decrease heart rate, blood pressure, and minute ventilation; therefore, these should be closely monitored. A decrease in anesthetic administration is indicated if measured parameters fall below acceptable levels (Table 13-4). Halothane depresses cardiac output more than the other agents; however, systemic vascular resistance is better maintained than with the newer agents, which are more potent vasodilators. Halothane use is also associated with a higher incidence of cardiac arrhythmias, due to sensitization of the myocardium to catecholamines. Selection of volatile agent therefore depends on the procedure to be performed, any physiological derangements in the study animal, and any cardiovascular parameters of interest. Nitrous oxide can be added to the anesthetic gas mixture, reducing the amount of volatile agent required and the fraction of inspired oxygen. A small amount of additional analgesia is also provided. When using a nonrebreathing anesthetic circuit, a ratio of nitrous oxide to oxygen of up to 70:30 can be administered. However, when using a rebreathing circuit, particularly at low gas flow rates, the administered gas mixture should contain at least 50% oxygen and total gas flow should be at least 15 ml/kg/min (Haskins and Knapp, 1982). Chapter 6 elaborates on the use of different anesthetic breathing systems.

B. Agents for Total Intravenous Anesthesia

TIVA can be performed using a single injection of a long-acting agent, such as pentobarbital, or by administering an infusion or repeated incremental doses of short-acting agents. Thiopental accumulates with repeat dosing, and therefore recovery time is unacceptably long for clinical use. In dogs and cats, the most commonly selected agent for this purpose is therefore propofol, administered either by infusion (0.1–0.4 mg/kg/min) or by repeated bolus injections of 1–2 mg/kg. Administration by infusion produces a smoother anesthetic, and usually results in lower total propofol consumption. If necessary for accurate dosing, propofol can be diluted using 5% dextrose in water (D5W). Anecdotally, tolerance to propofol infusion has been noted in dogs, with prolonged anesthesia (several days duration) requiring escalating propofol doses. Anesthesia using propofol infusion in cats is not ideal, and although widely performed, this is generally due to lack of an acceptable alternative. Although propofol does not accumulate in dogs and therefore is ideal for repetitive or infusion use, impaired metabolism in cats means that it does accumulate (albeit to a less extent than thiopental), and therefore recovery is prolonged following propofol infusion (Pascoe et al., 2006). To minimize this problem, propofol dose can be reduced by coadministering additional agents such as fentanyl (0.3–0.7 $\mu\text{g}/\text{kg}/\text{min}$), morphine (1–4 $\mu\text{g}/\text{kg}/\text{min}$), ketamine (10–20 $\mu\text{g}/\text{kg}/\text{min}$), midazolam (0.35 $\mu\text{g}/\text{kg}/\text{min}$), or medetomidine (0.5–1.0 $\mu\text{g}/\text{kg}/\text{min}$). The use of morphine or fentanyl, as well as reducing propofol consumption and thereby improving cardiovascular and respiratory function, also has the advantage of providing analgesia. In contrast to other species, dogs and cats can generally not be anesthetized by an opioid infusion alone, and therefore always require an additional anesthetic agent. As with a volatile agent-based anesthetic technique, heart rate, respiratory rate, and blood pressure tend to decrease in a dose-related fashion. These should therefore be monitored, with appropriate steps taken to maintain acceptable cardiovascular and respiratory function.

VII. MONITORING

Negative effects on organ function and homeostasis are unavoidable in most anesthetic protocols. As previously discussed, most anesthetics depress the cardiovascular and respiratory systems, leading to decreased tissue oxygen delivery and risking organ damage and death. The most important means to minimize this effect and ensure a favorable outcome at the termination of anesthetic is to maintain the animal's anesthetic depth as light as possible, and use the minimum amount of anesthetic drugs, while ensuring immobility, lack of sensation of noxious stimuli, and lack of recall. Since anesthetic requirement varies among individuals, this requires close monitoring of anesthetic

depth and vital signs, supplementation with analgesics to reduce anesthetic dose, and provision of physiological support.

A. Depth of Anesthesia Monitoring

Monitoring anesthetic depth is similar in dogs and cats. As anesthetic depth increases, jaw tone drops, eyes rotate ventrally and medially, and palpebral reflex disappears. As the depth increases further, eye position reverses, regaining a central position, pupillary light reflexes are lost, and there is no corneal reflex. (It should be noted, however, that corneal reflexes should never be evaluated in an animal that may recover from anesthesia, due to the risk of corneal damage.) At this stage, anesthesia is too deep, severe cardiovascular dysfunction is probable, and such signs should prompt an immediate decrease in anesthetic delivery. Cardiovascular parameters are also valuable in assessing anesthetic depth; as anesthesia deepens, the heart rate and arterial blood pressure decrease. These changes are nonspecific, hypotension may result from hemorrhage and hypovolemia, and increase in heart rate may reflect anemia, hypoxemia, hypercapnia, pain, hypoglycemia, electrolyte abnormalities, and hypovolemia. If the anesthetist has no access to the face, anesthetic depth can also be evaluated by anal tone and limb withdrawal reflexes (both decrease as anesthesia deepens).

Electroencephalogram-based anesthesia monitors, such as bispectral index and spectral entropy, are also used to monitor anesthetic depth. The value and accuracy of these compared to the assessments described above are controversial, particularly in veterinary species. Although some reliability has been described in dogs anesthetized with a volatile agent (Greene et al., 2002), such measurements are highly dependent on anesthetic protocol, e.g., anesthetic depth when ketamine is used cannot be reliably evaluated (Hans et al., 2005). Bispectral index is also unreliable in anesthetized cats (March and Muir, 2003). Even if such a monitoring device is in place, because of the current lack of reliability in dogs and cats, it should not be used as an alternative to evaluation of reflexes and hemodynamic changes.

B. Physiological Monitoring

Monitoring respiratory and cardiovascular parameters is essential during the anesthetic period, due to the high risk of compromised function. Values outside the acceptable range (listed in Table 13-4) may indicate changes in anesthetic depth, or alert the anesthetist to a change in physiological status. Peripheral pulse quality is a useful indicator of cardiovascular function, and should be assessed even with the availability of electronic monitoring devices. Sites for palpation of peripheral pulses include the dorsal metatarsal, palmar metacarpal, and lingual arteries on the dorsomedial aspect of the hind feet, palmar aspect of the fore feet (proximal to the largest pad), and

ventral aspect of the tongue (either side of midline), respectively. These sites are preferred to the femoral pulses, as detection of peripheral pulse quality is a better indicator of cardiovascular function, femoral pulses persisting even with significant impairment of cardiac output. Mucous membrane color is a useful indicator of peripheral perfusion, and should remain pink, with a capillary refill time of less than 2 seconds, throughout the anesthetic period. Pallor or cyanosis may indicate hypothermia, hemorrhage or other causes of hypovolemia, or hypoxemia.

Additional monitoring equipment includes devices for blood pressure, oxygen saturation, and measurement of carbon dioxide and body temperature. Blood pressure monitoring is highly recommended, as perfusion of vital organs is dependent on a mean arterial pressure greater than 60 mmHg. This is usually assured when systolic pressure is greater than 100 mmHg, although very low diastolic pressure may occur if high concentrations of anesthetics are administered, which will cause a large drop in mean arterial pressure. Blood pressure exceeding acceptable range may indicate stress associated with pain or lightening of anesthetic depth, and is frequently an indicator that additional analgesics are required. Invasive blood pressure monitoring can be performed by placement of an arterial catheter attached to a manometer or transducer into the digital or femoral arteries; however, noninvasive methods of blood pressure monitoring require less technical expertise and are often equally valuable. Blood pressure monitoring by Doppler technique is the most common method in cats due to their small body size—this makes placement of arterial catheters more difficult, and many oscillometric blood pressure monitors fail to produce a reading.

Pulse oximetry and capnography are used to provide an indication of ventilatory function. Increases in end-tidal carbon dioxide (see Table 13-4) are usually caused by hypoventilation due to excessive anesthetic depth, although this may indicate equipment failure causing carbon dioxide rebreathing. Decreases may indicate hyperventilation (often associated with stress caused by pain or awareness), or may be caused by a decrease in cardiac output and pulmonary perfusion, increasing physiological dead space. A sudden drop in end-tidal carbon dioxide, which cannot be explained by equipment disconnection, should prompt urgent investigation into the possibility of cardiac arrest. Low values of oxygen saturation obtained by pulse oximetry typically indicate inadequacy of ventilation, although it can also occur if peripheral perfusion is compromised.

Monitors such as pulse oximeters and noninvasive blood pressure devices tend to work reliably in dogs and cats, although reliability decreases in the presence of poor cardiovascular function. In general, failure of these monitors or unexpected readings should provoke investigation into the well-being of the anesthetized animal, as most monitors function accurately in the uncomplicated animal, but develop inaccuracies and poor reliability if cardiovascular function is compromised.

The importance of temperature monitoring relates to the high incidence of hypothermia caused by anesthetic agents,

inhalation of cool, dry gases, exposure of open body cavities, and the use of surgical preparation solutions. Hypothermia results in a number of complications, which are described in the following section.

VIII. SUPPORTIVE CARE

Basic physiological support required by the majority of anesthetized animals includes IV fluids and a heat source. During the anesthetic period, the animal is not drinking, has increased insensible fluid losses due to evaporation (from the respiratory tract due to the inhalation of nonhumidified gases, and from open body cavities), and loses water due to translocation into traumatized tissues and hemorrhage. In the absence of excessive blood loss, infusion of 5–10 ml/kg/h of a balanced electrolyte crystalloid solution (such as lactated Ringer's solution, LRS) is recommended during the anesthetic period. Fluid replacement to compensate for blood loss should be in addition to this infusion rate; if colloids (e.g., hydroxyethyl starch) or blood products are used, the volume required is equal to the volume of blood lost. If crystalloids are used for volume replacement, administration of up to 3–4 times the volume of blood lost is required to maintain a euvoletic state (Muir and Wiese, 2004). Most healthy anesthetized dogs and cats can tolerate a loss of 10% of total blood volume (with appropriate fluid therapy); however, hemorrhage in excess of this requires transfusion of blood products. Since blood volume is approximately 90 ml/kg in dogs and 60–70 ml/kg in cats, a 15 kg dog would be at severe risk after a loss of 135 ml of blood, whereas a normal-sized cat can only afford to lose 30 ml of blood. In cats and smaller dogs, it is therefore particularly important to pay close attention to surgical hemorrhage.

Hypothermia is a common complication of anesthesia, and is a particular problem in cats and small or young dogs, due to an increased surface-area-to-volume ratio (which increases heat loss) and poor thermoregulation (impaired in neonates and suppressed by opioids and most anesthetics). Hypothermia-associated morbidity includes increased risk of surgical site infection, coagulopathy, cardiovascular and respiratory depression, and decreased metabolism of anesthetic drugs (hence prolonging recovery). Hypothermia-induced hypotension and bradycardia are poorly responsive to anticholinergic and sympathomimetic agents, hence are difficult to reverse and may be sufficiently severe to contribute to anesthetic death. Anesthetic requirement is closely related to body temperature, with a 5% decrease in MAC for every degree-centigrade temperature drop, and therefore inadvertent overdose may occur in the hypothermic animal. Unless hypothermia is a desirable component of the experimental protocol (e.g., for cardio- or neuroprotection during a decreased perfusion state), external heating devices (circulating warm water blankets, forced air warmers) should be used and temperature monitored.

Due to the cardiovascular and respiratory depressant effects of most anesthetics, it may be necessary to support cardiac and ventilatory function. In the first instance, anesthetic overdose should be assumed, and attempts made to decrease anesthetic administration. The need for assisted ventilation can be guided by capnography, and should be provided if the end-tidal carbon dioxide consistently exceeds 60 mmHg despite appropriate anesthetic depth. Even in situations where the animal is not intubated, supplemental oxygen should be provided to compensate for depressed ventilation.

Cardiovascular depression may manifest as bradycardia or arterial hypotension. Cut-off values for acceptable heart rate depend on the animal's preanesthetic values; however, in general, heart rate should be maintained above 100 beats/min in cats, and 60 beats/min in dogs. If the heart rate is consistently below these values and is not coupled with high arterial blood pressure, then treatment with an anticholinergic may be warranted (with appropriate caution taken if the bradycardia is related to administration of an α_2 agonist; see description of these agents later in this chapter). Mean arterial blood pressure values below 60 mmHg require attention to prevent renal damage. Devising a balanced anesthetic protocol that includes premedication and adequate analgesia will usually enable healthy animals to be anesthetized without administering high concentrations of anesthetic. Therefore, in most healthy animals, an acceptable mean arterial blood pressure will be achieved by maintaining a light anesthetic depth and provision of perioperative IV fluids. Increasing the rate of IV fluid infusion may be beneficial in the face of persistent hypotension. More aggressive treatment of persistent cardiovascular depression may require infusion of α - or β -adrenergic agonists, such as dopamine, dobutamine, or norepinephrine, if acceptable under the conditions of the study. Such therapies are usually only required in the presence of severe cardiovascular derangements such as those resulting from severe hemorrhage, cardiac failure, or sepsis. Where these are present, a means to support cardiovascular function should be incorporated into the initial study protocol, if survival at the end of the anesthetic period is intended.

IX. RECOVERY

The recovery period incorporates the time from cessation of anesthetic to tracheal extubation, and continues until the animal is sufficiently stable to be left unattended. Typically, as the animal recovers, there is a progressive return of palpebral reflex and jaw tone, increase in respiratory rate, uncoordinated motor efforts, and endotracheal tube intolerance. Nystagmus may be seen; however, this is less common in dogs and cats than in other species. Recovery from anesthesia may be associated with a period of excitement or dysphoria. Distinguishing this from postoperative pain is difficult, and therefore treatment with analgesics (such as hydromorphone 0.05 mg/kg or

buprenorphine 0.02 mg/kg) and low doses of sedatives (such as acepromazine 0.01–0.02 mg/kg or medetomidine 0.5–2 μ g/kg), given intravenously for rapid onset of action, is often indicated. Achieving a good quality of sedation from the premedication can help smooth the recovery period, although this may need to be repeated after long procedures.

In the absence of intraoperative complications (such as hemorrhage or hypothermia), resolution of anesthetic-depressed respiratory and hemodynamic function coincides with the stage of recovery when the animal will no longer tolerate the endotracheal tube (Polis et al., 2001). Attention to heart rate, respiratory rate, and mucous membrane color should therefore continue even after discontinuation of anesthetic, at least until recovery of swallowing and cough reflexes. Evaluation of mucous membrane color is particularly important after withdrawing supplemental oxygen, to ensure that the animal does not become cyanotic. Following long or complicated procedures, continued supplemental oxygen provision may be required into the postoperative period to prevent hypoxemia caused by residual respiratory depression. Depending on the agents used and duration of anesthesia, it may be several hours before recovery to sternal recumbency and standing is achieved. The animal does not necessarily require continuous monitoring once the endotracheal tube is removed and heart and respiratory rate have returned to preanesthetic values. However, occasional monitoring, the frequency of which is dictated by the duration and invasiveness of the procedure performed, should continue until the animal is able to stand, as sedation, cardiopulmonary depression, and decrease in temperature may recur. Hourly evaluation of heart rate, respiratory rate, mucous membrane color, and pain control are suggested for 2–6 hours following invasive procedures (e.g., thoracotomy, prolonged laparotomy, and craniotomy) or where hemorrhage is possible. Prolonged sedation, or cardiovascular or respiratory depression should also prompt assessment of body temperature; however, repeated measurements of rectal temperature are not required if the animal is otherwise recovering well, and frequent checking of body temperature may be distressing for the animal. After painful procedures, sufficiency of analgesia should continue to be frequently evaluated (decreasing gradually from hourly assessments to 2–3 times/day), particularly when changes in analgesic regimen are made, with the ability to administer additional analgesics if required.

X. ANALGESIA

Drugs used for analgesia include opioids, NSAIDs, and local anesthetics. Optimal analgesia is provided by combining drugs from different classes, a concept known as multimodal analgesia, that produces superior analgesia using lower drug doses than is achieved using a single agent. Providing adequate analgesia for surgical procedures involves the administration of analgesic

prior to, and continued for the duration of, the noxious stimulation (usually, and most conveniently, as part of the anesthetic premedication). Administering the analgesic prior to the onset of painful stimuli provides preemptive analgesia and is more successful than administration after the onset of pain (Penderis and Franklin, 2005). The choice of analgesia and duration of postoperative treatment vary according to the pain intensity of the procedure performed (extent of tissue trauma, amount of visceral handling, and incision length). The presence of preoperative pain and increased stress or anxiety also increase pain response (Kalkman et al., 2003). It is therefore essential to tailor the analgesic regimen to the procedure to be performed; however, because of interindividual variability in pain response, it is also necessary to include the provision of increasing analgesic dosing to animals with greater than anticipated postoperative pain.

Pain assessments should be performed frequently. Pain behavior differs greatly in dogs and cats, and it is important to be aware of the signs of postoperative discomfort. Familiarity with the normal preoperative behavior of individual dogs and cats is highly beneficial in pain assessment, and deviation from the animal's normal posture, behavior, or demeanor should provoke concern for the quality of pain management. Pain evaluation involves interacting with the animal, as responses to locomotion, handling and gentle wound palpation are extremely informative. In both species, the animal may adopt a hunched or otherwise abnormal posture if it is painful. Dogs may vocalize, particularly upon lesion palpation, while cats are more likely to become quiet and withdrawn, hiding in the rear of their housing. Lack of appetite, inability to lie down, and unwillingness to interact with a known handler may also indicate a painful state. Physiological parameters, such as heart rate, are frequently used to assess pain, but are relatively poor indicators when compared to behavioral and postural changes. Recognition of pain is described in more detail elsewhere in this text.

A. Opioids

Opioids provide the basis of surgical pain management. Because of their minimal adverse effects (predominantly respiratory depression, but this usually occurs at high doses or in the deeply anaesthetized animal, and is diminished in the presence of pain), they are an ideal component of the anesthetic protocol. Although vomiting may occur after the preanesthetic dose, subsequent postoperative doses elicit this response less frequently. Pure opioid agonists (morphine, hydromorphone, and methadone) provide the greatest level of analgesia; partial agonists (buprenorphine) should be reserved for less painful procedures, or used 1–2 days postoperatively when pain intensity has lessened. Partial agonists exhibit a ceiling effect to analgesic efficacy, and therefore there is an upper limit to the amount of analgesia that can be provided. In contrast, when using pure agonists, dose can be increased to provide additional analgesia if required. Butorphanol, an opioid

agonist–antagonist that acts only at the opioid kappa receptor, is useful in sedation combinations, but has largely been replaced by buprenorphine for analgesia for mild pain in dogs and cats. Compared to buprenorphine, butorphanol has a short duration of action and minimal efficacy. Guidelines for analgesic management using these agents are shown in Table 13-5.

In addition to intermittent parenteral administration, there are a number of alternate methods of dosing opioids. The use of transdermal drug delivery systems enables continued uptake of fentanyl or buprenorphine for a 3-day period after patch placement. There is a delay of up to 24 hours (in dogs) and 6–12 hours (in cats) after placement for onset of activity, and therefore either the patch should be placed the day prior to surgery, or alternate methods for analgesic management should be used during this time. Patches should not be cut or stapled, as this will lead to rapid and unpredictable drug release. If partial patches are required, a better alternative is to remove only half of the protective cover, thus leaving only half the patch in contact with the skin. Table 13-5 lists the recommendations for transdermal fentanyl patch sizes.

In addition to parenteral routes, injectable buprenorphine can be administered orally in cats, since it exhibits transbuccal absorption in this species. Bioavailability is 100%; therefore, the oral dose is the same as the parenteral dose (0.02 mg/kg), and the duration of action is also the same (up to 6 hours). As long as the pain intensity is not severe, buprenorphine is a useful drug for postoperative analgesia, due to the longer duration of action compared to pure opioid agonists (the longest-acting, e.g. morphine, only provide up to 4 hours of analgesia). Epidural administration of preservative-free morphine (0.1–0.2 mg/kg, in a volume of 0.1 ml/kg, diluted in sterile saline if necessary) produces an even longer duration of analgesia, with up to 18 hours efficacy after a single injection. Although demanding a greater level of skill than other routes of drug administration, this technique, described in Wetmore and Glowaski (2000), can be quickly learned and epidural injection is generally achievable in dogs and cats that are not overweight. The duration of analgesia provided is ideal where personnel availability limits the ability to perform 4–6 hourly analgesic injections. Attention should be paid to urination, as transient urinary retention is a possible side effect; however, this can be managed by expressing the bladder or passing a urinary catheter. Liposome-encapsulated opioids are emerging into veterinary medicine; these produce analgesia for several days after a single parenteral dose (Smith et al., 2003). When such medications become more widely available, they will be very useful for postoperative analgesia. Sustained release oral opioid formulations (see Table 13-5) are useful for animals awake enough to tolerate oral medications.

B. NSAIDs

NSAIDs can be used in combination with opioids, producing an excellent synergistic effect. There are many NSAIDs

TABLE 13-5
OPTIONS FOR ANALGESIA IN DOGS AND CATS

Drug(s)	Doses, comments
Morphine, methadone	0.2–0.5 mg/kg SQ/IV (not IV morphine)/IM every 4 hours Oral sustained release morphine tablets: 0.5 mg/kg/day
Hydromorphone, oxymorphone	0.05–0.1 mg/kg SQ/IV/IM every 4 hours For moderate to severe pain combine with additional analgesic type (e.g. local anesthetic, NSAID, ketamine)
Buprenorphine	0.02 mg/kg SQ/IV/IM every 6 hours. For mild-moderate pain, e.g. minimally invasive surgery, or >24–48 hours after laparotomy/thoracotomy
Transdermal fentanyl	Cats and dogs up to 10 kg: 25 µg/h patch Dogs 10–25 kg: 50 µg/h patch Dogs >25 kg: 2 × 50 µg/h patches (better than 100 µg/h patch) Patch takes 6–12 hours (cats), 24 hours (dogs) for maximal effect. Duration of analgesia = 3 days
Epidural analgesia	Preservative-free morphine: 0.1–0.2 mg/kg, diluted in sterile water or 0.9% saline to a volume of 0.1 ml/kg, injected into epidural space at lumbosacral junction. Provides 12–18 hours analgesia
NSAIDs	Excellent synergistic effect with opioids Carprofen (dogs) 4 mg/kg/day PO or IV Meloxicam (dogs) 0.3 mg/kg once PO or SQ. 0.1 mg/kg/day for >1 day use See text for recommendations in cats
Local anesthetics	Via chest tube (thoracotomy pain) or wound catheter: 1.5 mg/kg bupivacaine or ropivacaine every 8 hours Intraarticular: 0.1–0.2 ml/kg bupivacaine or ropivacaine at end of surgery
Ketamine	Excellent analgesia when combined with opioids +/- NSAIDs 10–20 µg/kg/min, combined with opioid analgesia Compatible with LRS For anesthesia maintenance IV fluid infusion rate (10 ml/kg/h), add 60–120 mg ketamine to 1 l LRS For postoperative maintenance fluid infusion (2 ml/kg/h), add 300–600 mg ketamine to 1 l LRS

Note: Doses are based on author's clinical use, and may differ from other published dose ranges.

available for use in dogs, including carprofen, meloxicam, ketoprofen, and etodolac, most of which require only 24-hourly dosing. Recommended doses are shown in Table 13-5. Care should be taken not to exceed the recommended dosing regimens, as adverse effects on renal, hepatic and gastrointestinal function may result. NSAIDs use is contraindicated in animals that are vomiting, anorexic, or have diarrhea, because of the increased risk of gastrointestinal ulceration and subsequent perforation. They are also contraindicated in animals that have undergone (or will undergo) a period of decreased tissue perfusion as a result of experimental protocol (e.g., vessel cross-clamping, induced hypovolemia). This is because blood supply to the liver, kidneys, and gastrointestinal tract will be compromised, which when combined with the toxic effects of NSAIDs on these organs, carries a significant risk of organ damage. The cyclooxygenase-2 (COX-2) specific inhibitors (deracoxib and firocoxib) theoretically have fewer adverse effects than traditional NSAIDs; however, practically this may not be the case, and monitoring for complications is still warranted. Cats are more prone to complications (usually nephrotoxicity) than dogs. However, meloxicam is commonly used in cats in clinical

practice; its liquid formulation for oral dosing facilitates accurate dosing for animals of low body weight (compared to splitting large dose tablets). Meloxicam, along with carprofen and ketoprofen, are available in an injectable formulation, which is useful for perioperative administration in both dogs and cats.

C. Local Anesthetics

Local anesthetic nerve blocks provide desensitization of a particular region for a period of up to 8 hours (if ropivacaine or bupivacaine are used). Not all surgical sites are conducive to nerve blocks; however, the digits, rostral mandible and maxilla, and distal forelimb can be desensitized using a ring block, mandibular, infraorbital, or brachial plexus block, respectively. The use of local anesthetics in chest drains (analgesia of the thorax and cranial abdomen) or intraarticular administration (e.g., after arthrotomy or arthroscopy) (Hoelzler et al., 2005) also provides effective analgesia, particularly when used as a component of a multimodal protocol (Table 13-5). Local anesthetics may be infused into fenestrated catheters (Diffusion

catheter™, MILA International, Kentucky) sutured into surgical wounds. This is particularly effective for analgesia of areas of extensive soft-tissue resection, e.g., amputations and skin flaps (Wolfe et al., 2006). Lidocaine is also available as a transdermal patch (Lidoderm™). However unlike fentanyl and buprenorphine patches, systemic absorption is minimal and the patch is designed to be placed directly over the painful area for a local effect. The patch is placed for 12-hourly on/off cycles. Anecdotally, such patches seem beneficial when placed immediately to the side of a surgical incision, to supplement opioid-based postoperative analgesia. Placement over painful joints (e.g., osteoarthritis) may also be effective.

D. Ketamine

Although not previously thought to be an effective analgesic, ketamine has been shown to increase the level of analgesia provided when used in combination with other analgesic agents (Robertson and Taylor, 2004; Wagner et al., 2002). It is not an effective analgesic when used alone, but as part of a multimodal analgesic combination, particularly with opioids, it is able to provide enhanced relief from both visceral and somatic sources of pain. When used as an analgesic, ketamine is typically administered as an infusion (see Table 13-5), during and after surgery, and since it is compatible with both 0.9% saline and LRS, can be added to the animal's intraoperative or postoperative maintenance fluids. However, even if incorporated into the anesthetic premedicant or induction protocol, and thus administered as a bolus IV or IM injection, it may provide some preemptive analgesia. It is particularly effective in complex pain states, such as surgical procedures in the presence of preexisting pain (e.g., multiple surgeries on the same animal, induced arthritis), nerve damage (e.g., nerve ligation, thermal or chemical burns), or extensive tissue damage.

XI. SPECIFIC CONSIDERATIONS

A. Breed Variability

In general, there is little breed variation in anesthetic response, and in most circumstances, there is only a small number of breeds used for laboratory purposes. However, a small number of breeds warrant particular mention, as they may be encountered occasionally. Greyhounds, lurchers, and similar breeds (collectively known as sighthounds) demonstrate prolonged recovery (greater than 8 hours) when exposed to thiobarbiturates (thiopental and thiamylal), due to alterations in drug redistribution and hepatic metabolism (Sams et al., 1985). With the exception of prolonged or terminal procedures, alternate anesthetic induction agents should therefore be used. Certain Boxer dogs demonstrate syncope, marked bradycardia, and hypotension when exposed to acepromazine—this does not

occur in all individuals, but is unpredictable; therefore, it is recommended not to use this agent in this breed. Most other “breed sensitivities” relate to disease states that are overrepresented in a given breed (e.g., hypertrophic cardiomyopathy in Maine Coon cats), and are not significant if the animal does not exhibit such abnormalities. Brachycephalic breeds (typified by English Bulldogs, Pugs, etc.) may develop severe respiratory obstruction during the perianesthetic period if the airway is not secured (and particularly immediately after tracheal extubation); however, individuals within these breeds that are not markedly brachycephalic will be minimally affected. Inherited clotting factor deficiencies, such as Von Willebrand's deficiency in Doberman Pinschers and factor VII deficiency in Beagles, may result in profound increases in surgical bleeding, and should therefore be considered in susceptible populations.

B. Craniotomy and Intracranial Lesions

During procedures where elevated ICP is a concern, such as the presence of cerebral edema or hemorrhage, it may be necessary to select an anesthetic protocol that minimizes elevations in ICP or protects against periods of cerebral ischemia. In the healthy brain, matching of cerebral blood flow to neuronal activity is effectively controlled by autoregulation. However, in the presence of lesions such as surgical trauma, hemorrhage, hydrocephalus, or edema, autoregulation is impaired and blood supply is dependent on a balance between systemic blood pressure and ICP. Elevations in ICP may result from hypercapnia, jugular venous occlusion, coughing on intubation (caused by insufficient anesthetic depth), and use of ketamine. Agents that markedly decrease cardiac output may also impair cerebral blood flow, and include acepromazine, α_2 agonists, and large doses of most volatile and injectable anesthetic agents. Opioids are not contraindicated in intracranial disease, as long as the animal is monitored and treated for hypoventilation. Either volatile agents or TIVA may be used for maintenance of general anesthesia, as long as cardiovascular and respiratory functions are supported and steps are taken to use the minimum dose (no greater than 1–1.5 MAC for the volatile agents is recommended for maintenance of cerebral autoregulation). Thiopental may offer some protection from cerebral ischemia, and is the author's preferred induction agent for clinical cases of seizures or elevated ICP.

C. Thoracotomy

Any of the anesthetic protocols described earlier in the chapter are suitable for routine thoracotomy; however, nitrous oxide should not be included due to the risk of postoperative pneumothorax. Thoracic surgery is generally classified as one of the procedures causing severe postoperative pain. The presence of such pain, in addition to causing distress and suffering, will impair breathing, leading to hypoventilation, hypoxemia, and

increased risk of postoperative pneumonia. Pure opioid agonists are required for the management of thoracotomy pain for the first 24–48 hours postoperatively. However, since high doses of these agents may also depress ventilation, respiratory rate should be monitored, at least in the initial postoperative period. Analgesics such as ketamine, NSAIDs, and local anesthetics (intercostal nerve block perioperatively, and via the chest tube postoperatively), which do not depress ventilation, are very useful additions to an opioid-based analgesic plan, reducing the opioid dose required to allow effective management of pain. Administration of opioids via epidural injection is also useful and has fewer respiratory side effects. Animals that are undergoing thoracotomy in a clinical setting frequently have underlying pulmonary or pleural space disease, and may require oxygen supplementation and drainage of pleural contents (air, effusion) prior to anesthetic induction. This is not usually the case for laboratory animals; however, these precautionary procedures should be carried out if indicated.

Positive pressure ventilation is necessary for animals undergoing thoracotomy. Ventilator settings may require alteration after opening the thorax, due to a change in respiratory compliance, particularly if a pressure-cycled ventilator is used. To maintain normocapnia and adequate oxygenation, mechanical ventilation should ideally be guided by capnometry and pulse oximetry, with arterial blood gas analysis being helpful for more complicated procedures (e.g., prolonged surgeries, extensive lung resection). Very few animals require neuromuscular blockade for mechanical ventilation, and if the animal is “bucking” or fighting the ventilator, an excessively light plane of anesthesia, inadequate analgesia, or ineffective ventilator settings should be assumed and corrected. Ventilatory management can be particularly challenging in thoracoscopic procedures, where pleural insufflation leads to lung collapse, or those involving one-lung ventilation, in which marked ventilation–perfusion mismatch can occur. All volatile anesthetics impair hypoxic pulmonary vasoconstriction; however, this phenomenon also occurs when an injectable technique is used (albeit to a lesser extent). At the end of the procedure, particular attention should be paid to respiratory function during the recovery period, as residual anesthetic effects may cause hypoventilation, leading to hypercapnia and cyanosis.

D. Cardiovascular Conditions

There are many examples of situations where anesthesia of animals with cardiovascular compromise is required (e.g., induced hypovolemia or sepsis) or where a cardiovascular-sparing protocol is needed (e.g., for measurements of cardiovascular parameters). Anesthetic agents that have minimal effects on cardiovascular function include the opioids, benzodiazepines, alphaxalone, and etomidate. Ketamine typically does not depress the cardiovascular system, although mild tachycardia may occur. This agent is generally suitable for animals with

mild-to-moderate cardiovascular compromise, but it should not be used in cats with hypertrophic cardiomyopathy. Maintenance of general anesthesia with minimal interference with cardiovascular function can be achieved using low concentrations (<MAC) of volatile agents, supplemented with infusion of an opioid, such as fentanyl (0.1–0.7 $\mu\text{g}/\text{kg}/\text{min}$). High doses of opioids may decrease cardiac output by causing bradycardia; however, this can be overcome by administering an anticholinergic agent.

E. Orthopedic Conditions

Anesthesia for orthopedic procedures is typified by minimal physiological derangements, and therefore many anesthetic management strategies are suitable. It is important to carefully consider analgesic management for such patients, whether for surgically induced conditions (such as osteotomy, arthrodesis) or chemically induced arthritis. NSAIDs provide excellent analgesia for orthopedic pain, especially when combined with opioid agonists. There is much literature available regarding the effects of the NSAIDs on bone and cartilage healing, with contradiction between various reports. In clinical veterinary medicine, this is not perceived as a significant problem, and many dogs and cats with long bone fractures receive NSAIDs as part of their perioperative and postoperative analgesia regimen, without repercussions of nonunions or delayed healing. Microscopic evidence of altered healing is reported with NSAID use, particularly in experimental and rodent models; however, the clinical relevance of this is questionable. It is important to note that the dramatic synergy between the analgesic effects of NSAIDs and opioids implies that if an NSAID is not administered, e.g., because microscopic evaluation of bone or cartilage repair is integral to the study, much higher doses of opioids will be required. Doses exceeding those listed in Table 13-5 will frequently be needed for adequate pain control.

The anatomical location of many orthopedic lesions means that local and regional anesthetic techniques can frequently be employed to enhance analgesia. Analgesia for hindlimb procedures can be provided by epidural administration of opioids and/or local anesthetics, whereas forelimb analgesia, particularly of structures distal to the elbow, can be provided using a brachial plexus nerve block. Analgesia for arthrotomy can be enhanced by the use of intraarticular local anesthetics. Descriptions of the techniques for these nerve blocks and epidural drug injections can be found in Skarda (1996) and Wetmore and Glowaski (2000). Unless catheters are placed for continuous drug administration, the duration of analgesia provided by local nerve blocks (6–8 hours using ropivacaine or bupivacaine) is limited, and therefore these should not provide the sole means of analgesia. Instead, these techniques are particularly useful when performed prior to surgery, providing excellent preemptive analgesia. Systemic opioids and NSAIDs should then be continued into the postoperative period. Assessment of adequacy of pain

relief can be easily performed when only one limb is affected, as untreated pain will result in decreased use of the leg, and gait asymmetry.

F. Cesarean Section

The aims of anesthesia for cesarean section are to minimize depression of the neonates, and enable a rapid anesthetic recovery such that the dam can quickly nurse the kittens/puppies. Analgesia is complicated by a desire to avoid sedation and respiratory depression in the neonates; epidural administration of morphine (Table 13-5) is an excellent solution and avoids placental transfer of drugs. Rapid-acting anesthetic agents are recommended; an example of a suitable anesthetic protocol is IV midazolam (0.2 mg/kg) followed by propofol, dosed to permit endotracheal intubation, and sevoflurane or desflurane for maintenance of general anesthesia. Epidural morphine injection can be performed immediately after anesthetic induction; alternatively, buprenorphine (0.02 mg/kg) can be administered immediately after the neonates have been delivered. This is the less satisfactory of the two analgesic protocols, due to the absence of provision of preemptive analgesia. The use of NSAIDs is not recommended, as these readily transfer across the placenta and into the milk, and are not suitable for neonates.

G. Neonatal Anesthesia

Dogs and cats may be regarded as neonates for up to 1 month after birth, although susceptibility to hypothermia and hypoglycemia persists for longer periods (particularly in small breeds). Fasting is poorly tolerated, and therefore food should be withheld for only short periods (2–4 hours) prior to general anesthesia. Hepatic and renal function is decreased compared to the adult, resulting in alterations in drug metabolism (increasing both magnitude and duration of effect) and susceptibility to hypoglycemia. Pharmacokinetics of many drugs are altered; owing to the altered distribution of cardiac output, low plasma protein level, and changes in metabolism, the responses to individual drugs can be difficult to predict. It is therefore recommended to initially use low doses of drugs, administered incrementally to achieve the desired effect, and to select short-acting or reversible agents. Suitable options include benzodiazepines, opioids, propofol, and volatile anesthetics. Hypovolemia is poorly tolerated, as mechanisms to regulate fluid balance are impaired, and rapid administration of IV fluids to correct hypovolemia is more likely to result in edema than restoration of effective circulating fluid volume. Cardiac output and systemic blood pressure are heavily dependent on heart rate, rather than increases in cardiac contractility and systemic vascular resistance, and therefore bradycardia should be promptly treated by decreasing anesthetic depth and administration of anticholinergic agents. Due to a large surface-area-to-volume ratio, minimal fat deposits, and impaired thermoregulatory

mechanisms, hypothermia occurs frequently in the anesthetized neonate, and therefore rigorous support of body temperature should begin immediately after anesthetic induction.

H. Prolonged Anesthesia

In certain procedures, there may be a requirement to maintain general anesthesia for long periods (>24 hours). When this occurs, whether or not recovery from anesthesia is anticipated is an important factor in determining the anesthetic plan. For many prolonged procedures, infusions of pentobarbital (5 mg/kg/h) or thiopental (5–10 mg/kg/h) provides a stable plane of anesthesia; however, due to drug accumulation, dose requirements will decrease with time and recovery will be very prolonged after termination of drug administration. If the animal is to recover from anesthesia, analgesia must be incorporated into the anesthetic protocol for painful procedures; opioids such as morphine (50–200 µg/kg/h), hydromorphone (25 µg/kg/h), or fentanyl (5–25 µg/kg/h) may be given by infusion, which help to decrease the required dose of the anesthetic agent. For prolonged anesthesia where eventual recovery is anticipated, propofol frequently provides the basis of the anesthetic technique. Depending on the administration of other agents, propofol is administered at the rate of 0.1–0.4 mg/kg/h, with a possible tolerance developing over several days. The coadministration of midazolam (0.35 µg/kg/min), ketamine (10–20 µg/kg/min), lidocaine (50 µg/kg/min), or an opioid (see above) helps to decrease the dose of propofol required. In healthy animals, all these anesthetic protocols are generally tolerated for long periods, as long as basic cardiovascular and respiratory monitoring and support (e.g., supplemental oxygen, assisted ventilation) is provided. Prolonged propofol administration results in hypertriglyceridemia (Gronert et al., 1998); however, pancreatitis has not been reported as a complication in either dogs or cats. For anesthetic procedures lasting longer than 24 hours, nutritional support is important. As with shorter procedures, ongoing monitoring of anesthetic depth (to guide changing dose requirements over time) and physiological parameters is required.

I. Considerations for Cats

For most anesthetic agents, the doses provided and adverse effects expected are the same in both dogs and cats. However, cats have a number of metabolic and physiological differences compared to dogs, which are relevant to anesthetic management. Cats have reduced hepatic glucuronidation capacity, and therefore metabolism of drugs may be delayed and effects prolonged. This is particularly important when injectable anesthetics are administered in repeated doses or by continuous infusion, when the lower end of the provided dose range should be selected. It is particularly apparent for propofol, the repeated administration of which has important consequences in cats (see earlier propofol discussion). The difference in hepatic metabolism also has

consequences for dosing of NSAIDs in cats, particularly when more than one dose is required; when NSAIDs are required for more than one day, a reduction in dose and prolongation of dosing interval is usually employed. For example, for chronic dosing of meloxicam in cats, the author recommends 0.1 mg/kg for 3 days, decreasing to 0.1 mg/kg every other day for 3 doses, and then 0.05 mg/kg every other day for ongoing treatment. In contrast to dogs, where gastrointestinal disorder is often the first sign of NSAID toxicity, cats more typically demonstrate azotemia, and therefore periodic measurement of serum urea and creatinine is warranted for chronic (> 1 month) NSAID use.

In contrast to these examples, some agents are dosed higher in cats than in dogs. Cats may require higher doses of sedatives (notably acepromazine and medetomidine) than dogs, and this is reflected in the dosing recommendations provided in Table 13-2. Adverse effects also vary between the species; with the volatile anesthetic agents, cats appear to exhibit greater cardiovascular depression than seen in dogs at equivalent anesthetic depth, and therefore, cats may require more rigorous support of blood pressure and close titration of anesthetic dose. Reports of the use of pure-agonist opioids in cats are somewhat conflicting, with excitement and mania being frequently reported (Robertson and Taylor, 2004). While buprenorphine can generally be administered to cats without these side-effects, the dysphoric effects of the pure agonists can usually be controlled using acepromazine (0.02–0.05 mg/kg), enabling a pure-agonist agent to be used. Lastly, cardiovascular toxicity of lidocaine is also increased in cats. IV lidocaine injection is not recommended in this species, unless necessary to control ventricular arrhythmias, or for propofol-associated pain, when a reduced dose is given.

Other differences between anesthetic management of cats and dogs arise because of differences in body size and behavior. Because of their small size, cats are more prone to intraoperative hypothermia than dogs, which often manifests as a prolonged anesthetic recovery. Strategies to minimize heat loss should therefore be employed. Management of pain is complicated by the difficulty of pain assessment in this species. The response to pain in cats is typically to become quiet, remain still, and hide; hence, it can be challenging to determine whether or not a cat is in pain. It is therefore important to administer analgesic doses to cats on the basis of the likely intensity of pain, guided by the nature of the procedure, and not solely on the basis of the behavior shown.

SUGGESTED ADDITIONAL READING

- Heavner, J.E. (2001). Anesthesia update: Agents, definitions, and strategies. *Comp. Med.* **51**(6), 500–503.
- Pascoe, P.J. (2000). Perioperative pain management. *Vet. Clin. North Am. Small Anim. Pract.* **30**(4), 917–932.
- Wagner, A.E., Wright, B.D., and Hellyer, P.W. (2003). Myths and misconceptions in small animal anesthesia. *J. Am. Vet. Med. Assoc.* **223**(10), 1426–1432.

REFERENCES

- Alibhai, H.I., Clarke, K.W., Lee, Y.H., and Thompson, J. (1996). Cardiopulmonary effects of combinations of medetomidine hydrochloride and atropine sulphate in dogs. *Vet. Rec.* **138**(1), 11–13.
- Autefage, A., Fayolle, P., and Toutain, P.L. (1990). Distribution of material injected intramuscularly in dogs. *Am. J. Vet. Res.* **51**, 901–904.
- Barter, L.S., Ilkiw, J.E., Steffey, E.P., Pypendop, B.H., and Imai, A. (2004). Animal dependence of inhaled anaesthetic requirements in cats. *Br. J. Anaesth.* **92**(2), 275–277.
- Bellah, J.R., Robertson, S.A., Buergelt, C.D., and McGavin, A.D. (1989). Suspected malignant hyperthermia after halothane anesthesia in a cat. *Vet. Surg.* **18**(6), 483–488.
- Brodgelt, D., Brearley, J., Young, L., Wood, J., and Pfeiffer, D. (2005). Anaesthetic-related mortality risks in small animals in the UK. *Vet. Anaesth. Analg.* **32**(6), 1–2.
- Dodam, J.R., Kruse-Elliott, K.T., Aucon, D.P., and Swanson, C.R. (1990). Duration of etomidate-induced adrenocortical suppression during surgery in dogs. *Am. J. Vet. Res.* **51**(5), 786–788.
- Greene, S.A., Benson, G.J., Tranquilli, W.J., and Grimm, K.A. (2002). Relationship of canine bispectral index to multiples of sevoflurane minimum alveolar concentration, using patch or subdermal electrodes. *Comp. Med.* **52**(5), 424–428.
- Gronert, G.A., Haskins, S.C., Steffey, E.P., and Fung, D. (1998). Plasma electrolyte and metabolite concentrations associated with pentobarbital or pentobarbital-propofol anesthesia during three weeks' mechanical ventilation and intensive care in dogs. *Lab. Anim. Sci.* **48**(5), 513–519.
- Hall, L.W., and Clarke, K.W. (1991). Principles of sedation, analgesia and premedication. In "Veterinary Anaesthesia," 9th ed., pp 51–64. W.B. Saunders, London.
- Hans, P., Dewandre, P.Y., Brichant, J.F., and Bonhomme, V. (2005). Comparative effects of ketamine on bispectral index and spectral entropy of the electroencephalogram under sevoflurane anesthesia. *Br. J. Anaesth.* **94**(3), 336–340.
- Haskins, S.C., and Knapp, R.G. (1982). Effect of low carrier gas flows (50% oxygen/50% nitrous oxide) on inspired oxygen tension in anesthetized dogs. *J. Am. Vet. Med. Assoc.* **180**(7), 735–738.
- Hatch, R.C., Jernigan, A.D., Wilson, R.C., Lipham, L.B., Booth, N.H., Clark, J.D., and Brown, J. (1986). Prompt arousal from fentanyl-droperidol-pentobarbital anesthesia in dogs: A preliminary study. *Can. J. Vet. Res.* **50**(2), 251–258.
- Heard, D.J., Webb, A.I., and Daniels, R.T. (1986). Effect of acepromazine on the anesthetic requirement of halothane in the dog. *Am. J. Vet. Res.* **47**(10), 2113–2115.
- Heldmann, E., Brown, D.C., and Schofer, F. (1999). The association of propofol usage with postoperative wound infection rate in clean wounds: A retrospective study. *Vet. Surg.* **28**(4), 256–259.
- Hoelzler, M.G., Harvey, R.C., Lidbetter, D.A., and Millis, D.L. (2005). Comparison of perioperative analgesic protocols for dogs undergoing tibial plateau leveling osteotomy. *Vet. Surg.* **34**(4), 337–344.
- Hsu, W.H. (1985). Xylazine-pentobarbital anesthesia in dogs and its antagonism by yohimbine. *Am. J. Vet. Res.* **46**(4), 852–855.
- Johnston, G.M., Taylor, P.M., Holmes, M.A., and Wood, J.L. (1995). Confidential enquiry of perioperative equine fatalities (CEPEF-1): Preliminary results. *Equine Vet. J.* **27**(3), 193–200.
- Kalkman, C.J., Visser, K., Moen, J., Bonsel, G.J., Grobbee, D.E., and Moons, K.G.M. (2003). Preoperative prediction of severe postoperative pain. *Pain* **105**(3), 415–423.
- March, P.A., and Muir, W.W. (2003). Use of the bispectral index as a monitor of anesthetic depth in cats anesthetized with isoflurane. *Am. J. Vet. Res.* **64**(12), 1534–1541.
- Matthews, N.S., Brown, R.M., Barling, K.S., Lovering, S.L., and Herrig, B.W. (2004). Repetitive propofol administration in dogs and cats. *J. Am. Anim. Hosp. Assoc.* **40**(4), 255–260.

- Mitchell, S.L., McCarthy, R., Rudloff, E., and Pernell, R.T. (2000). Tracheal rupture associated with intubation in cats: 20 Cases (1996–1998). *J. Am. Vet. Med. Assoc.* **216**(10), 1592–1595.
- Moon, P.F. (1997). Cortisol suppression in cats after induction of anesthesia with etomidate, compared with ketamine–diazepam combination. *Am. J. Vet. Res.* **58**(8), 868–871.
- Nelson, T.E. (1991). Malignant hyperthermia in dogs. *J. Am. Vet. Med. Assoc.* **198**(6), 989–994.
- Muir, W.W., and Wiese, A.J. (2004). Comparison of Lactated Ringer's Solution and physiologically balanced 6% hetastarch plasma expander for the treatment of hypotension induced via blood withdrawal in isoflurane-anesthetized dogs. *Am. J. Vet. Res.* **65**(9), 1189–1194.
- Newby, D.M., and Edbrooke, D.L. (1983). Influence of sedation on mortality in trauma patients. *Lancet* **1**(8338), 1381.
- Pascoe, P.J., Ilkiw, J.E., and Frischmeyer, K.J. (2006). The effect of the duration of propofol administration on recovery from anesthesia in cats. *Vet. Anaesth. Analg.* **33**(1), 2–7.
- Penderis, J., and Franklin, R.J. (2005). Effects of pre- versus post-anaesthetic buprenorphine on propofol-anaesthetized rate. *Vet. Anaesth. Analg.* **32**(5), 256–260.
- Polis, I., Gasthuys, F., Van Ham, L., and Laevens, H. (2001). Recovery times and evaluation of clinical hemodynamic parameters of sevoflurane, isoflurane and halothane anaesthesia in mongrel dogs. *J. Vet. Med.* **48**(7), 401–411.
- Robertson, S.A., and Taylor, P.M. (2004). Pain management in cats—past, present and future. Part 2. Treatment of pain—Clinical pharmacology. *J. Feline Med. Surg.* **6**(5), 321–333.
- Roizen, M.F. (2005). Preoperative evaluation. In “Anesthesia.” (R.D. Miller, ed.), 6th ed., pp 927–997. Churchill Livingstone, Philadelphia, PA.
- Sams, R.A., Muir, W.W., Detra, R.L., and Robinson, E.P. (1985). Comparative pharmacokinetics and anesthetic effects of methohexital, pentobarbital, thiamylal, and thiopental in Greyhound dogs and non-Greyhound, mixed-breed dogs. *Am. J. Vet. Res.* **46**(8), 1677–1683.
- Skarda, R.T. (1996). Local and regional anesthetic and analgesic techniques: Dogs. In “Lumb and Jones' Veterinary Anesthesia.” (J.C. Thurmon, W.J. Tranquilli, and G.J. Benson, eds.), 3rd ed., pp 426–447. Lipincott Williams and Wilkins, Pennsylvania, PA.
- Smith, L.J., Krugner-Higby, L., Clark, M., Wendland, A., and Heath, T.D. (2003). A single dose of liposome-encapsulated oxymorphone or morphine provides long-term analgesia in an animal model of neuropathic pain. *Comp. Med.* **53**(3), 280–287.
- Wagner, A.E., Walton, J.A., Hellyer, P.W., Gaynor, J.S., and Mama, K.R. (2002). Use of low doses of ketamine administered by constant rate infusion as an adjunct for postoperative analgesia in dogs. *J. Am. Vet. Med. Assoc.* **221**(1), 72–75.
- Wetmore, L.A., and Glowaski, M.M. (2000). Epidural analgesia in veterinary critical care. *Clin. Tech. Small Anim. Pract.* **15**(3), 177–188.
- Wolfe, T.M., Bateman, S.W., Cole, L.K., and Smeak, D.D. (2006). Evaluation of a local anesthetic delivery system for the postoperative analgesic management of canine total ear canal ablation—a randomized, controlled, double-blinded study. *Vet. Anaesth. Analg.* **33**(5), 328–339.

Chapter 14

Anesthesia and Analgesia of Ruminants

Alexander Valverde and Thomas J. Doherty

I. Introduction	386
II. Physiological and Anatomical Considerations	386
A. Size	386
B. Digestive System	386
C. Respiratory System	387
D. Cardiovascular System	389
E. Musculoskeletal System	389
III. Premedication	389
A. Restraint	389
B. Drug Administration	390
C. Sedation and Premedication	390
IV. Induction	395
A. Recommendations for General Anesthesia	395
B. Induction of Anesthesia in Small Ruminants and Calves	395
C. Induction of Anesthesia in Adult Cattle	397
D. Remote Capture of Ruminants	398
V. General Anesthesia	398
A. Anesthetic Equipment	398
B. Endotracheal Intubation	398
C. Intubation of Small Ruminants and Calves	398
D. Intubation of Adult Cattle	399
E. Maintenance of Anesthesia	400
F. Recovery from Anesthesia	401
VI. Local and Regional Anesthesia	401
A. Local Anesthetics	401
B. Epidural and Spinal Anesthesia	401
C. Technique of Epidural Injections in Small Ruminants and Calves	402
D. Paravertebral Anesthesia	402
E. Nerve Blocks of the Eye and Adnexa	403
F. Intravenous Regional Anesthesia (Bier's Block)	404
VII. Anesthesia for Husbandry Procedures	404
A. Dehorning and Disbudding	404
B. Castration	405
VIII. Monitoring the Anesthetized Patient	405
A. Depth of Anesthesia	405
B. Cardiovascular Function	406
C. Respiratory Function	406

D. Anesthetic Agent Concentration	406
E. Body Temperature	407
IX. Intraoperative Support	407
A. Fluid Administration	407
B. Support of Ventilation	407
C. Treatment of Intraoperative Hypotension	407
X. Analgesia	407
A. Alpha ₂ Agonists	407
B. Ketamine	408
C. Opioids	408
D. Lidocaine	408
E. Nonsteroidal Anti-Inflammatory Drugs	408
References	408

I. INTRODUCTION

Ruminants are commonly used in research as models related to human and veterinary studies. Cardiovascular, pulmonary, orthopedic, and pharmacokinetic models often use small ruminants as the species of choice due to similarities to humans and the convenience of size and ease of handling of these species. Examples include the use of sheep and goats for in vivo and in vitro studies of cardiac models for treatment of pulmonary embolism, cardioversion, effects of cardiac drugs, heart valve replacement, models of pharmacokinetics of corticosteroids in the sheep fetus, and models for joint and bone healing among others (Aydin et al., 2006; de Haan et al., 2006; Kandel et al., 2006; Schmitz-Rode et al., 2006; Schwab et al., 2006; Simsek et al., 2001; Timek et al., 2006; Viateau et al., 2006).

II. PHYSIOLOGICAL AND ANATOMICAL CONSIDERATIONS

A. Size

The size of small ruminants may be advantageous to some studies and facilitate handling and modeling aspects of human research. Small animal anesthetic circuits are appropriate for delivery of inhalation anesthetics in small ruminants. Conversely, the size and behavior of large ruminants (adult cattle) should be considered when planning studies that require general anesthesia due to the need for facilities and equipment to provide adequate methods of restraint.

B. Digestive System

Saliva production is high in small ruminants and cattle. Sheep can produce 6–16 L/day, whereas cattle have a daily output of 60–160 L (Leek, 1993). Most of the saliva is produced by the parotid salivary glands, primarily during feeding and rumination. The submaxillary glands produce less saliva (about one-eighth of the amount secreted by the parotid glands)

and are active during mastication of food but not rumination, since they contribute mainly to moistening and lubrication of food and less so to buffering of the stomach acidity (Kay, 1960). The submaxillary saliva is mucous and slightly cloudy, whereas the parotid saliva is fluid and clear (Kay, 1960). Parotid saliva is isotonic with plasma but contains higher concentrations of K⁺ (13 mmol/L), HCO₃⁻ (112 mmol/L), HPO₄²⁻ (48 mmol/L), and Na⁺ (170 mmol/L), and lower concentrations of Cl⁻ (11 mmol/L). Submaxillary saliva has lower concentrations of HCO₃⁻ (9 mmol/L), HPO₄²⁻ (5 mmol/L), and Na⁺ (9 mmol/L), and similar concentrations of K⁺ and Cl⁻ than parotid saliva (Kay, 1960). The pH of saliva is highly alkaline (pH 8.1) and helps to maintain a higher pH in the rumen (pH 5.5–7.0) than in the abomasum (pH 3) (Leek, 1993).

The effects of anesthesia on saliva secretion are not well known, especially if the stimulatory effect of active-induced secretion during feeding is absent during anesthesia. However, clinical observation indicates that saliva production is excessive in anesthetized ruminants compared to other species, and for this reason the airway should always be protected with a cuffed endotracheal tube. In one study, submaxillary production was similar in conscious and anesthetized sheep, although the composition of the saliva was different in both states (Kay, 1960). It is also not known how the proportional contribution of the different salivary glands to total saliva production is affected during anesthesia. Similarly, the saliva produced during general anesthesia is generally fluid and mucous in nature. The accumulation of saliva in the pharynx may cause a problem following extubation if accumulated saliva is not removed prior to extubation either by (1) lowering the head or (2) by suctioning the saliva from the pharynx. Administration of anticholinergics drugs (e.g., atropine and glycopyrrolate) to decrease salivation is not indicated. Anticholinergics may adversely affect gastrointestinal motility and, although the volume of saliva may be decreased, the water content of saliva is decreased making it more viscous and more difficult to clear from the airway.

The ruminant stomach (ruminoreticulum, abomasum, and omasum) represents 49% of the wet tissue mass of the total gastrointestinal tract in adult sheep and only 22% in the newborn. The ruminant stomach holds approximately 115–150 L in

adult cattle and 15–18 L in sheep and goats (Habel, 1975), representing approximately 25–35% of the total body mass. Ruminal activity is usually complete after 8 weeks of age if the animal has been ingesting progressively larger amounts of roughage before this age to initiate salivary gland and ruminoreticular development (Leek, 1993). At around 8 weeks of age, the proportionate sizes of the ruminoreticulum, abomasum, and omasum are similar to those of the adult animal, representing 69, 23, and 8% for the ruminoreticulum, abomasum, and omasum, respectively, of the total gastrointestinal tract (Leek, 1993).

The rumen contains a large quantity of ingesta and produces a large volume of gas through the process of fermentation. Materials in the rumen become partitioned into three primary zones based on their specific gravity. The upper portion is the gas layer, while grain and fluid-saturated roughage sink to the bottom of the rumen and freshly ingested roughage float in the middle layer. The rate of flow of solid material through the rumen is quite slow and dependent on size and density. Water flows rapidly through the rumen and seems to have a critical role in flushing out particulate matter.

Fermentation in the rumen produces up to 40 L/h of CO₂ and methane (CH₄) gas within 2–4 hours after a meal in adult cattle and up to 5 L/h in sheep and goats. These gases are eliminated through eructation at intervals of 1–2 minutes (Leek, 1993), a process linked to ruminal contractions. Eructated gases pass up the esophagus and much of it is inspired into the lungs and later expired. This expiration of ruminal gases can lead to errors in the measurement of inhalation anesthetics (see Section VIII, D.). Methane is not absorbed across the ruminal wall. Bloat or tympany is the result of ruminoreticulum distention by accumulated gas that cannot be eructated. Heavy sedation and general anesthesia inhibit ruminoreticular motility and impair eructation.

Regurgitation is part of rumination and is an active process to return the cud from the ruminoreticulum to the oral cavity for further chewing. Anesthetic drugs in general have an inhibitory effect on rumination at sedative or anesthetic doses. Interestingly, drugs with alpha₂-adrenergic activity, such as epinephrine, norepinephrine, and dopamine, can enhance epithelial receptors in the rumen to initiate rumination (Leek, 1993). Xylazine has stimulatory effects on rumination; however, these stimulatory effects are overridden by its central alpha₂ inhibitory actions and rumination ceases. Local administration of xylazine into the celiac or left gastric arteries will avoid central inhibition and stimulate rumination (Leek, 1993).

During anesthesia, ruminoreticular contents can flow toward the oral cavity due to loss of sphincter control from the cardia and caudal esophageal sphincters. This type of regurgitation is observed during superficial and deep planes of anesthesia (Dunlop and Hoyt, 1997; Steffey, 1986). An incomplete plane of anesthesia, especially while attempting intubation that results in stimulation of the larynx and a cough reflex, can provoke an explosive discharge of ruminoreticular contents giving the impression of a reflex process analogous to vomiting. However,

ruminants are not considered to be capable of true vomiting. In the authors' experience, active regurgitation is most likely to occur in the presence of ruminal stasis resulting in a buildup of ruminal fluid prior to surgery. Enormous volumes (>50 L) of fluid can build up in the rumen during rumen stasis, and the rapid exit of large volumes of fluid certainly gives the impression that this is an active process. Cattle with ruminal atony and a distended fluid-filled rumen are obviously poor subjects for anesthesia. Conversely, passive discharge of the ruminoreticular contents through relaxed sphincters occurs during a deep plane of anesthesia (Dunlop and Hoyt, 1997; Steffey, 1986).

Due to the large volume of ruminal contents, regurgitation must be managed in the anesthetized ruminant. Regurgitation may occur with the animal in any position but is more likely to occur in dorsal. Regurgitation per se is not the problem but rather the ensuing entry of ruminal contents into the airway.

The significant size and weight of the gastrointestinal tract may pose complications to the cardiovascular and respiratory systems during general anesthesia, due to compression of major vessels and displacement of the diaphragm into the thoracic cavity during recumbency. These events interfere with venous return and lung expansion, predisposing to low cardiac output, low blood pressure, low arterial oxygen partial pressures (PaO₂), and high arterial carbon dioxide partial pressure (PaCO₂). Therefore, reducing the weight of the gastrointestinal tract by fasting the animal before anesthesia ameliorates the negative effects on cardiorespiratory function. Withholding food for up to 48 hours has been recommended in adult cattle (Blaze et al., 1988) and up to 24 hours in small ruminants and calves capable of rumination (Dunlop and Hoyt, 1997).

Fasting the animal reduces the volume of ruminal contents, but the rumen never completely empties. Excessive fasting results in a reduction of ruminal flora due to the decrease in substrate and this leads to ruminal hypomotility and ketosis in some cases. Reducing the water intake prior to anesthesia is equally as important as reducing food intake, because continued water intake in this circumstance results in a relative increase in the liquid contents of the rumen and predisposes to regurgitation. The young ruminant (4–6 weeks) is essentially a monogastric as it exists primarily on milk or a milk substitute and has not yet transitioned to rumination. Generally, milk or milk substitute is only fed twice daily and should not be withheld prior to anesthesia. Anesthesia should be planned so that the calf ingests a liquid meal approximately 2 hours beforehand.

C. Respiratory System

In general, ruminants of the Bovidae family, but not other families of ruminants (including Cervidae, Camelidae, and Giraffidae), have significantly higher resting respiratory rates for their body mass than other mammals. This difference is attributed to the larger size of the rumen in the Bovidae family that exerts a respiratory load, which decreases lung compliance

TABLE 14-1

CARDIORESPIRATORY VALUES FOR CONSCIOUS RUMINANTS

Variable	Adult cattle	Calf	Sheep	Goat
Respiratory rate (breaths/min)	28	27–32	32–54	24–37
Tidal volume (ml/kg)	12	9	7	11
Heart rate (beats/min)	55–65	85–95	80–104	73–90
Cardiac index (ml/kg/min)	119	90–127	144	132
Systolic/diastolic, mean arterial blood pressure (mmHg)	155/105, 123	147/97, 116	125/96, 109	105/70, 86

Source: Abraham et al. (1981); Celly et al. (1997b); Ewaldsson et al. (2006); Gallivan et al. (1989); Haerdi-Landerer et al. (2005); Hikasa et al. (1998); Kästner et al. (2005); Lin et al. (1989); McGuirk et al. (1990); Mitchell et al. (1983); Mortola and Lanthier (2005); Olsson et al. (2001); Prassinis et al. (2005); Reinhold et al. (2002); Rioja et al. (2008); Skarda et al. (1982); Suzuki et al. (2005); Valverde et al. (1989).

and forces a rapid and shallow breathing pattern to produce an energetically efficient system (Mortola and Lanthier, 2005). In fact, tidal volumes for cattle, sheep, and goats have been demonstrated to be less than predicted values determined in other mammalian species that include nonruminants and other families of ruminants (Mortola and Lanthier, 2005) (Table 14-1). Because of this adaptation of Bovidae, the respiratory depressive effects of anesthetics may impose a more profound effect on blood gases than in other species, due to a decrease in respiratory rate and tidal volume.

Ruminants can represent a challenge for endotracheal intubation due to several factors: (1) sharp molar teeth and a narrow and long oral cavity can easily damage endotracheal tubes and make placement of laryngoscopes with wide blades difficult; (2) adult cattle are intubated blindly; and (3) in ruminants, the entrance to the laryngeal cavity is set obliquely and faces rostradorsally, which makes the angle of entry for the endotracheal tube more difficult than in other species (Fig. 14-1).

The right cranial lobe bronchus originates from the trachea at the level of the third rib and not from the mainstem bronchus as in other species. The tip of the endotracheal tube should not reach this point in the smaller ruminants to avoid one-lung ventilation and possibly collapse of the right cranial lobe.

Progressive hypercarbia is common in fasted and nonfasted ruminants and increases in magnitude over time, although the PaCO₂ is usually higher in nonfasted animals. The effect of fasting was investigated in halothane-anesthetized (1.14% end-tidal), spontaneously breathing cows in left lateral recumbency. One group was deprived of food for 48 hours and water for 12 hours, while the control group was not fasted and had access to water. Fasted cows had PaCO₂ values of approximately 67 mmHg at 60 minutes and 72 mmHg at 90 minutes, whereas nonfasted animals reached 75 mmHg at 60 minutes and

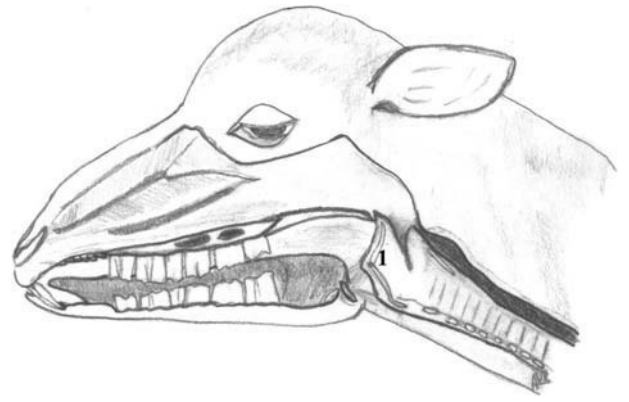

Fig. 14-1 Lateral view of head of sheep showing oral and nasal cavity. Note the rostradorsal positioning of the epiglottis (1), which hinders the entrance to the laryngeal cavity making orotracheal intubation difficult.

95 mmHg at 90 minutes (Blaze et al., 1988). PaO₂ for the two groups was 160 mmHg at 60 and 90 minutes for the fasted group, and 75 and 55 mmHg at 60 and 90 minutes, respectively, for the nonfasted group, despite administration of 100% O₂ (Blaze et al., 1988). Both groups of cows had similar minute ventilation (tidal volume × respiratory rate), which makes it likely that fewer differences due to ventilation/perfusion (V/Q) distribution were present in the fasted group (Blaze et al., 1988).

The reduction in lung volume caused by recumbency and the effects of the weight and bloating of abdominal contents on the diaphragm were thought to be responsible for the reduction in measured dynamic compliance of the lung and increased airway resistance that lead to the arterial blood gas differences between the two groups (Blaze et al., 1988). It is also probable that higher cardiac outputs were present in the fasted cows, although this parameter was not measured.

In this same study, fasted cows were shown to regurgitate more often and in larger volumes than nonfasted cows (Blaze et al., 1988). Although this may seem paradoxical, the greater fluid content in the rumen of fasted animals facilitates passive regurgitation during anesthesia and the lower ruminal content reduces the amount of bloat from fermentation.

Fasting also raises the ruminal pH to 8.0, which in addition to the fewer and smaller food particles from the reflux is less likely to cause pulmonary damage from aspiration (Steffey, 1986). Low gastric pH and large volumes determine the severity of aspiration pneumonitis in human anesthesia; therefore, the higher pH that results from fasting is beneficial. The larger reflux volumes observed in fasted animals can be drained by positioning the head slightly lower than the rest of the body, providing that a cuffed endotracheal tube has been placed to prevent leakage into the lungs.

Small ruminants may show less dramatic changes in the PaO₂ and less impact on V/Q abnormalities because of their size; however, PaCO₂ can increase markedly under general anesthesia with inhalants and this effect is dose-dependent.

Values above 100 mmHg have been observed in spontaneously breathing sheep maintained with inhalant anesthetics. It is also believed that goats are less affected than sheep. In one study, goats maintained with total intravenous anesthetic drugs (TIVA) that included ketamine and propofol or with inhalant anesthesia using sevoflurane (2.3% end-tidal) were able to maintain PaCO₂ at similar acceptable levels, between 45 mmHg and 47 mmHg (Larenza et al., 2005).

Nonrespiratory functions of the lung include defense mechanisms against blood-borne pathogenic agents by phagocytes attached to the pulmonary capillary endothelium, common in ruminants, pigs, and cats. These cells are known as pulmonary intravascular macrophages (PIMs) and are capable of trapping blood cells, bacteria, and particulates from circulating blood by endocytosis (Winkler, 1988). These functions of PIMs are served in other species, including dogs, humans, and laboratory animals, by very similar morphological cells known as Kupffer cells, found in the liver, spleen, and bone marrow (Winkler, 1998). The significance of the PIMs in regards to anesthesia obeys other functions of these cells, as they are capable of secreting prostaglandins and other inflammatory mediators, which regulate pulmonary hemodynamics under normal situations, but may result in drastic changes that lead to pulmonary hypertension, hypoxemia, and pulmonary edema. These alterations have been seen with transfusion reactions (Halmagyi et al., 1963) and in response to alpha₂-adrenergic anesthetics (Celly et al., 1999) in sheep and less frequently in other ruminants.

D. Cardiovascular System

Similar to other species, cardiovascular function is impaired in a dose-dependent fashion by anesthetics. Normal values for conscious ruminants are presented in Table 14-1.

As previously noted, size also plays a role in recumbent animals, as the weight of viscera compresses major vessels and affects venous return and cardiac output (Dunlop et al., 1994).

Fasting for 48 hours has been shown to decrease heart rate and cause sinus arrhythmia in adult cattle, and heart rate does not return to baseline until 24–48 hours of resumption of normal feeding (McGuirk et al., 1990).

E. Musculoskeletal System

Proper positioning of ruminants during anesthesia is important to facilitate blood flow to muscles and avoid pressure over nerves, especially in the larger ruminants. Ischemia of muscles and nerves can result in myopathy and neuropathy, respectively. Contributing factors are large body mass, prolonged recumbency, inadequate padding of body and limbs, improper positioning, and intraoperative hypotension. Myopathy

and neuropathy do not become evident until the animal attempts to stand. The dependent muscles are most affected and the triceps and gluteals are at the greatest risk for myopathy. Commonly affected nerves are the radial, peroneal, and tibial. Occasionally, the facial nerve is damaged from the pressure of a halter.

Padding of the surgery table is imperative for all ruminants, but the padding needs to be at least 12–15 inches thick for large cattle. All padding needs to be covered with a waterproof material. In lateral recumbency, the uppermost limbs need to be supported in a position parallel to the tabletop. This reduces pressure on the lower limbs. The lowermost thoracic limb must be pulled forward to prevent the triceps muscle and radial nerve from becoming trapped between the ribcage and tabletop. Rope restraints on the limbs and head should be padded, or removed if this can be done safely, to prevent damage.

III. PREMEDICATION

A. Restraint

Restraint of small ruminants and dairy calves is not problematic due to their small size and docile behavior, so special equipment is not necessary. An experienced handler can usually restrain small ruminants and young calves. Sheep, but not goats, tolerate being restrained or “set up” on their rump. Also, sheep tolerate restraint in lateral recumbency better than do goats. Sheep also endure restraint in slings.

However, restraint of adult cattle, and on occasion calves of beef breeds, may necessitate specialized facilities for safety reasons. A chute with a head restraint is absolutely necessary for certain techniques when dealing with large cattle. A hoisting mechanism may be necessary to lift cattle onto the surgery table, and specialized padding is required to prevent muscle and nerve damage in the recumbent animal.

A tilt table can be used for restraint and to facilitate some surgical procedures on adult cattle. The animal is led to the table, which is in the vertical position. The head is tied to the table and two straps (one around the chest and the other around the belly) are used to secure the animal to the table. Once the animal is secured, the table is tilted to the horizontal position. At the end of the procedure, the table is returned to the vertical position to deposit the animal on the ground. In many cases, this procedure can be performed on the awake or lightly sedated animal.

1. Casting Harness

Heavily sedated cattle generally become ataxic and, if proper handling facilities are not available, the animal may fall in an awkward position risking airway obstruction. A casting harness (Fig. 14-2) can be used to induce recumbency and restrain the

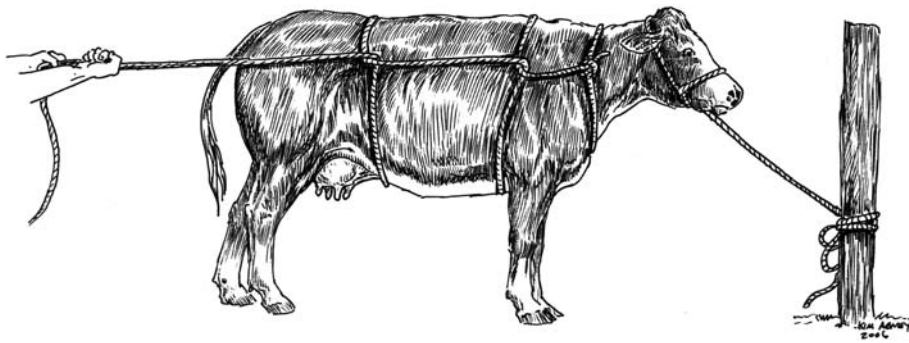

Fig. 14-2 Use of a double half-hitch casting harness. The harness is usually applied to the lightly sedated animal and facilitates casting and restraining the animal in sternal recumbency.

sedated animal. The halter is secured to a stout post in the ground and the animal is eased into sternal recumbency by pulling backward on the rope.

B. Drug Administration

Drugs for sedation and anesthesia can be administered intravenously or intramuscularly. Intramuscular (IM) injections are usually given into the semimembranosus or semitendinosus muscles. Small volumes of injectate can be given in the neck muscles.

1. Jugular Vein

In tractable animals, a jugular vein is generally used for IV drug administration. A catheter can readily be placed in the jugular vein of ruminants; however, the jugular vein may be difficult to catheterize in large bulls due to the thickness of the neck and skin. Desensitizing the skin over the vein, with lidocaine, facilitates the procedure in all cases. In most cattle, and many calves, it is prudent to make a small stab incision (e.g., no. 10 scalpel blade) in the skin over the vein. This makes it easier to insert the catheter and reduces the likelihood of damage to the catheter as it goes through the skin.

2. Auricular Vein

The auricular vein is sometimes used in large bovines where access to the jugular is restricted either by the thickness of the neck or by the animal's temperament. Also, this vein is relatively easily catheterized in small ruminants with large ears. The cephalic and saphenous veins are infrequently used for drug delivery.

3. Tail Vein

The tail vein may be used for injection of small volumes of a sedating (e.g., xylazine) or tranquilizing drug (e.g., acepromazine), especially when jugular administration cannot be

performed safely or easily. This method is convenient when adult cattle are restrained in a chute and access to the tail is available.

C. Sedation and Premedication

Drugs used for tranquilization/sedative properties vary in their effects on the different ruminant species. A drug with marked sedative effects may be recommended in an adult cow to facilitate handling, whereas drugs with less sedative effects or lower doses of the drug may be required in small ruminants due to the ease of handling.

Many surgical procedures (e.g., abdominal exploration) can be performed on standing, awake cattle using restraints (e.g., chutes) and either regional or local anesthesia. Sedation may be also be used in combination with local or regional anesthesia to facilitate some surgical interventions.

However, it is important to realize that ruminants, unlike horses, are likely to become recumbent once sedated and this can be especially problematic if an animal becomes recumbent during abdominal surgery or while restrained in a chute. In contrast, if the surgery is to be performed with the animal recumbent, sedation will facilitate restraint. Sheep and goats are quite likely to become recumbent after even mild sedation, but this is usually not a cause for concern, unless planning standing abdominal surgery, which is not commonly performed in the small ruminants.

Sedation is generally induced prior to the induction of general anesthesia. In this case, sedation will allow more control of the animal, reduce the dose of induction drugs(s) and facilitate a controlled induction, and in some cases reduce the dose of the maintenance anesthetic(s) and provide analgesia.

A review of these drugs has been presented elsewhere in this book. This brief review will outline the most important aspects of these drugs in ruminants.

1. Alpha₂ Agonists

Alpha₂ agonists are the most reliable drugs in terms of sedation and analgesia in the ruminant. The binding ratios to receptor

TABLE 14-2
COMMON DOSES FOR SEDATIVE DRUGS IN RUMINANTS

Variable	Adult cattle (mg/kg)	Calf (mg/kg)	Sheep (mg/kg)	Goat (mg/kg)
Acepromazine	0.02; IV, IM	0.02; IV, IM	0.02; IV, IM	0.02; IV, IM
Medetomidine	0.04; IV, IM	0.03; IV, IM	0.02–0.3; IV, IM	0.02; IV, IM
Xylazine	0.05–0.1; IV, IM	0.05–0.3; IV, IM	0.05–0.2; IV, IM	0.02–0.1; IV, IM
Detomidine	0.01; IV, IM	0.03; IV, IM	0.03; IV, IM	0.03; IV, IM
Romifidine	0.05; IV, IM	0.05; IV, IM	0.05; IV, IM	0.05; IV, IM
Diazepam	N/R	0.25–0.5; IV	0.25–0.5; IV	0.25–0.5; IV
Midazolam	N/R	0.1–0.3; IV, IM	0.1–0.3; IV, IM	0.4; IV, IM
Morphine	0.25–0.5; IV, IM	0.25–0.5; IV, IM	0.5; IV, IM	2; IV, IM
Butorphanol	0.05; IV, IM	0.05; IV, IM	0.1–0.5; IV, IM	0.05–0.1; IV, IM
Pentobarbital	2; IV	2; IV	N/A	N/A

Note: N/R: not recommended; N/A: not available.

Source: Carroll et al. (2005); Celly et al. (1997a); Doherty et al. (1986, 1987, 2002, 2004); Dunlop and Hoyt (1997); Haerdi-Landerer et al. (2005); Hodgson et al. (2002); Hsu et al. (1989); Kyles et al. (1995); Lin and Riddell (2003); O'Hair et al. (1988); Ranheim et al. (2000); Rioja et al. (2008); Skarda et al. (1990); Stegmann (1998); Thompson et al. (1989, 1991); Valverde et al. (1989); Waterman et al. (1991a).

TABLE 14-3
COMMON DOSES FOR INDUCTION DRUGS IN RUMINANTS

Variable	Adult cattle (mg/kg)	Calf (mg/kg)	Sheep (mg/kg)	Goat (mg/kg)
Pentobarbital	N/R	N/R	20–25	20–25
Thiopental	5–10	5–10	5–10	5–10
Propofol	N/R	3–5	3–5	3–5
Ketamine	2–2.5	5–10	5–10	10
Pentobarbital/xylazine	2/0.1	2/0.1	N/A	N/A
Xylazine ^a /ketamine	0.05–0.1/2–2.5	0.05–0.1/3–5	0.03–0.05/3–5	0.05–0.1/3–5
Ketamine/midazolam	2–2.5/0.04	4/0.4	4/0.4	4/0.4
Ketamine/diazepam	2–2.5/0.04	4/0.4	4/0.4	4–5/0.4–0.5
Xylazine ^a /ketamine/diazepam	0.05/2/0.1	0.05/3/0.4	0.03/5/0.4	0.03/5/0.4
Tiletamine–zolazepam (1:1 mixture)	N/A	4	4	4
Xylazine ^a /tiletamine–zolazepam	N/A	0.05/2	0.05/2	0.05/2
Xylazine ^a /ketamine/guaifenesin	0.05/2/75	0.05/2/75	0.05/2/75	0.05/2/75
Xylazine ^a /thiopental/guaifenesin	0.05/5/75	0.05/5/75	0.05/5/75	0.05/5/75

Note: N/R: not recommended; N/A: not available.

Source: Dunlop and Hoyt (1997); Greene (2003); Kyles et al. (1995); Lin et al. (1989); Pablo et al. (1997); Prassinis et al. (2005); Thurmon (1986); Reid et al. (1993).

^aCan be substituted by equipotent dose of another alpha₂ agonist.

subtype populations (alpha₂/alpha₁) of alpha₂ agonists are: medetomidine—1,620:1, romifidine—340:1; detomidine—260:1; and xylazine—160:1 (Virtanen et al., 1988). The analgesia, sedation, and cardiovascular effects associated with alpha₂ receptor agonists are alpha₂ mediated; however, alpha₁ activity is responsible for mediating some cardiovascular effects. Common routes of administration for alpha₂ agonists include intravenous (IV), IM, epidural, and intrathecal (Tables 14-2–14-4).

Alpha₂ adrenergic receptors located supraspinally and spinally mediate analgesia. Spinal alpha₂ receptors in the

superficial laminae of the dorsal horn (Bouchenafa and Livingston, 1987) and centrally in the periaqueductal gray area of the midbrain, the site of origin of the descending inhibitory pathways of pain, modulate the release of norepinephrine.

The sedative effects of alpha₂ agonists are dose dependent with rapid onset and result in mild sedation to recumbency. Ruminants are very sensitive to the effects of xylazine. Cattle and small ruminants may require only one-tenth or less of the xylazine dose used in other species. However, the dose of other alpha₂ agonists in ruminants is similar to other species (Lin and Riddell, 2003; Ranheim et al., 2000). There is no clear

TABLE 14-4
COMMON ROUTES AND DOSES FOR ANALGESIC DRUGS IN RUMINANTS

Variable	Dose (mg/kg)	Route	Duration of action (hours)	Species
Morphine	0.05–0.5	IM, IV	6	Cattle
	0.5	IM, IV	4–6	Goat
	0.1	Epidural	6–12	Cattle (diluted to 5–10 ml with sterile saline); goat (diluted to 3–5 ml with sterile saline or 1.5 mg/kg of bupivacaine)
Meperidine	5	IM	0.25–0.5	Sheep, cattle
Butorphanol	0.05–0.2	IM, IV	1–3	Sheep, goat
Buprenorphine	0.0015–0.006	IM, IV	0.75–3.5	Sheep
Fentanyl	0.01	IV	1–2	Sheep
Xylazine	0.05–0.2	IM, IV	2–4	Sheep, goat, cattle
	0.05	Epidural	2	Cattle (diluted to 5 ml with sterile saline)
	0.05–0.1	Epidural/ intrathecal	1–2	Sheep, goat (diluted to 2–3 ml with sterile saline)
Detomidine	0.003–0.01	IM, IV	2–4	Sheep, goat, cattle
	0.04	Epidural	3	Cattle (diluted to 5 ml with sterile saline)
	0.01	Intrathecal	1	Sheep (diluted to 2 ml with sterile saline)
Medetomidine	0.005–0.01	IM, IV	2–4	Sheep, goat, cattle
	0.015	Epidural	3–7	Cattle (diluted to 5 ml with sterile saline); goat (diluted to 3–5 ml with sterile saline)
Romifidine	0.003–0.02	IM, IV	2–4	Sheep, goat, cattle
	0.05	Intrathecal	1–2	Goat (diluted to 2–3 ml with sterile saline)
Lidocaine	2.5	IV	1	Goat (CRI at 0.05–0.1 mg/kg/min)
	0.2–0.4	Epidural	1–2	Cattle
	0.4–2.0	Epidural	1–2	Sheep, goat
Bupivacaine	1.5–1.8	Epidural	2–3	Sheep, goat
	0.05	Epidural	2–3	Cattle

Source: Modified from Valverde and Doherty (in press).

explanation for these differences between xylazine and other α_2 agonists when comparing receptor density and receptor subtype population (Törneke et al., 2003) or pharmacokinetics of xylazine (Garcia-Villar et al., 1981) in the different species. The difference appears to be of pharmacodynamic origin, since α_2 agonists cause a conformational change on binding of receptors, which facilitates contact with the G-protein and the clinical effect (i.e., sedation) (Gilman, 1987). In cattle, using in vitro techniques with brain tissue, the affinity for binding of the G-protein to the receptor is higher for xylazine than for detomidine, when compared to pigs and rats, reflecting higher coupling efficiency in cattle (Törneke et al., 2003).

The most common cardiovascular effects from α_2 agonists are associated with the central and peripheral effects on α_1 and α_2 receptors. Central effects on α_2 receptors decrease the sympathetic discharge and release of norepinephrine and lead to hypotension and reduced cardiac output. Peripheral effects on α_2 and α_1 receptors result in an increase in vascular resistance and blood pressure, which elicit a parasympathetic response that results in bradycardia and atrioventricular block. Therefore, it is possible to see a biphasic response characterized by initial hypertension from peripheral

effects and subsequent hypotension from central and peripheral effects. This biphasic response is less common after xylazine administration, where hypotension is usually the response, and tends to be longer lasting after detomidine and romifidine (Carroll et al., 2005; Celly et al., 1997b; Doherty et al., 1986; Kästner et al., 2005; Rioja et al., 2008; Stegmann, 1998).

Small ruminants may be more sensitive than cattle to the effects of α_2 agonists on respiratory function, particularly if these drugs are given rapidly intravenously at relatively high doses. In contrast, IM administration of a low dose of xylazine (0.05 mg/kg) was reported to have minimal effect on cardiorespiratory function (Grant and Upton, 2001) in sheep.

The respiratory effects of α_2 agonists vary from tachypnea in sheep to bradypnea in other ruminants, and undesirable effects on gas exchange and blood gases in sheep and to less extent in other ruminants. There is variability among the different breeds and even among individuals of the same breed of sheep on their response to α_2 agonists. A recent review on the effects of α_2 agonists in sheep (Kästner, 2006) summarizes the possible mechanisms that lead to hypoxemia and pulmonary edema. These side effects are dose-dependent and a direct consequence of α_2 agonists because α_2

antagonists, such as idazoxan and atipamezole, but not alpha₁ antagonists, such as prazosin, prevent them. Relief of side effects is possible if antagonists are administered shortly after (less than 10 minutes) the onset of side effects, but not if histopathological changes have already occurred in the lungs. Histological changes include interstitial and alveolar edema from capillary rupture that require time for repair (Celly et al., 1999; Kästner, 2006). The degree of induced hypoxemia is similar for the different alpha₂ agonists (xylazine, romifidine, detomidine, and medetomidine), despite the different selectivity for alpha₂ and alpha₁ receptors, and can outlast the duration of sedation (Celly et al., 1997b).

Cellular and mechanical mechanisms are implicated in the onset of hypoxemia and pulmonary edema. Increases in transpulmonary pressure, decreases in pulmonary compliance, pulmonary congestion from increases in pulmonary and systemic vascular resistance, and release of prostaglandins and vasoactive substances from PIMs contribute to different extents to hypoxemia (Celly et al., 1997b, 1999; Kästner, 2006).

The alpha₂ agonists should be used with caution in the last trimester of pregnancy, since xylazine has been shown to increase myometrial tone in the cow and goat, associated with an increase in uterine vascular resistance, a decrease in uterine blood flow, and a decrease in PaO₂ in the mother and fetus (Hodgson et al., 2002; Jansen et al., 1984; LeBlanc et al., 1984; Sakamoto et al., 1996). Detomidine appears to have less effect on uterine electrical activity in the cow (Jedruch and Gajewski, 1986).

Other effects of alpha₂ agonists include increased urine production associated with hyperglycemia (Carroll et al., 2005; Ranheim et al., 2000). Hyperglycemia is caused by inhibition of insulin secretion from binding of alpha₂ agonists to pancreatic beta-cells (Angel et al., 1990).

The effects of alpha₂ agonists, including analgesia, can be reversed by specific antagonists, such as idazoxan, atipamezole, tolazoline, and yohimbine (Doherty et al., 1986, 1987; Haerdi-Landerer et al., 2005; Hsu et al., 1989; Skarda et al., 1990; Thompson et al., 1989, 1991) (Table 14-5). Yohimbine is less effective than other antagonists.

a. Clinical considerations

Xylazine is the most commonly used member of the group, but detomidine, medetomidine, or romifidine may be used. Because these drugs have profound effects on many organ systems, the animal's physical status, dose, and route of administration should be considered carefully when pondering their use. Because of the effects of xylazine and possibly other alpha₂ agonists on uterine contractions and uterine blood flow, their use is not recommended in heavily pregnant ruminants.

The degree of sedation is dose-related. Cattle may remain standing following lower doses (e.g., xylazine 0.01 mg/kg, IV), but it is best to avoid this group of drugs if standing abdominal surgery is planned. If xylazine is used alone, a dose of 0.1 mg/kg

TABLE 14-5
COMMON IV DOSES FOR ANTAGONIST DRUGS IN RUMINANTS

Variable	Cattle (mg/kg)	Sheep (mg/kg)	Goat (mg/kg)
Idazoxan	0.03–0.1	0.05	N/A
Atipamezole	0.03–0.1	0.005	100
Tolazoline	0.3	2	N/A
Yohimbine	0.125	0.125–0.2	N/A
Flumazenil	N/A	0.02	N/A
Naloxone	N/A	0.2	N/A

Note: N/A: not available.

Source: Carroll et al. (2005); Celly et al. (1997a); Doherty et al. (1986, 1987, 2002); Dunlop and Hoyt (1997); Haerdi-Landerer et al. (2005); Hodgson et al. (2002); Hsu et al. (1989); Kyles et al. (1995); Lin and Riddell (2003); O'Hair et al. (1988); Rioja et al. (2008); Skarda et al. (1990); Stegmann (1998); Thompson et al. (1989, 1991); Waterman et al. (1991a).

IV will generally produce recumbency of dairy cattle; but the effects are less predictable in beef cattle, especially the less tame animals. Alternatively, a lower dose of xylazine can be given, and the animal can be cast with a casting harness (Fig. 14-2) Regurgitation may be more likely when higher doses of xylazine are used.

For sedation of small ruminants, a low dose of an alpha₂ drug (e.g., xylazine 0.03 mg/kg and medetomidine 0.006 mg/kg) can be given IM, and further sedation can be achieved with a benzodiazepine (e.g., diazepam 0.1–0.5 mg/kg, IV) or a combination of diazepam and ketamine given, to effect, IV. Low doses of alpha₂ agonists (e.g., xylazine 0.03 mg/kg, IM) facilitate handling of small ruminants prior to induction of general anesthesia and do not prolong recovery significantly.

The reported comparative sedating effects of IV administered alpha₂ agonists in sheep indicate that 0.15 mg/kg xylazine is equivalent to 0.03 mg/kg detomidine, 0.03 mg/kg medetomidine, or 0.05 mg/kg romifidine (Celly et al., 1997b).

2. Phenothiazines

Acepromazine is the most commonly used phenothiazine in ruminants (Table 14-2). Sedation caused by acepromazine is less profound and slower in onset (up to 10 minutes after IV administration) than for alpha₂ agonists (Hodgson et al., 2002). Acepromazine does not have analgesic properties; however, similar to effects in other species, it can decrease the dose of inhalant anesthetics (minimum alveolar concentration—MAC) (Doherty et al., 2002).

Cardiorespiratory effects are minimal, with no change in heart rate, a slight decrease in respiratory rate with no consequences on arterial blood gases, and minimal effects on uterine blood flow (Hodgson et al., 2002). Due to its alpha-adrenergic blocking properties acepromazine may potentiate hypotension in volume-depleted animals.

Acepromazine used as a preanesthetic, at a relative high IV dose of 0.5 mg/kg in sheep, prevented the occurrence of epinephrine-induced dysrhythmias from cardiac sensitization in halothane-anesthetized and conscious sheep (Rezakhani et al., 1977). It is likely that lower doses of acepromazine in ruminants also have an antiarrhythmic effect, as it has been shown in other species including dogs (Dyson and Pettifer, 1997).

a. Clinical considerations

Despite the minimum sedation caused by acepromazine, it appears to reduce the dose of induction drugs and decreases the MAC of volatile anesthetics in ruminants (Doherty et al., 2002). Since the MAC reducing effects are not dose related, it is recommended that the lowest dose be used.

In adult cattle, especially large bulls, it is observed that low doses of acepromazine (10–15 mg, IV) exert a mild sedating effect and the animals remain standing. Acepromazine can also be combined with a very low dose of xylazine (0.01 mg/kg, IV) for sedating large cattle, and animals generally remain standing at these doses.

3. Benzodiazepines

Diazepam and midazolam are the most commonly used drugs in this group (Tables 14-2 and 14-3). Zolazepam has also been used combined with tiletamine to induce general anesthesia in calves (Lin et al., 1989). Benzodiazepines have minimum and transient cardiorespiratory effects and are safe to use in small ruminants and calves for sedation and restraint, despite the potential for initial excitement. These drugs should not be used in adult cattle because of the risk of ataxia and difficult control during the excitement phase. In adult cattle, benzodiazepines are more commonly used as part of an induction technique. Salivation is commonly observed in sheep (Kyles et al., 1995) but is minimal in goats (Stegmann, 1998).

Diazepam (0.4 mg/kg, IV) in sheep and midazolam (0.4 mg/kg) in goats lowered PaO₂ and did not affect PaCO₂ after IV administration; however, the degree of hypoxemia is of a lesser magnitude and duration (less than 15 minutes) than with alpha₂ agonists (Celly et al., 1997a; Stegmann, 1998).

The actions of benzodiazepines on gamma-aminobutyric acid (GABA)/benzodiazepine receptors play a role in antinociception as demonstrated in midazolam-treated sheep undergoing mechanical and thermal stimulation (Kyles et al., 1995). The effects of benzodiazepines can be reversed with flumazenil or sarmazenil; however, there is generally no need for reversal or benzodiazepines, unless grossly overdosed (Table 14-5).

a. Clinical considerations

The use of diazepam and midazolam as sedatives is generally restricted to small ruminants and calves. Diazepam is generally given IV, as it is a tissue irritant and its absorption is somewhat

unpredictable following IM administration. Midazolam is water soluble and nonirritating to tissues.

The excitement that may occur from IV administration of benzodiazepines to conscious sheep or goats appears to be related to the low doses and the speed of administration. Moderate doses of diazepam (0.2–0.5 mg/kg, IV), administered slowly, give a short period of sedation and recumbency, which may be sufficient for short, nonpainful procedures. For more reliable sedation, diazepam (0.5 mg/kg) can be combined with ketamine (2–3 mg/kg) and the mixture can be given, slowly IV to effect. An alternative is to administer the benzodiazepine with an alpha₂ agonist (Tables 14-2–14-4).

4. Opioids

Opioids are less commonly used in ruminants than in other species (Tables 14-2–14-4). Opioid receptors, classified as mu, kappa, and delta (OP3, OP1, and OP2, respectively) are present throughout the body and are responsible for the desirable analgesic effects. As in other species, the use of opioids in ruminants can be associated with adverse behavioral effects from central nervous system (CNS) stimulation, which mask the sedative effects of these drugs. Despite the excitatory effects, morphine (2 mg/kg, IV) administered to anesthetized goats has been shown to decrease the MAC of isoflurane, probably due to its analgesic properties (Doherty et al., 2004). Conversely, butorphanol (0.05–0.1 mg/kg, IV) had no significant effect on MAC of isoflurane in goats under the same study conditions (Doherty et al., 2002), which may indicate that the kappa effects may be less important for the type of noxious painful stimulus used or that the adverse behavioral effects from butorphanol were more obvious than those from morphine.

In adult cows, the administration of butorphanol (0.05 mg/kg, IV) with alpha₂ agonists (xylazine or detomidine) resulted in shorter duration of sedation than when the alpha₂ agonists were used individually. In addition, half of the cows receiving detomidine with butorphanol exhibited nystagmus (Lin and Riddell, 2003). In sheep, butorphanol (0.1–0.2 mg/kg, IV) caused behavioral changes (Waterman et al., 1991a). These effects are less likely to occur if the drug is given subcutaneously, as a higher dose of butorphanol (0.5 mg/kg) induced sedation and analgesia when administered subcutaneously (O'Hair et al., 1988).

The presence of opioid receptors in the brain, spinal cord, and joints allow administration of opioids by systemic, spinal/epidural, and intraarticular routes. Their effects can be reversed by naloxone (Table 14-4).

a. Clinical considerations

Opioids do not provide reliable sedation in ruminants and may cause behavioral changes that result in agitation and chewing. However, their administration to the anesthetized patient is less likely to cause excitement and is useful due to their analgesic properties. Intraoperative morphine (2 mg/kg, IV)

reduced the isoflurane MAC in goats by approximately 29% (Doherty et al., 2004). Morphine has not been observed to produce adverse effects in awake small ruminants (0.5 mg/kg, IM) or cattle (0.25–0.5 mg/kg, IM) when administered for analgesic purposes (authors' observations).

5. *Pentobarbital*

Pentobarbital is a short-acting anesthetic that in subanesthetic doses (2 mg/kg, IV) causes moderate sedation for about 30 minutes in adult cows without causing recumbency, although mild-to-moderate ataxia is observed (Valverde et al., 1989). The effects of this dose on arterial blood gases, respiratory rate, heart rate, blood pressure, and rumen motility is minimal. Similar effects have been observed in calves using the same dose.

Pentobarbital is also used as an induction agent (Tables 14-2 and 14-3).

a. Clinical considerations

The interesting feature of pentobarbital-induced sedation in cows is that they remain standing, which makes its use ideal for facilitating movement of animals from place to place. If used prior to xylazine administration in cattle the combination will induce a light plane of anesthesia sufficient to allow intubation of the airway. The disadvantage is that a relative large volume of injection is needed in adult cattle, and therefore an IV catheter is recommended.

IV. INDUCTION

A. Recommendations for General Anesthesia

To reduce the incidence of gastrointestinal associated problems it is important to:

1. Fast ruminants for at least 24 and up to 48 hours prior to induction of general anesthesia or heavy sedation.
2. Withhold water for 12–18 hours.
3. Place an endotracheal tube to protect the airway.
4. Assure that the animal is adequately anesthetized prior to attempting passage of the endotracheal tube.
5. Retain the animal in sternal until the endotracheal tube is secured. In adult cattle, due to the difficulty in maintaining them in sternal, the experienced anesthetist can intubate in lateral recumbency if the intubation is completed promptly.
6. Recover the animal in sternal recumbency.
7. Retain the endotracheal tube in position until the animal starts to swallow and remove it while the animal is sternal. If there is any indication that ruminal contents are present in the pharynx, or mouth, flush the oral cavity and drain, or suction, the pharynx prior to extubation.

8. Observe the animal closely during recovery and maintain it in sternal until it is has regained adequate muscle strength to do so unaided.

The benefits of fasting include:

1. Prevention of bloating.
2. Reduced severity of aspiration pneumonitis.
3. Decreased weight of gastrointestinal tract.
4. Improvement of respiratory function.
5. Improvement of cardiovascular function.

B. Induction of Anesthesia in Small Ruminants and Calves

In general, all animals should be sedated prior to anesthesia induction for reasons previously stated. Anticholinergics are not routinely administered.

1. *Pentobarbital*

Pentobarbital requires significant biotransformation to be eliminated. It is a relatively short-acting barbiturate in small ruminants in comparison to other species due to differences in biotransformation (Davis et al., 1973). While animals awaken from pentobarbital anesthesia at approximately the same plasma concentrations (5–8 mg/L), these plasma concentrations are reached at approximately 100 minutes in the goat compared to 900 minutes in the dog.

Cardiorespiratory effects include an increase in vascular resistance and heart rate, and stable blood pressures. Respiratory rate can be significantly depressed resulting in increased PaCO₂ and decreased PaO₂.

a. Clinical considerations

The use of pentobarbital alone as an induction agent is exclusive to small ruminants due to the faster biotransformation. In awake or mildly sedated sheep or goats, 20–25 mg/kg IV of pentobarbital is required to induce unconsciousness. Half of the pentobarbital dose is given rapidly and the remainder is administered over 5 minutes. In the moderately or heavily sedated animal, the dose is reduced accordingly.

2. *Thiopental*

Thiopental is an ultra-short acting barbiturate that provides smooth and rapid induction (Table 14-3). The quality of recovery is poor if animals are not premedicated.

Recovery from an induction dose of thiopental results primarily from redistribution of the drug from the highly perfused areas (i.e., CNS) to the less well-perfused tissues (i.e., skeletal muscle) and is longer than for other newer induction drugs, such as propofol. In goats administered thiopental (8 mg/kg, IV)

for induction and maintained under halothane anesthesia for 30 minutes, the time to recovery of the swallowing reflex (11 minutes), first head movement (20 minutes), sternal recumbency (38 minutes), and standing (44 minutes) are at least double those of goats administered propofol (3 mg/kg, IV) and halothane (Prassinis et al., 2005).

Apnea is common after rapid and/or excessive administration of thiopental. Decreased respiratory rate is also common with a concomitant decrease in PaO₂ and increase in PaCO₂; therefore, O₂ administration and ventilatory support is recommended. Heart rate tends to increase and blood pressure decrease after thiopental administration (Prassinis et al., 2005; Thurmon, 1986), and because of the depressive effects on myocardial function, cardiac output tends to decrease and dysrhythmias are likely (Thurmon, 1986).

Solutions of thiopental are irritant to tissues, especially if high concentrations are used, so care must be taken to avoid perivascular leakage.

a. Clinical considerations

Thiopental is not commonly used for induction of anesthesia in small ruminants or calves, primarily because better conditions for intubation occur following ketamine–diazepam administration. If used alone, a large dose of thiopental is required (15–20 mg/kg, IV) and is likely to result in a period of apnea. Lower doses (5–10 mg/kg, IV) are adequate for induction in premedicated animals.

3. Propofol

The cardiorespiratory effects and lack of analgesic properties of propofol are very similar to those of thiopental (Table 14-3). Respiratory and cardiac depression can be expected especially if higher than required doses are administered. Major differences include less arrhythmogenic potential and more rapid recovery from a single dose or from a constant-rate infusion. An advantage of propofol is its short context-sensitive half-life, which make it an almost ideal agent to maintain anesthesia as a constant-rate infusion. Unlike thiopental, propofol does not have cumulative effects and results in smooth recoveries (Prassinis et al., 2005).

It has been suggested that apnea induced by propofol is more related to dose than to rate of administration (Prassinis et al., 2005). Inductions are smooth, although myoclonic activity of the face or extremities observed in other species has also been described in goats (Pablo et al., 1997).

a. Clinical considerations

Propofol has no real advantage for induction over ketamine–diazepam in routine situations; however, it is a good choice for induction in cesarian section. Its short context-sensitive half-life facilitates its administration as a constant-rate infusion for

the maintenance of anesthesia. The potential for apnea and hypoxemia from propofol administration at induction can be handled by provision of oxygen by mask and by administering recommended doses to effect.

4. Ketamine

Ketamine induces a dissociative state of anesthesia, in which muscle tone is increased in the absence of drugs with muscle relaxant properties, and peripheral reflexes are maintained. It is recommended that ketamine be combined with drugs that provide sedation or muscle relaxation to facilitate induction and intubation (Table 14-3). Significant salivation can also occur from ketamine during intubation (Prassinis et al., 2005).

Ketamine-induced stimulation of the sympathetic system may improve cardiovascular function; however, it also can depress the myocardium through its negative inotropic effects (Bovill, 2006). The net effect is that heart rate may increase, but cardiac output and blood pressure remain unchanged or decreased. The effects of induction doses of ketamine (10 mg/kg), propofol (3 mg/kg), and thiopental (8 mg/kg) in goats were similar for heart rate, blood pressure, respiratory rate, and arterial blood gases (Prassinis et al., 2005). The recovery time of goats receiving ketamine was longer than for propofol or thiopental (Prassinis et al., 2005).

The inhibitory effects of ketamine on the *N*-methyl-D-aspartate (NMDA) receptor can result in an apneustic pattern, characterized by periods of apnea during inspiration. The effects of ketamine on the NMDA receptor are also responsible for its analgesic effects (Himmelseher and Durieux, 2005).

a. Clinical considerations

Ketamine should not be used alone for induction of anesthesia in the unsedated animal. Ketamine is not a complete anesthetic, even at the highest dose, and induces adverse effects, such as neuronal toxicity, which are dose-related. The adverse effects are reduced by prior sedation with an alpha₂ agonist or benzodiazepine or by simultaneous administration with a benzodiazepine.

5. Alpha₂ Agonist–Ketamine

Various combinations of xylazine and ketamine have been used to induce anesthesia by either the IV or IM route. Xylazine (0.05–0.1 mg/kg, IM or IV) and ketamine (3–5 mg/kg, IV or 5–10 mg/kg, IM) will induce anesthesia of varying length. Administration of large doses of alpha₂ agonists can cause severe respiratory depression and a prolonged recovery.

Due to the potential for regurgitation, the airway should be protected with a cuffed endotracheal tube, and supplemental oxygen should be provided to offset the respiratory depression and hypoxemia. Other alpha₂ agonists (e.g., medetomidine

0.005–0.01 mg/kg, IV or IM) can be substituted for xylazine; however, the same concerns exist.

6. *Ketamine–Benzodiazepine*

Anesthesia may be induced with IV administration of ketamine and either diazepam or midazolam. The advantage of these combinations is the relative lack of cardiorespiratory depression; however, rapid administration of the mixture can cause a temporary apnea. For this reason, it is safest to give the combination slowly to effect, even if this results in more of the mixture being administered.

Relatively large doses of both drugs are needed to induce anesthesia in goats, if no other sedative agent is used concurrently. Ketamine (5 mg/kg) and diazepam (0.5 mg/kg) are mixed and initially one-quarter of the dose is administered IV to induce relaxation and allow the goat to be placed on the surgery table in sternal while oxygen is administered. The remainder is then given in increments over approximately 2 minutes until the required depth of anesthesia is reached for intubation. The combination of midazolam (0.4 mg/kg) and ketamine (4 mg/kg) has also been recommended (Stegmann, 1998).

Lower doses of each drug have been reported to be adequate for intubation of sheep (Dunlop and Hoyt, 1997) which may be a result of sheep being more sensitive to the drug or perhaps more rapid administration of the drug.

7. *Xylazine–Ketamine–Diazepam*

In healthy sheep, goats, and calves, the combination of xylazine, ketamine, and diazepam is one of the most commonly used mixtures. Animals are given a low dose of xylazine (0.03 mg/kg, IM) and mild sedation becomes evident in 10–15 minutes. Ketamine (5 mg/kg) and diazepam (0.3–0.5 mg/kg) are mixed and given IV to effect as described above. The remainder of the mixture is generally given when the animal is intubated and being ventilated.

The advantages of adding xylazine are an increased ease of handling, added analgesia, and a reduction in the induction and maintenance doses of inhalational anesthetic. Recovery is minimally affected by the addition of xylazine at this dose.

8. *Xylazine–Tiletamine–Zolazepam*

The mixture is similar to ketamine–diazepam in that an NMDA antagonist (tiletamine) is combined with a GABA agonist (zolazepam). The combination is commercially available as a powder containing either 250 mg of each drug. However, the mixture is reported to be a poor analgesic and is best combined with an alpha₂ agonist if it is to be used for restraint in short surgical procedures. It is not commonly used in small ruminants, but a dose of 2 mg/kg IM or IV and xylazine (0.05 mg/kg, IM) will induce anesthesia of about 15-minute duration.

Since the mixture of tiletamine–zolazepam is rapidly acting following IM administration and can be reconstituted in a small volume of alpha₂ agonist, it is useful for remote capture of nondomestic or unapproachable animals.

9. *Inhalational Agent*

The technique of “mask induction” has been recommended because of a rapid recovery from anesthesia. The authors do not recommend this method for a number of reasons: (1) mask induction is polluting to the local environment; (2) inhalational drugs are not good analgesics; and (3) inhalational agents cause dose-dependent cardiovascular depression. Also, if this method alone is used for induction, intubation may not be feasible as it can be difficult to get the animal deep enough to abolish the swallowing reflex.

C. *Induction of Anesthesia in Adult Cattle*

General anesthesia of adult cattle presents unique problems due to their size and temperament. Adequate facilities, personnel, and equipment must be available before considering anesthesia of adult cattle. While a variety of induction techniques have proven effective, only those in common use are described here.

It is thought that problems with regurgitation are less likely if the induction process is gradual and controlled and if the animal is adequately anesthetized prior to attempting intubation.

1. *Alpha₂ Agonist–Ketamine–Diazepam*

Following alpha₂ agonist-induced sedation (e.g., xylazine), anesthesia can be induced with ketamine or preferably a mixture of ketamine and diazepam IV. Xylazine can be administered IV (0.05 mg/kg) or IM (0.05–0.15 mg/kg), but not all cattle become recumbent at these doses. Higher doses of xylazine may be more likely to induce regurgitation, so it is probably best to use lower doses of xylazine and employ a casting harness to make the animal recumbent. Depending on the degree of sedation, anesthesia can be induced, to effect, with ketamine (2–2.5 mg/kg) and diazepam (0.05–0.1 mg/kg). Diazepam provides additional sedation and relaxation.

2. *Alpha₂ Agonist–Ketamine–Guaifenesin*

Adding guaifenesin to the induction regimen increases the degree of muscle relaxation and may provide some sedation. Following an alpha₂ agonist (e.g., xylazine 0.1 mg/kg, IM; 0.05 mg/kg, IV) premedication, ketamine (2–2.5 mg/kg) is mixed with guaifenesin (50–75 mg/kg) and approximately half of the mixture is initially infused rapidly, IV, until the animal is adequately relaxed to insert a dental speculum and assess readiness for intubation. The remainder of the mixture can be given

more slowly, as required. Relatively large volumes of guaifenesin are needed (0.5–1 L of 5% solution), and while this may be considered a disadvantage, it is also advantageous in that the likelihood of apnea is greatly reduced by the provision to give the mixture over a longer period.

Another method is to give approximately half the guaifenesin and then administer the ketamine separately as a bolus. However, mixing the drugs allows for a more gradual induction.

3. *Alpha₂ Agonist–Thiopental–Guaifenesin*

In this method, thiopental (4–5 mg/kg) is added to guaifenesin (50–75 mg/kg) and the mixture is infused, to effect, following premedication with an alpha₂ agonist, as described above. This method provides good relaxation and reduces the dose of thiopental needed for induction.

4. *Alpha₂ Agonist–Pentobarbital*

Anesthesia can be induced with pentobarbital (2 mg/kg, IV) following alpha₂-induced sedation (e.g., xylazine 0.05–0.1 mg/kg IV). This same technique can also be employed in calves.

D. Remote Capture of Ruminants

On occasion, it is necessary to deliver drugs to ruminants by some remote method. This is most likely to be necessary in an adult bovine, either because the animal has escaped from the holding facilities or because it is dangerous to approach.

For drug delivery at relatively close range (<3 m) a pole syringe is adequate; however, for longer distances a blow pipe (5–10 m), pistol (up to 20 m), or rifle (20–40 m) is necessary. Due to the relatively small volume of solution that can be delivered (3–10 ml), and the need for a rapid onset of effect, the drug options are limited. Also, it is desirable that the drug(s) be reversible and readily available in a hospital setting.

Alpha₂ agonists can be used alone to induce recumbency but very large doses are required. In a study in free-ranging cattle, xylazine (0.55 mg/kg) or medetomidine (0.04 mg/kg, IM) alone was successful in inducing immobilization in approximately 10 minutes while reversal was achieved with atipamezole (0.06 mg/kg, IV) (Arnemo and Soli, 1993).

The dose of alpha₂ agonists can be reduced considerably by the addition of ketamine (3–5 mg/kg) or tiletamine–zolazepam (2–3 mg/kg). Drug regimens based on ketamine or tiletamine–zolazepam (Telazol[®]) and alpha₂ agonists are generally the most readily available. Telazol can be reconstituted with the alpha₂ agonist to decrease the volume. Detomidine and medetomidine are more potent than xylazine and have a smaller volume, and thus are more suitable than xylazine for this purpose.

V. GENERAL ANESTHESIA

A. Anesthetic Equipment

Small ruminants and small calves do not generally need special anesthetic machines, ventilators, or endotracheal tubes. General anesthesia of adult cattle requires a large animal anesthesia machine and large endotracheal tubes and surgery tables. A hoisting mechanism is necessary to lift cattle onto the surgery table and special padding is required to prevent muscle and nerve damage in the recumbent adult.

B. Endotracheal Intubation

Intubation of the airway is necessary in the anesthetized ruminant to prevent the aspiration of saliva and ruminal fluid. In addition, endotracheal intubation is an effective method for delivery of oxygen and inhalational anesthetics. Endotracheal intubation is relatively easy in small ruminants but is more difficult in adult cattle.

In adult cattle, it is necessary to use a dental speculum, such as a Drinkwater gag (Fig. 14-3), to pry the jaws open and protect the tube from injury. The molar teeth of ruminants are rather sharp and can cause damage to the endotracheal tube or the hand of the intubator.

Direct visualization of the larynx is not possible in adult cattle as the view is obstructed by the protuberance (torus linguae) on the tongue. It is important that the animal is adequately anesthetized before attempting to place the gag and pass the endotracheal tube. The head and neck must be extended. Ideally, ruminants should be intubated while in sternal recumbency to reduce the chance of passive reflux of ruminal contents.

Endotracheal tubes should have an intact cuff and it is advisable to place the largest tube possible to prevent foreign material from entering the larynx. In adult cattle (450–600 kg), a tube size of 24–26 mm internal diameter is required. Once inserted, the cuff should be inflated and the tube secured to the head, with tape or bandage material, before moving the head or repositioning the animal.

A number of techniques can be used for the intubation of ruminants. Orotracheal intubation is the preferred method as the nasal passages of ruminants are relatively narrow. The nasal passages of sheep and goats are easily damaged and may bleed profusely; thus, nasotracheal intubation is not recommended.

C. Intubation of Small Ruminants and Calves

Sheep have a slightly larger airway than goats and, depending on their size, will generally require a tube of 8.5–14.0 mm internal diameter. Many goats are of smaller size, and goats

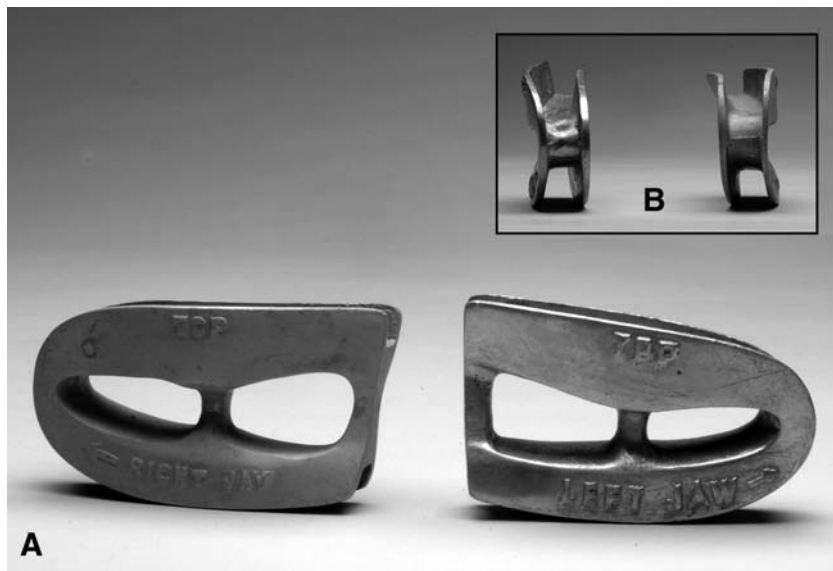

Fig. 14-3 Images of Drinkwater gags. A specific gag is used for the right and left side (A). Inset shows how the gags are curved to fit the dental arcade (B).

50–70 kg generally accommodate a tube of size 7.5–9.0 mm. Tubes of size 11–14 mm are required for calves 50–70 kg. A mouth gag is generally not necessary for small ruminants. Tubes are secured in place by tying them around the maxilla or behind the ears.

1. *Direct Visualization of the Larynx*

This is easiest to achieved animal in sternal recumbency. As the head is short and the dorsum of the tongue less prominent than in the adult bovine, the larynx is generally easy to visualize using a laryngoscope. A blade of length 20 cm is adequate for most small ruminants and small calves; however, a 40 cm blade is necessary to reach the larynx of larger calves and sheep.

Once the animal is adequately anesthetized, an assistant holds the mouth open using two lengths of gauze bandage and the head and neck are extended. The blade of the laryngoscope is used to depress the epiglottis to allow visualization of the rima glottidis. In most cases, passage of the endotracheal tube is facilitated by the use of a stylet to stiffen the tube.

2. *Blind Intubation*

This is easy to perform in small ruminants. However, the technique does take some practice, and the animal must be adequately anesthetized to be successful. The animal can be placed in sternal or lateral recumbency (avoid placing the animal in dorsal until the airway is secured).

The mouth is opened, as described above, and the head and the neck are extended. If the animal is in lateral, an assistant can hold the mouth open while gently extending the head over his or her hip. The intubator passes the tube into the pharynx and

gently grasps the larynx with the free hand when attempting to pass the tube. An experienced person can perform this maneuver rapidly.

D. Intubation of Adult Cattle

1. *Blind Intubation*

With this method, the head and neck are extended and the endotracheal tube is passed blindly toward the larynx while the free hand stabilizes the larynx by gripping it gently. This method is not very successful in adult cattle as the endotracheal tube usually gets lodged in the fossa linguae in front of the torus linguae.

Using a stomach tube as a guide increases the likelihood of success, as it is narrower and more likely to pass into the pharynx. Once the stomach tube enters the airway it acts as a guide for the endotracheal tube, which is passed over it into the trachea. The stomach tube is then removed.

2. *Direct Palpation of the Larynx*

This method is especially helpful in large cattle where the oral cavity is large enough to accommodate the forearm of the intubator and the endotracheal tube. A dental speculum is absolutely necessary to pry the jaws apart but the animal should be adequately anesthetized. The intubator passes the free hand into the pharynx while the driving hand guides the tube into the oral cavity toward the pharynx. The intubator then grasps the end of the endotracheal tube with the free hand and directs it into the larynx.

However, if the intubator has a large forearm or if the oral cavity is not sufficiently large, there may not be enough room to perform this procedure. In such cases, a stomach tube can be passed down the endotracheal tube to act as a guide. Since the stomach tube is of narrower bore and more flexible than the endotracheal tube, this method leaves more room for the operator's arm.

Before attempting intubation, the stomach tube should be passed down the lumen of the endotracheal tube to ensure that it fits, and verify that the endotracheal tube can be passed freely over it.

E. Maintenance of Anesthesia

1. Inhalational Anesthetics

Inhalational anesthetics are commonly used for maintenance of anesthesia in ruminants of all types. Nowadays, the most commonly used drugs are isoflurane and sevoflurane. Halothane is less frequently used but has proven to be an acceptable drug for maintenance of anesthesia in ruminants.

The cardiorespiratory depression from inhalant anesthetics is dose-dependent. MAC is the alveolar concentration of inhalation anesthetic that prevents movement in 50% of subjects in response to a noxious stimulus (Table 14-6). This means that the higher the MAC fraction delivered to the patient, the more pronounced the cardiovascular depression. The drugs used for premedication usually lower MAC.

Dose-dependent decreases in cardiac output, stroke volume, blood pressure, tidal volume, and respiratory rate, and dose-dependent increases in PaCO₂ are common with all inhalant anesthetics. Cardiovascular function is depressed to a greater extent with intermittent positive pressure ventilation (IPPV) than with spontaneous ventilation due to the effects of positive pressure on venous return and cardiac function, and also due to the effects of decreasing the stimulatory effects of PaCO₂ on the sympathetic system.

Halothane has a stronger negative inotropic effect; therefore, cardiac output is more affected with halothane. In addition, halothane affects vascular resistance less than sevoflurane or

isoflurane. Interestingly, the effects of 1–2 MAC of sevoflurane, isoflurane, and halothane resulted in similar cardiac outputs in goats under conditions of IPPV and spontaneous ventilation (Hikasa et al., 1998).

Halothane undergoes rather extensive (20–25%) metabolism compared to isoflurane (<1%) and sevoflurane (~5%). Its increased solubility in fat gives it a somewhat longer induction and recovery time.

N₂O is less commonly used in ruminant anesthesia for a variety of reasons. On the positive side, N₂O reduces the MAC of the volatile anesthetics; however, high-inspired percentages are required and this may result in the inadvertent administration of a hypoxic mixture if inspired oxygen is not monitored. N₂O diffuses into air-filled cavities (i.e., gastrointestinal tract) and may result in distention of viscera. The use of N₂O is not recommended.

2. Total Intravenous Anesthesia

Regardless of the method of total IV anesthesia used, it is strongly advised to intubate the airway and provide supplemental oxygen.

a. Xylazine–ketamine–guaifenesin

A method of total IV anesthesia that has been described for cattle (Greene, 2003) consists of adding xylazine (50 mg) and ketamine (1–2 g) to 1 L of 5% guaifenesin. Anesthesia can be maintained by infusing the mixture at 1–2 ml/kg/h, depending on the drugs used for premedication and induction and the type of surgery to be performed. The drug mixture can be made up accordingly for smaller ruminants. One advantage of this technique is reduced cardiovascular depression compared to inhalational agents.

b. Thiopental–guaifenesin

Anesthesia can also be maintained with an infusion of thiopental and guaifenesin. For adult cattle, thiopental (2–3 g) is added to 1 L of 5% guaifenesin and infused to effect. The amount used will depend on the type of sedation, the induction regimen, and the procedure in question, but is in the range 2–3 ml/kg/h. This regimen should not be used to provide prolonged anesthesia.

c. Partial intravenous anesthesia

This involves the combined use of inhalational and injectable anesthetics. The inhalational anesthetics are rarely used as the sole drug for maintenance of anesthesia. Isoflurane is supplemented by infusions of lidocaine and ketamine and the end-tidal isoflurane concentration for maintenance can be reduced to 0.5–0.6%.

Ketamine infused at 50 µg/kg/min is expected to give a MAC reduction of approximately 50% (Doherty et al., 2007),

TABLE 14-6

MINIMUM ALVEOLAR CONCENTRATION (MAC) VALUES (%) OF COMMONLY USED INHALANTS IN RUMINANTS

Inhalant	Cattle	Sheep	Goat
Halothane	0.76	0.69	0.96
Isoflurane	1.27	1.19–1.53	1.14–1.43
Sevoflurane	N/A	3.3	2.33

Note: N/A: not available.

Source: Bernards et al. (1996); Brett et al. (1989); Cantalapiedra et al. (2000); Doherty et al. (2002, 2004, 2007); Gregory et al. (1983); Hikasa et al. (1998); Lukasik et al. (1998).

and an infusion of 25 $\mu\text{g}/\text{kg}/\text{min}$ reduces MAC by about 30% (Queiroz-Castro et al., 2006). A loading dose (1–2 mg/kg) may be necessary if ketamine is not used for induction or if the infusion is not started soon after induction with ketamine.

A lidocaine infusion (100 $\mu\text{g}/\text{kg}/\text{min}$) reduced MAC by approximately 20% in goats (Doherty et al., 2007); however, the plasma lidocaine concentrations were lower than those reported in other species using similar infusion rates. It appears that small ruminants rapidly clear lidocaine; thus, higher infusion rates (e.g., 150–200 $\mu\text{g}/\text{kg}/\text{min}$) are recommended. A loading dose of 2.5 mg/kg is administered over 5 min.

F. Recovery from Anesthesia

The duration of recovery depends on the type and amount of drug(s) used. Delivery of anesthetic drug(s) is discontinued in anticipation of recovery. If an inhalational anesthetic has been administered, increasing the fresh gas flow will hasten the elimination of anesthetic from the circuit. If the animal has been ventilated mechanically, it is best to maintain on the ventilator until spontaneous breathing returns.

Prior to extubation, the animal should be placed in sternal recumbency, which is usually followed by the escape of ruminal gases up the esophagus. The pharynx should be drained by either lowering the head or by suction. Once extubated, the animal should be kept in sternal until it has adequate muscle tone to be able to right itself from lateral.

Ruminants generally recover quietly from anesthesia and are content to remain sternal until ready to stand.

VI. LOCAL AND REGIONAL ANESTHESIA

A. Local Anesthetics

Lidocaine, bupivacaine, and mepivacaine are the most commonly used local anesthetics in ruminants. Their mechanism of action involves blockade of sodium channels to prevent depolarization of nociceptors. Lidocaine and mepivacaine are shorter acting than bupivacaine due to their lower protein binding at the receptor, but faster in onset because of a more physiological constant of dissociation that facilitates passage through cell membranes.

Local anesthetics can be administered by perineural injection, by infiltration at nerve endings in the skin, and by injection into the epidural/intrathecal space to provide anesthesia of the corresponding innervated area. The simplest method of providing anesthesia is to infiltrate the surgical site with local anesthetic. This is easily performed for procedures such as suturing a small skin incision or removing a superficial tumor where only the skin has to be anesthetized. Anesthesia of the body wall, such as is necessary for abdominal surgery, requires anesthesia of all layers including the peritoneum and is more likely to result in

areas of incomplete block if the infiltration method is used. In such circumstances, regional anesthesia can be achieved with a paravertebral block of the nerves that supply this anatomical area. The use of systemic lidocaine has also been described for analgesic effects; although it is understandable that general anesthesia cannot be accomplished by this route. However, it is possible to achieve regional anesthesia by infusing local anesthetics into a peripheral vessel (see Sections VI and F).

In animals of low body mass, it is important to avoid systemic toxicity with local anesthetics. The toxic dose is related to blood concentrations of the local anesthetic. Injection of local anesthetic into the horn bud of a kid goat is an example of a situation where toxicity may arise. The small body mass of the kid together with the extreme vascularity of the horn bud may result in a toxic concentration of local anesthetic. There are no established toxic doses of local anesthetics for ruminants, although it is commonly mentioned that up to 10 mg/kg of lidocaine and 3–4 mg/kg of bupivacaine can result in toxicity.

Toxicity is dependent on multiple factors, rather than dose alone. In fact, toxicity is related to plasma concentrations, which are dependent on dose, the site of injection, degree of absorption from the site, concurrent administration of other drugs (e.g., combined with epinephrine), health status, and interindividual variation. Therefore, a dose of 10 mg/kg lidocaine may only be toxic if given IV. In humans peak plasma concentrations for other routes than IV follow the order: intercostal > epidural > brachial plexus > subcutaneous (Rosenberg et al., 2004).

CNS is most sensitive to lidocaine toxicity and signs include depression with sedation, visual disturbances followed by excitation and muscle twitching, unconsciousness, and seizures. The cardiovascular and respiratory systems are more resistant to toxicity, although cardiovascular depression and respiratory arrest can occur. Bupivacaine predominantly affects the cardiovascular system.

B. Epidural and Spinal Anesthesia

Spinal anesthesia is a form of regional anesthesia involving the injection of drugs into the spinal fluid. This method is not routinely practiced in ruminants.

Epidural anesthesia is a form of regional anesthesia involving the injection of drugs into the epidural space. The method can be used to provide complete anesthesia where motor and sensory block occurs or analgesia, which generally involves a partial sensory block. The epidural space is separated from the surrounding spinal cord and cerebrospinal fluid by the meninges. Epidural anesthesia can be divided into two types, posterior and anterior.

1. Posterior Epidural

In posterior epidural, motor control of the pelvic limbs is maintained and the animal remains standing. Thus, this technique is most commonly used to perform procedures on

the perineum or tail of standing cattle. This technique does not desensitize the scrotum or udder. It is less commonly used in small ruminants.

The site for a posterior epidural injection is the sacrococcygeal or first intercoccygeal space. Elevating and lowering the tail while palpating the area can identify the space at which the tail hinges. In younger cattle, the movement of the tail ceases at the sacrococcygeal space; however, in older cattle the sacrococcygeal space is ossified and the site of injection is the first intercoccygeal space.

A 20- or 18-gauge needle is passed, in the midline, between the vertebrae at a 10–15° angle to perpendicular. The needle is inserted to a depth of 3–5 cm, depending on the animal's size. On occasion, blood will flow from the hub and, in this case, the needle should be withdrawn slightly. If the needle is correctly placed, there is minimal resistance to injection. The position of the needle can be verified by placing a drop of local anesthetic or saline on the needle hub and, if placement is correct, the drop will run down the hub due to the relatively negative pressure in the epidural space.

The usual volume of injectate for a posterior block in adult cattle is 5–6 ml of 2% lidocaine. Volumes of >10 ml may cause weakness of the pelvic limbs resulting in recumbency.

2. Anterior Epidural

The technique creates anesthesia of the caudal abdomen and, depending on the volume of local anesthetic administered, a variety of abdominal surgical procedures can be performed.

The technique is used commonly in small ruminants for abdominal or pelvic surgery, most often to supplement general anesthesia or sedation. In small ruminants and calves, the technique involves the injection of drugs into the lumbosacral space. However, if a sufficient volume of drug is injected at the sacrococcygeal or intercoccygeal space it will migrate forward to create an anterior epidural block.

Since the administration of a local anesthetic at the lumbosacral space results in motor and sensory block of the pelvic limbs, the animal is unable to stand. For this reason, anterior epidural block is not commonly practiced in adult cattle as they may injure themselves when motor control is lost or when attempting to stand. Nevertheless, the technique is sometimes performed for cesarian operations on cows using a low flank approach. In this instance, 20 ml of 2% lidocaine is administered, into the spinal fluid, at the lumbosacral space and the cow is guided into sternal recumbency. Care must be exercised to ensure that the animal has sufficient motor control before allowing it to stand. The return of tail tone and leg movement indicates that the cow is ready to stand.

Another concern is that a high anterior epidural may result in hypotension due to blockade of the sympathetic tone, which results in vasodilation. Hypotension is more likely to develop when a larger volume of local anesthetic is given to desensitize the anterior abdomen and in animals that are hypovolemic.

C. Technique of Epidural Injections in Small Ruminants and Calves

The epidural injection can be made with the animal in sternal or lateral, depending on the preference of the operator. However, more even spread of anesthetic, and hence a greater chance of bilateral block will occur with the animal in sternal. In goats and young calves the lumbosacral space is easily palpable, but may be less obvious in large, well-nourished sheep. Flexing the lumbosacral spine will help to locate the site.

For most small ruminants and calves, a 20-gauge, 7.5 cm spinal needle is suitable; however, the space can be very narrow in small goats, necessitating the use of a 22-gauge spinal needle.

The landmarks are easily located. The distinct dorsal spinous processes of the lumbar vertebra readily distinguish them from the sacral vertebrae. Also, a line joining the anterior borders of the ilium crosses the spinous process of the last lumbar vertebra.

The operator places an index finger of the free hand in the center of the depression between the last lumbar vertebra and the first sacral vertebra. Depending on whether the animal is in dorsal or lateral, the heel of the hand holding the spinal needle is rested on the animal or the edge of the table for security, as the needle is made to enter the skin immediately in front of the index finger and is advanced into the epidural space. This distance is relatively short, especially in goats. Determining a lack of resistance as the needle passes into the epidural space is somewhat subjective and dependent on the bore and bevel of the needle.

On occasion, an inadvertent spinal tap happens and this becomes evident when spinal fluid drips from the hub following removal of the stylet. If this occurs, the spinal needle can be withdrawn slightly to reposition it in the epidural space or the injection can be given into the spinal fluid. If a spinal injection is given, it is generally recommended that the epidural dose be reduced by about 30–50%. In any case, spinal and epidural injections should be given slowly.

The dose of local anesthetic necessary depends on the location of the surgical site and lower doses are necessary if the surgery involves the pelvis or pelvic limbs. The sacrococcygeal injection of lidocaine (2%) at a rate of 1 ml/5 kg should produce anesthesia of the abdomen almost to the umbilicus. A lower dose will suffice for pelvic anesthesia.

D. Paravertebral Anesthesia

This technique is used most commonly in cattle to provide unilateral anesthesia of the abdomen for surgery on the standing animal.

Generally, thoracic nerve 13 and lumbar nerves 1 and 2 must be blocked. Lumbar nerve 3 is also blocked to provide better anesthesia of the caudal third of the abdominal flank. This technique is not suitable for surgery of the ventral abdomen. The

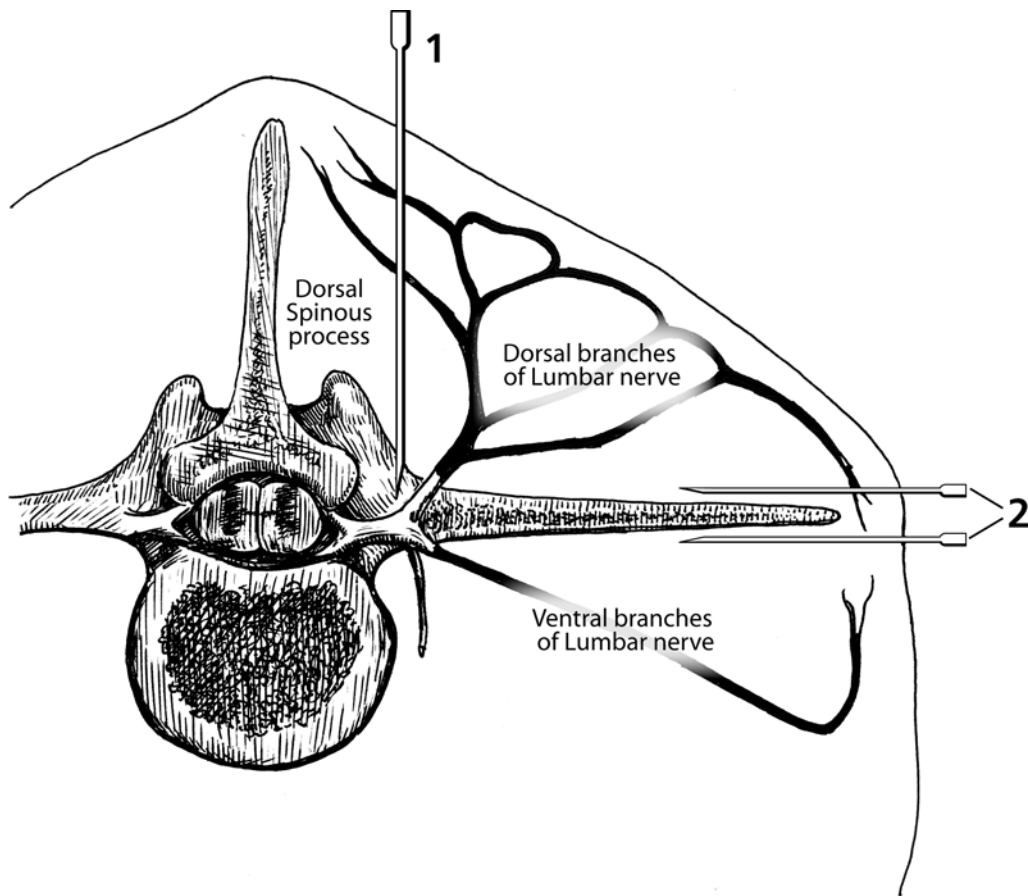

Fig. 14-4 Dorsal view of lumbar area depicting dorsal and ventral branches of lumbar nerve and location of needles for proximal (1) and distal (2) paravertebral block.

process involves the perineural injection of local anesthetic in proximity to the spinal nerves as they emerge from the vertebral canal. The dorsal and ventral branches of each nerve must be blocked if complete anesthesia of the flank is desired.

1. Proximal Block (Fig. 14-4)

Each spinal nerve emerges in front of a lumbar transverse process and then divides into a dorsal and ventral branch. Both branches of the nerve can be blocked by a single injection at this location. In this method, called the proximal block, the needle is inserted vertically, about 5 cm lateral to the dorsal spinous process in cattle, so that it just strikes the anterior rim of the transverse process behind the nerve to be blocked. The needle is then walked off the rim and directed deeper to penetrate the intertransverse ligament. This ligament is readily palpable in thin animals.

In adult cattle, about 10–15 ml of lidocaine are deposited just below the ligament and approximately 5 ml are injected above the ligament as the needle is withdrawn. The volume of local anesthetic is reduced appropriately in small ruminants and calves.

2. Distal Block (Fig. 14-4)

The distal or lateral approach is used to block the dorsal and ventral branches of the nerves as they cross over and under, respectively, the corresponding transverse process. In adult cattle, approximately 10 ml of lidocaine is injected above and below the transverse process. The injection is started at the tip of the process and the local anesthetic is deposited along the process, as the needle is advanced toward the spine. It is important to keep the needle close to the process; otherwise, the anesthetic is deposited in soft tissue and the block may fail.

E. Nerve Blocks of the Eye and Adnexa

Surgery of the eye is relatively uncommon in ruminants; however, enucleating is sometimes performed for conditions such as squamous cell carcinoma. It is possible to perform an enucleation with the animal standing, using either a four-point injection (retrobulbar block) to block the deep orbital nerves or a Peterson block to anesthetize the nerves as they exit the skull. Eye surgery in small ruminants is generally performed under general anesthesia.

1. *Four-Point Block (retrobulbar)*

In the awake, adult bovine, the animal is restrained in a chute and the head is secured. An 18- or 20-gauge 3-inch needle is inserted into the orbit at 12:00, 3:00, 6:00, and 9:00 positions. The injections can be made through the eyelids, if desired. The operator uses an index finger to deflect the globe away from the needle as it is inserted. The orbital septum must be penetrated; otherwise, the local anesthetic may be deposited subconjunctivally. The operator generally perceives the point when the needle penetrates the septum. In adult cattle, 5–10 ml of anesthetic are deposited at each site. Proptosis indicates a successful block.

A disadvantage of this technique is that there is a chance that the injection could damage the optic nerve. There is also a chance, albeit small, that the anesthetic could enter the cerebrospinal fluid, as the meninges extend around the optic nerve.

2. *Peterson Block*

This is technically more difficult than the four-point block. This block is not as reliable as the four-point block but is less likely to have complications. The nerves are blocked as they exit the skull at the foramen orbitotundum. The animal is restrained with its nasal bones parallel to the ground.

The needle is passed just in front of the rostral border of the coronoid process, in a notch formed by the zygomatic arch and supraorbital process, and directed slightly ventrally and posteriorly for about 3–4 inches in the adult bovine until it strikes bone. The local anesthetic (15–20 ml, 2% lidocaine) is injected at this location.

3. *Auriculopalpebral Block*

Auriculopalpebral anesthesia produces motor block of the upper eyelid, thus facilitating examination of the eye. The needle is passed through the skin at the end of the zygomatic arch and local anesthetic solution (5–10 ml, 2% lidocaine) is deposited, subcutaneously, at the dorsal border of the arch.

F. Intravenous Regional Anesthesia (Bier's Block)

IV regional anesthesia (IVRA) is a method suited to providing anesthesia of the distal limb for procedures such as surgery of the digits. The technique was first described by August Bier in 1808 as a method of providing anesthesia of the distal limbs in human patients.

The procedure is generally performed with the animal in lateral recumbency. Sedation is recommended as pain results from tourniquet application, especially if the procedure is prolonged. An IV catheter is placed in a distal vein of the limb in question; however, a butterfly needle may suffice. The circulation in the extremity is then isolated from the proximal portion of the limb by placing a tourniquet proximal to the site of injection. If a pressure cuff is used, it is inflated to a pressure greater than

the animal's systolic blood pressure to prevent arterial flow to the extremity. A cuff pressure of about 200 mmHg is generally sufficient; however, it is important to maintain the tourniquet inflated during the procedure.

If a pneumatic tourniquet is not available, the circulation can be occluded using a piece of rubber tubing. In cattle, a length of bicycle tire inner tube works well as a tourniquet.

A more effective method is to exsanguinate the extremity using an Esmarch rubber bandage. The limb is tightly wrapped, from distal to proximal, before applying the tourniquet. The tourniquet can be left in place for about 1 hour; however, the unsedated animal will become uncomfortable by this stage.

The choice of local anesthetic is less critical in adult ruminants; however, toxicity may result in small ruminants if a large volume of local anesthetic is suddenly released into the circulation following deflation of the cuff, so the choice of drug is important. Lidocaine is most commonly used. Bupivacaine should be avoided in small ruminants because the volume used may cause myocardial toxicity. Also, it is important that epinephrine-containing solutions are not used.

The volume of injectate will be influenced by the size of the limb and the location of the tourniquet. The presence of cellulitis in the limb will affect diffusion of anesthetic and a larger volume is required in such cases. In adult cattle, 30–40 ml of lidocaine may be necessary. In sheep and goats, 10–20 ml of lidocaine will suffice. The local anesthetic is injected slowly and anesthesia develops in about 5 minutes. Pressure builds up in the venous system as the injection progresses, and to prevent leakage and hematoma formation around the site of venipuncture, gentle pressure should be applied over the site.

Sensation returns soon after deflation of the tourniquet. It is recommended that the tourniquet not be deflated for at least 15 minutes following the injection, especially in animals of low body mass, to reduce the likelihood of toxicity. It may also help if the tourniquet is re-inflated after about 20 seconds, to release the local anesthetic solution in stages.

VII. ANESTHESIA FOR HUSBANDRY PROCEDURES

A. Dehorning and Disbudding

Dehorning or disbudding of ruminants is routinely performed to prevent damage to herd mates or handlers. The procedure is less stressful if it is performed at a young age before the horn develops to adult size.

In cattle, the sensory nerve supply to the horn arises from the superior maxillary branch of the trigeminal nerves. However, it is possible that a branch of cervical nerve two (C₂) supplies the caudal area of the horn.

1. The cornual branch of the zygomatico-temporal nerve is blocked along the temporal ridge, roughly halfway



Fig. 14-5 The lateral view of a goat's head demonstrates the locations for nerve block for dehorning an adult goat. The cornual branch of the lacrimal nerve (zygomatico-temporal) is blocked behind the root of the supraorbital process (1) and the cornual branch of the infratrochlear nerve is blocked at the dorsomedial margin of the orbit (2).

between the lateral canthus of the eye and the base of the horn.

2. The cornual branch of the infratrochlear nerve passes over the orbital rim close to the medial canthus and dorsal to the eye.
3. Cutaneous branches of C₂ may be blocked by injecting local anesthetic close to the dorsal midline of the neck and level with the base of the ear.
4. In a small percentage of animals the frontal nerve innervates the horn; however, this nerve is not possible to block as it runs deep in the temporal fossa or within the horn.

The cornual nerves of sheep and goat are very similar to those of cattle. Cervical nerve 2 is less likely to innervate the horn of the sheep and goat. In the goat, the cornual branch of the zygomatico-temporal nerve is often referred to as the cornual branch of the lacrimal nerve (Fig. 14-5).

1. The cornual branch of the lacrimal nerve (zygomatico-temporal) is blocked behind the root of the supraorbital process. The needle is inserted to a depth of 1–1.5 cm, and as close as possible to the root of the supraorbital process.
2. The cornual branch of the infratrochlear nerve is at the dorsomedial margin of the orbit and is generally palpable. The needle is inserted close to the margin of the orbit to a depth of about 0.5 cm.

In kid goats, disbudding is a very stressful procedure and care must be taken to avoid overdose of the local anesthetic. Since the horn bud is very vascular, there is a rapid uptake of drug from the injection site, and the small body mass makes overdose of anesthetic a concern. It is recommended that kids be anesthetized with xylazine (0.05 mg/kg, IM) and ketamine (10 mg/kg, IM) for disbudding. Recovery is complete within an hour and the process is much less traumatic for the kids. A non-steroidal anti-inflammatory (e.g., flunixin meglumine 2 mg/kg, IV or IM) is recommended for postoperative analgesia.

B. Castration

Castration of ruminants is routinely practiced and is less stressful if done when the animals are young. Although castration in the very young animal has been performed without anesthesia, the use of anesthesia is discouraged. The procedure can be performed under local anesthesia in cattle; however, smaller animals, especially young sheep and goats, could be anesthetized with xylazine (0.05 mg/kg, IM) and ketamine (10 mg/kg, IM) as described for disbudding. Castration of older sheep and goats must be performed carefully to prevent hemorrhage postoperatively. In such cases, sedation (e.g., xylazine 0.05–0.1 mg/kg, IM) will allow the animal to be restrained on a surgical table and improve surgical conditions.

For a complete anesthesia of the surgical site the scrotal skin and spermatic cord must be blocked. Local anesthetic can be injected directly into the spermatic cord using a small-bore needle (22-gauge) to reduce the likelihood of hematoma formation. Since local anesthetic is rapidly absorbed from this site, it is important to be aware of the risk of toxicity. In small lambs and kids, 1 ml of lidocaine in each cord will be adequate. The scrotal skin is anesthetized by local infiltration of lidocaine.

As in the case of dehorning or disbudding, a nonsteroidal anti-inflammatory (e.g., flunixin meglumine 2 mg/kg, IV or IM) is recommended for postoperative analgesia.

VIII. MONITORING THE ANESTHETIZED PATIENT

The degree of monitoring depends on a number of factors including the type of anesthetic and surgical procedure and physical status of the animal, and the facilities available. At minimum, the depth of anesthesia, heart rate and pulse pressure, and respiratory rate should be monitored. Most research facilities will have the necessary equipment to measure blood pressure and monitor the heart rate and rhythm.

A. Depth of Anesthesia

There is no single measure that can be used to gauge the depth of anesthesia. Thus, reliance is placed on clinical evaluation and

monitoring equipment to assess anesthetic depth. Obviously, motor movement, either spontaneous or in response to surgical stimulation, indicates an inadequate plane of anesthesia. Movement may involve the limbs or head or chewing movements.

Esophageal contraction is another indication of inadequate anesthesia and this can be followed by regurgitation. The bovine esophagus is unique in that it consists of striated muscle for its entire length. In humans, a link has been established between the depth of anesthesia, for certain anesthetics, and lower esophageal movement. In the case of halothane anesthesia, the frequency of lower esophageal contractions can predict movement in response to a skin incision; however, this relationship did not exist when humans were anesthetized with N₂O and alfentanil (Sessler et al., 1989).

The palpebral reflex and rotation of the eye are generally used as indicators of anesthetic depth. The palpebral reflex, which is elicited by stroking the eyelashes, progressively weakens as the depth of anesthesia increases and is absent or sluggish in surgical planes of anesthesia. During surgical anesthesia with inhalational anesthetics the eye is central initially but rotates ventrally as the anesthetic plane deepens until only the sclera is visible. In a very deep plane of anesthesia the eye will again become central, but this stage of anesthesia is distinguished by the loss of palpebral and corneal reflexes and severe cardiovascular depression. In comparison, when using multimodal anesthesia, the eye can remain in a central position corresponding to light surgical anesthesia under inhalational drugs.

The corneal reflex should be present at all times; however, it is recommended that this reflex not be elicited, as corneal damage may result. Nystagmus is not present during surgical anesthesia.

Anal tone is not a very precise method of assessing anesthetic depth, but may be helpful when there is no access to the animal's head. Stimulation of the anus causes reflex contraction of the anal sphincter and absence of this reflex indicates too deep an anesthetic plane.

Physiological indicators may be used to gauge anesthetic depth; however, it must be understood that commonly monitored parameters, such as heart rate, blood pressure, and respiratory rate, are subject to a variety of influences. Nevertheless, a rapid increase in heart rate and blood pressure is a strong indication of an inadequate plane of anesthesia.

The partial pressure of the inhalational anesthetic in the expired gases gives a good indication of the expected depth of anesthesia. Expired partial pressures closely reflect brain partial pressures, once equilibration has occurred. At 1 MAC, or less, an animal is expected to be inadequately anesthetized, unless supplementary anesthetics are used.

B. Cardiovascular Function

Cardiovascular monitoring involves, at a minimum, monitoring heart rate and rhythm and palpation of a peripheral artery

to estimate pulse pressure. The heart rate may be counted by digital palpation or measured from an ECG or blood pressure curve. Digital palpation of the artery is the simplest method of monitoring pressure but the method is subjective.

Blood pressure can be measured directly or indirectly.

1. Direct blood pressure in ruminants is usually recorded from a catheter in the medial auricular branch of the rostral auricular artery. This artery is readily catheterized in adult cattle and in lop-eared goats but may be quite difficult to catheterize in animals with small ears.
2. Indirect blood pressure can be measured using either the Doppler or oscillometric methods. With both techniques, the width of the cuff should be 40% of the circumference of the tail or limb. False readings may occur from incorrectly sized cuffs or, in the case of the Doppler, improper placement of the probe.

Cardiac output is not commonly monitored during anesthesia, unless this is part of the research protocol. However, the technique has become less complex, and relatively noninvasive methods (e.g., lithium dilution and partial carbon dioxide re-breathing methods) are now available.

C. Respiratory Function

The objectives of respiratory monitoring are to ensure adequate oxygenation of the blood and adequate removal of carbon dioxide. In the absence of monitoring apparatus, the minimum assessment should include determination of respiratory rate and mucous membrane color. Monitoring chest wall and abdominal movement and the movement of the re-breathing bag will help in the evaluation of respiratory function. Measurement of end-tidal carbon dioxide partial pressure (ETCO₂) and arterial blood gases give a more complete assessment of respiratory function.

1. Arterial carbon dioxide can be measured directly using blood gas analysis or indirectly using end-tidal analysis. End-tidal carbon dioxide monitors (capnographs) are readily available. End-tidal CO₂ values generally underestimate the PaCO₂ and increases in dead space ventilation increase this end-tidal to arterial gradient. Capnographs give a breath-by-breath analysis of changes in ETCO₂.
2. Arterial blood gas analysis remains the most accurate method of determining the partial pressures of oxygen and carbon dioxide in the animal's blood. The availability of patient-side analyzers has made this method of analysis more available.
3. Pulse oximetry makes the estimation of oxygen saturation available on a continuous basis. The probe is usually placed on the tongue but alternate sites are the nostril, lip, vulva, and prepuce. If the system is functioning properly, a value <90% indicates hypoxemia. The method may not always give reliable readings, especially if peripheral perfusion is poor.

D. Anesthetic Agent Concentration

As previously stated, the expired partial pressure of an inhalational anesthetic gives a close approximation of its partial pressure in the brain. Thus, anesthetic agent monitoring allows a more accurate approach to delivering anesthetic agents.

A potential problem in ruminants is interference with anesthetic measurement by methane. Methane is inhaled in eructated gases and later expired. The exhaled methane may interfere with anesthetic gas analysis if short-wavelength infrared (IR)-based technology is used. Methane absorbs IR light at a wavelength of 3.3 μm and thus can interfere with anesthetic measurements made with the so-called short-wavelength IR. Most modern anesthetic monitors function in the 10–13 μm range and are not affected by expired methane.

E. Body Temperature

Monitoring of body temperature is especially important in animals of low body mass. Anesthetics alter thermoregulation, and placing animals on cold surfaces, and maintaining a low environmental temperature, facilitate heat loss. Hypothermia adversely affects a variety of physiological processes including blood coagulation and wound healing.

Every effort should be made to prevent heat loss and active heating should be used when possible. A warm air blanket is the most effective method of active heating. Radiant heat sources should be used with caution and placed such that the patient does not become overheated or burned.

In recovery, the animal should be dried thoroughly, as wet hair or wool will exacerbate heat loss. A hand-held hair dryer works well to dry small ruminants and calves postsurgery.

IX. INTRAOPERATIVE SUPPORT

A. Fluid Administration

General anesthesia affects fluid balance such that the ratio of infused fluids retained in the interstitial space increases dramatically (Connolly et al., 2003). Traditionally, crystalloid fluids have been administered, in large volumes, to surgical patients. While there are definite advantages of fluid administration in this setting, there are also disadvantages. Potential advantages of fluid administration include an increase in cardiac output and blood pressure with associated increases in oxygen delivery to tissues. However, excess fluid administration has been shown to increase morbidity and mortality in certain groups of critically hypotensive trauma patients of patients by impairing organ function (Watters et al., 2006).

Based on the data from human patients, it appears that for elective abdominal surgeries a crystalloid fluid rate of 4 ml/kg/h

is adequate (Nisanevich et al., 2005). Fluid volumes would need to be increased appropriately if hemorrhage occurs.

B. Support of Ventilation

The effects of the anesthetic drugs and the position of the animal depress ventilation in the anesthetized animal. In recumbency, the pressure of the abdominal viscera on the diaphragm reduces its movement. Hypoventilation is common during ruminant anesthesia and it is preferred to ventilate all anesthetized ruminants.

For most small ruminants and calves, a 1.5–2 L bellows is adequate. A tidal volume of 10–15 ml/kg is generally sufficient and a rate of 8–12 breaths/min is used. Adequacy of ventilation is facilitated by the use of a capnograph and ETCO_2 values are kept in the range of 30–40 mmHg. In recovery, ventilator support is maintained until the animal starts to breath spontaneously.

C. Treatment of Intraoperative Hypotension

Intraoperative hypotension occurs in all species, especially when inhalational anesthetics are used for maintenance of anesthesia. In adult horses, there is a strong correlation between intraoperative hypotension and the incidence of postoperative myopathy and the same is probably true for adult cattle. Hypotension may also arise secondary to hypovolemia and decreases in vascular resistance (see anterior epidural).

Initially, volume deficits should be corrected and the anesthetic plane should be lightened if the animal is deemed to be excessively deep. If the hypotensive state is secondary to anesthetic drug-induced myocardial depression, it should respond promptly to an inotrope. Dobutamine is a cardioselective inotrope with a wide dose range (0.5–5 $\mu\text{g}/\text{kg}/\text{min}$). Dobutamine is diluted in normal saline and given to effect.

X. ANALGESIA

Analgesic drugs most commonly used in ruminants include opioids, α_2 agonists, local anesthetics, and nonsteroidal anti-inflammatory drugs (NSAIDs), administered either alone or in various combinations. Routes of administration of these drugs can include IV, IM, epidural, local infiltration, and intra-articular. Analgesic techniques used in ruminants have been recently reviewed (Valverde and Doherty, in press; Valverde and Gunkel, 2005).

A. α_2 Agonists

In addition to the analgesic/sedative effects from systemic administration mentioned in previous sections of this chapter,

alpha₂ agonists can also be administered by the epidural route to provide analgesia (Table 14-4). Epidural administration results in marked analgesia to anesthesia of the perineum, hindlimbs, and abdomen. Systemic absorption also occurs as the doses used epidurally are similar to IM/IV doses and the absorption is considerable from the epidural space into the systemic circulation. Therefore, sedation and cardiorespiratory effects are similar to systemic use (Aminkov and Hubenov, 1995; Mpanduji et al., 2000). Paresis has been induced by xylazine but not other alpha₂ agonists (Aminkov and Hubenov, 1995).

B. Ketamine

Ketamine is now recognized as an analgesic drug at subanesthetic and anesthetic doses due to its inhibitory effects on the NMDA receptor. Subanesthetic doses have not been investigated in ruminants.

Epidural administration of doses of 1–2.5 mg/kg can provide short-lasting (30 minutes or less) dose-dependent analgesia in sheep, goats, and cattle. However, ataxia is common from these doses (Aithal et al., 1996; Guedes et al., 2006; Lee et al., 2003). Considering its short duration and side effect, this route is not practical.

C. Opioids

Opioids have been shown to be more effective in small ruminants than cattle. In sheep IV butorphanol, buprenorphine, fentanyl, and meperidine have proven effective in pain models against thermal and pressure stimulation (Nolan et al., 1987, 1988; Waterman et al., 1991a, 1991b) (Table 14-4). The behavioral changes from opioids are less common in animals requiring pain control; however, their side effects should be considered when selecting an opioid and the animal should be observed closely.

Epidural administration of (0.1 mg/kg diluted in sterile saline) at the sacrococcygeal or first coccygeal space in cattle and at the lumbosacral space in goats can result in analgesia of 6–12 hours duration of the perineal and abdominal area (Fierheller et al., 2004; George, 2003; Hendrickson et al., 1996; Pablo, 1993).

Alternative routes for morphine include intraarticular administration. Although it has not been described in ruminants, its use in dogs, horses, and humans is effective against inflammatory pain of the joint for at least 6 hours (Day et al., 1995). A dose of 0.05–0.1 mg/kg diluted with sterile saline (5–15 ml according to the joint size) can be used.

Transdermal fentanyl (50 µg/h) is effective in achieving higher than expected plasma fentanyl concentrations in goats due to the effects of the ruminosalivary cycle on the bioavailability of fentanyl. Therefore, animals should be observed for excessive sedation or signs of excitement (Carroll et al., 1999).

D. Lidocaine

The uses of lidocaine and other local anesthetics for local and regional anesthesia have been described in a previous section (Table 14-4). In addition, administration of IV lidocaine has become popular due to the systemic analgesic effects through its inhibitory actions on primary afferents A-delta and C fibers-evoked responses and spinal dorsal horn neurons, preferentially in painful conditions of visceral origin (Ness, 2000). Studies in other species have demonstrated dose-dependent reductions in MAC of inhalant anesthetics (Doherty and Frazier, 1998; Valverde et al., 2004). In goats, lidocaine at 2.5 mg/kg loading dose and 0.05–0.1 mg/kg/min decreased isoflurane MAC by 20% (Doherty et al., 2007).

E. Nonsteroidal Anti-Inflammatory Drugs

Phenylbutazone (2–6 mg/kg, PO, IV), flunixin (1–2 mg/kg, PO, IV), ketoprofen (2–3 mg/kg, PO, IV), and aspirin (100 mg/kg, PO) are the most commonly used NSAIDs in ruminants. Blockade of the cyclo-oxygenase (COX) enzymes by NSAIDs results in attenuation of inflammation and nociception by inhibiting the production of prostaglandins and reducing sensitization of nociceptors to noxious and non-noxious stimuli. Most of NSAIDs used in ruminants are COX inhibitors and do not spare the homeostatic effects of this enzyme on gastric and renal function. Therefore, they should be used cautiously and doses and frequency of administration should be within recommended ranges.

Although frequently used, analgesic effects of NSAIDs have not been thoroughly documented in ruminants. In addition, the use of phenylbutazone is prohibited by the FDA in dairy cattle 20 months of age or older due to its prolonged half-life and the risk of toxicity from its metabolites in humans (Haskell et al., 2003).

REFERENCES

- Abraham, W.M., Watson, H., Schneider, A., King, M., Yerger, L., and Sackner, M.A. (1981). Noninvasive ventilatory monitoring by respiratory inductive plethysmography in conscious sheep. *J. Appl. Physiol.* **51**, 1657–1661.
- Aithal, H.P., Amarpal, P.K., and Singh, G.R. (1996). Clinical effects of epidurally administered ketamine and xylazine in goats. *Small Rumin. Res.* **24**, 55–64.
- Aminkov, B.Y., and Hubenov, H.D. (1995). The effect of xylazine epidural anaesthesia on blood gas and acid–base parameters in rams. *Br. Vet. J.* **151**, 579–585.
- Angel, I., Niddam, R., and Langer, S.Z. (1990). Involvement of alpha-2 adrenergic receptor subtypes in hyperglycemia. *J. Pharmacol. Exp. Ther.* **254**, 877–882.
- Arnemo, J.M., and Soli, N.E. (1993). Chemical capture of free-ranging cattle: Immobilization with xylazine or medetomidine, and reversal with atipamezole. *Vet. Res. Commun.* **7**, 469–477.
- Aydin, F., Safak, C., Simsek, R., Erol, K., Ulgen, M., and Linden, A. (2006). Studies on condensed 1,4-dihydropyridine derivatives and their calcium modulatory activities. *Pharmazie* **61**, 655–659.

- Bernards, C.M., Kern, C., and Cullen, B.F. (1996). Chronic cocaine administration reversibly increases isoflurane minimum alveolar concentration in sheep. *Anesthesiology* **85**, 91–95.
- Blaze, C.A., LeBlanc, P.H., and Robinson, N.E. (1988). Effect of withholding feed on ventilation and the incidence of regurgitation during halothane anesthesia of adult cattle. *Am. J. Vet. Res.* **49**, 2126–2129.
- Bouchenafa, O., and Livingston, A. (1987). Autoradiographic localization of alpha-2 adrenoceptor binding sites in the spinal cord of sheep. *Res. Vet. Sci.* **42**, 382–386.
- Bovill, J.G. (2006). Intravenous anesthesia for the patient with left ventricular dysfunction. *Semin. Cardiothorac. Vasc. Anesth.* **10**, 43–48.
- Brett, C.M., Teitel, D.F., Heymann, M.A., and Rudolph, A.M. (1989). The young lamb can increase cardiovascular performance during isoflurane anesthesia. *Anesthesiology* **71**, 751–756.
- Cantalapiedra, A.G., Villanueva, B., and Pereira, J.L. (2000). Anaesthetic potency of isoflurane in cattle: Determination of the minimum alveolar concentration. *Vet. Anaesth. Analg.* **27**, 22–26.
- Carroll, G.L., Hartsfield, S.M., Champney, T.H., Geller, S.C., Martinez, E.A., and Harley, E.L. (2005). Effect of medetomidine and its antagonism with atipamezole on stress-related hormones, metabolites, physiologic responses, sedation, and mechanical threshold in goats. *Vet. Anaesth. Analg.* **32**, 147–157.
- Carroll, G.L., Hooper, R.N., Boothe, D.M., Hartsfield, S.M., and Randall, L.A. (1999). Pharmacokinetics of fentanyl after intravenous and transdermal administration in goats. *Am. J. Vet. Res.* **60**, 986–991.
- Celly, C.S., Atwal, O.S., McDonell, W.N., and Black, W.D. (1999). Histopathologic alterations induced in the lungs of sheep by use of alpha2-adrenergic receptor agonists. *Am. J. Vet. Res.* **60**, 154–161.
- Celly, C.S., McDonell, W.N., Black, W.D., and Young, S.S. (1997a). Cardiopulmonary effects of clonidine, diazepam and the peripheral α_2 adrenoceptor agonist ST-91 in conscious sheep. *J. Vet. Pharmacol. Ther.* **20**, 472–478.
- Celly, C.S., McDonell, W.N., Young, S.S., and Black, W.D. (1997b). The comparative hypoxaemic effect of four α_2 adrenoceptor agonists (xylazine, romifidine, detomidine and medetomidine) in sheep. *J. Vet. Pharmacol. Ther.* **20**, 464–471.
- Connolly, C.M., Kramer, G.C., Hahn, R.G., Chaisson, N.F., Svensen, C.H., Kirschner, R.A., Hastings, D.A., Chinkes, D.L., and Prough, D.S. (2003). Isoflurane but not mechanical ventilation promotes extravascular fluid accumulation during crystalloid volume loading. *Anesthesiology* **98**, 670–681.
- Davis, L.E., Neff-Davis, C.A., and Baggot, J.D. (1973). Comparative pharmacokinetics in domestic animals. In "Research Animals in Medicine." (L.T. Harmison, ed.), pp 715–732. Publication No. (NIH) 72-333. United States Department of Health, Education and Welfare, Washington, DC.
- Day, T.K., Pepper, W.T., Tobias, T.A., Flynn, M.F., and Clarke, K.M. (1995). Comparison of intra-articular and epidural morphine for analgesia following stifle arthroscopy in dogs. *Vet. Surg.* **24**, 522–530.
- de Haan, S., Greiser, M., Harks, E., Blaauw, Y., van Hunnik, A., Verheule, S., Allesie, M., and Schotten, U. (2006). AVE0118, blocker of the transient outward current (I_{to}) and ultrarapid delayed rectifier current (I_{Kur}), fully restores atrial contractility after cardioversion of atrial fibrillation in the goat. *Circulation* **114**, 1234–1242.
- Doherty, T.J., Ballinger, J.A., McDonell, W.N., Pascoe, P.J., and Valliant, A.E. (1987). Antagonism of xylazine induced sedation by idazoxan in calves. *Can. J. Vet. Res.* **51**, 244–248.
- Doherty, T.J., and Frazier, D.L. (1998). Effect of intravenous lidocaine on halothane minimum alveolar concentration in ponies. *Equine Vet. J.* **30**, 300–303.
- Doherty, T.J., Pascoe, P.J., McDonell, W.N., and Monteith, G. (1986). Cardiopulmonary effects of xylazine and yohimbine in laterally recumbent sheep. *Can. J. Vet. Res.* **50**, 517–521.
- Doherty, T.J., Redua, M.A., Queiroz-Castro, P., Egger, C.M., Cox, S.K., and Rohrbach, B.W. (2007). Effect of intravenous lidocaine and ketamine on the minimum alveolar concentration of isoflurane in goats. *Vet. Anesth. Analg.* **34**, 125–131.
- Doherty, T.J., Rohrbach, B.W., and Geiser, D.R. (2002). Effect of acepromazine and butorphanol on isoflurane minimum alveolar concentration in goats. *J. Vet. Pharmacol. Ther.* **25**, 65–67.
- Doherty, T.J., Will, W.A., Rohrbach, B.W., and Geiser, D.R. (2004). Effect of morphine and flunixin meglumine on isoflurane minimum alveolar concentration in goats. *Vet. Anaesth. Analg.* **31**, 97–101.
- Dunlop, C.I., Hodgson, D.S., Smith, J.A., Chapman, P.L., and Tyler, L.M. (1994). Cardiopulmonary effects of positioning pregnant cows in dorsal recumbency during the third trimester. *Am. J. Vet. Res.* **55**, 147–151.
- Dunlop, C.I., and Hoyt, R.F., Jr. (1997). Anesthesia and analgesia in ruminants. In "Anesthesia and Analgesia in Laboratory Animals." (D.F. Kohn, S.K. Wixson, W.J. White, and G.J. Benson, eds.), pp 281–311. Academic Press, Inc., San Diego, CA.
- Dyson, D., and Pettifer, G. (1997). Evaluation of the arrhythmogenicity of a low dose of acepromazine: Comparison with xylazine. *Can. J. Vet. Res.* **61**, 241–245.
- Ewaldsson, C.A., Vane, L.A., Kramer, G.C., and Hahn, R.G. (2006). Adrenergic drugs alter both the fluid kinetics and the hemodynamic responses to volume expansion in sheep. *J. Surg. Res.* **131**, 7–14.
- Fierheller, E.E., Caulkett, N.A., and Bailey, J.V. (2004). A romifidine and morphine combination for epidural analgesia of the flank in cattle. *Can. Vet. J.* **45**, 917–923.
- Gallivan, G.J., Bignell, W., McDonell, W.N., and Whiting, T.L. (1989). Simple nonbreathing valves for use with large mammals. *Can. J. Vet. Res.* **53**, 143–146.
- Garcia-Villar, R., Toutain, P.L., Alvinerie, M., and Ruckesbusch, Y. (1981). The pharmacokinetics of xylazine hydrochloride: An interspecific study. *J. Vet. Pharmacol. Ther.* **4**, 87–92.
- George, L.W. (2003). Pain control in food animals. In "Recent Advances in Anesthetic Management of Large Domestic Animals." (E.P. Steffey, ed.), International Veterinary Information Service (www.ivis.org), A0615.1103, Ithaca, NY. Accessed November 2006.
- Gilman, A.G. (1987). G proteins: Transducers of receptor-generated signals. *Ann. Rev. Biochem.* **56**, 615–649.
- Grant, C., and Upton, R.N. (2001). Cardiovascular and haemodynamic effects of intramuscular doses of xylazine in conscious sheep. *Aust. Vet. J.* **79**, 58–60.
- Greene, S.A. (2003). Protocols for anesthesia of cattle. *Vet. Clin. North Am. Food Anim. Pract.* **19**, 679–693.
- Gregory, G.A., Wade, J.G., Beihl, D.R., Ong, B.Y., and Sitar, D.S. (1983). Fetal anesthetic requirement (MAC) for halothane. *Anesth. Analg.* **62**, 9–14.
- Guedes, A.G., Pluhar, E., Daubs, B.M., and Rude, E.P. (2006). Effects of preoperative epidural administration of racemic ketamine for analgesia in sheep undergoing surgery. *Am. J. Vet. Res.* **67**, 222–229.
- Habel, R.E. (1975). Ruminant digestive system. In "Sisson and Grossman's—The Anatomy of the Domestic Animals." (R. Getty, ed.), 5th ed., pp 861–915. W.B. Saunders Co., Philadelphia, PA.
- Haerdi-Landerer, M., Schlegel, U., and Neiger-Aeschbacher, G. (2005). The analgesic effect of intrathecal xylazine and detomidine in sheep and their antagonism with systemic atipamezole. *Vet. Anaesth. Analg.* **32**, 297–307.
- Halmagyi, D.F.J., Starzecki, B., McRae, J., and Horner, G.J. (1963). The lung as the main target organ in the acute phase of transfusion reaction in sheep. *J. Surg. Res.* **3**, 418–429.
- Haskell, S.R.R., Gehring, R., Payne, M.A., Craigmill, A.L., Webb, A.I., Baynes, R.E., and Riviere, J.E. (2003). Update on FARAD food animal drug withholding recommendations. *J. Am. Vet. Med. Assoc.* **223**, 1277–1278.
- Hendrickson, D.A., Kruse-Elliot, K.T., and Broadstone, R.V. (1996). A comparison of epidural saline, morphine, and bupivacaine for pain relief after abdominal surgery in goats. *Vet. Surg.* **25**, 83–87.
- Hikasa, Y., Okuyama, K., Kakuta, T., Takase, K., and Ogasawa, S. (1998). Anesthetic potency and cardiopulmonary effects of sevoflurane in goats: Comparison with isoflurane and halothane. *Can. J. Vet. Res.* **69**, 89–92.
- Himmelseher, S., and Durieux, M.E. (2005). Ketamine for perioperative pain management. *Anesthesiology* **102**, 211–220.

- Hodgson, D.S., Dunlop, C.I., Chapman, P.L., and Smith, J.A. (2002). Cardiopulmonary effects of xylazine and acepromazine in pregnant cows in late gestation. *Am. J. Vet. Res.* **63**, 1695–1699.
- Hsu, W.H., Hanson, C.E., Hembrough, F.B., and Schaffer, D.D. (1989). Effects of idazoxan, tolazoline, and yohimbine on xylazine-induced respiratory changes and central nervous system depression in ewes. *Am. J. Vet. Res.* **50**, 1570–1573.
- Jansen, C.A., Lowe, K.C., and Nathanielsz, P.W. (1984). The effect of xylazine on intrauterine activity, fetal and maternal oxygenation, cardiovascular function and fetal breathing. *Am. J. Obstet. Gynecol.* **148**, 386–390.
- Jedruch, J., and Gajewski, Z. (1986). The effect of detomidine hydrochloride domosedan on the electrical activity of the uterus in cows. *Acta Vet. Scand.* **82**(Suppl.), 189–192.
- Kandel, R.A., Grynepas, M., Pilliar, R., Lee, J., Wang, J., Waldman, S., Zalzal, P., Hurtig, M., and CIHR-Bioengineering of Skeletal Tissues Team. (2006). Repair of osteochondral defects with biphasic cartilage-calcium polyphosphate constructs in a sheep model. *Biomaterials* **27**, 4120–4131.
- Kästner, S.B.R. (2006). A2-agonists in sheep: A review. *Vet. Anaesth. Analg.* **33**, 79–96.
- Kästner, S.B.R., Kull, S., Kutter, A.P.N., Boller, J., Bettschart-Wolfensberger, R., and Huhtinen, M.K. (2005). Cardiopulmonary effects of dexmedetomidine in sevoflurane-anesthetized sheep with and without nitric oxide inhalation. *Am. J. Vet. Res.* **66**, 1496–1502.
- Kay, R.N.B. (1960). The rate of flow and composition of various salivary secretions in sheep and calves. *J. Physiol.* **150**, 515–537.
- Kyles, A.E., Waterman, A.E., and Livingston, A. (1995). Antinociceptive activity of midazolam in sheep. *J. Vet. Pharmacol. Ther.* **18**, 54–60.
- Larenza, M.P., Bergadamo, A., Iff, I., Doherr, M.G., and Shatzmann, U. (2005). Comparison of the cardiopulmonary effects of anesthesia maintained by continuous infusion of ketamine and propofol with anesthesia maintained by inhalation of sevoflurane in goats undergoing magnetic resonance imaging. *Am. J. Vet. Res.* **66**, 2135–2141.
- LeBlanc, M.M., Hubbell, J.A., and Smith, H.C. (1984). The effects of xylazine hydrochloride on intrauterine pressure in the cow. *Theriogenology* **21**, 681–690.
- Lee, I., Yoshiuchi, T., Yamagishi, N., Oboshi, K., Ayukawa, Y., Sasaki, N., and Yamada, H. (2003). Analgesic effect of caudal epidural ketamine in cattle. *J. Vet. Sci.* **4**, 261–264.
- Leek, B.F. (1993). Digestion in the ruminant stomach. In “Dukes’ Physiology of Domestic Animals.” (M.J. Swenson, and W.O. Reece, eds.), 11th ed., pp 387–416. Comstock Publishing Associates, Ithaca, NY.
- Lin, H.C., and Riddell, M.G. (2003). Preliminary study of the effects of xylazine or detomidine with or without butorphanol for standing sedation in dairy cattle. *Vet. Ther.* **4**, 285–291.
- Lin, H.C., Thurmon, J.C., Benson, G.J., Tranquilli, W.J., and Olson, W.A. (1989). The hemodynamic response of calves to tiletamine-zolazepam anesthesia. *Vet. Surg.* **18**, 328–334.
- Lukasik, V.M., Nogami, W.M., and Morgan, S.E. (1998). Minimum alveolar concentration and cardiovascular effects of sevoflurane in sheep (abstract). *Vet. Surg.* **27**, A167.
- McGuirk, S.M., Bednarski, R.M., and Clayton, M.K. (1990). Bradycardia in cattle deprived of food. *J. Am. Vet. Med. Assoc.* **196**, 894–896.
- Mitchell, G.S., Smith, C.A., Vidruk, E.H., Jameson, L.C., and Dempsey, J.A. (1983). Effects of *p*-chlorophenylalanine on ventilatory control in goats. *J. Appl. Physiol.* **54**, 277–283.
- Mortola, J.P., and Lanthier, C. (2005). Breathing frequency in ruminants: A comparative analysis with non-ruminant mammals. *Respir. Physiol. Neurobiol.* **145**, 265–277.
- Mpanduji, D.G., Bittegeko, S.B.P., Mgasa, M.N., and Batamuzi, E.K. (2000). Analgesic, behavioural and cardiopulmonary effects of epidurally injected medetomidine (Domitor) in goats. *J. Vet. Med. A Physiol. Pathol. Clin. Med.* **47**, 65–72.
- Ness, T.J. (2000). Intravenous lidocaine inhibits visceral nociceptive reflexes and spinal neurons in the rat. *Anesthesiology* **92**, 1685–1691.
- Nisanevich V., Felsenstein, I., Almogy, G., Weissman, C., Einav, S., and Matot, I. (2005). Effect of intraoperative fluid management on outcome after intraabdominal surgery. *Anesthesiology* **103**, 25–32.
- Nolan, A., Livingston, A., and Waterman, A.E. (1987). Investigation of the antinociceptive activity of buprenorphine in sheep. *Br. J. Anaesth.* **92**, 527–533.
- Nolan, A., Waterman, A.E., and Livingston, A. (1988). The correlation of the thermal and mechanical antinociceptive activity of pethidine hydrochloride with plasma concentrations of the drug in sheep. *J. Vet. Pharmacol. Ther.* **11**, 94–102.
- O’Hair, K.C., Dodd, K.T., Phillips, Y.Y., and Beattie, R.J. (1988). Cardiopulmonary effects of nalbuphine hydrochloride and butorphanol tartrate in sheep. *Lab. Anim. Sci.* **38**, 58–61.
- Olsson, K., Hansson, A., Hydbring, E., von Walter, L.W., and Haggstrom, J. (2001). A serial study of heart function during pregnancy, lactation and the dry period in dairy goats using echocardiography. *Exp. Physiol.* **86**, 93–99.
- Pablo, L.S. (1993). Epidural morphine in goats after hindlimb orthopedic surgery. *Vet. Surg.* **22**, 307–310.
- Pablo, L.S., Bailey, J.E., and Ko, J.C.H. (1997). Median effective dose of propofol required for induction of anesthesia in goats. *J. Am. Vet. Med. Assoc.* **211**, 86–88.
- Prassinis, N.N., Galatos, A.D., and Raptopoulos, D. (2005). A comparison of propofol, thiopental or ketamine as induction agents in goats. *Vet. Anaesth. Analg.* **32**, 289–296.
- Queiroz-Castro, P., Egger, C.M., Redua, M.A., Rohrbach, B.W., and Doherty, T.J. (2006). Effects of ketamine and magnesium on the minimum alveolar concentration of isoflurane in goats. *Am. J. Vet. Res.* **6**, 1962–1966.
- Ranheim, B., Horsberg, T.E., Soli, N.E., Ryeng, K.A., and Arnemo, J.M. (2000). The effects of medetomidine and its reversal with atipamezole on plasma glucose, cortisol and noradrenaline in cattle and sheep. *J. Vet. Pharmacol. Ther.* **23**, 379–387.
- Reid, J., Nolan, W., and Welsh, E. (1993). Propofol as an induction agent in the goat: A pharmacokinetic study. *J. Vet. Pharmacol. Ther.* **16**, 488–493.
- Reinhold, P., Rabeling, B., Gunther, H., and Schimmel, D. (2002). Comparative evaluation of ultrasonography and lung function testing with the clinical signs and pathology of calves inoculated experimentally with *Pasteurella multocida*. *Vet. Rec.* **150**, 109–114.
- Rezakhani, A., Edjehadi, M., and Szpuniewicz, M. (1977). Prevention of thiopental and halothane cardiac sensitization to epinephrine in the sheep. *Can. J. Comp. Med.* **41**, 389–395.
- Rioja, E., Kerr, C., Enouri, S., and McDonell, W. (2006). Effect of atipamezole on cardiovascular and respiratory changes induced by xylazine and medetomidine in calves (abstract). In “Proceedings of the 31st Annual Meeting of the ACVA.” Chicago, IL.
- Rioja, E., Kerr, C.L., Enouri, S.S., and McDonell, W.N. (2008). Sedative and cardiopulmonary effects of medetomidine hydrochloride and xylazine hydrochloride and their reversal with atipamezole hydrochloride in calves. *Am. J. Vet. Res.* **69**, 319–329.
- Rosenberg, P.H., Veering, B.T., and Urmev, W.F. (2004). Maximum recommended doses of local anesthetics: A multifactorial concept. *Reg. Anesth. Pain Med.* **29**, 564–575.
- Sakamoto, H., Misumi, K., Nakama, M., and Aoki, Y. (1996). The effects of xylazine on intrauterine pressure, uterine blood flow, maternal and fetal cardiovascular and pulmonary function in pregnant goats. *J. Vet. Med. Sci.* **58**, 211–217.
- Schmitz-Rode, T., Verma, R., Pfeffer, J.G., Hilgers, R.D., and Gunther, R.W. (2006). Temporary pulmonary stent placement as emergency treatment of pulmonary embolism: First experimental evaluation. *J. Am. Coll. Cardiol.* **48**, 812–816.
- Schwab, M., Coksaygan, T., Samtani, M.N., Jusko, W.J., and Nathanielsz, P.W. (2006). Kinetics of betamethasone and fetal cardiovascular adverse effects in pregnant sheep after different doses. *Obstet. Gynecol.* **108**, 617–625.
- Sessler, D.I., Sten, R., Lofsson, C.I., and Chow, F. (1989). Lower esophageal contractility predicts movement during skin incision in patients anesthetized

- with halothane, but not with nitrous oxide alfentanil. *Anesthesiology* **70**, 42–46.
- Simsek, R., Safak, C., Erol, K., and Sirmaçul, B. (2001). Studies on calcium antagonist activities of 2-ethyl-3-carbomethoxy-4-aryl-5-oxo-6,6-dimethyl-1,4,5,6,7,8-hexahydroquinoline derivatives. *Arzneimittelforschung* **51**, 959–963.
- Skarda, R.T., Jean, G.S., and Muir, W.W. III. (1990). Influence of tolazoline on caudal epidural administration of xylazine in cattle. *Am. J. Vet. Res.* **51**, 556–560.
- Skarda, R.T., and Muir, W.W. (1982). Hemodynamic and respiratory effects of segmental subarachnoid analgesia in adult Holstein cows. *Am. J. Vet. Res.* **43**, 1343–1348.
- Steffey, E.P. (1986). Some characteristics of ruminant and swine that complicate management of general anesthesia. *Vet. Clin. North Am. Food Anim. Pract.* **2**, 507–516.
- Steffey, E.P., and Howland, D., Jr. (1979). Halothane anesthesia in calves. *Am. J. Vet. Res.* **40**, 372–376.
- Stegmann, G.F. (1998). Observations on the use of midazolam for sedation, and induction of anaesthesia with midazolam in combination with ketamine in the goat. *J. S. Afr. Vet. Assoc.* **69**, 89–92.
- Suzuki, K., Suzuki, T., Miyahara, M., Iwabuchi, S., and Asano, R. (2005). Comparison of a small volume of hypertonic saline solution and dextran 40 on hemodynamic alterations in conscious calves. *J. Vet. Sci.* **6**, 111–116.
- Thompson, J.R., Hsu, W.H., and Kersting, K.W. (1989). Antagonistic effect of idazoxan on xylazine-induced central nervous system depression and bradycardia in calves. *Am. J. Vet. Res.* **50**, 734–736.
- Thompson, J.R., Kersting, K.W., and Hsu, W.H. (1991). Antagonistic effect of atipamezole on xylazine-induced sedation, bradycardia, and ruminal atony in calves. *Am. J. Vet. Res.* **52**, 1265–1268.
- Thurmon, J.C. (1986). Anesthesia in ruminants and swine. *Vet. Clin. North Am. Food Anim. Pract.* **2**, 567–591.
- Timek, T.A., Lai, D.T., Dagum, P., Liang, D., Daughters, G.T., Ingels, N.B., Jr., and Miller, D.C. (2006). Mitral leaflet remodeling in dilated cardiomyopathy. *Circulation* **114**(I Suppl.), 1518–1523.
- Törneke, K., Bergström, U., and Neil, A. (2003). Interactions of xylazine and detomidine with α_2 -adrenoceptors in brain tissue from cattle, swine and rats. *J. Vet. Pharmacol. Ther.* **26**, 205–211.
- Valverde, A., Doherty, T.J., Dyson, D., and Valliant, A.E. (1989). Evaluation of pentobarbital as a drug for standing sedation in cattle. *Vet. Surg.* **18**, 235–238.
- Valverde, A., Doherty, T.J., Hernández, J., and Davies, W. (2004). Effect of lidocaine on the minimum alveolar concentration of isoflurane in dogs. *Vet. Anaesth. Analg.* **31**, 264–271.
- Valverde, A., and Doherty, T.J. (2008). Pain management in cattle and small ruminants. In “Current Veterinary Therapy Food animal Practice.” (D. Anderson, M. Rings, eds.) 5th ed. Saunders, St. Louis. (in press)
- Valverde, A., and Gunkel, C. (2005). Pain management in horses and farm animals. *J. Vet. Emerg. Crit. Care* **15**, 295–307.
- Viateau, V., Guillermin, G., Calando, Y., Logeart, D., Oudina, K., Sedel, L., Hannouche, D., Bousson, V., and Petite, H. (2006). Induction of a barrier membrane to facilitate reconstruction of massive segmental diaphyseal bone defects: An ovine model. *Vet. Surg.* **35**, 445–452.
- Virtanen, R., Savola, J.M., Saano, V., and Nyman, L. (1988). Characterization of the selectivity, specificity and potency of medetomidine as an α_2 -adrenoceptor agonist. *Eur. J. Pharmacol.* **150**, 9–14.
- Waterman, A.E., Livingston, A., and Amin, A. (1991a). Analgesic activity and respiratory effects of butorphanol in sheep. *Res. Vet. Sci.* **51**, 19–23.
- Waterman, A.E., Livingston, A., and Amin, A. (1991b). Further studies on the antinociceptive activity and respiratory effects of buprenorphine in sheep. *J. Vet. Pharmacol. Ther.* **14**, 230–234.
- Watters, J.M., Tieu, B.H., Todd, S.R., Jackson, T., Muller, P.J., Malinoski, D., and Schreiber, M.A. (2006). Fluid resuscitation increases inflammatory gene transcription after traumatic injury. *J. Trauma* **61**, 300–308.
- Winkler, G.C. (1988). Pulmonary intravascular macrophages in domestic animal species: Review of structural and functional properties. *Am. J. Anat.* **181**, 217–234.

This page intentionally left blank

Chapter 15

Anesthesia and Analgesia in Swine

Alison C. Smith and M. Michael Swindle

I. Introduction	414
II. Breed, Anatomic, and Physiologic Characteristics	414
III. Anesthetic Delivery	415
IV. Inhalational Anesthesia	417
A. Nitrous Oxide	417
B. Isoflurane	417
C. Sevoflurane	418
D. Desflurane	418
V. Injectable Anesthetics and Tranquilizers	419
A. Tranquilizers, Sedatives, and Anticholinergics	419
B. Dissociative Agents	420
C. Barbiturates	421
D. Opioid Infusions and Combinations	421
E. Miscellaneous Injectables	422
VI. Regional Analgesia	422
VII. Analgesia	423
VIII. Intraoperative Monitoring and Support	423
IX. Cardiac Arrhythmias	424
X. Support	424
XI. Postsurgical Care	425
XII. Special Anesthetic Considerations	425
A. Malignant Hyperthermia (MH)	425
B. Recognition of MH	425
C. Triggering Agents	426
D. Prevention and Management of MH	426
E. Treatment and Management of the MH Crisis	426
XIII. Cardiopulmonary Bypass	426
A. Fundamentals and Description of CPB	427
B. Choice of Priming Solutions	427
C. Myocardial Protection	428
D. Anticoagulation	428
E. Arterial Pump Flow Rates (APFR)	428
F. Measurement and Monitoring During CPB	428
G. Central Venous Pressure (CVP)	429
H. Left Atrial and Pulmonary Wedge Pressure (LA & PWP) Measurement	429

I. Termination of CPB or “Weaning off the Pump”	429
J. Anesthetic Management	430
K. Anesthesia for Normal (MH-Free) Pigs for CPB	430
L. CPB Anesthesia for MH Positive Pigs	430
M. Recent Developments in CPB in Swine	431
XIV. Summary and Additional Reference Material	431
Appendix Tables	432
A1: Dissociative Anesthetics and Combinations	432
A2: Tranquilizers, Hypnotics, and Sedatives	433
A3: Miscellaneous Anesthetic and Perioperative Drugs	434
A4: NSAID and Opioid Analgesics	434
A5: Protocol for Routine Surgery without Physiologic Measurements	435
A6: Protocol for Nonsurvival Teaching Laboratories	435
A7: Opioid Infusion Protocol for Cardiopulmonary Bypass with Cardiac Compromise	435
A. Websites	436
References	436

I. INTRODUCTION

This chapter is an updated version of the book chapter on porcine anesthesia that was written for the first edition of this textbook. In the first edition, the submission on cardiopulmonary bypass (CPB) and malignant hyperthermia (MH) was written by William J. Ehler, DVM. He is not a coauthor on this version of the chapter; however, his original submission is retained mostly intact with updates from the literature.

Since the publication of the first edition of the textbook, a significant amount of information concerning the use of swine in biomedical research has been published. This includes several textbooks on swine in research (Bollen et al., 2000; Pond and Mersmann, 2001; Swindle, 1998, 2007; Tumbleson and Schook, 1996) and reference books on laboratory animal anesthesia and analgesia which include swine (Flecknell, 1996; Hawk et al., 2005).

II. BREED, ANATOMIC, AND PHYSIOLOGIC CHARACTERISTICS

When using swine in research, the investigator should take into consideration that differences exist between domestic (commercial farm breeds) and miniature swine, as well as between breeds within both categories, even though all are classified as *Sus scrofa domestica*. Within the same breed and type of pig, differences related to age, weight, and sex may become apparent. Genetically, there may be differences between sources of the same breed and, many times, domestic swine are crossbreeds. All these factors must be taken into consideration when considering the physiologic effects of an anesthetic agent during an experiment (Swindle, 2007).

Miniature breeds are more mature than domestic swine at the same body weight. For example, at 12 weeks of age the comparative body weights of various types of pigs would be expected

to be: Yucatan miniature pig—15 kg; Yucatan micropig—12 kg; Hanford miniature pig—19 kg; and a Yorkshire domestic pig—36 kg. Both miniature and domestic pigs achieve sexual maturity between 4 and 6 months of age. If the same pigs are compared at 6 months of age, the comparative body weights would be expected to be even more diverse with a weight range of over 70 kg. Consequently, matching miniature and domestic stocks of pigs by body weight to compare pharmacologic actions could be misleading because of the potential age differences. When considering the hemodynamic effects of anesthetics on studies using different stocks, it is not appropriate to compare the pigs by body weight without indexing to body surface area (Smith et al., 1990; Swindle, 2007).

Within the same stock, differences in response to anesthetics can be age related (Buckley et al., 1979; Crane et al., 1975; Gootman et al., 1986). In a study comparing the differences in various parameters among three stocks of miniature pigs, all of which were 4 months of age, significant differences were found between the heart weight:body weight ratio, peak systolic pressure, right ventricular peak pressure, mean arterial pressure, right atrial pressure, mean pulmonary artery pressure (PAP), and pulmonary vascular resistance when using equivalent anesthetic conditions (Smith et al., 1990).

In a European study, comparing Gottingen and Yucatan miniature pigs with farm pigs in an acute cardiovascular protocol, only minor differences between stocks were found when they were weight matched at 20–25 kg. The farm pigs tended to develop dysrhythmias and have a shorter stabilization period than either of the miniature breeds. The Yucatan had higher absolute hemodynamic values. For their studies, these differences were considered insignificant (Benharkate et al., 1993).

Consequently, comparisons of the response to various anesthetic agents in swine should be made with caution when the experimental animals are not of the same stock, age, and weight (Buckley et al., 1979; Smith et al., 1990; Swindle, 2007).

Swine are prone to vasospasm and many of the peripheral vessels are not readily visualized, which may make vascular

access difficult for inexperienced personnel. Swine are also highly susceptible to ventricular arrhythmias, have fragile pulmonary tissue which may be damaged by over-inflation with mechanical respirators, and have a left hemizygous vein which drains the intercostal vessels into the coronary sinus. All these factors should be considered when selecting anesthetic agents and their method of delivery to swine (Bobbie and Swindle, 1986; Smith et al., 1989; Swindle, 2007; Swindle et al., 1986, 1988).

III. ANESTHETIC DELIVERY

The most reliable sites for vascular access and injections of anesthetics in laboratory swine have been previously reviewed and illustrated (Bobbie and Swindle, 1986; Swindle, 2007; Swindle, 1983). Intramuscular (IM) injections may be given in the major muscles of the thigh and in the neck. The semimembranous and semitendinosus muscles of the caudal thigh as well as the gluteal muscles of the cranial thigh are both acceptable sites for giving large-volume IM injections. The muscle mass of the dorsolateral neck region is a good site for small-volume injections.

Subcutaneous (SC) injections may be given in the neck or in the flank. The pig is a fixed-skin animal, like humans, and does not have a SC region as large or accessible as other animal species. By experience we have found that the anesthetic and analgesic agents that are labeled for IM injection can be given SC. SC injections in the neck are less painful than IM injections with the same agents. The method of delivering a SC or IM injection with a butterfly catheter is described below.

The peripheral blood vessels are not easily visualized in most pigs. The ear veins are the most common site for intravenous (IV) injections. The veins are located on the lateral and medial dorsal ear margins and the artery is centrally located.

The cephalic vein is located on the cranial aspect of the foreleg between the carpus and the elbow joint, is readily accessible, and can be palpated if a tourniquet is placed around the elbow joint. If blood flow through the vessel is occluded by the thumb and if the skin is rotated laterally, as is commonly done in the dog, the vessel will collapse and become inaccessible. The cephalic vein also crosses the medial aspect of the shoulder and can be distended in dorsal recumbency by putting digital pressure on the thoracic inlet.

In the rear leg the lateral and median saphenous veins are generally unreliable for anesthetic delivery because of their small size. The femoral vessels may be approached percutaneously but are more frequently used for vessel cannulation following surgical exposure.

The external jugular veins are deep in the pig and lie in the same plane as the internal jugular veins and carotid arteries. These vessels are best used for surgical cannulation or blood sampling and would probably only be used in an emergency situation for anesthetic delivery. The cranial vena cava may be



Fig. 15-1 Pig in a humane restraint sling being induced under anesthesia with a face mask.

cannulated by inserting a needle into the thoracic inlet at the midpoint of an imaginary line between the point of the scapulo-humeral joint and the manubrium sterni with the needle angled toward the midline.

Restraint of the pig for injections or for delivery of inhalant anesthetics via face mask may be very stressful. A humane restraint sling (Fig. 15-1) has been described (Panepinto et al., 1983) and variations of the method have been developed by individual laboratories (Haupt, 1986; Swindle, 2007). This restraint method is comfortable for the pig and most will readily accept suspended restraint after a few training sessions. Manual restraint by suspending the pig by the rear legs, use of snout snares, or tying to a V-trough is stressful and should be discouraged. Small pigs may be manually restrained and larger pigs may be herded into the corner of a pen using a panel.

Small needle sizes (20–22 g) can be used for most animals for IV, IM, or SC injections. Large-gauge needles (14–16 g) used for venipuncture in domestic farm breeds are unnecessary and contraindicated in animals <60 kg. Teflon-coated catheters may lose their outer covering when being passed through the skin unless the skin is incised. As an alternative, polyethylene intravascular catheters or butterfly catheters may be used. IM or SC injections may be given by positioning a butterfly catheter into the injection site with a quick open-handed slap technique while holding the wings of the butterfly between two fingers. The catheter is connected to a length of extension tubing, which, in turn, is attached to a syringe. The neck of the pig is lightly slapped with the hand several times prior to inserting the needle. While simultaneously administering a slap, the needle is inserted. The pig will generally not notice the catheter and the injection can be administered without manual restraint.

Some of the chemical restraint methods discussed in this chapter may be necessary to reduce stress in swine prior to handling, venipuncture, or other invasive techniques such as catheterization. If combination injections are being used, administration of the tranquilizer/sedative drug separately may help reduce the stress. For example, if you are using ketamine and acepromazine, administration of the acepromazine 5–10 minutes prior to ketamine may reduce the stress associated with the more irritating ketamine injection.

A simple method of endotracheal intubation has been described for swine under 50 kg (Swindle, 2007). Swine are placed in dorsal recumbency and the epiglottis is visualized using a straight laryngoscope blade (Figs. 15-2, 15-3, 15-4, 15-5, and 15-6). A topical anesthetic, i.e., lidocaine, is sprayed on the larynx as prophylaxis against laryngospasm. The tip of the epiglottis is depressed with the tip of the laryngoscope against the base of the tongue, and firm pressure with the blade of the laryngoscope presses the maxilla against the surface of the table.

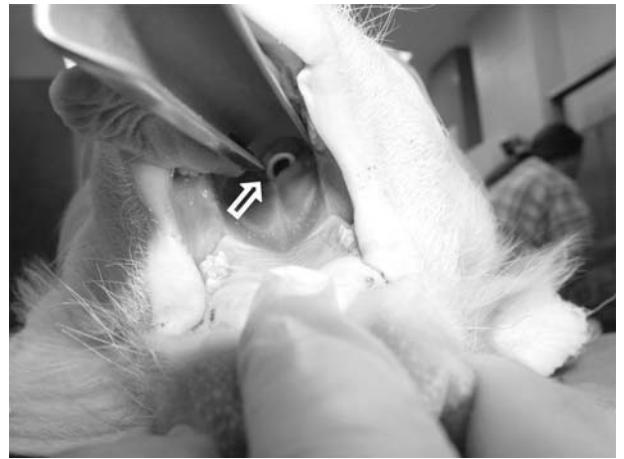

Fig. 15-4 View of the oral cavity after the epiglottis (arrow) has been displaced from the hard palate.



Fig. 15-2 Equipment and supplies for intubation of a pig.

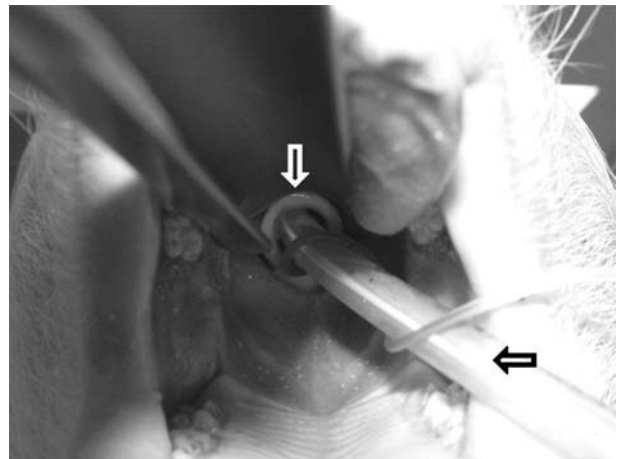

Fig. 15-5 View of the epiglottis (white arrow) after the endotracheal tube (black arrow) has been passed into the larynx.



Fig. 15-3 Position of the pig for endotracheal intubation in dorsal recumbency.



Fig. 15-6 The endotracheal tube has had the cuff inflated, been taped to the maxilla and connected to the gas anesthesia machine.

With the laryngoscope blade at a 45° angle, the larynx can now be visualized as it is pressed against the ventral surface of the neck and the vocal cords can be visualized by looking down the path of the blade. The tip of the endotracheal tube is passed into the larynx while still being visualized. Once the tube is at the larynx further passage may be obstructed by the laryngeal diverticulum, which can be easily traumatized by the tube. Passage may be facilitated by gently rotating the tube 90° while simultaneously applying forward pressure. This forward corkscrew motion should facilitate passage without undue force.

When using this method, it is contraindicated to have an assistant hold the jaw open because this causes the laryngeal–tracheal passage to bend at an angle that makes intubation difficult. Inexperienced anesthetists may find stylets to be helpful, but they are generally unnecessary. A standard laryngoscope blade with a length of less than 195 mm is usually indicated. An endotracheal tube of 5–8 mm internal diameter and 22–30 cm long can be used for swine under 50 kg. If more than minor force is required to pass the tube, then either the tube is too large or else the angle of the laryngoscope blade is less than 45°.

The more conventional method of placing pigs in sternal recumbency and using specialized laryngoscopes and assistants to hold the mouth open is generally necessary in swine over 50 kg of body weight. In this case, modification of the laryngoscopes for extra length may be necessary. Endotracheal tubes, 9–14 mm internal diameter, are recommended for swine over 50 kg.

IV. INHALATIONAL ANESTHESIA

The older inhalational anesthetic agents such as halothane, methoxyflurane, and enflurane should be discontinued as anesthetics in research protocols. They are not as effective as the newer agents and also have significant human health issues associated with their use. The two primary agents used nowadays are isoflurane and sevoflurane with a lesser usage of desflurane.

A. Nitrous Oxide

Use of nitrous oxide as a sole anesthetic agent in swine, as in other animal species, is contraindicated because its low potency results in the inability to maintain a surgical plane of anesthesia. Issues concerning human exposure, diffusion hypoxia during recovery, and diffusion into gas-filled spaces need to be considered when using this agent.

The minimum alveolar concentration (MAC) for nitrous oxide in swine is 195 volume % (Tranquilli et al., 1985), similar to nitrous oxide MAC in other species (Steffey and Eger, 1985). Although Eisele et al. (1985) reported a lower value of 162 volume % for nitrous oxide MAC, both studies documented a quantitative difference between man and swine in the ability of nitrous oxide to decrease the requirement for a concomitantly

administered anesthetic agent. In swine, the combination of nitrous oxide and halothane or isoflurane causes less cardiovascular depression than equipotent levels of either agent used alone (Lundeen et al., 1983; Manohar and Parks, 1984a–c).

The primary advantage of using nitrous oxide is derived from the ability to reduce the requirement of other volatile anesthetics resulting in less cardiovascular depression than when greater concentrations of these agents are used alone with oxygen. However, because of its lower potency in swine, the reduction in the requirement of other volatile agents is not as great as in man. Use of nitrous oxide combined with oxygen in a 1/2:2/3 ratio of nitrous oxide to oxygen will significantly reduce the amount of the inhalant anesthetic required, which may be appropriate for some protocols (Swindle, 2007).

B. Isoflurane

Isoflurane MAC values for young swine of the age commonly used in research range from 1.45% (Lundeen et al., 1983) to 2.04% (Eger et al., 1988) with an average MAC value of 1.58% (Greene et al., 2004). Variations in reported values can be attributed to differences in experimental methodologies, age and breeds of swine, and body temperature. The reported MAC value for neonatal piglets ranging in age from 2 days to 17 days is 1.2% (Schieber et al., 1986).

Isoflurane has a wide margin of cardiovascular safety (Weiskopf et al., 1989a, 1989b). Isoflurane produces a dose-dependent depression of the cardiovascular system characterized by decreases in aortic pressure, cardiac output, and stroke volume. However, when compared to older agents the depressant effects of isoflurane are less and occur at higher anesthetic concentrations (Gilbert et al., 1989). Use of nitrous oxide as an adjunct to isoflurane anesthesia maintains heart rate, cardiac output, and rate-pressure product, an indicator of myocardial oxygen uptake, near values for conscious animals (Lundeen et al., 1983). Myocardial blood flow is decreased in a dose-related manner, especially in the endocardium. However, the ratio of endocardial to epicardial perfusion remains near 1 (Manohar and Parks, 1984).

The hemodynamic changes produced by isoflurane are more profound in newborn piglets (2–17 days) than in more mature animals. Like human infants, neonatal piglets develop moderate-to-severe bradycardia and marked hypotension with preservation of cardiac output. The neonatal response has been attributed to the imbalance in the state of development of the autonomic nervous system characterized by a well-developed parasympathetic nervous system and an immature sympathetic nervous system. While the margin of safety for isoflurane in neonatal swine is relatively low, it is greater than that for equipotent concentrations of halothane because it better preserves cardiac output (Schieber et al., 1986).

The scientific literature is conflicting regarding the effects of isoflurane on the coronary circulation (Priebe, 1989). Much

of the confusion may be due to differences in methodology as well as species differences in coronary anatomy and pathophysiology (Cheng et al., 1992). While there is evidence that isoflurane causes direct coronary vasodilation (Gilbert et al., 1988), there is no convincing evidence that isoflurane, in swine with a normal coronary circulation, impairs myocardial oxygenation (Priebe, 1989). The contribution of isoflurane to myocardial ischemia by the mechanism of coronary steal in human patients with coronary artery disease will probably continue to be debated. Experimental and clinical evidence suggests that isoflurane is potentially dangerous to a subset of patients with coronary artery disease and "steal-prone" coronary anatomy (Priebe, 1989). Results of recent studies in a swine model of collateral-dependent myocardium indicate that neither isoflurane nor halothane at clinically useful concentrations produced myocardial ischemia by either intercoronary or transmural redistribution of regional myocardial blood flow (Cheng et al., 1992).

Compared to halothane, significantly greater infusion rates of epinephrine are required to induce cardiac dysrhythmias in isoflurane-anesthetized swine (Weiskopf et al., 1989). Unlike enflurane, isoflurane does not produce seizure activity (Rampil et al., 1988).

Isoflurane, compared to halothane, administered in 50% nitrous oxide and oxygen for swine undergoing liver transplantation was associated with higher intraoperative blood pressures, shorter anesthetic recovery times, and better long-range survival (Eisele et al., 1986). In miniature swine, hepatic metabolism occurred at low alveolar concentrations of halothane but not with isoflurane (Halsey et al., 1971). In swine undergoing laparotomy, the administration of either isoflurane or fentanyl in concentrations that decreased mean arterial pressure by $\leq 30\%$ provided adequate hepatic oxygen supply. Halothane, at concentrations that produced a similar degree of hypotension, or isoflurane concentrations producing decreases in blood pressure exceeding 30% were associated with inadequate hepatic oxygen supply (Gelman et al., 1987).

Isoflurane does not cause hepatic injury. Determinations of plasma alanine aminotransferase (ALT), an indicator of hepatocellular necrosis, were not increased over baseline values after prolonged isoflurane anesthesia in swine (Holmes et al., 1990). Although isoflurane administration results in a three-fold increase in concentrations of plasma fluoride ions, the degree of biotransformation is minimal and not associated with renal toxicity (Koblin et al., 1989).

Given the many advantageous properties of isoflurane, it should be considered as the inhalation agent of choice for swine at this time.

C. Sevoflurane

Sevoflurane is similar in characteristics to isoflurane; however, it may be safer for high-risk patients. The hemodynamic

effects and visceral organ perfusion characteristics of sevoflurane are analogous to those of isoflurane, with the exception of decreased cerebral blood flow at 1–1.5 MAC (Manohar and Parks, 1984). The cerebral blood flow response is the opposite of that which occurs with isoflurane, nitrous oxide, and most other inhalant agents, which may give it an advantage in neuroanesthesia (Holmström et al., 2004). There are dose-related depressions of cardiac output, stroke volume, mean aortic pressure, and left ventricular work without an increase in heart rate (Manohar and Parks, 1984). It has no appreciable effects upon the pressure relationships associated with hypoxic or hyperoxic pulmonary vasoconstriction (Kerbaul et al., 2000). It has a MAC value of approximately 2.66%, which results in rapid induction and recovery when using it as a sole agent in isocapnic pigs (Manohar and Parks, 1984; Martin-Cancho et al., 2003; Martin-Cancho et al., 2004; Natalini, 2001).

Sevoflurane concentration required for anesthesia is reduced with administration of nitrous oxide (50–70%) or xenon (15–60%) in a linear fashion (Hecker et al., 2003; Manohar and Parks, 1984). Sevoflurane is metabolized at approximately 3% as compared to isoflurane and desflurane, which are metabolized <1% (Natalini, 2001).

Sevoflurane should be considered as the primary alternative to isoflurane especially in cases involving depressed hemodynamics or neurological procedures.

D. Desflurane

Experimental studies with chronically instrumented swine have been utilized to obtain data regarding the anesthetic effects of desflurane. The effects of desflurane in swine appear to be similar to those in humans (Weiskopf et al., 1992). Desflurane is pungent which makes mask induction more difficult.

The MAC for desflurane in swine, determined by using the tail-clamp technique, was 8.28%. A more consistent and higher MAC value of 10.00% was obtained by clamping the dewclaw. The difference in MAC values was attributed to the difference in the type of stimulus applied and the use of the tail-clamp technique underestimated the anesthetic requirement of pigs because it was not a supramaximal stimulus (Eger et al., 1988). The same authors later determined the MAC value for desflurane in humans to be 7%, which correlated with the observation that the MAC values for other anesthetic agents in swine are higher than those in humans (Weiskopf et al., 1992). The cardiovascular effects of desflurane in swine are similar to those of isoflurane, producing vasodilation, hypotension, and dose-dependent myocardial depression. The cardiovascular effects of desflurane were studied at 0.8, 1.2, and 1.6 MAC and compared with the data obtained while the animals were conscious and with equipotent concentrations of isoflurane. Desflurane produced decreases in mean arterial blood pressure and stroke volume in a dose-related manner despite increases in right-

and left-heart filling pressures and a dose-dependent decrease in systemic vascular resistance (SVR). Heart rate increased above the conscious state at 0.8 MAC, while cardiac output was unchanged. At higher concentrations the heart rate decreased but remained greater than that of conscious animals. However, concentrations above 0.8 MAC caused a dose-dependent decrease in cardiac output despite increased right- and left-heart preload. Dose-dependent decreases in oxygen consumption and left ventricular minute work, calculated as the product of systolic blood pressure, cardiac output and a rate constant, were also observed (Armbruster et al., 1997; Karzai et al., 1997; Weiskopf et al., 1988).

The margin of safety for desflurane, defined as the ratio of fatal anesthetic concentration to MAC, is between that of isoflurane and other halogenated anesthetics. High concentrations of desflurane, similar to isoflurane, result in a progressive decrease in mean aortic pressure and cardiac output without affecting heart rate. However, neither parameter was a useful indicator of impending cardiovascular collapse. The most useful indices of imminent cardiovascular collapse were decreases in mixed venous PO₂, mixed venous oxyhemoglobin saturation, and the ratio of oxygen transport to oxygen consumption, which occurred within 0.5 MAC of the fatal anesthetic concentration (Weiskopf et al., 1989).

Desflurane anesthesia does not produce adverse cardiovascular effects combined with the commonly used anesthetic adjuncts atropine, succinylcholine, atracurium, fentanyl, thiopental, naloxone, and nitrous oxide (Weiskopf et al., 1990). Desflurane does not lower the myocardial threshold for epinephrine-induced dysrhythmias (Weiskopf et al., 1989).

Prolonged anesthesia with desflurane does not produce hepatic injury. Plasma ALT levels were determined before anesthesia, at the end of anesthesia, and 3–8 days after exposure to either desflurane or isoflurane. ALT activity was never increased above baseline levels at any time nor were there differences between the hepatic effects of isoflurane and desflurane (Holmes et al., 1990).

Desflurane undergoes little to no metabolism. Plasma fluoride concentration is used as an index of desflurane metabolism. At the end of a total dose of 5.4 MAC hours of desflurane anesthesia, plasma fluoride concentration did not change. A 17% increase in plasma fluoride concentration occurred 4 hours after anesthesia, but this level was markedly below that associated with subclinical renal toxicity (Koblin et al., 1989).

Desflurane has been identified as a trigger for MH in those breeds that are susceptible (Wedel et al., 1991). It has also been demonstrated to cause higher cerebral blood flow and intracranial pressure than isoflurane or sevoflurane (Holmström et al., 2004).

Given its similarity in anesthetic effects and the substantially greater cost of desflurane compared to that of isoflurane, its choice over isoflurane, currently, cannot be justified. Desflurane also requires an electrically heated, pressurized vaporizer for delivery.

V. INJECTABLE ANESTHETICS AND TRANQUILIZERS

A. Tranquilizers, Sedatives, and Anticholinergics

The phenothiazine derivative tranquilizers are acceptable for sedation either as a sole agent or combined with anesthetics. Acepromazine (0.11–1.1 mg/kg IM, IV, SC) (Benson and Thurmon, 1979; Gross, 2001; Riebold and Thurmon, 1986; Swindle, 2007; Swindle and Bobbie, 1983) is the most commonly used agent in this class, although dosages have been reported for promazine (0.44–2.0 mg/kg IM, IV, SC) (Benson and Thurmon, 1979; Bolin and Runnels, 1992; Riebold and Thurmon, 1986; Swindle and Bobbie, 1983) and chlorpromazine (0.5–4 mg/kg IM, IV, SC) (Benson and Thurmon, 1979; Bolin and Runnels, 1992; Riebold and Thurmon, 1986; Swindle and Bobbie, 1983). This class of tranquilizers produces an alpha-adrenergic blockade in higher doses, which may be a contraindication for their use in some cardiovascular studies.

Benzodiazepine tranquilizers used in swine include diazepam and midazolam. Diazepam (0.5–10 mg/kg SC, IM or 0.44–2 mg/kg IV) is usually combined with other agents (Benson and Thurmon, 1979; Bolin and Runnels, 1992; Schranz et al., 1988; Thurmon and Tranquilli, 1986). It has also been given as a continuous IV infusion (1 mg/kg/h) (Riou et al., 1988). The benzodiazepines provide good hypnosis and sedation in swine; however, they are associated with hypothermia with prolonged use (Danneberg et al., 1986). This hypothermia can be profound and life-threatening especially if combined with other anesthetic agents. A specific benzodiazepine reversal agent, flumazenil, has been developed but its use has not been described in swine (Branson and Gross, 2001).

Midazolam (100–500 µg/kg IM or IV) is a water-soluble benzodiazepine which has been described as a sole agent providing deep sedation for 20 minutes with minimal depression of the cardiovascular and respiratory systems (Goodrich et al., 2001; Smith et al., 1991). Higher dosages of midazolam (1 mg/kg IV) have been used in anesthetized swine (Ochs et al., 1987). Continuous IV infusions have been administered at a rate of 0.6–1.5 mg/kg/h (Swindle, 2007). Other benzodiazepines have been described for experimental use in swine and include brotizolam (1–10 mg/kg PO) (Danneberg et al., 1986), lorazepam (0.1 mg/kg IV or intraosseous) (Pender et al., 1991), clonazepam (Becker, 1986), and flurazepam (2 mg/kg IV or PO) (Ochs et al., 1987).

Butyrophenone tranquilizers used in swine include droperidol, fluanisone, and azaperone. Droperidol and fluanisone are not routinely used as sole agents in swine and will be discussed with combination drugs. Azaperone was introduced as an agent to prevent fighting in swine but has been used as a preanesthetic (2–4 mg/kg IM) or it may be used as an immobilizing agent in a higher dosage (5.3–8 mg/kg IM) with minimal depression of cardiovascular function (Gross, 2001; Portier and Slusser,

1985; Riebold and Thurmon, 1986; Swindle, 2007; Thurmon and Tranquilli, 1986).

The alpha-2-adrenergic agonist agents xylazine (2 mg/kg IM) (Benson and Thurmon, 1979; Gross, 2001; Riebold and Thurmon, 1986; Swindle, 1991a, 1991b, 2007; Thurmon and Tranquilli, 1986) and medetomidine (0.2 mg/kg IV) have been described in swine, usually in combination with other agents (Vainio et al., 1992). None of these agents has been described as providing sedation in swine without combination with other agents. Xylazine has only transient analgesic activity in swine and produces hypotension and 1–3° heart block and is not satisfactory as a sole agent (Benson and Thurmon, 1979; Riebold and Thurmon, 1986; Swindle, 1991, 2007; Thurmon and Tranquilli, 1986). Medetomidine can be reversed by atipamezole (Flecknell, 1997). Alpha-2 agonists are not effective sedatives or analgesics when used alone in swine.

Reversal agents have not been routinely used in swine; however, doses are reported for yohimbine (1 mg/kg IV) (Armstead et al., 1988) and atipamezole, 0.24–1 mg/kg, any route (Flecknell, 1996).

Anticholinergics are useful in swine to dry secretions of the oral cavity and respiratory tract and to provide a vagolytic effect during endotracheal intubation or tracheal suctioning. Atropine (0.05 mg/kg IM or 0.02 mg/kg IV) or glycopyrrolate (0.004–0.01 mg/kg IM) may be used to produce these effects (Benson and Thurmon, 1979; Riebold et al., 1995; Swindle and Bobbie, 1983). Anticholinergics are indicated to prevent bradycardia caused by vagal stimulation during intubation, secondary to induction, or preanesthetic agents such as opioids. With experience, the routine use of these agents is not necessary unless the heart rate falls below 60 beats per minute. Sinus tachycardia can result from indiscriminate use.

B. Dissociative Agents

Dissociative anesthetic agents, specifically ketamine, are the most commonly used injectable anesthetic agents in swine. These agents provide rapid and safe immobilization with minimal depression of the cardiovascular system. However, they provide poor muscle relaxation and little visceral analgesia; consequently, they are usually combined with other agents (Benson and Thurmon, 1979; Boschert et al., 1996; Loscher et al., 1990; Riebold et al., 1995; Swindle, 2007; Swindle and Bobbie, 1983). Ketamine has been combined with a wide variety of other agents either as a preanesthetic or to produce a surgical plane of anesthesia for minor procedures.

Ketamine (11–33 mg/kg IM) as a sole agent provides approximately 30 minutes of immobilization characterized by catatonia. This muscle rigidity makes intubation difficult, at best, in swine which are anesthetized with ketamine alone. As a sole agent it is unsatisfactory for performing major surgery even if administered as an IV infusion of 3–10 mg/kg/h because of inadequate analgesia and muscle relaxation (Benson and Thurmon, 1979;

Bolin and Runnels, 1992; Short, 1987; Swindle and Bobbie, 1983; Tranquilli et al., 1982; Worek et al., 1988).

Ketamine has been combined with a wide variety of other agents either as a preanesthetic or to produce a surgical plane of anesthesia for minor procedures.

Ketamine (33 mg/kg IM) combined with acepromazine (1.1 mg/kg IM) provides chemical immobilization with muscle relaxation that lasts approximately 30 minutes and is useful as a preanesthetic but the combination is slightly cardio-depressant (Benson and Thurmon, 1979; Riebold et al., 1995; Swindle and Bobbie, 1983). Ketamine (15 mg/kg IM) combined with diazepam (2 mg/kg IM) or azaperone (2 mg/kg IM) produces a state similar to that in the case of the ketamine–acepromazine combination; however, because of the slow onset of action of the drugs, diazepam and azaperone are usually administered 15–20 minutes prior to the ketamine (Riebold and Thurmon, 1986). Ketamine (33 mg/kg IM) and midazolam (500 µg/kg IM) have been used in our laboratory to provide up to 45 minutes of immobilization with a single injection; however, the combination leads to a profound hypothermia and requires 1–4 hours to recover a righting reflex. Ketamine (10 mg/kg IV) and medetomidine (0.2 mg/kg IV) provide 30 minutes of deep sedation; however, it is accompanied by profound but reversible hemodynamic depression (Vainio et al., 1992).

Ketamine (20 mg/kg IM) combined with xylazine (2 mg/kg IM) has been described as a combination for immobilization and minor surgery. The analgesic effects of the xylazine are transient and last only approximately 5 minutes in swine (Swindle, 2007). However, it is possible to intubate swine using this combination and the cardiodepression associated with xylazine can be overcome with anticholinergics (Cantor et al., 1981; Kyle et al., 1979; Trim and Gilroy, 1985). Ketamine (2 mg/kg), xylazine (2 mg/kg), and oxymorphone (0.075 mg/kg) may be administered IV or the dose may be doubled for IM administration to provide short-term chemical restraint suitable for minor surgery (Breese and Dodman, 1984). Ketamine (20 mg/kg IM) and clonazepam (0.5–1.0 mg/kg IM) provide immobilization similar to that induced by the ketamine–diazepam combination (Becker, 1986). A combination for continuous IV infusion, which provides minimal cardiopulmonary depression in swine, has been developed (Thurmon et al., 1986). Ketamine (1 mg/ml), xylazine (1 mg/ml), and glycerol guaiacolate (5%) mixed in 5% dextrose solution is administered as a 1 ml/kg IV bolus followed by a continuous infusion of 1 ml/kg/h. Meperidine (2.2 mg/kg IM) and azaperone (2.2 mg/kg IM) followed in 20 minutes by ketamine (22 mg/kg IM) and morphine (2.2 mg/kg IM) provides up to 1 hour of immobilization without splenic enlargement (Hoyt et al., 1986).

A tiletamine–zolazepam combination (2–8.8 mg/kg IM) is commercially available and provides 20 minutes of immobilization suitable for minor surgery. However, the combination does produce hypothermia and cardiodepression and would not be recommended for use in cardiopulmonary or renal compromised animals (Bolin and Runnels, 1992; Swindle,

1991, 2007). This agent has been combined with xylazine (2.2 mg/kg IM) to produce a surgical plane of anesthesia; however, the combination can produce profound cardiopulmonary depression and prolonged recovery (Swindle, 1991). The cardiodepressive effects are exacerbated when it is combined with alpha-2-adrenergic agonists and they last longer than the period of anesthesia (Swindle, 2007).

In a comparison of Telazol® (4.4 mg/kg IM), ketamine (2.2 mg/kg IM), Telazol (4.4 mg/kg IM)–ketamine (2.2 mg/kg IM)–xylazine (2.2 mg/kg IM), and Telazol (4.4 mg/kg IM)–xylazine (2.2 mg/kg IM), all four induced chemical restraint (Ko et al., 1993). However, only the combinations with xylazine were suitable for intubation and short-term anesthesia. There was no significant difference in the effects of Telazol–xylazine when ketamine was added. Additional studies were performed using Telazol (4.4 mg/kg IM)–ketamine (2.2 mg/kg IM)–butorphanol (0.22 mg/kg IM) and Telazol (4.4 mg/kg IM)–ketamine (2.2 mg/kg IM)–azaperone (0.88 mg/kg IM) without any substantial improvement in quality of anesthesia (Ko et al., 1997). However, no hemodynamic data were collected during this study and the combinations are not recommended for cardiovascular studies until hemodynamic studies have been conducted to determine their exact effects (Ko et al., 1993, 1997). Improvement in outcomes of complex cardiovascular protocols has been demonstrated by elimination of these agents and combinations for anesthesia (Swindle, 2007).

Most of the IM combinations provide only 20–30 minutes of anesthesia suitable for minor procedures or for induction prior to maintenance with an inhalant anesthetic. Of all of the combinations discussed, only ketamine–xylazine, ketamine–midazolam, ketamine–xylazine–glycerol guaiacolate, and tiletamine–zolazepam–xylazine abolish the swallowing reflex adequately to make endotracheal intubation possible without the use of additional anesthetic agents.

C. Barbiturates

Barbiturates can be used for general anesthesia and the pharmacologic effects in swine are similar to those in other species. The pig is prone to apnea secondary to their administration and the use of dilute solutions (1–2.5%) for IV bolus injections is recommended. The severe cardiopulmonary depression associated with prolonged administration of these agents may be alleviated by the use of continuous IV infusions rather than repeated IV boluses. Dosages are affected by many factors including age and the use of other chemical restraint agents. As in other species, the dosages are guidelines and barbiturates should be administered to effect with careful monitoring of vital signs (Riebold and Thurmon, 1986; Swindle, 1991; Thurmon and Tranquilli, 1986). A continuous infusion of ketamine (9–19 mg/kg/h IV) and pentobarbital (6.5–18 mg/kg/h IV) has been demonstrated to be useful for long-term anesthesia (Goldmann et al., 1999; Hanneman et al., 2004).

The ultrashort-acting thiobarbiturates may be utilized either alone or following preanesthesia with ketamine, ketamine combinations, or other chemical restraint agents in order to induce a surgical plane of anesthesia or abolish the swallowing reflex in order to facilitate endotracheal intubation. Thiopental (6.6–25 mg/kg IV) is commonly used for these procedures (Bolin and Runnels, 1992; Riebold and Thurmon, 1986; Swindle, 1991, 2007; Thurmon and Tranquilli, 1986). Thiopental (3–6 mg/kg/h) can be used as a continuous IV infusion to provide prolonged barbiturate anesthesia (Swindle, 1991, 2007; Swindle et al., 1988; Worek et al., 1988). Because the thiobarbiturates are rapidly eliminated by the kidney, they have a short recovery time.

Pentobarbital (20–40 mg/kg IV) is an intermediate-acting barbiturate that can be used for prolonged general anesthesia. Pentobarbital is more cardiodepressant than the thiobarbiturates and may require prolonged recovery time postoperatively due to its prolonged metabolism by the liver (Bolin and Runnels, 1992; Riebold and Thurmon, 1986; Swindle, 1991, 2007; Swindle et al., 1988; Thurmon and Tranquilli, 1986). Pentobarbital can be administered as a continuous IV infusion (5–15 mg/kg/h), which may be particularly useful for nonsurvival studies (Buckley et al., 1979; Swindle, 2007; Worek et al., 1988).

D. Opioid Infusions and Combinations

Continuous IV infusions of opioids have been used with other anesthetics to enhance analgesia and produce balanced anesthesia, and, in higher doses, to produce anesthesia for experimental cardiac surgery. The main advantages of using high-dose opioid anesthetic techniques are that they produce minimal depression of cardiac function and provide protection against cardiac arrhythmias (Ehler et al., 1985; Lunn et al., 1979; Merin et al., 1982; Schumann et al., 1994; Swindle et al., 1986).

Fentanyl and sufentanil are the most commonly used agents for opioid infusion techniques in swine. The agents may be used alone for induction or following light sedation to facilitate IV access. Fentanyl is given as an IV bolus (50 µg/kg) after initiating a continuous IV infusion of 30–100 µg/kg/h (Ehler et al., 1985; Gelman et al., 1987; Swindle et al., 1986). Sufentanil is more potent and is started as an IV infusion at 15–30 µg/kg/h and then an IV bolus of 7 µg/kg is administered (Schumann et al., 1994; Swindle et al., 1993). Starting the IV infusion prior to the bolus prevents muscle rigidity, which is frequently associated with these drugs. Some animals may require supplemental anesthesia with other agents such as isoflurane and nitrous oxide. For this reason, paralytic agents should not be used until there is assurance that the animal is adequately anesthetized. Opioid infusion techniques produce a profound bradycardia during the IV bolus phase, which can be controlled by anticholinergics. The heart rate stabilizes during the maintenance infusion.

Monitoring heart rate and blood pressure are sensitive indicators of an adequate level of analgesia with these techniques.

Fentanyl 0.005 mg/kg IV combined with thiopental 12.5 mg/kg IV for induction followed by fentanyl 0.0025 mg/kg q20–30 minutes, thiopental 1 mg/kg q30 minutes IM, and midazolam 0.25 mg/kg has also been used. However, this combination would probably provide more stable anesthesia if given as a continuous infusion rather than repeated boluses (Oldhafer et al., 1993).

Fentanyl–droperidol is no longer available commercially as a combination. However, it has been used in a combination (0.4 mg fentanyl/ml and 20 mg droperidol/ml) for IM injection at a dose of 1 ml/13.5 kg or 0.25–0.5 ml/kg IV. The combination produces short-term immobilization suitable for preanesthesia or minor surgery. As in other species it is associated with muscular movement, salivation, and hypersensitivity to sound (Benson and Thurmon, 1979; Thurmon and Tranquilli, 1986). It may be combined with ketamine (11 mg/kg IM) at a dose of 1 ml/13.5 kg IM of the fentanyl–droperidol mixture (Benson and Thurmon, 1979; Cantor et al., 1981; Riebold and Thurmon, 1986). This combination provides 30 minutes of anesthesia suitable for minor surgery.

Naloxone (0.5–2.0 mg/kg IV) can be used to reverse opioids (Benson and Thurmon, 1979; Gross, 2001; Nishijima et al., 1988; Swindle, 2007; Trudeau et al., 1988). Alternatively, opioid mixed agonists–antagonists (nalbuphine, butorphanol, and pentazocine) can be used to reverse opioids while maintaining postoperative analgesia (Flecknell, 1996).

E. Miscellaneous Injectables

A mixture of the pregnanediones, alphaxalone, and alphadolone is commercially available in Europe. It may be administered at a dose of 6–8 mg/kg IM followed by 2–3 mg/kg IV. This combination is short acting, lasting only 4–10 minutes, and its use with barbiturates is contraindicated (Bolin and Runnels, 1992; Flecknell, 1987; Glen et al., 1979).

Another combination available in Europe is etorphine–acepromazine (0.245 mg/10 kg IM). Etorphine can be reversed by diprenorphine (0.3 mg/kg IM) or naloxone 0.01–0.05 mg/kg IV. The use of these combinations does not have any specific advantages over the anesthetic agents available in the United States, and cardiovascular depression and muscle rigidity may be encountered (Bolin and Runnels, 1992; Glen et al., 1979).

Alpha-chloralose has been used in the past for non-survival experimental procedures as a continuous infusion providing minimal cardiac depression and a sparing effect on the baroreceptors. Its use as a sole agent is discouraged, because of its questionable analgesic value, if other methods such as high dose narcotic or propofol infusions can be substituted (Silverman and Muir, 1993). Alpha-chloralose can be administered to swine at a dose of 55–86 mg/kg IV followed by a continuous IV infusion to effect for maintenance (Thurmon and Tranquilli, 1986). For

short-term acute cardiovascular studies, droperidol 2 mg/kg IM followed by flumitrazepam 50 µg/kg IV for induction followed by alpha-chloralose 60 mg/kg IV with a maintenance infusion of 20 mg/kg/h was deemed satisfactory. Hemodynamics were stable for 2–3 hours (Benharkate et al., 1993).

Etomidate (4–8 mg/kg IV) has been used as a sedative in swine with minimal analgesia and muscle relaxation. When combined with azaperone (2 mg/kg IM) sedation and analgesia suitable for minor surgery or preanesthesia can be produced (Holzehuh and Cremonesi, 1991). It has also been used to induce anesthesia at 0.6 mg/kg IV followed by a ketamine infusion of 10 mg/kg/h (Worek et al., 1988).

Propofol is an IV hypnotic agent that has been described for use in swine after induction with azaperone and thiopental (Foster et al., 1992). It provides effective sedation and muscle relaxation for anesthesia with minimal depression of cardiovascular function. Analgesia is only adequate for major surgery if infused at the higher dosages and then it becomes cardiodepressant. Induction of anesthesia by bolus injections of 0.83–1.66 mg/kg IV was followed by incremental IV boluses approximating an infusion rate of 14–20 mg/kg/h. In a similar experiment, propofol was administered as an IV infusion of 12 mg/kg/h to demonstrate its safety in malignant hyperthermia susceptible swine (Raff and Harrison, 1989) and also its effectiveness for a teaching protocol in laparoscopic surgery at the same rate (Ramsey et al., 1993). It is best utilized in infusion combinations with other agents and has been combined successfully as an IV infusion of propofol (2.0–4.4 mg/kg/h), midazolam (0.4–0.7 mg/kg/h), and fentanyl (0.003–0.005 mg/kg/h) (Kaiser et al., 2003, 2006).

Metomidate (4 mg/kg IV) has been given following preanesthesia with azaperone (2 mg/kg IM). The metomidate had to be repeated as bolus injections every 15–30 minutes but could probably be used as a continuous IV infusion (Svendsen and Carter, 1989). It has also been used as a premedication at 5 mg/kg IM with azaperone 6 mg/kg IM followed by IV atropine 0.01 mg/kg, metomidate 2.5 mg/kg, fentanyl 0.01 mg/kg, and droperidol 1 mg/kg. Analgesics were repeated as indicated (Kreimeier et al., 1993). These combinations provided relatively stable cardiovascular function with minimal depression for short-term acute studies. However, others (Thurmon and Tranquilli, 1986) have reported that the metomidate dosage should be increased to 15 mg/kg to enhance the anesthetic state. Even at this dosage, metomidate has questionable anesthetic value when compared to other combinations.

VI. REGIONAL ANALGESIA

Regional analgesia is the reversible loss of sensation to a limited body area without loss of consciousness. Most surgical procedures in a research setting are performed under general anesthesia. However, regional anesthesia may be indicated for brief surgical procedures or when physiologic alterations due

to general anesthesia are to be avoided. Knowledge of porcine anatomy and mastery of the technical skills are required for successfully providing regional anesthesia. To minimize stress and achieve immobilization, regional anesthesia should be performed using sedatives and with the animal physically restrained in a sling. The most commonly used local analgesic is lidocaine with a duration of action of 90–180 minutes. Longer-acting local analgesics, such as bupivacaine, provide 180–300 minutes of analgesia (Short, 1987).

Injection of a local analgesic at the surgical site, or infiltration analgesia, places the agent in direct contact with nerve endings. In research, this technique is best suited for minor, minimally invasive procedures (e.g., auricular venipuncture). Any pathological process involving the injection site, such as infection or decreased vascularization, would be a contraindication for regional analgesia. The most commonly used form of regional analgesia in farm swine is epidural analgesia at the lumbosacral space using morphine (0.1 mg/kg). Descriptions of this technique for farm swine have been published (Scarda, 1996; Short, 1987; St. Jean and Anderson, 1999; Swindle, 1986, 2007). The depth of spinal needle penetration is dependent on the size of the animal. This technique provides analgesia by depositing the analgesic within the epidural space. It will produce analgesia caudal to the umbilicus suitable for laparotomy or cesarian section. Epidural analgesia is contraindicated in animals that are in a state of shock or toxemic because of sympathetic blockade resulting in hypotension (Swindle, 1986). The economic and logistic factors that recommend epidural analgesia for farm swine generally do not apply to research settings. However, the technique may be useful in certain abdominal procedures that preclude the use of general anesthetics.

The primary indication for paravertebral analgesia in research involves control of postoperative pain following thoracotomy. This technique has been utilized successfully to control thoracotomy-related pain prior to the availability of the longer-acting analgesics currently available (Swindle, 2007).

VII. ANALGESIA

Most opioid analgesics have a short half-life in swine limiting their use as postoperative analgesics. Included in this category are fentanyl (0.05 mg/kg IM q2h; 50–100 µg/kg/h IV infusion), sufentanil (5–10 µg/kg IM q2h; 15–30 µg/kg/h IV infusion), meperidine (2–10 IM mg/kg q4h), oxymorphone (0.15 mg/kg IM q4h), and pentazocine (1.5–3 mg/kg IM q4h) (Blum, 1988; Flecknell, 1984, 1987; Swindle, 1991). The short-acting opioids fentanyl and sufentanil can be administered as continuous IV infusions. Morphine has been reported to cause excitement in nonpainful swine similar to the adverse reaction reported for cats. Butorphanol (0.1–0.3 mg/kg IM q4–6 h) is longer acting and has few side effects in swine. Buprenorphine is the postoperative analgesic of choice because in higher doses, it is effective

for 8–12 hours. Low dosages of 0.005–0.01 mg/kg IM have been reported, but this dose is found to be inadequate for major surgical procedures such as organ transplantation and hence the drug is routinely administered in a dose range of 0.01–0.05 mg/kg IM or SC q12h (Hermansen et al., 1986; Rodriguez et al., 2001). The lower dosages may be used IV as a preemptive analgesic. Buprenorphine patches have been developed but their use in swine has not been described. We have not found buprenorphine to be a significant respiratory depressant as determined by postoperative monitoring of blood gases.

Fentanyl patches can be effective; however, their dosage is widely variable depending upon breed, age, location of patch, heat, moisture, and procedure. Overdosage and removal for human drug abuse are possibilities to be considered. A starting dosage is 5 µg/kg/h when the effects are unknown (Harvey-Clark et al., 2000; Swindle, 2007; Wilkinson et al., 2001). The newer generation of nonsteroidal anti-inflammatory drugs (NSAIDs) discussed below are a better choice for most of the procedures.

The newer NSAIDs have been determined to provide significant analgesia for major surgical procedures in swine. Included in this class of analgesics are: carprofen (2 mg/kg SC, q24h; 2–3 mg/kg PO, q12h), flunixin (1–4 mg/kg SC or IM, q12–24h), ketoprofen (1–3 mg/kg IM or SC, PO, q12h), ketorolac (1 mg/kg PO, IM or SC, q12h), and meloxicam (0.4 mg/kg SC, q24h). Short-term administration of these agents does not cause significant interference with platelet levels, gastrointestinal function, or healing. Carprofen, flunixin, and meloxicam are labeled for use in swine in Europe (Swindle, 2007).

For musculoskeletal pain, phenylbutazone may be administered 10–20 mg/kg PO q12h. Aspirin (10–20 mg/kg q4–6h) may also be used. Enteric-coated products are recommended due to the porcine predisposition for gastric ulcers. Oral medication is readily accepted in canned dog food or chocolate syrup (Swindle, 1991; Swindle et al., 1988).

The current preferred analgesics are the newer generation NSAIDs given preemptively prior to making the skin incision. For major procedures this may be combined with infiltration of the incision with a local anesthetic, nerve blocks, and/or epidural injections of morphine. NSAIDs may also be combined with opioids, if required, for severe pain control. The initial dose may be the only one required, depending upon the drug chosen and based upon the clinical assessment of pain. Prolonged use of analgesics may complicate recovery because of poor appetite and depressed cognitive function (Swindle, 2007).

VIII. Intraoperative Monitoring and Support

The focus of intraoperative monitoring is to support the cardiovascular and pulmonary systems and maintain core body temperature. Careful attention to trends in the parameters that are monitored will help prevent anesthetic complications from developing. Interpretation and integration of vital signs and

measured variables should be based on the knowledge of the physiologic effects of the anesthetic agents that have been given and the health status of the animal. Selection of the parameters to be monitored should be tailored to the surgical procedure. For uncomplicated or brief surgeries, monitoring of vital signs and ECG may be adequate. However, for more complex cases such as cardiovascular procedures, monitoring parameters may also include aortic blood pressure, CVP, PAP, and blood gas analysis.

Anesthetic depth is assessed by combining several clinical observations. The normal range for heart rate is between 70 beats/min and 150 beats/min with less than 70 considered to be bradycardia. Generally, young animals tend to have faster heart rates than older animals. Heart rate will vary considerably with the different preanesthetic and anesthetic agents used. Fentanyl and xylazine will produce slower heart rates while atropine and ketamine can cause tachycardia.

Ocular reflexes are not reliable indicators of anesthetic depth for swine. Instead, laxity of jaw tone, absence of a pedal reflex in response to a painful stimulus, and a stable heart rate indicate that a surgical plane of anesthesia has been achieved.

The quality of the peripheral pulse is more difficult to assess in swine than in other species. However, pulse pressure can be monitored using the saphenous, sublingual, and radial arteries. The color of the mucous membranes should be pink, which indicates adequate blood oxygen saturation. It does not assess blood carbon dioxide content.

The best means of assessing the adequacy of lung gas exchange is by performing blood gas analysis on an arterial blood sample or using a pulse oximeter. The medial saphenous and dorsal auricular arteries can be catheterized percutaneously for this purpose.

The most accessible vessels for direct blood pressure monitoring are the external jugular vein, common carotid artery, and the femoral vessels. With experience, all but the common carotid artery can be catheterized percutaneously. However, catheterization can be accomplished most quickly by performing a vascular cut-down and is the recommended method (Swindle, 2007).

ECG monitoring is recommended to detect dysrhythmias. Normal swine have a prolonged Q-T interval that may appear abnormal to those unfamiliar with interpreting porcine ECG's. Because miniature swine are practically hairless, no hair removal is necessary to establish good contact using ECG patches designed for human use. The anesthetist should remember that ECG monitoring only assesses the electrical activity of the heart, which can be completely normal in the face of inadequate circulatory function.

IX. CARDIAC ARRHYTHMIAS

Swine are prone to development of fatal cardiac arrhythmias secondary to manipulation of the heart during cardiac surgery or vagal stimulation following endotracheal intubation,

suctioning of the trachea, or surgical manipulation of the pulmonary bronchus (Swindle et al., 1986). Miniature swine seem to be less susceptible to cardiac arrhythmias than commercial breeds probably due to their greater maturity per kilogram of body weight (Swindle, 2007; Swindle et al., 1988).

Use of bretyllium (3.0–5.0 mg/kg IV) every 30 minutes prior to and during such manipulations will prevent the majority of ventricular arrhythmias. If the injection is administered slowly IV and not repeated more often than every 30 minutes, cardiovascular hemodynamics will be minimally affected (Schumann et al., 1993; Swindle, 1991; Swindle et al., 1986). However, bretyllium is currently off the market and amiodarone can be used as a substitute. Following a loading dose of 10–12 mg/kg IV an infusion of 0.5–3.5 mg/kg/h is given for maintenance. The infusion rate has to be reduced if hypotension occurs.

Lidocaine infusions (2–4 mg/kg IV bolus followed by 50 mcg/kg/min continuous IV infusion) may also be used for prevention of such arrhythmias. If ventricular fibrillation or cardiac asystole occurs, countershock (10 joules internal paddles or 200–400 joules external paddles) is more effective than chemical agents. Pig skin has high electrical resistance, and minimal settings of external defibrillator paddles are ineffective (Schumann et al., 1994).

A technique involving the use of calcium channel blockers and nitroglycerin in combination with bretyllium in order to enable catheterization of coronary vessels without cardiac arrhythmias has been published (Rogers et al., 1988).

X. SUPPORT

Intraoperative fluids are typically administered through an ear vein catheter. A balanced electrolyte solution, such as lactated Ringers, should be given at a maintenance rate of 5–10 ml/kg/h. Administration of warmed IV fluids will help maintain body temperature during prolonged surgeries.

General anesthetic agents, particularly inhalation agents, produce hypothermia, which can be significantly exacerbated by neglecting to take measures in the operating room to reduce heat loss. Core body temperature should be monitored by placement of a probe either rectally or in the thoracic esophagus. Body temperature should be maintained using thermal support such as circulating water blankets.

For prolonged anesthesia in all species, supporting homeostasis becomes of prime importance. The pig is very prone to hypothermia because it is relatively hairless and has a large body surface area. Hypothermia occurs in the pig within the first hour of anesthesia especially if peripheral vasodilators are used. Thermal support is of vital importance for prolonged procedures. Swine are prone to pulmonary edema and pooling of blood in the abdominal viscera during anesthesia and support of homeostasis by administration of IV fluids, and monitoring of blood gases is important. Postoperative apnea can be a problem especially

if agents like pentobarbital are used. Swine should be weaned from respirators and their ability to breathe without assistance should be monitored.

XI. POSTSURGICAL CARE

Frequent monitoring is the hallmark of good postoperative care. During recovery from anesthesia, vital signs and surgical incisions should be monitored and recorded frequently as needed. Greatest attention should be given to the cardiovascular and respiratory systems. Extubation should be performed only after a strong swallowing reflex is apparent. Transport cages designed for dogs are satisfactory for recovering swine up to 50 kg. Pigs weighing more than 50 kg can be recovered to the point of extubation by placing the animal in lateral recumbency atop a sling. Circulating water blankets can be used with either method. With large swine, water blankets can be placed both atop and below the animal.

Administration of analgesics at the end of general anesthesia, prior to the perception of pain, will reduce the complications of hypoventilation, hypercapnia, and hypoxemia associated with major surgery. Use of an opioid agonist-antagonist will provide adequate analgesia but not cause further respiratory depression.

Facilities and equipment should be available to deal with complications encountered during recovery. Suction should be on hand to clear airway passages of excessive secretions. In the event of laryngospasm or airway obstruction, ready access to intubation supplies, including a laryngoscope, is necessary. A means of providing supplemental oxygen and continued fluid administration may also be necessary during recovery from anesthesia.

The pharmacokinetics of some of the newer broad-spectrum antibiotics have not been established in swine. As a rule of thumb, use of the human pediatric dose and dosing schedule should be followed when adapting human medications for swine. The authors have successfully used the following antibiotic regimen for swine for various cardiac and fetal surgical procedures: ceftriaxone 50–100 mg IV, perioperatively followed by oral cephradine (mixed with canned dog food) 25–50 mg every 12 hours.

XII. SPECIAL ANESTHETIC CONSIDERATIONS

A. Malignant Hyperthermia (MH)

MH is a genetic condition in certain breeds of domestic swine, such as the Landrace, Yorkshire, and Pietrain. The condition is transmitted as an autosomal dominant gene (Hal genotype). The ryanodine receptor gene (*ryr-1* locus) is the probable site (Fuji et al., 1991; Geers et al., 1992; Houde et al., 1993; Mickelson et al., 1988). MH has been encountered in the pig as an

anesthetic complication during surgical procedures (Ehler et al., 1985; Swindle et al., 1988). The condition has not been reported in miniature swine.

The pathophysiology of MH involves an inability of the affected animal to control intracellular ionized calcium levels resulting in a rise in intracellular calcium (Endo, 1977; Putney, 1979). The earliest detectable changes in MH appear in the venous effluents from skeletal muscle and reductions in pH and PO₂, and increases in lactate, PCO₂, potassium, and temperature (Gronert, 1980).

Stress and exercise may be key considerations preoperatively. Potent preanesthetic regimes described elsewhere in this chapter are strongly advised. Ketamine, opioids, and benzodiazepines have all been successfully employed (Ehler et al., 1985; Swindle, 1991). Past and present reviews of the literature suggest a common pathway of excessive myoplasmic Ca⁺⁺. Lopez et al. (1988) reported Ca⁺⁺ is primarily due to excessive release of calcium from the sarcoplasmic reticulum.

Kaplan (1991) succinctly describes the metabolic chain of events. Excessive myoplasmic calcium leads to

1. activation of contractile elements;
2. hydrolysis of ATP;
3. heat production;
4. O₂ consumption;
5. CO₂ and lactate production;
6. uncoupling of oxidative phosphorylation; and
7. eventual cell breakdown and release of intracellular contents [creatin kinase (CK), K⁺, Ca⁺⁺, myoglobin, etc.].

B. Recognition of MH

The first cardinal clinical sign of MH is an elevation in end-tidal CO₂ (ETCO₂). A rise of 5–10 mmHg above an established baseline is highly suspect. Concurrent tachycardia and tachypnea and an increase in temperature (not always) should further alert the anesthetist/anesthesiologist. The increased metabolic rate results in an increased PaCO₂ > 45–50 mm, a decreased pH < 7.25, base deficit < -8, central venous desaturation, and hypercarbia which may occur within 5–10 minutes. If unchecked, fulminant MH will progress to rhabdomyolysis with severe hyperkalemia > 6, increased serum CK, myoglobine-mia, myoglobinuria (a cola-colored urine), unstable blood pressure, and then bradycardia with resulting asystole (from hyperkalemia).

It should be noted that an increase in ETCO₂ and tachycardia may also result from excessive heating of the patient (i.e., heating blanket, ambient temperature, or covers) or hypoventilation, or light anesthesia, or other equipment malfunctions.

There is another syndrome that occurs in the postoperative rather than the induction period in swine, which is genetically distinct from MH. However, the signs are very similar and the symptomatic treatment is the same except that dantrolene is

ineffective. This syndrome tends to occur in related pigs but has yet to be genetically defined (Swindle, 2007).

C. Triggering Agents

Kaplan (1991) has listed triggering drugs: succinylcholine, halothane, isoflurane, enflurane, sevoflurane, and desflurane. Indeed all modern volatile inhalation anesthetics tested can trigger MH, although halothane seems to be the most potent. Barbiturates (i.e., pentothal) have the unique property of delaying MH episodes in animals and can be said to be the safest. Other IV drugs (droperidol, diazepam, midazolam, etomidate, ketamine, propofol, and narcotics), muscle relaxants (pancuronium, vecuronium, atracurium, doxacurium, and mivacurium), ester local anesthetics, and N₂O are considered safe. Anticholinesterases, atropine, and glycopyrrolate are safe and can be used for reversal of neuromuscular blockade if needed.

D. Prevention and Management of MH

The successful prevention and avoidance of MH in susceptible swine has been previously described by appropriate breed selection and prophylactic treatment (Ehler et al., 1985; Swindle et al., 1986).

Dantrolene is the drug of choice for the treatment and prevention of MH. It is a lipid-soluble hydantoin derivative that acts distal to the end-plate within the muscle fiber (Gronert et al., 1976). It is most effective when administered while there is adequate muscle perfusion. It is for this reason that the immediate postbypass dose of dantrolene is administered at the maximum perfusion temperature of 34°C, rather than earlier in the postbypass course (see below). Dantrolene attenuates calcium release without affecting uptake, by action upon the connections between the transverse tubules and the terminal cisternae of the sarcoplasmic reticulum (Flewellen and Nelson, 1982; Quintin et al., 1981; Rittenhouse, 1974).

The porcine minimum effective dose of dantrolene for MH prophylaxis has been demonstrated to be in the range of 3.5–5 mg/kg (Flewellen and Nelson, 1982; Gronert, 1980). With this experimental information, we elect to administer a prophylactic dose prebypass and attenuating doses postbypass.

At effective doses, dantrolene is not associated with serious toxicity. Even very high doses do not produce muscle paralysis, although weakness may result (Flewellen and Nelson, 1982; Gronert, 1980). This weakness appears to cause anorexia and decreased activity, which were ameliorated with lower doses of oral dantrolene (3 mg/kg vs. 5 mg/kg). The only adverse effect of the drug reported in the literature has been hepatic dysfunction in man (Schneider and Mitchell, 1976), which has not been seen with oral administration of less than 3 weeks duration. This effect has not been observed in pigs.

TABLE 15-1

DRUGS USED TO MANAGE
MALIGNANT HYPERTHERMIA

Dantrolene
Sterile H ₂ O to reconstitute dantrolene
Sodium bicarbonate
Dextrose 50%
Insulin
Mannitol 25%
Furosemide

Dantrolene, a mild muscle relaxant and antipyretic, is administered 5 mg/kg PO 10–12 hours prior to surgery. It is repeated 2 hours prior to surgery. An alternate administration is 3.5–5.0 mg IV 1 hour preoperatively with repeated hourly dosages (Ehler et al., 1985). Inhalation and triggering agents are avoided.

E. Treatment and Management of the MH Crisis

In addition to the regular supplies and drugs, the drugs listed in Table 15-1 must be immediately available to manage a MH episode. Although relatively expensive, dantrolene is the effective treatment for MH. It decreases the release of Ca⁺⁺ from the sarcoplasmic reticulum and rapidly reverses the MH episode. Administer enough dantrolene to completely normalize all signs of MH. Failure to do so may cause recrudescence (Flewellen and Nelson, 1982; Kaplan, 1991; Littleford et al., 1991; Rosenberg, 1988).

The recommendations for treatment of fulminant MH episode are listed in Table 15-2 as outlined by Kaplan (1991).

Cardiac arrests and dysrhythmias during MH are almost always the result of hyperkalemia compounded by acidosis. The heart muscle itself is not involved in the pathophysiology of MH. Aggressive treatment of the acidosis and hyperkalemia generally relieves the dysrhythmias. CaCl₂ should be considered only as a last resort. Lastly, calcium channel blocking agents should not be used due to the synergistic effect of dantrolene leading to cardiovascular collapse (Kaplan, 1991).

XIII. CARDIOPULMONARY BYPASS

This segment of the chapter is a general overview and guide to performing survival CPB in swine. The following is a brief description of CPB, a stepwise description including equipment, anesthesia, flow rates, hemodynamics and hematologic parameters, adjunct pharmaceutical agents, and surgical connections. We will discuss some of the anesthetic options successfully used (Mohr et al., 1996; Smerup et al., 2004; Swindle, 2007).

CPB is, by definition, an extracorporeal pumping system that temporarily replaces the physiological functions of the cardiopulmonary system. If the swine to receive CPB do not have

TABLE 15-2
TREATMENT OF MALIGNANT HYPERTHERMIA EMERGENCY

1. STOP ALL TRIGGERING AGENTS immediately. Continue with safe agents if surgery cannot be stopped immediately.
2. HYPERVENTILATE with 100% O₂. Use new circuit and soda lime. Change to “clean MH machine”.
3. ADMINISTER DANTROLENE 2.5 mg/kg IV immediately. Continue until all signs normalize (total dose up to 10–20 mg/kg). Maintain IV dantrolene 1 mg/kg qoh.
4. CORRECT METABOLIC ACIDOSIS—HCO₃ 1–2 meq/kg IV stat. Follow ABGs.
5. HYPERKALEMIA—HCO₃; or glucose 1/2 g/kg and regular insulin 0.15 μ/kg.
6. COOLING—Iced saline, cooling blanket, body cavity lavage, extracorporeal circulation.
7. ARRHYTHMIAS—If persistent, procainamide IV 3 mg/kg start. Max. 15 mg/kg.
8. MONITORS—ABG, VBG, (CVP OR PA), UOP, T° (central), end-tidal CO₂, K⁺, Ca⁺⁺, lactate, CK urine myoglobin, PT, PTT, platelets.
9. MAINTAIN UOP >1 ml/kg/h—Mannitol, furosemide, volume.
10. TRANSFER TO ICU when stable.
11. OBSERVE IN ICU—Stable 24–28 hours. Monitor for recrudescence and late complications.
12. CONVERT TO ORAL DANTROLENE when extubated and stable. 1 mg/kg PO q6 h × 24–28 h.
13. Malignant Hyperthermia Association of the United States 24-hour hotline: 209-634-4917.

Note: ABG = arterial blood gases; VBG = venous blood gases; CK = creatine kinase; CVP = central venous pressure; PA = pulmonary artery; UOP = urine output; PT = prothrombin time; PTT = partial thromboplastin time. Modified from “Suggested Therapy for Malignant Hyperthermia Emergency,” Malignant Hyperthermia Association of the United States (MHAUS).

a propensity for MH or cardiovascular compromise the choice of anesthetic agent does not significantly affect the outcome. There appears to be no evidence that would justify one IV or inhalational agent over the other in healthy normal animals. Ultimately the choice may be dictated by the individual protocol. Conversely, if MH is a deciding factor, there is a drastic difference in selecting “nontriggering” IV anesthetic agents and muscle relaxants. Many of the techniques used in the surgical laboratory have had their initiation from techniques described in various texts, which were then modified. If an inhalation agent is chosen, it can be delivered during CPB through the oxygen supply to the oxygenator.

CPB requires a team approach with effective communications. The perfusionist manages composition of priming solutions, perfusion flows, supplemental fluids, and blood. The anesthetist/anesthesiologist manages drugs, i.e., anesthetics, muscle relaxants, and vasoactive agents. The surgeon and perfusionist control cardioplegia and usually temperature regulation of the heart.

A. Fundamentals and Description of CPB

The system includes a pump (either roller or pulsatile), an oxygenator to imitate lung function (either bubble or membrane), PVC tubing, canulas, and filters. For a more detailed description of by-pass circuitry and the variations that are used, the reader is referred to several texts (Bain, 1988; Gravlee, 1993a, 1993b; Reed and Stafford, 1989).

Blood is withdrawn before it reaches the heart, is oxygenated with CO₂ removed, and is then filtered and returned to the systemic arterial tree distal to the aortic valve. The step-by-step surgical procedure has been previously described (Ehler et al.,

1985). Venous blood is usually withdrawn through a single right atrial cannula for most of the CPB procedures (10–25 kg pigs). An alternate double cannula system placed retrograde into the superior and inferior vena cavae has been used in swine heavier than 40–50 kg. The double cannula system has the advantage of placing less tension on the friable right atrium.

Venous drainage is usually gravity-driven into the venous reservoir. A Sarnes 7000 roller pump or Biomedicus pump Model 520 or 540 drives the blood through an arterial filter back into the aorta.

Membrane oxygenators are now used for all survival procedures. Oxygenators are intrinsically not biocompatible. The blood gas interface represents a nonphysiologic state. CPB procedures <2 hours duration have shown no clinically significant difference between membrane or bubble oxygenators. Membrane oxygenators are preferred when longer perfusions (>2 hours) are to be performed. Both microemboli formation and blood trauma are reduced with membrane oxygenators.

B. Choice of Priming Solutions

For porcine CPB, we use fresh porcine blood from donors under general opioid or barbiturate anesthesia. We generally collect 2–3 units of blood to prime the bypass pump depending upon the weight of the animal to be bypassed. Additional fresh whole blood may be needed postCPB. A neuroendocrine stress response may be initiated in the recipient if the last unit of blood from the donor is used. This is due to the stress of terminal hemorrhage in the donor (Swindle, 2007). Crystalloid solutions either alone or combined with blood have also been used but care is taken to keep the hematocrit >25. There is no consensus as to what constitutes an ideal prime.

C. Myocardial Protection

Myocardial protection during CPB is yet another topic of controversy and is beyond the scope of this paper. The single most decisive factor is the effective application of myocardial preservation techniques during CPB by the surgeon and perfusionist. "The three components of myocardial protection by cardioplegia are the choice of an effective solution, the maintenance of electromechanical inactivity and the use of profound topical hypothermia. Each need consideration if maximal protection is to be achieved" (Brambridge, 1988).

There are three basic methods that are used in combination as indicated by the procedure.

1. Chemical cardioplegia, i.e., Buckberg's solution: 5% dextrose in 0.2% NaCl 550 ml, KCl 20 meq, THAM 200 ml, CPD 50 ml. One part Buckberg:4 parts oxygenated blood. An alternative is cold Plegisol® (Abbott Laboratory, North Chicago, IL) slurry with 10 meq bicarbonate/L.
2. Electrical fibrillation, i.e., 1–6 volts 60 cycle to cause continual ventricular fibrillation, applied through small electrodes directly to the heart.
3. Hypothermic cardioplegia: spontaneous cardiac arrest occurs when the myocardial temperature falls below 20°C. Saline slush is applied directly to the heart as it lies in the bowl-like tacked-up pericardium. During this period of inactivity and myocardial temperature, metabolic rate and O₂ consumption are markedly reduced (Reed and Stafford, 1989).

D. Anticoagulation

Adequate anticoagulation cannot be overemphasized prior to the onset of CPB. Systemic heparinization is initiated with 300 units/kg IV. The adequacy of heparinization must be checked at this point by measuring the activated clotting time (ACT). We routinely maintain an ACT of 350 seconds (Gravlee, 1991b).

Protamine sulphate is used as a reversal agent at the completion of CPB if needed. A 1.3:1 protamine to heparin reversal ratio is used to neutralize heparin administered during extracorporeal circulation. As a general rule 1 mg protamine will neutralize approximately 100 units of heparin, 90 units of sodium heparin bovine lung, 100 units of calcium heparin porcine intestinal mucosa, and 115 units of sodium heparin porcine intestinal mucosa. Protamine should not be used if the ACT falls <180 seconds and problems with bleeding have not been encountered, and should be administered slowly to avoid hypotension.

E. Arterial Pump Flow Rates (APFR)

Beginning arterial input from the pump should be 2.4 L/m²/min (Moffitt et al., 1962). Higher flow rates do not

improve tissue perfusion and oxygenation and are associated with more mechanical blood damage and a greater risk of embolism from microbubble formation (Bain, 1988). Moderate hypothermia allows for lower APFR, i.e., core temperature of 28°C results in 50% decrease in O₂ requirements. An APFR of 60–80 ml/kg/min is satisfactory in chilled larger swine (>25 kg) at 25°C. Small swine (<10 kg) have an increased metabolic requirement; hence, a higher perfusion rate of 80–100 ml/kg/min is required to maintain adequate tissue oxygenation. Flow rates are reduced as hypothermia progresses.

F. Measurement and Monitoring During CPB

Total management of CPB and the subsequent "weaning off the pump" and termination of CPB require the continuous monitoring and measurements of all physiological parameters. The primary purpose is to assure adequate O₂ and CO₂ exchange and tissue perfusion. Although the respirator is turned off during CPB, a slight positive pressure or periodic sighs are advantageous to minimize pulmonary atelectasis postoperatively.

We monitor the following parameters continuously:

ECG/HR	Differs according to size and breed
Mean arterial pressure	50 mmHg ± 5
Central venous pressure	0–5 mmHg during CPB; 8–12 mmHg pre/postCPB
Arterial pump pressure	<200 mmHg (depending upon circuit and cannula sizes)
Systemic venous O ₂ (SvO ₂) saturation	70 ± 5%
Systemic vascular resistance (SVR)	800–1,400 dyne s cm ⁻⁵
Core temperature	Esophageal, rectal probes, and/or with tympanic membrane probes (most sensitive)
Blood temperature	In both venous and arterial lines (Note: arterial <38°C)
Coolant temperature	40°C (in heat exchanger) (Note: the temperature gradient in C° between the coolant in the heat exchanger and venous return should be 10–12°C)

We monitor the following as needed:

PaO ₂ , PaCO ₂	PaO ₂ between 100 and 200 mmHg; PaCO ₂ 40 mmHg ± 4
Arterial pH	7.38–7.42
Base excess	0 to –5
Hematocrit	>18% (prefer >25%)
K ⁺	4.5–5.5 mmol/L
ACT	>300 seconds

TABLE 15-3
SUGGESTED CPB HEMATOCRIT RANGE AT DIFFERENT
TEMPERATURES IN HUMANS

Temperature range (°C)	Hematocrit range (%)
30–37	25–30
23–30	20–25
15–22	15–20

Source: Gravlee (1993).

LA and PWP are monitored as needed. A general rule is to match the pressure pre- and post CPB.

Assessment of O₂ delivery during CPB, hypothermia, hemodilution, and deep anesthesia are difficult at best. During normothermic perfusion, flows exceeding 2.2 L/m²/min are usually sufficient, but might become inadequate in the presence of rewarming, “light” anesthesia, or especially low hematocrit levels (<18%). Hypothermia decreases O₂ consumption approximately 7%/°C, and pump flows can be reduced proportionately (Gravlee, 1991a). Thus, reduced O₂ consumption allows one to safely reduce perfusion flow rates, hematocrit, or both without compromising O₂ delivery during hypothermia.

As a general rule of thumb, the percent hematocrit is approximately equal to temperature in degree celsius during hypothermia. Gravlee suggests CPB hematocrit ranges at varying temperatures in man (see Table 15-3). He alerts the reader that these recommendations have not been subjected to rigorous scientific validation (Gravlee, 1993).

When CPB is initiated, the arterial BP falls and then slowly rises to normal or above normal levels during CPB. What the “ideal pressure” may be is controversial. Mean pressure <30 mmHg is below the critical closing pressure of some vascular beds, and significant underperfusion of tissue may result (Table 15-4) (Bain, 1988).

G. Central Venous Pressure (CVP)

Normal CVP in normothermic-anesthetized swine on intermittent positive pressure ventilation is approximately 4–10 mmHg. During CPB, venous pressure drops to zero. When CPB is completed and normal circulation restored, the CVP is useful in determining volume replacement by adding 25–50-ml increments from the pump. CVP monitoring is beneficial through the early postoperative period to judge volume adjustments. Bain (1988) reported that the baseline CVP in a well-sedated patient on intermittent positive pressure ventilation is about 4–5 mmHg higher postoperatively. We have observed similar trends. CVP in these ranges are acceptable. It should be noted that a progressive sustained rise in CVP postoperatively is a hallmark for cardiac failure or peripheral vasoconstriction (°SVR) if colloids were not infused.

TABLE 15-4
CARDIAC INDEX (CI) AND HYPOTHERMIA TEMPERATURES
FOR CARDIOPULMONARY BYPASS

Temperature (°C)	CI
37	2.2–2.4
34–37	2.0–2.2
30–34	1.8–2.0
28–30	1.6–1.8
24–28	1.6–1.8
18–24	1.5–1.6

Note: CI × body surface area (BSA) = Perfusion flow rate.

H. Left Atrial and Pulmonary Wedge Pressure (LA & PWP) Measurement

Left atrial pressure can be determined using a balloon-tipped Swan-Ganz catheter. We introduce the catheter into the femoral vein using the Seldinger technique (Gaymes et al., 1995). We introduce an 18-gauge angiocath into the vein, withdraw the stylet, and then introduce a guide wire through the angiocath. With the guide wire in place the angiocath is withdrawn over the guide wire. An appropriate-size (8 French) catheter introducer is then inserted into the femoral vein over the guide wire and the guide wire is withdrawn. The introducer is sutured into place with 2-0 Prolene. The Swan-Ganz catheter is then advanced up the inferior vena cava through the right atrium, into the right ventricle, and out into the PA measuring PAP, in the “wedged” position (balloon tip expanded); the pulmonary capillary wedge pressure (PCWP) is measured and is an index of left atrial pressure. The Swan-Ganz catheter also can measure cardiac output by thermodilution measurement techniques. Normal left atrial pressure is 5–15 mmHg. Left ventricular function can be monitored. PWP is a useful index of myocardial function when “weaning off” or coming off CPB.

I. Termination of CPB or “Weaning off the Pump”

The core temperature should be stabilized at preCPB levels before warming is initiated. Generally termination of CPB is uneventful. When CPB is terminated the heart will either function effectively or not function at all. Cardiac performance is the limiting factor in most instances. Hence, it may be necessary to reinstitute CPB. Adequate cardiac output will not result until blood volume is restored in the pig. Usually we slowly occlude the venous return line with a tubing clamp until the surgeon decides the right atrium and PA are subjectively “back to normal”. Arterial perfusion is stopped. Further volume expansion is administered in 25–50-ml increments to maintain a systolic pressure of 100 mmHg ± 10. Conversely, overexpansion may put the heart into cardiac failure. Gradually titrating back toward pre-CPB pressures has worked best for our laboratory.

Impatience can result in perilous premature termination of CPB. Subsequently, hearts that may have performed well with a little more recovery time may need to be treated with high doses of inotropes. This in turn can potentially delay myocardial recovery (Gravlee, 1991a). If cardiac output is inadequate CPB should be resumed and the heart allowed a more reasonable recovery period. Continue at reduced CPB flows within normal tissue oxygenation limits as previously described (SvO_2 $70 \pm 5\%$). When the myocardium has rested for 5–10 minutes the “weaning process” is repeated. Once successful separation from CPB has been completed, the recovery phase begins.

During the recovery period, electrocardiographic, temperature, and arterial and venous pressure monitoring is continued. Arterial blood gas tensions, hematocrit, and serum electrolytes are obtained hourly or more frequently if clinical conditions dictate. Whole blood is administered to maintain the CVP between 8 mmHg and 12 mmHg. Once monitoring parameters indicate a return to homeostasis, the pigs are withdrawn from mechanical ventilation usually between 3 hours and 5 hours after completion of the surgical procedure, without the use of anticholinesterase agents to reverse neuromuscular blockade. Throughout this initial postoperative period a slow rewarming process via warming blanket and manipulation of environmental temperature is undertaken. Oxygen must be provided as required. Negative pressure is re-established in the thoracic cavity through the use of a surgically implanted chest tube. Suction is applied either continuously or intermittently using a Heimlich valve, water trap or similar device. Output of air or blood is recorded and replaced as necessary. Excessive bleeding through the chest tubes has not been a problem.

In the absence of complications, the pig is removed from the ICU cage the morning following surgery when ambulation and oral alimentation are begun. The chest tubes are removed 24 hours after surgery.

This description of CPB has had routine success in our laboratories; however, variations between laboratories may dictate changes in the described procedures. For a more indepth understanding of the complexities and physiological trespass of CPB the reader is referred to three excellent texts (Gravlee, 1991a; Reed and Stafford, 1989; Taylor, 1988).

J. Anesthetic Management

Anesthesia for CPB, for the most part, encompasses the traditional goals of anesthesia: adequate analgesia, hypnosis, and muscle relaxation. These can be met with minor changes in anesthetic techniques used for general surgery described elsewhere in this chapter. But the anesthetist must take into consideration the “physiologic trespass” one is inducing with CPB. Numerous investigators have addressed plasma levels of anesthetics pre-, during, and postCPB (Buylaert et al., 1989; Holley et al., 1982; Okutani et al., 1988; Reves et al., 1989). Plasma levels decrease proportionately to volume of the priming solution used. Gravlee

(1991b) reports “while it might superficially appear that this would immediately lighten the anesthetic plane, the occurrence is potentially counterbalanced by an increase in the plasma ratio of free drug to protein-bound drug (enhancing drug available to cross the blood-brain barrier) and acute reduction in perfusion to some peripheral vascular beds (discouraging redistribution into peripheral compartments)”. In addition, drugs with relatively large apparent volumes of distribution (such as fentanyl) have redistributed before CPB, leaving a rather substantial drug “sink” in both central and peripheral compartments. Gravlee reports plasma levels of fentanyl rise after separating from CPB, probably because pulmonary reperfusion re-establishes plasma compartment access for drug that has been sequestered in the lungs. This appears to hold true for other opioids and probably propofol. The synthetic opioids bind to the membrane circuit and tubing, hence reducing the anesthetic agent available.

It is important to recognize that anesthetic regime will be quite different with hypothermic CPB versus normothermic CPB. Anesthetics, muscle relaxants, and vasoactive drug requirements are directly proportional to the patient’s core temperature.

Upon reviewing the veterinary and human anesthesia literature, one can be overwhelmed with the myriad of anesthetic protocols available. The bottom line is two-fold: (1) the anesthetic regime must be consistent with the protocol’s goal; and (2) the anesthetist/anesthesiologist must completely understand the agents selected and feel comfortable with their use.

Numerous studies have investigated the effect of anesthetics on the outcome of CPB. The common conclusion was that the choice of agents used—IV or inhalational—had no effect on the outcome of CPB (Slogoff and Keats, 1989; Tuman et al., 1989). Taking into account that swine and humans appear to react pharmacokinetically similarly, one can interpolate if MH is *not* a factor.

Techniques that have evolved at our institution for swine with and without the MH factor are described below.

K. Anesthesia for Normal (MH-Free) Pigs for CPB

Any of the anesthetic regimes described previously can be used. The inhalation agents are excellent selections, alone or in combination with opioids, benzodiazepines, or propofol. In combination with a broad selection of muscle relaxants, swine anesthesia takes on all the benefits of “balanced anesthesia” described elsewhere in this chapter.

L. CPB Anesthesia for MH Positive Pigs

Preoperatively the pigs are treated with a single oral dose of dantrolene, 5 mg/kg, on the afternoon before surgery (Ehler

et al., 1985; Gronert et al., 1976). This dose of dantrolene is repeated 2 hours before surgery.

Ketamine hydrochloride is administered at a dose of 30 mg/kg intramuscularly, after which a steel IV needle is inserted into an ear vein. Anesthetic induction is performed using IV sodium thiopental, 10 mg/kg. The animals are intubated orotracheally with a 5.6 mm cuffed endotracheal tube. Early maintenance of anesthesia consists of 100% oxygen, utilizing an oxygen-flushed anesthesia machine. (Note: Swine are subject to apnea with barbiturate induction. Ventilate immediately at 18–20 ml/kg at 20–25 cycles/min.)

With secure venous access in place, a “high-dose” opioid technique is initiated with fentanyl, 50–100 μ g/kg/h intravenously (Ehler et al., 1985; Lunn et al., 1979; Quintin et al., 1981; Swindle, 1991; Swindle et al., 1986). Pancuronium bromide, 0.15 mg/kg, and dantrolene, 4 mg/kg, are also administered intravenously at this time (Ehler et al., 1985). Pancuronium bromide has been reported to have some protective effect over MH in MH-susceptible swine (Hall et al., 1976; Short et al., 1976). Sufentanil citrate, 5.0–7.0 μ g/kg IV followed by 15–30 μ g/kg/h and vecuronium, 0.1 mg/kg IV loading dose followed by 30 mg/kg/h is an alternative regime (Schumann et al., 1994).

We selected the high-dose narcotic anesthetic technique in an effort to avoid a stress response in the perioperative period. It is known that the use of fentanyl in a dose of 50 μ g/kg can prevent the rise in cortisol, growth hormone, and glucose commonly associated with the stress response (Hall et al., 1978).

During normothermic procedures, pigs have a propensity for fatal cardiac arrhythmias from cardiac manipulations. Amiodarone, dosed as previously described, is an effective preventative agent during thoracic surgery. It may be repeated by slow IV infusion every 30 minutes without affecting hemodynamics (Swindle, 1985; Swindle et al., 1986, 1988).

Depending upon the procedure being performed, deep hypothermia and circulatory arrest may be used. Upon completion of the procedure, rewarming is begun. When the pig has

been rewarmed to 34°C, ventilation with 100% oxygen is reinstated, and the pig is slowly withdrawn from CPB. At this time additional pancuronium bromide, 0.15 mg/kg, and dantrolene, 1.0 mg/kg, are administered by slow IV infusion. We have not found it necessary to use temporary pacing in any of our experimental animals. Oral dantrolene, 3 mg/kg q8h, is continued for three doses. If deep hypothermia is not used, cold cardioplegia, as previously described in this chapter, is used for myocardial protection.

M. Recent Developments in CPB in Swine

Problems related to weaning swine from CPB from such issues as neurological failure and postperfusion pulmonary hypertension have been a predominant source of failure (Cameron et al., 1992; Swindle, 2007). Since the publication of the first edition of this textbook, several laboratories have developed techniques that have improved the outcome of these procedures (Belanger et al., 2003; Li et al., 2004; Pokela et al., 2002; Smerup et al., 2004; Swindle, 2007). Many of the complications associated with pulmonary failure can be prevented by administration of methylprednisolone 500 mg IV (Smerup et al., 2004) or indomethacin 50 mg suppositories (Swindle, 2007) prior to the induction of CPB. Sildenafil 12.5 mg PO is being investigated in humans to treat pulmonary hypertension postCPB, but its use has not been reported in swine.

XIV. SUMMARY AND ADDITIONAL REFERENCE MATERIAL

Tables of commonly used drugs are listed in Appendix Tables 15-A.1–15-A.7. These charts do not include indications and contraindications of the agents administered. They also exclude the use of continuous IV infusions of parenteral agents. Please refer to the text for those details.

Appendix Tables

TABLE 15-A.1
DISSOCIATIVE ANESTHETICS AND COMBINATIONS

Drug name (generic)	Dose (mg/kg)	Route of administration	Approximate duration	References
Ketamine*	11–33.0	IM, SC, IV	30 minutes	Benson and Thurmon, 1979 Bolin and Runnels, 1992 Short, 1987 Swindle and Bobbie, 1983 Boschert et al., 1996 Flecknell, 1996 Tranquilli et al., 1982 Woreck et al., 1988 Riebold et al., 1995
Ketamine–acepromazine*	33.0 1.1	IM, SC	30 minutes	Boschert et al., 1996 Flecknell, 1996 Swindle and Bobbie, 1983 Benson and Thurmon, 1979 Riebold and Thurmon, 1986
Ketamine–diazepam*	5.0 2.0	IM, SC	20 minutes	Boschert et al., 1996 Flecknell, 1996
Ketamine–medetomidine*	10.0 0.2	IV, IM, SC	30 minutes	Vainio et al., 1992 Flecknell, 1996, 1997
Ketamine–azaperone	15.0 2.0	IM, SC	20 minutes	Riebold and Thurmon, 1986 Boschert et al., 1996 Flecknell, 1996
Ketamine–midazolam	33.0 500 µg	IM, SC	45 minutes	Swindle, 2007
Ketamine–xylazine	20.0 2.0	IM, SC	20 minutes	Boschert et al., 1996 Kyle et al., 1979 Cantor et al., 1981 Trim and Gilroy, 1985
Ketamine–xylazine–oxymorphone	2.0 2.0 0.075	IV, IM, SC (2× dose)	20 minutes	Breese and Dodman, 1984
Ketamine–climazolam	20.0 0.5–1.0	IM, SC	20 minutes	Becker, 1986
Ketamine–meperidine–azaperone–morphine	22.0 2.2 2.2 2.2	IM, SC	1 h	Hoyt et al., 1986
Tiletamine–zolazepam (Telazol)	2.0–8.8	IM, SC	20 minutes	Bolin and Runnels, 1992 Swindle, 1991
Telazol–xylazine	2.0–8.8 2.2–4.4	IM, SC	20–45 minutes	Ko et al., 1993, 1997 Swindle, 1991
Telazol–ketamine	4.4 2.2	IM, SC	20–30 minutes	Ko et al., 1993
Ketamine–Telazol–xylazine	2.2 4.4 2.2	IM, SC	20–30 minutes	Ko et al., 1993
Telazol–ketamine–butorphanol	4.4 2.2 0.22	IM, SC	45 minutes	Ko et al., 1997
Telazol–xylazine–azaperone	4.4 2.2 0.88	IM, SC	30 minutes	Ko et al., 1997

TABLE 15-A.2
TRANQUILIZERS, HYPNOTICS, AND SEDATIVES

Drug name (generic)	Dose (mg/kg)	Route of administration	Approximate duration	References
Acepromazine*	0.11–1.1	IM, IV, SC	6–8 hours	Riebold and Thurmon, 1986 Benson and Thurmon, 1979
Promazine	0.44–2.0	IM, IV, SC	6–8 hours	Swindle and Bobbie, 1983 Bolin and Runnels, 1992 Riebold and Thurmon, 1986 Benson and Thurmon, 1979
Chlorpromazine	0.5–4.0	IM, IV, SC	6–8 hours	Bolin and Runnels, 1992 Riebold and Thurmon, 1986 Benson and Thurmon, 1979
Diazepam*	0.5–10	IM, SC	2–4 hours	Swindle and Bobbie, 1983 Benson and Thurmon, 1979
Diazepam	0.44–2.0	IV	2 hours	Thurmon and Tranquilli, 1986 Bolin and Runnels, 1992 Schranz et al., 1988
Midazolam*	0.1–0.5	IM, SC, IV	20 minutes	Oldhafer et al., 1993 Goodrich et al., 2001 Smith et al., 1991
Brotizolam	1–10	PO	2.4 hours	Smith et al., 1991 Danneberg et al., 1986
Lorazepam	0.1	IV	12–24 hours	Pender et al., 1991
Climazolam	2.0	IV	20 minutes	Becker, 1986 Portier and Slusser, 1985 Riebold and Thurmon, 1986 Benson and Thurmon, 1979
Xylazine	0.2	IM, SC	5 minutes	Thurmon and Tranquilli, 1986 Swindle, 1991a
Etomidate	4.0–8.0	IV	15 minutes	Holzchuh and Cremonesi, 1991
Metomidate	4.0	IV	15 minutes	Svendsen and Carter, 1989
Fentanyl–droperidol	1 ml/13.5 kg	IM, SC		Benson and Thurmon, 1979
	0.25–0.5 ml/kg	IV	20 minutes	Thurmon and Tranquilli, 1986
Ketamine	11.0			Benson and Thurmon, 1979
Fentanyl–droperidol	1 ml/13.5 kg	IM, SC	30 minutes	Cantor et al., 1981 Riebold and Thurmond, 1986
Alphaxolone/Alphadolone	6.0–8.0	IM, SC		Glen et al., 1979
	2.0–3.0	IV	4–10 minutes	Bolin and Runnels, 1992 Flecknell, 1987
Etorphine–Acepromazine	0.025	IM, SC	20 minutes	Glen et al., 1979 Bolin and Runnels, 1992 Flecknell, 1987
Etomidate–azaperone	4.0–8.0	IV		
	2.0	IM, SC	15–45 minutes	Holzchuh and Cremonesi, 1991
Propofol	0.83–1.66	IV	10–15 minutes	Foster et al., 1992 Raff and Harrison, 1989 Ramsey et al., 1993
Metomidate–azaperone	4.0–15.0	IV		Thurmon and Tranquilli, 1986
	2.0	IM, SC	15–30 minutes	Svendsen and Carter, 1989

TABLE 15-A.3
MISCELLANEOUS ANESTHETIC AND PERIOPERATIVE DRUGS

Drug name (generic)	Dose (mg/kg)	Route of administration	Approximate duration	References
Atropine*	0.05	IM, SC	30 minutes	Riebold et al., 1995
	0.02	IV	30 minutes	Swindle and Bobbie, 1983
Glycopyrrolate	0.004–0.01	IM, SC	30 minutes	Benson and Thurmon, 1979
			Riebold et al., 1995	Swindle and Bobbie, 1983
Thiopental*	6.6–25.0	IV	10–20 minutes	Bolin and Runnels, 1992
				Riebold and Thurmon, 1986
				Thurmon and Tranquilli, 1986
				Swindle, 1991
Pentobarbital	20–40	IV	20–30 minutes	Bolin and Runnels, 1992
				Riebold and Thurmon, 1986
				Thurmon and Tranquilli, 1986
				Swindle, 1991
Naloxone	0.5–2.0	IV		Swindle et al., 1988
				Benson and Thurmon, 1979
				Nishijima et al., 1988
				Trudeau et al., 1988
Yohimbine	1.0	IV		Armstead et al., 1988
Bretyllium	3.0–5.0	IV	30 minutes	Swindle et al., 1986
Amiodarone*	10–12	IV	30 minutes	Swindle, 2007

TABLE 15-A.4
NSAID AND OPIOID ANALGESICS

Drug name (generic)	Dose (mg/kg)	Route of administration	Approximate duration	References
Fentanyl	0.05	IM, SC	2 hours	Flecknell, 1984
				Flecknell, 1987
				Swindle, 1991
				Blum, 1988
Sufentanil	0.005–0.01	IM, SC	2 hours	Flecknell, 1984
				Flecknell, 1987
				Swindle, 1991
				Blum, 1988
Meperidine	2.0–10.0	IM, SC	4 hours	Flecknell, 1984
				Flecknell, 1987
				Swindle, 1991
				Blum, 1988
Oxymorphone	0.15	IM, SC	4 hours	Flecknell, 1984, 1987
				Swindle, 1991
				Blum, 1988
Pentazocine	1.5–3.0	IM, SC	4 hours	Flecknell, 1984, 1987
				Swindle, 1991
				Blum, 1988
Butorphanol	0.1–0.3	IM, SC	4–6 hours	Flecknell, 1984
				Swindle, 1991
				Flecknell, 1987
Buprenorphine	0.05–0.1	IM, SC	8–12 hours	Hermansen et al., 1986
				Rodriguez et al., 2001
				Swindle, 1991
Phenylbutazone	10–20	PO	12 hours	Swindle, 1991
				Swindle et al., 1988

(Continued)

TABLE 15-A.4

CONTINUED

Drug name (generic)	Dose (mg/kg)	Route of administration	Approximate duration	References
Aspirin	10	PO	4–6 hours	Swindle, 1991 Swindle et al., 1988
Flunixin	1–4	IM, SC	12–24 hours	Swindle, 2007
Ketorolac	1	PO, IM, SC, IV	12 hours	Swindle, 2007
Ketoprofen	1–3	IM, SC, PO	12 hours	Swindle, 2007
Meloxicam	0.4	SC	24 hours	Swindle, 2007
Carprophen	2–3	IM, SC, PO	24 hours	Swindle, 2007

Note: This chart does not include indications and contraindications of the agents administered. It also excludes the use of continuous IV infusions of parenteral agents. Please refer to the text for details.

TABLE 15-A.5

PROTOCOL FOR ROUTINE SURGERY WITHOUT PHYSIOLOGIC MEASUREMENTS

Preanesthesia	Induction	Maintenance
Atropine 0.05 mg/kg SC		Isoflurane 0.5–2.0%
Ketamine 33.0 mg/kg SC	Isoflurane via face mask 4–5%	Deliver in oxygen:nitrous oxide
Acepromazine 1.1 mg/kg SC		

TABLE 15-A.6

PROTOCOL FOR NONSURVIVAL TEACHING LABORATORIES

Preanesthesia	Induction	Maintenance
Atropine 0.5 mg/kg SC	Pentobarbital 20–40 mg/kg IV	Pentobarbital 5–15 mg/kg/h IV
Ketamine 33.0 mg/kg SC	or	or
Acepromazine 1.1 mg/kg SC	Thiopental 6.6–25.0 mg/kg IV	Thiopental 3.0–6.0 mg/kg/h IV

TABLE 15-A.7

OPIOID INFUSION PROTOCOL FOR CARDIOPULMONARY BYPASS WITH CARDIAC COMPROMISE

Preanesthesia	Induction	Maintenance
Fentanyl 30–50 µg/kg IV or sufentanil 7–15 µg/kg IV	Fentanyl 50–100 µg/kg/h IV or sufentanil 1–30 µg/kg/h IV	Supplement as required with 0.25–0.5% isoflurane or with 1.0–2.0% sevoflurane

The most highly recommended agents and combinations are marked with an asterisk “*”.

A. Websites

1. Contains swine literature database from Animal Welfare Information Centerb
<http://www.nal.usda.gov/awic/pubs/swine/swine.htm>
2. Contains reviews of models and Sinclair, Hanford and Yucatan information
<http://www.sinclairresearch.com/>
3. Tutorial on swine procedures in research: Laboratory Animal Training Association
<http://www.latanet.com/online/onlinetr.htm>
4. Biology and diseases of swine
http://www.ivos.org/advances/Reuter/swindle/chapter_frm.asp?LA=1
5. Basic information on swine
<http://www.aphis.usda.gov/vs/ceah/cahm/Swine/swine.htm>
<http://www.nal.usda.gov/awic/pubs/swinehousing/swinehousing2.htm>
6. Göttingen minipig background information
<http://minipigs.dk>
7. CD Rom training series on Husbandry, Handling, Injection Techniques, Anesthesia, Analgesia, and Perioperative Care
<http://www.latanet.com/desktop/drs.html>
<http://www.latanet.com>
8. National Swine Research Resource Center
<http://www.nsrcc.missouri.edu/>

REFERENCES

- Armbruster, K., Noldge-Schomburg, G.F., Dressler, I.M., Fittkau, A.J., Haberstroh, J., and Geiger, K. (1997). The effects of desflurane on splanchnic hemodynamics and oxygenation in the anesthetized pig. *Anesth. Analg.* **84**(2), 271–277.
- Armstead, W.M., Leffler, C.W., Busija, D.W., Beasley, D.G., and Mirro, R. (1988). Adrenergic and prostanoid mechanisms in control of cerebral blood flow in hypotensive newborn pigs. *Am. J. Physiol.* **254** (*Heart Circ. Physiol.* **23**), H671–H677.
- Bain, W.H. (1988). Measurement and monitoring for cardiopulmonary bypass. In “Cardiopulmonary Bypass.” (K.M. Taylor, ed.), pp 13–28. Chapman and Hall Ltd., London.
- Becker, M. (1986). Anesthesia in Göttingen miniature swine used for experimental surgery. *Lab. Anim. Sci.* **36**(4), 417–419.
- Belanger, M., Wittnich, C., Torrance, S., and Juhasz, S. (2003). Model of normothermic long-term cardiopulmonary bypass in swine weighing more than eighty kilograms. *Comp. Med.* **52**(2), 117–121.
- Benharkate, M., Zanini, V., Blanc, R., Boucheix, O., Coyez, F., Genevois, J.P., and Pairet, M. (1993). Hemodynamic parameters of anesthetized pigs: A comparative study of farm piglets and Gottingen and Yucatan miniature swine. *Lab. Anim. Sci.* **43**(1), 68–72.
- Benson, G.J., and Thurmon, J.C. (1979). Anesthesia of swine under field conditions. *J. Am. Vet. Med. Assoc.* **174**, 594–596.
- Blum, J.R. (1988). Laboratory animal anesthesia. In “Experimental Surgery and Physiology: Induced Animal Models of Human Disease.” (M.M. Swindle and R.J. Adams, eds.), pp 329–345. Williams and Wilkins, Baltimore, MD.
- Bobbie, D.L., and Swindle, M.M. (1986). Pulse monitoring, intravascular and intramuscular injection sites in pigs. In “Swine in Biomedical Research.” (M.E. Tumbleson, ed.), Vol. 1, pp 273–277. Plenum Publishers, New York.
- Bolin, S.R., and Runnels, L.J. (1992). Chemical restraint and anesthesia. In “Diseases of Swine—Seventh Edition.” (A.D. Leman, B. Straw, R.D. Glock, W.L. Mengeling, R.H.C. Penny, and E. Scholl), Iowa State University Press, Ames, IA.
- Bollen, P.J.A., Hansen, A.K., Rasmussen, H.J., and Suckow, M.A. (2000). “The Laboratory Swine.” CRC Press, Boca Raton, FL.
- Boschert, K., Flecknell, P.A., Fosse, R.T., Framstad, T., Ganter, M., Sjøstrand, U., Stevens, J., and Thurmon, J. (1996). Ketamine and its use in the pig. *Lab. Anim.* **30**(2), 209–219.
- Braimbridge, M.V. (1988). Myocardial protection ?hypothermia and cardioplegia. In “Cardiopulmonary Bypass.” (K.M. Taylor, ed.), pp 375–392. Chapman and Hall Ltd. London.
- Branson, K.R., and Gross, M.E. (2001). Opioid agonists and antagonists. In “Veterinary Pharmacology and Therapeutics.” (H.R. Adams, ed.), pp 268–298. Iowa State University Press, Ames, IA.
- Breese, C.E., and Dodman, N.H. (1984). Xylazine-ketamine-oxymorphone: An injectable anesthetic combination in swine. *J. Am. Vet. Med. Assoc.* **184**, 182–183.
- Buckley, N.M., Gootman, P.M., Brazeau, P., Matanic, B.P., Frasier, I.D., and Gentles, E.L. (1979). Cardiovascular function in anesthetized miniature swine. *Lab. Anim. Sci.* **29**, 200–208.
- Buylaert, W.A., Herregods, L.L., Mortier, E.P., and Bogaert, M.G. (1989). Cardiopulmonary bypass and the pharmacokinetics of drugs: An update. *Clin. Pharmacokinet.* **17**, 10–26.
- Cameron, D.E., Tam, V.K.H., Cheng, W., and Braxton, M. (1992). Studies in the physiology of cardiopulmonary bypass using a swine model. In “Swine as Models in Biomedical Research.” (M.M. Swindle, ed.), pp 185–196. Iowa State University Press, Ames, IA.
- Cantor, G.H., Brunson, D.B., and Reibold, T.W. (1981). A comparison of four short-acting anesthetic combinations for swine. *Vet. Med. Small Anim. Clin.* **76**, 715–720.
- Cheng, D., Mayers, J., Knutson, R., Gomez, M.N., and Tinker, J.H. (1992). Dose-response relationship of isoflurane and halothane versus coronary perfusion pressures. *Anesthesiology* **76**, 113–122.
- Crane, L., Gootman, N., and Gootman, P.M. (1975). Age-dependent cardiovascular effects of halothane anesthesia in neonatal pigs. *Arch. Int. Pharmacodyn.* **214**, 180–187.
- Danneberg, P., Bauer, R., Boke-Kuhn, K., Hoefke, W., Kuhn, F.J., Lehr, E., and Walland, A. (1986). “General Pharmacology of Brotizolam in Animals.” Department of Pharmacology, Boehringer Ingelheim KG, Ingelheim/Rhein (Federal Republic of Germany).
- Eger, E., Johnson, B., Weiskopf, R., Holmes, M., Yasuda, N., and Targ, A. (1988). Minimum alveolar concentration of I-653 and isoflurane in pigs: Definition of a supramaximal stimulus. *Anesth. Analg.* **67**, 1174–1176.
- Ehler, W.J., Mack, J.W., Jr., Brown, D.L., and Davis, R.F. (1985). Avoidance of malignant hyperthermia in a porcine model for experimental open heart surgery. *Lab. Anim. Sci.* **35**, 172–175.
- Eisele, P.H., Talken, L., and Eisele, J.H. (1985). Potency of isoflurane and nitrous oxide in conventional swine. *Lab. Anim. Sci.* **35**, 76–78.
- Eisele, P.H., Woodle, E.S., Hunter, G.C., Talken, L., and Ward, R.E. (1986). Anesthetic, preoperative and postoperative considerations for liver transplantation in swine. *Lab. Anim. Sci.* **36**, 402–405.
- Endo, M. (1977). Calcium release from the sarcoplasmic reticulum. *Physiol. Rev.* **57**, 71–108.
- Flecknell, P.A. (1984). The relief of pain in laboratory animals. *Lab. Anim.* **18**, 147–160.

- Flecknell, P.A. (1987). "Laboratory Animal Anaesthesia." Academic Press, NY.
- Flecknell, P.A. (1996). "Laboratory Animal Anaesthesia," 2nd ed. Academic Press, New York.
- Flecknell, P.A. (1997). Medetomidine and antipamezole: Potential uses in laboratory animals. *Lab. Anim.* **26**(2), 21–25.
- Flewellen, E.H., and Nelson, T.E. (1982). Masseter spasm induced succinylcholine in children: Contracture testing for malignant hyperthermia: Report of six cases. *Can. J. Anaesth.* **29**, 42–48.
- Foster, P.S., Hopkinson, K.C., and Denborough, M.A. (1992). Propofol anaesthesia in malignant hyperpyrexia susceptible swine. *Clin. Exp. Pharmacol. Physiol.* **19**, 183–186.
- Fuji, J., Ostiu, K., Zorzato, F., deLeon, S., Khanna, V.K., Weiler, J.E., O'Brien, P.J., and MacLennan, D.H. (1991). Identification of a mutation in porcine ryanodine receptor associated with malignant hyperthermia. *Science* **253**, 448–451.
- Gaymes, C.H., Swindle, M.M., Gillette, P.C., Harold, M.E., and Schumann, R.E. (1995). Percutaneous serial catheterization in swine: A practical approach. *J. Invest. Surg.* **8**(2), 123–128.
- Geers, R., Decanniere, C., Ville, H., Van Hecke, P., Goedseels, V., Bosschaerts, L., Deley, J., Janssens, S., and Nierynck, W. (1992). Identification of halothane gene carriers by use of an in vivo 31P nuclear magnetic resonance spectroscopy in pigs. *Am. J. Vet. Res.* **53**(9), 1711–1714.
- Gelman, S., Dillard, E., and Bradley, E.L. (1987). Hepatic circulation during surgical stress and anesthesia with halothane, isoflurane, or fentanyl. *Anesth. Analg.* **66**, 936–43.
- Gilbert, M., Mori, M., and Myhre, E. (1989). Hemodynamic dose-responses to halothane and isoflurane are different in swine with and without critical coronary artery stenosis. *Anesth. Analg.* **68**, 752–758.
- Gilbert, M., Roberts, S., Mori, M., Blomberg, R., and Tinker, J.H. (1988). Comparative coronary vascular reactivity and hemodynamics during halothane and isoflurane anesthesia in swine. *Anesthesiology* **68**, 243–253.
- Glen, J.B., Davies, G.E., Thomson, D.S., Scarth, S.C., and Thompson, A.V. (1979). An animal model for the investigation of adverse responses to IV anaesthetic agents and their solvents. *Br. J. Anaesth.* **51**, 819–827.
- Goldmann, C., Ghofrani, A., Hafemann, B., Fuchs, P., Khorram-Seffat, R., Afify, M., Kupper, W., and Pallus, N. (1999). Combination anesthesia with ketamine and pentobarbital: A long-term porcine model. *Res. Exp. Med.* **199**(1), 35–50.
- Goodrich, J.A., Lackland, D.T., Del Signore, M.J., and Swindle, M.M. (2001). Non-invasive measurement of blood pressures in the Yucatan micropig, with and without midazolam-induced sedation. *Comp. Med.* **51**(1), 13–15.
- Gootman, N., Gootman, P.M., Buckley, B.J., and Buckley, N.M. (1986). Cardiovascular effects of catecholamine infusions in developing swine. In "Swine in Biomedical Research." (M.E. Tumbleson, ed.), Vol. 3, pp 1615–1622. Plenum Publishers, New York.
- Gravlee, G.P. (1991a). Management of cardiopulmonary bypass. *American Society of Anesthesiology*, 1991 Annual Refresher Course Lectures, #176, pp 1–7. San Francisco, California.
- Gravlee, G.P. (1991b). Heparin monitoring for cardiopulmonary bypass. Does it really matter?. *Anesthesiology* **5**, 21.
- Gravlee, G.P. (1993a). The anesthesiologist and management of cardiopulmonary bypass. In "American Society of Anesthesiologists Annual Refresher Course Lecture, Washington, DC," Vol. 126, pp 1–7.
- Gravlee, G.P. (1993b). Cardiopulmonary bypass circuitry and cannulation techniques. In "Utley Cardiopulmonary Bypass: Principles and Practice," Gravlee, Davis, Williams and Wilkins, Baltimore, MD.
- Greene, S.A., Benson, G.J., Tranquilli, W.J., and Grimm, K.A. (2004). Effect of isoflurane, atacurium, fentanyl, and noxious stimulation on bispectral index in pigs. *Comp. Med.* **54**(4), 397–403.
- Gronert, G.A., Milde, J.A., and Theye, P.A. (1976). Dantrolene in porcine malignant hyperthermia. *Anesthesiology* **44**, 488–495.
- Gronert, G.A. (1980). Malignant hyperthermia. *Anesthesiology* **53**(5), 395–423.
- Gross, M.E. (2001). Tranquilizers, α 2 adrenergic agonists, and related agents. In "Veterinary Pharmacology and Therapeutics." (H.R. Adams, ed.), pp 299–342. Iowa State University Press, Ames, IA.
- Hall, G.M., Lucke, J.N., and Lister, D. (1976). Porcine malignant hyperthermia IV: Neuromuscular blockade. *Br. J. Anaesth.* **48**, 1135–1141.
- Hall, G.M., Young, C., Holdcroft, A., and Alaghand-Zadeh, J. (1978). Substrate mobilization during surgery. A comparison between halothane and fentanyl anesthesia. *Anesthesiology* **33**, 924–931.
- Halsey, M.J., Sawyer, D.C., Eger, E.I., Bahlman, S.H., and Impelman, D.M.K. (1971). Hepatic metabolism of halothane, methoxyflurane, cyclopropane, ethrane, and forane in miniature swine. *Anesthesiology* **35**, 43–47.
- Hanneman, S.K., Clubb, F.J., Jr., McKay, K., and Costas, G. (2004). Feasibility of a porcine adult intensive care model. *Comp. Med.* **54**(1), 36–43.
- Harvey-Clark, C.J., Giles, K., and Riggs, K.W. (2000). Transdermal fentanyl compared with parenteral buprenorphine in post-surgical pain in swine: A case study. *Lab. Anim.* **34**(4), 386–398.
- Hawk, C.T., Leary, S.L., and Morris, T.H. (2005). "Formulary for Laboratory Animals." 3rd ed., Blackwell Publishing, Ames, IA.
- Hecker, K.E., Baumert, J.H., Horn, N., Reyle-Hahn, M., Heussen, N., and Rossaint, R. (2003). Minimum anesthetic concentration of sevoflurane with different xenon concentrations in swine. *Anesth. Analg.* **97**, 1364–1369.
- Hermansen, K., Pedersen, L.E., and Olesen, H.O. (1986). The analgesic effect of buprenorphine, etorphine and pethidine in the pig: A randomized double blind cross-over study. *Acta Pharmacol. Toxicol.* **59**(1), 27–35.
- Holley, F.O., Ponganis, K.V., and Stanski, D.R. (1982). Effect of cardiopulmonary bypass in the pharmacokinetics of drugs. *Clin. Pharmacokinet.* **7**, 234–251.
- Holmes, M., Weiskopf, R., Eger, E., Johnson, B.H., and Rampil, I.J. (1990). Hepatocellular integrity in swine after prolonged desflurane (I-653) and isoflurane anesthesia: Evaluation of plasma alanine aminotransferase activity. *Anesth. Analg.* **71**, 249–253.
- Holmström, A., Rosén, I., and Åkeson, J. (2004). Desflurane results in higher cerebral blood flow than sevoflurane or isoflurane at hypocapnia in pigs. *Acta Anaesthesiol. Scand.* **48**, 400–404.
- Holzchuh, M.P., and Cremonesi, E. (1991). Anaesthesia in pigs. Analysis of azaperone and etomidate effects separately and in associations. Proceedings of the 4th International Congress of Veterinary Anaesthesia, Utrecht, The Netherlands, pp 197–200.
- Houde, A., Pommier, S.A., and Roy, R. (1993). Detection of the Ryanodine receptor mutation associated with malignant hyperthermia in purebred swine populations. *J. Anim. Sci.* **71**(6), 1414–1418.
- Haupt, T.R. (1986). The handling of swine in research. In "Swine in Cardiovascular Research." (H.C. Stanton and H.J. Mersmann, eds.), Vol. 1. pp 25–38. CRC Press, Boca Raton, FL.
- Hoyt, R.F., Jr., Hayre, M.D., Dodd, K.T., and Phillips, Y.Y. (1986). Long acting intramuscular anesthetic regimen for swine. *Lab. Anim. Sci.* **36**(4), 413–416.
- Hudson, L.C., and Gilroy, B.A. (1986). Percutaneous transtracheal ventilation in swine. *Lab. Anim. Sci.* **36**(4), 420–424.
- Kaiser, G.M., Fruhauf, N.R., Zhang, H., Westermann, S., Bolle, I., Oldhafer, K.J., and Broelsch, C.E. (2003). Intravenous infusion anesthesia with propofol-midazolam-fentanyl for experimental surgery in swine. *J. Invest. Surg.* **16**(6), 353–7.
- Kaiser, G.M., Heuer, M.M., Fruhauf, N.R., Kuhne, C.A., and Broelsch, C.E. (2006). General handling and anaesthesia for experimental surgery in pigs. *J. Surg. Res.* **130**(1), 73–79.
- Kaplan, R.F. (1991). Malignant hyperthermia. ASA, 1991 Annual Refresher Course Lectures, San Francisco, CA, Vol. 231, pp 1–7.
- Karzai, W., Haberstroh, J., Muller, W., and Priebe, H.J. (1997). Rapid increase in inspired desflurane concentration does not elicit a hyperdynamic circulatory response in the pig. *Lab. Anim.* **31**(3), 279–282.
- Kerbaul, F., Bellezza, M., Guidon, C., Roussel, L., Imbert, M., Carpentier, J.P., and Auffray, J.P. (2000). Effects of sevoflurane on hypoxic pulmonary vasoconstriction in anaesthetized piglets. *Br. J. Anaesth.* **85**(3), 440–445.

- Ko, J.C.H., Williams, B.L., McGrath, C.J., Short, C.E., and Rogers, E.R. (1977). Comparison of anesthetic effects of Telazol-xylazine-xylazine, Telazol-xylazine-butorphanol, and Telazol-xylazine-azaperone combinations in swine. *Contemp. Top. Lab. Anim. Sci.* **35**(5), 71–74.
- Ko, J.C.H., Williams, B.L., Smith V.L., McGrath, C.J., and Jacobson, J.D. (1993). Comparison of Telazol, Telazol-Ketamine, Telazol-Xylazine and Telazol-Ketamine-Xylazine as chemical restraint and anesthetic induction combination in swine. *Lab. Anim. Sci.* **43**(5), 476–480.
- Koblin, P., Weiskopf, R., Holmes, M., Konopka, K., Rampil, I.J., Eger, E.I., and Waskell, L. (1989). Metabolism of I-653 and isoflurane in swine. *Anesth. Analg.* **68**, 147–149.
- Kreimeier, U., Brueckner, U.B., Gerspach, S., Veitinger, K., and Messmer, K. (1993). A porcine model of hyperdynamic endotoxemia: Patterns of respiratory, macrocirculatory, and regional blood flow changes. *J. Invest. Surg.* **6**(2), 143–156.
- Kyle, O.C., Novak, S., and Bolooki, H. (1979). General anesthesia in pigs. *Lab. Anim. Sci.* **29**, 123–124.
- Li, J., Stenbøg, E., Bush, A., Grofte, T., Redington, A.N., and Penny, D.J. (2004). Insulin-like growth factor 1 improves the relationship between systemic oxygen consumption and delivery in piglets after cardiopulmonary bypass. *J. Thorac. Cardiovasc. Surg.* **127**(5), 1436–1441.
- Littleford, J.A., Patel, L.R., Bose, D., Cameron, C.B., and McKillop, C. (1991). Masseter muscle spasm in children implications of continuing the triggering anesthetic. *Anesth. Analg.* **72**, 151–160.
- Lopez, J.R., Allen, P.D., Jones, D., and Streter, F.A. (1988). Myoplasmic free $[Ca^{++}]$ during a malignant hyperthermia episode in swine. *Muscle Nerve* **11**, 82–88.
- Loscher, W., Ganter, M., and Fassbender, C.P. (1990). Correlation between drug and metabolite concentrations in plasma and anesthetic action of ketamine in swine. *Am. J. Vet. Res.* **51**, 391–398.
- Lundeen, G., Manohar, M., and Parks, C. (1983). Systemic distribution of blood flow in swine while awake and during 1.0 and 1.5 MAC isoflurane anesthesia with or without 50% nitrous oxide. *Anesth. Analg.* **62**, 499–512.
- Lunn, J.K., Stanley, T.M., Eisele, J., Webster, L., and Woodward, A. (1979). High dose fentanyl anesthesia for coronary surgery: Plasma fentanyl concentrations and influence of nitrous oxide on cardiovascular responses. *Anesth. Analg.* **58**, 390–405.
- Manohar, M., and Parks, C. (1984a). Porcine regional brain and myocardial blood flows during halothane-02 and halothane-nitrous oxide anesthesia: Comparisons with equipotent isoflurane anesthesia. *Am. J. Vet. Res.* **45**(3), 465–473.
- Manohar, M., and Parks, C. (1984b). Regional distribution of brain and myocardial perfusion in swine while awake and during 1.0 and 1.5 MAC isoflurane anaesthesia produced without or with 50% nitrous oxide. *Cardiovas. Res.* **18**, 344–353.
- Manohar, M., and Parks, C.M. (1984c). Porcine systemic and regional organ blood flow during 1.0 and 1.5 minimum alveolar concentrations of sevoflurane anesthesia without and with 50% nitrous oxide. *J. Pharmacol. Exp. Therapeut.* **231**(3), 640–648.
- Martin-Cancho, M.F., Carrasco-Jimenez, M.S., Lima, J.R., Ezquerro, L.J., Crisostomo, V., and Uson-Gargallo, J. (2004). Assessment of the relationship of bispectral index values, hemodynamic changes, and recovery times associated with sevoflurane or propofol anesthesia in pigs. *Am. J. Vet. Res.* **65**(4), 409–416.
- Martin-Cancho, M.F., Lima, J.R., Crisostomo, V., Ezquerro, L.J., Carrasco, M.S., and Uson-Gargallo, J. (2003). Bispectral index, spectral edge frequency 95%, and median frequency recorded for various concentrations of isoflurane and sevoflurane in pigs. *Am. J. Vet. Res.* **64**(7), 866–873.
- Merin, R.G., Verdouw, P.D., and Jong, J.W. (1982). Myocardial functional and metabolic responses to ischemia in swine during halothane and fentanyl anesthesia. *Anesthesiology* **56**, 84–92.
- Mickelson, J.R., Gallant, E.M., Litterer, L.A., Johnson, K.M., Rempel, W.E., and Louis, C.F. (1988). Abnormal sarcoplasmic reticulum ryanodine receptor in malignant hyperthermia. *J. Biol. Chem.* **263**, 9310–9315.
- Moffitt, E.A., Kirklín, J.W., and Theye, R.A. (1962). Physiologic studies during whole body perfusion in Tetralogy of Fallot. *J. Thorac. Cardiovasc. Surg.* **44**, 180.
- Mohr, M., Vicol, C., Mensing, B., Schunck, O., Baryalei, M., Dalichau, H., and Sonntag, H. (1996). A technique for extracorporeal circulation in the Göttingen minipig allowing recovery and long-term follow-up. *J. Exp. Anim. Sci.* **38**(2), 82–92.
- Natalini, C.C. (2001). Sevoflurane, desflurane, and xenon new inhaled anesthetics in veterinary medicine. *Cienc. Rural* **31**(1), 177–183.
- Nishijima, M.K., Breslow, M.J., Miller, C.F., and Traystman, R.J. (1988). Effect of naloxone and iluprofen on organ blood flow during endotoxic shock in pig. *Am. J. Physiol.* **255** H177–H184.
- Ochs, R., Greenblatt, D.J., Eichelkraut, W., Bakker C., Gobel, R., and Hahn, N. (1987). Hepatic vs. gastrointestinal presystemic extraction of oral midazolam and flurazepam. *J. Pharmacol. Exp. Ther.* **243**(3), 852–856.
- Okutani, R., Philbin, D.M., Rosow, C.E., Koski, G., and Schneider, R.C. (1988). Effect of hypothermic hemodilutional cardiopulmonary bypass on plasma sufentanil and catecholamine concentrations in humans. *Anesth. Analg.* **67**, 667–670.
- Oldhafer, K.J., Hauss, J., Gubernatis, G., Pichlmayr, R., and Spiegel, H.U. (1993). Liver transplantation in pigs: A model for studying reperfusion injury. *J. Invest. Surg.* **6**(5), 439–450.
- Panepinto, L.M., Phillips, R.W., Norden, S.W., Pryor, P.C., and Cox, R. (1983). A comfortable minimum stress method of restraint for Yucatan miniature swine. *Lab. Anim. Sci.* **33**, 95.
- Pender, E.S., Pollack, C.V., Woodall, B.N., and Parks, B.R. (1991). Intraosseous administration of lorazepam: Same-dose comparison with intravenous administration in the weanling pig. *J. MSMA* 365–368.
- Pokela, M., Romsí, P., Biancari, F., Kiviluoma, K., Vainionpää, V., Heikkinen, J., Ronka, E., Kaakinen, T., Hirvonen, J., Rimpiläinen, J., Anttila, V., Leo, E., and Juvonen, T. (2002). Increase of intracranial pressure after hypothermic circulatory arrest in a chronic porcine model. *Scand. Cardiovasc. J.* **36**(5), 302–307.
- Pond, W.G., and Mersmann, H.J. (2001). “Biology of the Domestic Pig.” Comstock Publishing Associates, Ithaca, NY.
- Portier, D.B., and Slusser, C.A. (1985). Azaperone: A review of a new neuroleptic agent for swine. *Vet. Med.* **80**(3), 88–92.
- Priebe, H.J. (1989). Isoflurane and coronary hemodynamics. *Anesthesiology* **71**, 960–976.
- Putney, J.W., Jr. (1979). Stimulus–permeability coupling: Role of calcium in the receptor regulation of membrane permeability. *Pharmacol. Rev.* **30**, 209–245.
- Quintin, L., Whalley, D.G., Wynands, J.E., Morin, J.E., and Burke, J. (1981). High dose fentanyl anesthesia with oxygen for aorta-coronary bypass surgery. *Can. Anaesth. Soc. J.* **28**, 314–320.
- Raff, M., and Harrison, G. (1989). The screening of propofol in MHS swine. *Anesth. Analg.* **68**, 750–751.
- Rampil, I., Weiskopf, R., Brown, J., Eger, E., Johnson, B., Holmes, M., and Donegan, J. (1988). I653 and isoflurane produce similar dose-related changes in the electroencephalogram of pigs. *Anesthesiology* **69**, 298–302.
- Ramsey, D.E., Aldred, N., and Power, J.M. (1993). A simplified approach to the anesthesia of porcine laparoscopic surgical subjects. *Lab. Anim. Sci.* **43**(4), 336–337.
- Reed, C.C., and Stafford, T.B. (1989). Myocardial protection. In “Cardiopulmonary Bypass.” 2nd ed., pp 415–426. The Woodlands, Surgimedics/TMP, TX.
- Reves, J.G., Croughwell, N., Jacobs, J.R., and Greeley, W. (1989). Anesthesia during cardiopulmonary bypass: Does it matter? In “Cardiopulmonary Bypass: Current Concepts and Controversies.” (J.H. Tinker, ed.), pp 69–98. W.B. Saunders, Philadelphia, PA.
- Riebold, T.W., Goble, D.O., and Geiser, D.R. (1995). “Large Animal Anesthesia: Principles and Techniques.” 2nd ed., Iowa State University Press, Ames, IA.
- Riebold, T.W., and Thurmon, J.C. (1986). Anesthesia in swine. In “Swine in Biomedical Research.” (M.E. Tumbleson), Vol. 1, pp 243–254. Plenum Press, New York.

- Riou, B., Rimailho, A., Galliot, M., Bourdon, R., and Huet, Y. (1988). Protective cardiovascular effects of diazepam in experimental acute chloroquine poisoning. *Intensive Care Med.* **4**, 610–616.
- Rittenhouse, E.A., Mohri, H., Dillard, D.H., and Merendino, K.A. (1974). Deep hypothermia in cardiovascular surgery. *Ann. Thorac. Surg.* **17**, 63–98.
- Roberts, S., Gilbert, M., and Tinker, J. (1987). Isoflurane has a greater margin of safety in swine with and without major surgery or critical coronary stenosis. *Anesth. Analg.* **66**, 485–491.
- Rodriguez, N.A., Cooper, D.M., and Risdahl, J.M. (2001). Antinociceptive activity of and clinical experience with buprenorphine in swine. *Contemp. Top. Lab. Anim. Sci.* **40**(3), 17–20.
- Rogers, G.P., Cromeens, D.M., Minor, S.T., and Swindle, M.M. (1988). Bretylium and diltiazem in porcine cardiac procedures. *J. Invest. Surg.* **1**(4), 321–326.
- Rosenberg, H. (1988). Management of patients in whom trismus occurs following succinylcholine. *Anesthesiology* **68**, 653–654.
- Scarda, R.T. (1996). Local and regional anesthesia in ruminants and swine. Anesthesia update. *Vet. Clin. North Am.* **12**(3), 579–626.
- Schieber, R.A., Namnoum, A., Sugden, A., Shiu, G.K., Orr, R., and Cook, D. (1986). Hemodynamic effects of isoflurane in the newborn piglet: Comparison with halothane. *Anesth. Analg.* **65**, 633–638.
- Schneider, R., and Mitchell, D. (1976). Dantrolene hepatitis. *JAMA* **235**, 1590–1601.
- Schranz, D., Huth, R.G., Stopfkuchen, H., and Jungst, B.K. (1988). The effect of nifedipine alone or combined with low dose acetylsalicylic acid on endotoxin-induced pulmonary hypertension in the piglet. *Intensive Care Med.* **14**, 595–601.
- Schumann, R.E., Harold, M., Gillette, P.C., Swindle, M.M., and Gaymes, C.H. (1993). Prophylactic treatment of swine with bretylium for experimental cardiac catheterization. *Lab. Anim. Sci.* **43**(3), 244–246.
- Schumann, R.E., Swindle, M.M., Knick, B.J., Case, C.L., and Gillette, P.C. (1994). High dose narcotic anesthesia using sufentanil in swine for cardiac catheterization and electrophysiologic studies. *J. Invest. Surg.* **7**(3), 243–248.
- Short, C.E. (ed.). (1987). “Principles and Practice of Veterinary Anesthesia.” Williams & Wilkins, Baltimore, MD.
- Short, C.E., Paddleford, R.R., McGrath, C.J., and Williams, C.H. (1976). Pre-anesthetic evaluation and management of malignant hyperthermia in the pig experimental model. *Anesth. Analg.* **55**, 643–653.
- Silverman, J., and Muir, W.W. III. (1993). A review of lab animal anesthesia with chloral hydrate and chloralose. *Lab. Anim. Sci.* **43**(3), 210–216.
- Slogoff, S., and Keats, A.S. (1989). Randomized trial of primary anesthetic agents on outcome of coronary artery bypass operations. *Anesthesiology* **70**, 179–188.
- Smerup, M., Pedersen, T.F., Nyboe, C., Funder, J.A., Christensen, T.D., Nielsen, S.L., Hjortdal, V., and Hasenkam, J.M. (2004). A long-term porcine model for evaluation of prosthetic heart valves. *Heart Surg. Forum.* **7**(4), E259–E264.
- Smith, A.C., Spinale, F.G., Carabello, B.A., and Swindle, M.M. (1989). Technical aspects of cardiac catheterization of swine. *J. Invest. Surg.* **2**(2), 187–194.
- Smith, A.C., Spinale, F.G., and Swindle, M.M. (1990). Cardiac function and morphology of Hanford miniature swine and Yucatan miniature and micro swine. *Lab. Anim. Sci.* **40**(1), 47–50.
- Smith, A.C., Zellner, J.L., Spinale, F.G., and Swindle, M.M. (1991). Sedative and cardiovascular effects of midazolam in swine. *Lab. Anim. Sci.* **41**(2), 157–161.
- Stanton, H.C., and Mersmann, H.J. (1986). “Swine in Cardiovascular Research.” Vol. 1, pp 39–59. CRC Press, Inc., Boca Raton, FL.
- Steffey, E.P., and Eger, E.I. (1985). Nitrous oxide in veterinary practice and animal research. In “Nitrous Oxide.” pp 305–312. Elsevier, New York.
- St-Jean, G., and Anderson, D.E. (1999). Anesthesia and surgical procedures in swine. In “Diseases of Swine.” (B.E. Straw, S. D’Allaire, W.L. Mengeling, and D.J. Taylor, eds.), 8th ed., pp 1133–1154. Iowa State University Press, Ames, IA.
- Svendsen, P., and Carter, A.M. (1989). Blood gas tensions, acid-base status and cardiovascular function in miniature swine anaesthetized with halothane and methoxyflurane or intravenous metomidate hydrochloride. *Pharmacol. Toxicol.* **64**, 88–93.
- Swindle, M.M. (1985). “Anesthesia in Swine.” CRL Technical Bulletin, Vol. 3, p 3. Charles River Laboratories, Wilmington, MA.
- Swindle, M.M. (ed.). (1986). Surgery and anesthesia. In “Swine in Biomedical Research”. (M.E. Tumbleson, ed.), pp 233–433. Plenum Press, New York.
- Swindle, M.M. (1991a). “Anesthetic and Perioperative Techniques in Swine.” CRL Technical Bulletin (Winter). Charles River Laboratories, Wilmington, MA.
- Swindle, M.M. (1991b). “Anesthetic and Perioperative Techniques in Swine.” Charles River Digest, Vol. 9, p 1.
- Swindle, M.M. (1998). “Surgery, Anesthesia and Experimental Techniques in Swine”, Iowa State University Press, Ames, IA.
- Swindle, M.M. (2007). “Swine in the Laboratory: Surgery, Anesthesia, Imaging and Experimental Techniques,” 2nd ed., CRC Press, Boca Raton, FL.
- Swindle, M.M., and Bobbie, D.L. (Illustrator). (1983). “Basic Surgical Exercises Using Swine.” Praeger Publishers, New York.
- Swindle, M.M., Horneffer, P.J., Gardner, T.J., Gott, V.L., Hall, T.S., Stuart, R.S., Baumgartner, W.A., Borkon, A.M., Galloway, E., and Reitz, B.A. (1986). Anatomic and anesthetic considerations in experimental cardiopulmonary surgery in swine. *Lab. Anim. Sci.* **36**(4), 357–361.
- Swindle, M.M., Schumann, R.E., Johnson, W.S., Knick, B., Smith, A.C., Carabello, B.A., Zile, M., Case, C.L., and Gillette, P.C. (1993). High dose narcotic anesthesia using sufentanil in swine and dogs. In “Proceedings of the 4th International Conference of Veterinary Anesthesia.” (L.W. Hall, ed.), pp 273–276. Journal of Veterinary Anesthesia (Special Supplement), Utrecht, NTH.
- Swindle, M.M., Smith, A.C., and Hepburn, B.J.S. (1988). Swine as models in experimental surgery. *J. Invest. Surg.* **1**(1), 65–79.
- Taylor, K.M. (ed.). (1988). “Cardiopulmonary Bypass.” Chapman and Hall Ltd, London.
- Thurmon, J.C., and Tranquilli, W.J. (1986). Anesthesia for cardiovascular research. In “Swine in Cardiovascular Research.” (C.E. Short, H.C. Stanton, and H.J. Mersmann, eds.), Vol. 1, pp 39–59. CRC Press, Boca Raton, FL.
- Thurmon, J.C., Tranquilli, W.J., and Benson, G.J. (1986). Cardiopulmonary responses of swine to intravenous infusion of guaifenesin, ketamine, and xylazine. *Am. J. Vet. Res.* **47**, 2138–2140.
- Tranquilli, W.J., Parks, C.M., Thurmon, J.C., Benson, G.J., Koritz, G.D., Manohar, M., and Theodorakis, M.C. (1982). Organ blood flow and distribution of cardiac output in nonanesthetized swine. *Am. J. Vet. Res.* **43**, 895–897.
- Tranquilli, W.J., Thurman, J.C., and Benson, G.J. (1985). Anesthetic potency of nitrous oxide in young swine (*Sus scrofa*). *Am. J. Vet. Res.* **46**, 58–60.
- Tranquilli, W., Thurmon, J., and Benson, G. (1986). Halothane-cathechalomine arrhythmias in swine (*Sus scrofa*). *Am. J. Vet. Res.* **47**(10), 2134–2137.
- Tranquilli, W.J., Thurmon, J.C., Benson, G.J., and Steffey, E.P. (1988). Determination of halothane MAC in swine. *Anesth. Analg.* **67**, 597–598.
- Trim, C.M., and Gilroy, G.A. (1985). Cardiopulmonary effects of a xylazine and ketamine combination in pigs. *Res. Vet. Sci.* **38**, 30–34.
- Trudeau, V.L., Meijer, J.C., van de Wiel, D.F.M., and Bevers, M.M. (1988). Effects of morphine and naloxone on plasma levels of LH, FSH, prolactin and growth hormone in the miniature male pig. *J. Endocr.* **119**, 501–508.
- Tuman, K.J., McCarthy, R.J., Spless, B.D., DaValle, M., Dabir, R., and Ivankovich, A.D. (1989). Does choice of anesthetic agent significantly affect outcome after coronary artery surgery? *Anesthesiology* **70**, 189–198.
- Tumbleson, M.E., and Schook, L.B. (eds.). (1996). “Advances in Swine in Biomedical Research,” Vol. 1–2. Plenum Press, New York.
- Vainio, O.M., Bloor, B.C., and Kim, C. (1992). Cardiovascular effects of a ketamine-medetomidine combination that produces deep sedation in Yucatan mini swine. *Lab. Anim. Sci.* **42**(6), 582–588.

- Wedel, D., Iaizzo, P., and Milde, J. (1991). Desflurane is a trigger of malignant hyperthermia in susceptible swine. *Anesthesiology* **74**, 508–512.
- Weiskopf, R., Eger, E., Holmes, M., Rampil, I.J., Johnson, B., Brown, J.G., Yasuda, N., and Targ, A.G. (1989a). Epinephrine-induced premature ventricular contractions and changes in arterial blood pressure and heart rate during I-653, isoflurane and halothane anesthesia in swine. *Anesthesiology* **70**, 293–298.
- Weiskopf, R., Eger, E., Holmes, M., Yasuda, N., Johnson, B.H., and Targ, A.G. (1990). Cardiovascular actions of common anesthetic adjuvants during desflurane (I-653) and isoflurane anesthesia in swine. *Anesth. Analg.* **71**, 144–148.
- Weiskopf, R., Holmes, M., Rampil, I., Johnson, B.H., Yasuda, N., Targ, A.G., and Eger, E.I. II. (1989b). Cardiovascular safety and actions of high concentrations of I-653 and isoflurane in swine. *Anesthesiology*, **70**, 793–798.
- Weiskopf, R., Holmes, M., Eger, E., Johnson, B.H., Rampil, I.J., and Brown, J.G. (1988). Cardiovascular effects of I653 in swine. *Anesthesiology* **69**, 303–309.
- Weiskopf, R., Holmes, M., Rampil, I., Johnson, B.H., Yasuda, N., Targ, A.G., and Eger, E.I. II. (1989). Cardiovascular safety and actions of high concentrations of I-653 and isoflurane in swine. *Anesthesiology* **70**, 793–798.
- Weiskopf, R.B., Holmes, M.A., Eger, E.I., II, Yasuda, N., Rampil, I.J., Johnson, B.H., Targ, A.G., Reid, I.A., and Keil, L.C. (1992). Use of swine in the study of anesthetics. In “Swine as Models in Biomedical Research.” Iowa State University Press, Ames, IA.
- Wilkinson, A.C., Thomas, M.L. III, and Morse, B.C. (2001). Evaluation of a transdermal fentanyl system in Yucatan miniature pigs. *Contemp. Top. Lab. Anim. Sci.* **40**(3), 12–16.
- Worek, F.S., Blumel, G., Zeravik, J., Zimmerman, G.J., and Pfeiffer, U.J. (1988). Comparison of ketamine and pentobarbital anesthesia with the conscious state in a porcine model of *Pseudomonas aeruginosa* septicemia. *Acta Anesth. Scand.* **32**, 509–515.

Section IV

**Practical Anesthesia and Analgesia of
Nontraditional Laboratory Animal Species**

This page intentionally left blank

Anesthesia and Analgesia in Ferrets

Jeff Ko and Robert P. Marini

I. Introduction	443
II. Preanesthetic Considerations	444
A. Physical Status and Anesthetic Selection	444
B. Preanesthetic Evaluation and Blood Work	444
III. Anesthetic Techniques	444
A. Physical Restraint, Catheter Placement, Drug Administration, and Endotracheal Intubation	444
IV. Preanesthesia: Sedative and Analgesic Drugs in Ferrets	445
A. Acepromazine, Diazepam, Midazolam, Xylazine, Medetomidine, and Dexmedetomidine	445
B. Opioids	447
C. Neuroleptic Sedative Combinations	447
D. Dissociative Injectable Combinations	448
E. Neuromuscular Blocking Agents	449
V. Anesthetic Induction and Maintenance	449
A. Injectable Anesthesia	449
B. Inhalant Anesthesia	450
VI. Monitoring Techniques	452
VII. Recovery and Pain Management	453
VIII. Special Considerations	454
A. Prolonged Anesthesia	454
B. Neonatal Anesthesia	454
IX. Authors' Preferences	454
A. Ko	454
B. Marini	455
References	455
Additional Reading	456

I. INTRODUCTION

Ferrets are useful and popular animal models for biomedical research. Many of the sedative and anesthetic agents

used in dogs and cats for anesthesia and pain management are used safely in ferrets. However, due to the higher metabolic rate, smaller body size and weight of ferrets, there are some significant differences in terms of drug dosages

and anesthetic management. The purpose of this chapter is to discuss the use of various sedatives, injectable and inhalant anesthetic combinations, as well as analgesics in ferrets. Techniques for cardiorespiratory monitoring are also covered.

II. PREANESTHETIC CONSIDERATIONS

A. Physical Status and Anesthetic Selection

The selection of the anesthetic combination depends on the physical status, age, and temperament of the ferret; the type, length, and invasiveness of procedure; and familiarity with and availability of anesthetics. In addition, anesthetic cost also plays a role in drug selection. Understanding anesthetic drug actions and effects on the cardiorespiratory system will help ensure the safety of the anesthetized ferret.

B. Preanesthetic Evaluation and Blood Work

Signalment information should include a physical examination and blood work that indicates the hydration and glycemic status, electrolyte and acid–base balance, anemia, or presence of infection. Minimal blood work for a generally healthy ferret should include a packed cell volume (PCV), total protein (TP), blood glucose (BG), and blood urea nitrogen (BUN). The physical exam should reveal a heart rate of 180–250 beats/min, a respiratory rate of 30–40 breaths/min, and a body temperature of 100–104°F (37.7–40°C). Prior to surgery and anesthesia, ferrets require only 3–4 hours of fasting, as prolonged fasting may induce a profound hypoglycemic state; gastric transit time is short in ferrets. Along with a prolonged recovery from anesthesia, this may also profoundly disturb the acid–base balance of the ferret. Dehydrated ferrets should be hydrated with lactated Ringer's solution (LRS) based on the severity of dehydration. Usually, 10 ml/kg preoperatively will alleviate dehydration in preparation for surgery. The glycemic status will help determine the volume of 5% dextrose supplementation both pre- and intraoperatively. Successful management of long, invasive procedures requires close monitoring of the perioperative glycemic status during the experiment. In addition to 5% dextrose, intraoperative LRS will maintain normal blood pressure and help alleviate the deficit from both sensible and insensible fluid lost. Alternatively, 5% dextrose in LRS will maintain euglycemia and preserve blood pressure simultaneously. Anemic ferrets should receive a blood transfusion prior to surgery. Ferrets lack discernable blood groups; cross matching is, therefore, unnecessary.

III. ANESTHETIC TECHNIQUES

A. Physical Restraint, Catheter Placement, Drug Administration, and Endotracheal Intubation

The principles for restraining a cat are also applied to the ferret. The recommended physical restraint is to scruff the ferret with one hand and hold the hindlimbs and hips with the other, gently stretching the ferret (Evans and Springsteen, 1998). Alternatively, a towel can be wrapped around the ferret while the animal is vertically suspended by the scruff with hindlimbs supported. Intravenous (IV) catheters are placed into jugular, cephalic, or lateral saphenous veins for IV drug and fluid administration (Evans and Springsteen, 1998). Tail veins have also been used for catheter placement. Ferret skin is tough and contains a large amount of subcutaneous fat (Mason, 1997), which adds to the challenge of IV catheterization. A small nick in the skin made with the beveled edge of a 20-gauge needle or a small blade will ease the insertion of the IV catheter. A short 22- or 24-gauge over-the-needle style catheter (Evans and Springsteen, 1998) should be used, though smaller ferrets may require a 26-gauge catheter instead.

Anesthetic agents are administered subcutaneously (SC) at the dorsal aspect of the neck. The thigh or expaxial muscles are used for intramuscular (IM) drug administration (Mason, 1997). For a small blood sample (e.g., for glucose measurement), percutaneous venipuncture on the lateral or caudal tail vein works well. Larger volumes may be collected from the jugular vein or cranial vena cava. Endotracheal intubation is necessary for effective administration of inhalant anesthetics, proper control of airway, and institution of positive ventilation. Endotracheal intubation is achieved following anesthetic induction. A cuffed endotracheal tube with a 3-mm internal diameter is best for ferrets weighing more than one kg. Smaller ferrets may require an uncuffed 2.5-mm or less internal diameter endotracheal tube. A straight Miller number 0 blade or a curved Macintosh number one laryngeal blade with illumination can be used to visualize the laryngeal opening of the ferret. Intubation of the ferret is very similar to that of the cat. Following anesthetic induction (except in diseased or unconscious ferrets), the ferret is held in sternal recumbency, the mouth is opened with two gauze strips, one holding the upper jaw and the other holding the lower jaw behind the canines, and the tongue is exteriorized with a cotton swab and held with a piece of gauze. The gauze strips placed behind the canines on the upper and lower jaws open the mouth while permitting maximum view of the laryngeal opening for the person who will intubate. It also prevents injury to the assistant holding the ferret's mouth in the event the plane of anesthesia is too light. A small amount of topical lidocaine spray applied at the laryngeal opening may facilitate the endotracheal intubation but is not necessary. Ferrets are less likely to have laryngeal spasms than cats. Proper intubation can be confirmed by visualizing "fogging" on the wall of the endotracheal tube, coughing

and gagging following endotracheal intubation, demonstration of condensation on a dental mirror placed at the oral end of the tube, or deflection by exhaled air of hair held at the oral end of the tube. Capnography can also be used to demonstrate the cyclic changes of CO₂ concentration which indicate proper placement of the tube.

IV. PREANESTHESIA: SEDATIVE AND ANALGESIC DRUGS IN FERRETS

Acepromazine, diazepam, midazolam, xylazine, and medetomidine have been evaluated for ferret sedation (1-6). The clinical effects and reliability of these sedatives range from minimal effect to profound sedation (Tables 16-1 and 16-2). Recently, dexmedetomidine becomes commercially available in the USA. It has been clinically evaluated by the author (Ko) in ferrets with similar outcome as those observed with medetomidine.

A. Acepromazine, Diazepam, Midazolam, Xylazine, Medetomidine, and Dexmedetomidine

Acepromazine, diazepam, midazolam, xylazine, and medetomidine have been evaluated for ferret sedation (Evans and Springsteen, 1998; Ko et al., 1997, 1998a; Marini and Fox, 1998; Mason, 1997; Morrisey et al., 1996). The clinical effects and reliability of these sedatives range from minimal effect to profound sedation (Tables 16-1 and 16-2). In ferrets, acepromazine is rapidly absorbed following IM injection (Ko et al., 1998a). Ferrets receiving acepromazine at 0.1 mg/kg in an IM injection are sedated within 3 minutes, assume lateral recumbency within 6–13 minutes of drug administration, and are immobilized (in a position of dorsal recumbency) for approximately 40–50 minutes. The rapid onset of lateral recumbency may be related to the disproportionately faster rates of drug uptake in ferrets compared to (Muir and Birchard, 1997) dogs and cats. This dose of acepromazine is adequate for ear cleaning, nail clipping, blood collection, or radiology, but is inadequate for intubation. The ferrets are completely mobile after approximately 60 minutes (Ko et al., 1998a). Higher doses of acepromazine (0.2–0.5 mg/kg, IM or SC) prolong the recovery (Ko et al., 1998a), but a lower dose of acepromazine (0.05 mg/kg, IM) is unable to induce reliable sedation in healthy ferrets (Ko et al., 1998a). Due to profound vasodilation associated with alpha-adrenergic blockade hypothermia does occur during the prolonged recovery period. Acepromazine, especially at higher doses, should be used with caution in dehydrated ferrets as it may precipitate hypotension.

Diazepam also induces a relatively quick onset of lateral recumbency in ferrets. Sedation occurs within 4–5 minutes and induces a 30- to 40-minute recumbency following diazepam (3 mg/kg, IM) administration (Ko et al., 1998a). There are

TABLE 16-1

ANALGESIC DURATIONS OF VARIOUS ANESTHETIC COMBINATIONS IN FERRETS

Drug combinations (IM)	Toe pinch analgesia (minutes)	Skin pinch analgesia (minutes)	Tail clamp analgesia (minutes)
Medetomidine (80 µg/kg)	10 ± 8	20 ± 19	16 ± 14
Medetomidine (80 µg/kg), butorphanol (0.2 mg/kg)	90 ± 4 ^a	92 ± 4 ^a	91 ± 8 ^a
Medetomidine (80 µg/kg), butorphanol (0.2 mg/kg), ketamine (5 mg/kg)	93 ± 4 ^a	91 ± 5 ^a	95 ± 0 ^a
Xylazine (2 mg/kg)	40 ± 27	32 ± 18	35 ± 17
Xylazine (2 mg/kg), butorphanol (0.2 mg/kg)	54 ± 11	43 ± 10	69 ± 5
Xylazine (2 mg/kg), butorphanol (0.2 mg/kg), ketamine (15 mg/kg)	69 ± 12	63 ± 15	81 ± 19
Diazepam (3 mg/kg)	0	0	0
Diazepam (3 mg/kg), butorphanol (0.2 mg/kg)	0	0	4 ± 9
Diazepam (3 mg/kg), butorphanol (0.2 mg/kg), ketamine (15 mg/kg)	16 ± 23	10 ± 18	20 ± 25
Acepromazine (0.1 mg/kg)	0	0	0
Acepromazine (0.1 mg/kg), butorphanol (0.2 mg/kg)	7 ± 14	2 ± 5	16 ± 19
Acepromazine (0.1 mg/kg), butorphanol (0.2 mg/kg), ketamine (15 mg/kg)	8 ± 10	7 ± 10	30 ± 26

^aIf not reversed with atipamezole. All results modified from references Brown (1997), Canadian Pediatric Society (2000), Marini (1994a), Ko (1998c). Medetomidine in this table can be replaced with 40 µg/kg of dexmedetomidine for the similar effects.

problems associated with IM administration of diazepam. The transition to lateral recumbency can be associated with excitement, restlessness, lateral pacing, anxiousness, and sensitivity to noise (Ko et al., 1998a). The large IM injection volume of diazepam (5 mg/ml) also presents a challenge due to the small muscle mass of ferrets. Treated ferrets may exhibit temporary lameness during the recovery period, presumably the result of the large injection volume as well as the propylene glycol base (Ko et al., 1998a). The poor quality of sedation and muscle relaxation, failure to achieve tolerance to intubation, resistance to ear cleaning and nail clipping, and consistent response to noise stimuli are features of diazepam administration in the ferret (Ko et al., 1998a).

Midazolam can be used in ferrets with less pain upon injection and more complete absorption following IM administration. The concentration of midazolam is identical to that of diazepam (5 mg/ml); consequently, the large injection volumes in the ferret (3 mg/kg) remain a concern. Dysphoric reactions, such as restlessness, difficult handling, and pacing and vocalization,

TABLE 16-2
 SEDATIVE AND ANESTHETIC CHARACTERISTICS OF VARIOUS INJECTABLE ANESTHETIC COMBINATIONS IN FERRETS

Drug combinations (IM)	Time from injection to lateral recumbency (minutes)	Duration of dorsal recumbency (minutes)	Duration of endotracheal intubation (minutes)	Time from injection to complete mobilization (minutes)
Medetomidine (80 µg/kg)	3 ± 1	>120 ^a	16 ± 14	>120
Medetomidine (80 µg/kg), butorphanol (0.1 mg/kg)	3 ± 1	>120 ^a	91 ± 8 ^a	>120
Medetomidine (80 µg/kg), butorphanol (0.1 mg/kg), ketamine (5 mg/kg)	2 ± 0.5	>180 ^a	95 ± 0 ^a	>180
Xylazine (2 mg/kg)	2 ± 0.9	68 ± 20	35 ± 17	71 ± 19
Xylazine (2 mg/kg), butorphanol (0.2 mg/kg)	2 ± 0.6	82 ± 4	69 ± 5	86 ± 9
Xylazine (2 mg/kg), butorphanol (0.2 mg/kg), ketamine (15 mg/kg)	1 ± 1	94 ± 13	81 ± 19	106 ± 13
Diazepam (3 mg/kg)	3 ± 1	43 ± 8	0	51 ± 12
Diazepam (3 mg/kg), butorphanol (0.2 mg/kg)	3 ± 1	79 ± 11	4 ± 9	85 ± 12
Diazepam (3 mg/kg), butorphanol (0.2 mg/kg), ketamine (15 mg/kg)	4 ± 5	75 ± 34	20 ± 25	95 ± 48
Acepromazine (0.1 mg/kg)	5 ± 3	49 ± 11	0	56 ± 12
Acepromazine (0.1 mg/kg), butorphanol (0.2 mg/kg)	5 ± 1	79 ± 11	16 ± 19	85 ± 12
Acepromazine (0.1 mg/kg), butorphanol (0.2 mg/kg), ketamine (15 mg/kg)	1 ± 0.6	75 ± 34	30 ± 26	95 ± 48

^aIf not reversed with atipamezole. All results modified from references Brown (1997), Canadian Pediatric Society (2000), Marini (1994a), Ko (1998c). Medetomidine in this table can be replaced with 40 µg/kg of dexmedetomidine for the similar effects.

are reported in dogs and cats in association with the use of midazolam (both IV and IM), and preclude its use as a sole agent in healthy dogs and cats (Ilkiw, 1992). Midazolam and diazepam behave similarly in ferrets and neither is recommended for use as the sole compound for sedation in healthy ferrets. The cost of midazolam is higher than that of diazepam.

Unlike acepromazine and diazepam, xylazine and medetomidine are potent sedatives in ferrets. Both xylazine (2 mg/kg) and medetomidine (80 mcg/kg) induce rapid immobilization within 3–5 minutes following IM injection (Ko et al., 1997, 1998a). The quality of the sedation is excellent when compared to the sedation induced by acepromazine or diazepam alone (Ko et al., 1997, 1998a). Xylazine and medetomidine produce profound muscle relaxation adequate for ear cleaning and nail clipping but not for intubation (Ko et al., 1997, 1998a). The duration of immobilization (in dorsal recumbency) induced by xylazine is approximately 40–70 minutes (Ko et al., 1998a). The duration of immobilization after medetomidine, if not reversed, is greater than 150 minutes. The sedation induced by xylazine

and medetomidine is reversed with yohimbine (Sylvina et al., 1990) and atipamezole (Ko et al., 1997), respectively. To reverse xylazine (2 mg/kg, IM), the yohimbine dose is 0.5 mg/kg, IM (Sylvina et al., 1990). To reverse medetomidine (80 µg/kg, IM), the atipamezole dose is the same volume of, or five times the medetomidine dose (400 µg/kg, IM) (Ko et al., 1997).

Acepromazine, diazepam, and midazolam do not have analgesic properties in the ferret (Table 16-1). Ferrets sedated with these sedatives respond to toe and skin pinches with a padded hemostat and tail clamping throughout the period of immobilization (Morrisey et al., 1996). On the other hand, xylazine and medetomidine produce 10–40 minutes of analgesia to padded hemostat toe and skin pinches and tail clamping (Ko et al., 1997, 1998a). It is important when sedating ferrets for painful procedures to consider not only the sedative properties but also the analgesic properties of the sedative agent.

Xylazine and medetomidine have more significant depressive effects on the heart rate and systolic blood pressure than acepromazine and diazepam. The heart rate in ferrets

sedated with acepromazine or diazepam (209–214 beats/min) does not change significantly from baseline or pre-sedation values (224–236 beats/min), while the heart rate following xylazine or medetomidine sedation is significantly decreased (107–127 beats/min) (Ko et al., 1997, 1998a). Systolic blood pressure and respiratory rate both significantly decrease following administration of any of these sedatives (Ko et al., 1997, 1998a); however, all values remain within the acceptable limits (Ko et al., 1998a). In ferrets sedated with these agents and breathing room air, the hemoglobin saturation remains within normal limits (Ko et al., 1998a).

B. Opioids

Opioid agonists, such as morphine, fentanyl, hydromorphone, and buprenorphine, and agonist–antagonists, such as butorphanol, are used for analgesia in preemptive and postoperative analgesia, or in combination with a sedative as a neuroleptic–analgesic in ferrets. The recommended clinical doses of opioids in combination with other sedatives in ferrets are listed in Tables 16-2 and 16-3. Clinically, morphine and hydromorphone can be used for anesthetic premedication in ferrets. The use of opioids as a premedication provides three advantages, sedation, preemptive analgesia, and an anesthetic sparing effect. Morphine (0.25–0.75 mg/kg, SC or IM) or hydromorphone (0.05–0.1 mg/kg, IM or SC) induces mild-to-moderate sedation in healthy ferrets. Fentanyl at 5–10 mcg/kg can be given IV during the surgery to reduce inhalant anesthetic concentrations. The use of anticholinergic agents, such as atropine (0.04 mg/kg, IM) or glycopyrrolate (0.01 mg/kg, IM), is necessary because these doses of opioid agonists induce bradycardia (heart rate less than 70–80 beats/min) in ferrets. Morphine at lower doses (0.025–0.5 mg/kg) induces vomiting in ferrets; the frequency of emesis increases with increasing dosage (Barnes et al., 1991). Hydromorphone is less likely to induce emesis. Morphine and hydromorphone-treated ferrets do not appear profoundly sedated, but often do not resist handling and manipulation. When using morphine and hydromorphone sedation, IV catheterization, bandage changing, or other similar procedures can be performed with minimal resistance. This is a great advantage for postoperative ferrets, because opioids provide not only sedation but also analgesia. Opioid administration also provides an anesthetic-sparing effect. The isoflurane minimal alveolar concentration (MAC) in ferrets is 1.52% (Murat and Housmans, 1988). The concentration of isoflurane used for anesthesia during minimally invasive procedures in ferrets is 2% (Marini et al., 1994b). Morphine (0.25 mg/kg, IV), hydromorphone (0.05 mg/kg, IV), and butorphanol (0.4 mg/kg, IV) all have isoflurane-sparing effects ranging from 10 to 35% (Ko, unpublished data). The isoflurane-sparing effect of butorphanol is less than that with morphine and hydromorphone in ferrets. The sparing effect of opioids may lessen the intraoperative cardiorespiratory depression produced by inhalant anesthetic agents.

Buprenorphine is an opioid partial agonist. It has a slow onset but long duration of action. Following IM administration, the effect of buprenorphine is observed within 30 minutes and lasts approximately 8 hours (Stoelting, 1987). It is postulated that the long duration of action is due to the slow dissociation of buprenorphine from μ receptors (Stoelting, 1987). Buprenorphine is used clinically for pain management in ferrets with a suggested dosage of 0.01 mg–0.03 mg/kg (IV, IM, or SC) every 8–12 hours (Orcutt, 1998). Buprenorphine (0.02 mg/kg, IM) provides good analgesia for up to 6 hours after soft-tissue surgery in ferrets. Higher doses of buprenorphine may not provide any further significant analgesia due to its ceiling effect. The sedation induced by this dose of buprenorphine appears to be mild and the mental status of the ferret can be still monitored with ease. Butorphanol is an opioid agonist–antagonist; its suggested dose is 0.1–0.5 mg/kg, IM or SC (every 2–4 hours) (Brown, 1997; Orcutt, 1998).

C. Neuroleptic Sedative Combinations

When combined with acepromazine or diazepam in healthy ferrets, the analgesic effect of butorphanol (0.2 mg/kg, IM) is unreliable and induces minimal analgesia as assessed by skin and toe pinch and tail clamp (Ko et al., 1997, 1998a, 1998d). In contrast, combining the same dose of butorphanol to xylazine or medetomidine significantly improves the analgesic properties of the neuroleptic–analgesic combination (Table 16-2). When analgesia is desired with an acepromazine–butorphanol or diazepam–butorphanol combination, a butorphanol dose higher than 0.2 mg/kg is recommended. A higher dose of butorphanol (i.e., 0.4 mg/kg) is also recommended for preemptive or postoperative analgesia in ferrets. The analgesic duration is approximately 2–4 hours.

Butorphanol (0.2 mg/kg) does not facilitate the speed of immobilization with acepromazine, diazepam, xylazine, and medetomidine, but it does increase the duration of immobilization by approximately 15–20 minutes (Table 16-1) (Ko et al., 1997, 1998a, 1998d). The xylazine–butorphanol combination provides the most reliable sedation, while the diazepam–butorphanol combination induces the poorest quality of sedation in healthy ferrets (Ko et al., 1998d). Ferrets sedated with these neuroleptic–analgesic combinations cannot be intubated, which emphasizes that neuroleptic–analgesic combinations only induce profound sedation, not general anesthesia (Ko et al., 1998d). However, butorphanol (0.1 mg/kg) combined with medetomidine (80 mcg/kg) does permit intubation in ferrets, and this is attributed to the potency of medetomidine (Ko et al., 1997). The pain and lameness associated with diazepam injection remains a concern when using a diazepam–butorphanol combination in ferrets (Ko et al., 1998d). Combined with the poor quality of sedation, the use of this combination in healthy ferrets is precluded. Midazolam (0.2 mg/kg, IM) and hydromorphone (0.05–0.1 mg/kg, IM) or morphine (0.5–1 mg/kg, IM)

TABLE 16-3
NEUROMUSCULAR BLOCKING AGENTS IN THE FERRET

Agent	Initial dose	Degree of block (%)	Onset ^a	Interval ^a	Duration of action ^a	Infusion regimen
Succinylcholine (reversal by edrophonium) ^c	0.15 mg/kg IV					1 ml/kg/h
Gallamine hydrochloride ^d	3.6 mg/kg					3.6 mg/kg/h
Vecuronium ^c	0.25 mg/kg IV					0.25 mg/kg 1 hour IV
G-1-64 ^f	62 (16) ^b mcg/kg	86 (2.8)	1.6 (0.21)	4.6 (0.60)	10.5 (1.40)	
Mivacurium ^f	12 (1.1)	88 (1.6)	2.7 (0.21)	3.3 (0.40)	10.1 (1.20)	
Atracurium ^f	67 (7.3)	80 (1.8)	1.7 (0.12)	3.4 (0.50)	7.3 (0.50)	
Succinylcholine ^f	150 (20)	91 (5.6)	0.9 (0.07)	1.6 (0.40)	2.7 (0.52)	

^aValues shown are in minutes; the values in parenthesis are SEM.

^bValues shown for all agents below G-1-64 inclusive are means; the values in parenthesis are SEM.

^cMarini and Fox (1998).

^dRoe et al. (1992).

^eYu et al. (2005).

^fGymerek et al. (1999).

appears to induce a more reliable sedation and better analgesia in ferrets (authors' clinical experience). These combinations are well tolerated as a premedication for IV catheterization or face mask induction with an inhalant anesthetic.

As with other opioids, combining butorphanol with a sedative is not without cardiorespiratory side effects. Butorphanol causes a decrease in blood pressure when administered with diazepam, acepromazine, xylazine, and medetomidine (Ko et al., 1997, 1998a, 1998d). When combined with xylazine or medetomidine, the respiratory depressant effect of butorphanol is magnified as evidenced by a decreased respiratory rate and increased exhaled CO₂ concentrations (Ko et al., 1997, 1998d). This respiratory depressive effect is augmented greatly when morphine or hydromorphone is used. Hypotension also develops 70 minutes postinjection with a diazepam–butorphanol combination (Ko et al., 1998d). A similar decrease in blood pressure and respiratory depression occurs with the use of morphine, oxymorphone, or hydromorphone in ferrets (authors' clinical experience).

D. Dissociative Injectable Combinations

Tiletamine, which is chemically similar to ketamine, is more potent and has a longer duration of effect than ketamine. Clinically, tiletamine is proprietarily combined with zolazepam and marketed as Telazol (Lumb and Jones, 1984). Both ketamine and Telazol are used in ferrets. When used alone, ketamine produces several side effects including poor muscle relaxation, rough recoveries, and possible convulsions (Lumb and Jones, 1984). To eliminate these side effects, ketamine is used frequently in combination with diazepam, acepromazine, xylazine, and other injectable anesthetics (Lumb and Jones, 1984). Ketamine (60 mg/kg), xylazine (2 mg/kg)–ketamine (25 mg/kg), and diazepam (3 mg/kg)–ketamine (35 mg/kg)

induced lateral recumbency within 2–3 minutes following IM injection (Moreland and Glaser, 1985). Although both combinations effectively immobilize the ferret, incomplete analgesia occurs with the diazepam–ketamine combination (Moreland and Glaser, 1985). Ketamine and diazepam–ketamine elevate heart rate, exceeding baseline values, while heart rate decreases following administration of the xylazine–ketamine combination (Moreland and Glaser, 1985). Ventricular premature contractions (VPC) can be seen when using any of the three combinations but are more frequently seen with the xylazine–ketamine combination (Moreland and Glaser, 1985). The xylazine–ketamine combination induces acceptable muscle relaxation, analgesia with adequate duration of anesthesia, and a smooth recovery. One of the authors routinely uses ketamine (30 mg/kg IM) and xylazine (3 mg/kg IM) for anesthetic induction in young, healthy ferrets. Anesthesia is adequate for endotracheal intubation, endoscopy, and procedures of similar stimulus. However, use of this combination requires close monitoring for cardiac arrhythmias (Moreland and Glaser, 1985) and atropine should be used as a premedicant.

Acepromazine, midazolam, and medetomidine also have been used in combination with ketamine in ferrets. A combination of acepromazine (0.3 mg/kg) and ketamine (30 mg/kg) works well for chemical restraint during blood collection (Evans and Springsteen, 1998). Mixed in a 9:1 volume ratio (ketamine 100 mg/ml; acepromazine 10 mg/ml) and administered at a dose of 1 ml/3–4 kg, the ketamine–acepromazine combination is acceptable for induction and maintenance of light anesthesia (i.e., acepromazine 0.25–0.33 mg/kg and ketamine 22.5–30 mg/kg) (Evans and Springsteen, 1998). Midazolam (0.4 mg/kg) and ketamine (15 mg/kg) induce adequate sedation for IV catheterization and could be used as a premedication protocol (Evans and Springsteen, 1998). Medetomidine (80 mcg/kg) combined with ketamine (5 mg/kg) and administered intramuscularly induces lateral recumbency within

3 minutes with consciousness and mobility completely restored after atipamezole (400 mcg/kg, IM) (Ko et al., 1997). If anesthesia is not reversed with atipamezole, the lateral recumbency persists for up to 3 hours. The medetomidine–ketamine combination is useful as an induction and injectable anesthetic combination, inducing approximately 60 minutes of analgesia, excellent muscle relaxation, and tolerance to endotracheal intubation for approximately 45 minutes following drug administration (Ko et al., 1997). The duration of the analgesic effects of this combination, as assessed by toe and skin pinch and tail clamp, is three times longer than when medetomidine is administered alone (Ko et al., 1997). Similar findings were observed using medetomidine (0.2 mg/kg IM) and ketamine (10 mg/kg IM) in two related species, the European mink (*Mustela lutreola*) and the polecat (*M. putorius*) (Fournier-Chambrillon et al., 2003).

It is not uncommon to use ketamine with neuroleptic–analgesic combinations in ferrets. Ketamine (15 mg/kg, IM), combined with diazepam (3 mg/kg)–butorphanol (0.2 mg/kg), acepromazine (0.1 mg/kg)–butorphanol (0.2 mg/kg), or xylazine (2 mg/kg)–butorphanol (0.2 mg/kg), induces lateral recumbency and analgesia. However, the duration of recumbency is not increased with the addition of ketamine to the neuroleptic–analgesic combinations (Ko et al., 1998c). The duration of analgesia is less than 10 minutes and few ferrets can be intubated when using the diazepam–butorphanol–ketamine and acepromazine–butorphanol–ketamine combinations (Ko et al., 1998c). Limb twitching and body movements are also common with these combinations, which is inadequate when complete immobilization is required (Ko et al., 1998c). In contrast, the xylazine–butorphanol–ketamine combination provides approximately 60–80 minutes of analgesia with complete immobilization and 60-minute duration of intubation tolerance (Ko et al., 1998c).

Cardiac arrhythmias, such as a profound respiratory sinus arrhythmia and second-degree AV heart block, are commonly seen with all three ketamine combinations (Payton and Pick, 1989). VPC and ventricular bigeminy are observed in ferrets treated with the xylazine–butorphanol–ketamine combination. Hypotension has not been reported; however, respiratory depression is a common side effect of all three ketamine combinations, and hypoxemia has been seen in xylazine–butorphanol–ketamine treated ferrets (Payton and Pick, 1989). Oxygen insufflation, atropine premedication, and close monitoring for arrhythmias is strongly recommended when using ketamine neuroleptic–analgesic combinations in ferrets (Payton and Pick, 1989).

The use of Telazol and its combinations are reported extensively. Telazol has the advantage of a rapid induction of immobilization with a small injection volume (Mason, 1997). At concentrations of 12 and 22 mg/kg IM, Telazol provides excellent immobilization, though muscle relaxation and analgesia is inconsistent when using the lower dose (Payton and Pick, 1989). Telazol (3 mg/kg) combined with ketamine (2.4 mg/kg)

and xylazine (0.6 mg/kg) rapidly induces lateral recumbency and allows intubation (Ko et al., 1996). When glycopyrrolate (0.01 mg/kg) is co-administered with this combination, it decreases salivation and prevents bradycardia. However, profuse salivation with frequent sneezing is common when Telazol (22 mg/kg) is administered alone despite coadministration of glycopyrrolate (Ko et al., 1996). Due to a prolonged, rough recovery associated with opisthotonus, paddling, and swimming motions, the use of high doses of Telazol is not recommended as a sole agent of injectable anesthesia in the ferret (Ko et al., 1996). In addition, the occurrence of hypoxemia during the anesthesia period is not uncommon when using Telazol alone or in combination; therefore, oxygen insufflation is recommended (Ko et al., 1996).

E. Neuromuscular Blocking Agents

Neuromuscular blocking agents are occasionally required in ferrets, especially in the context of prolonged nonsurvival studies, e.g., in neurophysiologic experimentation. The depolarizing agent, succinylcholine, apparently behaves as a nondepolarizing agent in the ferret (Tsai et al., 1990). Dosages for the agents, gallamine, vecuronium, and alcuronium (Table 16-4) have apparently been derived empirically and may not be ideal for clinical procedures from which animals are expected to recover. Neuromuscular blocking agents present special challenges to investigators, in that attention to depth of anesthesia is critical. Guidelines promulgated by the National Institute of Health (National Institutes of Health, 1991) and the National Research Council (National Research Council of National Academy of Sciences, 2003) should be used by investigators and Institutional Animal Care and Use Committees (IACUCs) in developing monitoring regimens for ferrets in which paralytics are used.

V. ANESTHETIC INDUCTION AND MAINTENANCE

A. Injectable Anesthesia

The Telazol–ketamine–xylazine and xylazine (2 mg/kg)–ketamine (25 mg/kg) combinations are preferred because of their smooth induction and recovery, good muscle relaxation, and consistent analgesia (Ko et al., 1998b). In an attempt to improve the duration of intubation tolerance and analgesia and shorten the rough recovery, Telazol can be combined with xylazine and butorphanol. A high dose of Telazol (3 mg/kg) with xylazine (3 mg/kg) and the Telazol (1.5 mg/kg)–xylazine (1.5 mg/kg)–butorphanol (0.2 mg/kg) combination both have a small injection volume (0.02–0.05 ml for a 1–1.5 kg ferret), rapid smooth induction and immobilization (within 2 minutes of injection), with a longer duration of endotracheal intubation

TABLE 16-4
TELAZOL AND ITS COMBINATIONS IN FERRETS

Drugs (all IM)	Injection to lateral recumbency	Duration of dorsal recumbency	Analgesic duration	Intubation duration	Injection to complete mobilization	Comments
Telazol (22 mg/kg)	1.4 ± 0.4	70. ± 27	T 17 ± 14 S 17 ± 11 TL 16 ± 13	15 ± 15	188 ± 42	Rough recovery, VPC were noted
Telazol (3 mg/kg)	1.3 ± 0.2	62 ± 15	T 33 ± 11	43 ± 6	101 ± 10	Hypoxemia—oxygen supplementation needed
Ketamine (2.4 mg/kg) Xylazine (0.6 mg/kg)			S 30 ± 10 TL 34 ± 12			
Telazol (1.5 mg/kg) Xylazine (1.5 mg/kg)	1.7 ± 0.7	72 ± 12	T 14 ± 14 S 5 ± 6 TL 17 ± 15	5 ± 10	74 ± 13	Chemical restraint only
Telazol (3 mg/kg) Xylazine (3 mg/kg)	1.5 ± 0.9	103 ± 13	T 38 ± 27 S 30 ± 12 TL 41 ± 26	26 ± 29	117 ± 20	
Telazol (1.5 mg/kg)	1.3 ± 0.4	114 ± 23	T 100 ± 12	84 ± 21	115 ± 23	Hypoxemia—100% oxygen supplementation needed
Xylazine (1.5 mg/kg) Butorphanol (0.2 mg/kg)			S 68 ± 13 TL 90 ± 17			

Note: T, toe pinch; S, skin pinch; TL, tail clamp. All results modified from references Lichtenberger(2006), Lumb and Jones (1984).

tolerance and analgesia (Table 16-4). However, cardiorespiratory depression is profound when using the Telazol–xylazine–butorphanol combination (Ko et al., 1998b). As with other Telazol combinations, oxygen insufflation is recommended for hypoxemia (Ko et al., 1998b).

An injectable combination of Telazol, medetomidine (or dexmedetomidine), and butorphanol has been recently developed. The Telazol powder is diluted with 2.5 ml of medetomidine (1 mg/ml) or dexmedetomidine (0.5 mg/ml) and 2.5 ml of butorphanol (10 mg/ml) to form a final volume of 5 ml in the Telazol bottle. This is administered at a dose of 0.03 ml/kg, IM and appears to be an economical, effective, and relatively safe combination for ferrets (Ko, unpublished data).

Another total injectable combination is medetomidine (80 mcg/kg, IM), ketamine (5 mg/kg, IM), and butorphanol (0.2 mg /kg, IM) combination. This combination provides a surgical plane of anesthesia for 60–80 minutes with intubation tolerance.

Propofol can be used in ferrets, but there are several disadvantages. Propofol must be administered intravenously. The thick skin of the ferret makes IV drug administration difficult; therefore, it is best to premedicate the ferret with a sedative prior to induction. Some practitioners use propofol for intraosseous injection through a catheter in a long bone of the ferret. The advantages of propofol include rapid induction of unconsciousness, with less tissue irritation than thiopental if perivascular injection does occur. An induction dose of propofol (6–8 mg/kg) without premedication rapidly induces unconsciousness with a relaxed jaw tone, greatly facilitating endotracheal intubation.

With premedicants such as acepromazine, diazepam, xylazine, medetomidine, dexmedetomidine or dexmedetomidine reduce the induction dose of propofol to 1–3 mg/kg. Propofol depresses myocardial contractility in ferrets (Cook and Housmans, 1994). The negative inotropic effect of propofol results from a decrease in intracellular Ca^{++} availability consequent to inhibition of the transsarcolemmal Ca^{++} influx (Cook and Housmans, 1994). IV propofol administration in clinically healthy ferrets rapidly induces oxygen desaturation. As in dogs and cats, respiratory depression, as well as apnea, may also occur following rapid propofol administration. Ferrets should be intubated quickly and provided with immediate oxygen supplementation when propofol is used.

B. Inhalant Anesthesia

The advantages of inhalant anesthesia over injectable anesthesia in ferrets are as follows: (1) a higher concentration of oxygen is provided with the inhalant anesthetic (provided nitrous oxide is not used), (2) the depth of anesthesia is easily adjusted, and (3) recovery times are generally shorter. Since a very high percentage of isoflurane (99%) and sevoflurane (97%) is eliminated via respiration, recovery from inhalant anesthetics is almost completely independent of liver or kidney metabolism. This and other features of inhalant anesthesia make their use in the critically ill ferret especially advantageous (Orcutt, 1998). The disadvantages of inhalant anesthesia include cost, the bulky machine and equipment required, and pollution of the operating

room when intubation is not achieved and only a face mask is used for anesthetic maintenance.

Isoflurane and sevoflurane can be used in ferrets; halothane is no longer available commercially. The blood–gas solubility of isoflurane and sevoflurane at 37°C is 1.46 and 0.68, respectively (Paddleford, 1999). The small solubility of sevoflurane accounts for the rapid induction and recovery times. Isoflurane has been the most commonly used inhalant anesthetic in ferrets. Ferrets can be induced with a chamber similar to that used for cats. Alternatively, ferrets can be wrapped with towels to expose only the head for face mask induction. In healthy ferrets, premedication with a sedative calms the ferret and facilitates face mask induction. Sevoflurane is nonpungent and is potentially an ideal agent for face mask induction (Paddleford, 1999).

Profuse salivation may be associated with isoflurane chamber or face mask induction in ferrets. This may obscure the view of the laryngeal opening and complicate endotracheal intubation. The use of atropine (0.04 mg/kg, IM) or glycopyrrolate (0.01 mg/kg, IM) may reduce salivation. This method of induction induces profound struggling and excitement in the ferret due to large volume barrier and slow buildup of inhalant anesthetic concentration within the induction chamber. Furthermore, chamber induction takes longer, uses more inhalant anesthetic, and generates more pollution when the chamber is opened. Chamber induction is therefore not recommended for use in ferrets. For face mask induction, a small mask covers just the nose and mouth of the ferret or alternatively, the entire head is placed inside the mask for induction. The anesthetic machine is connected to a nonbreathing circuit (e.g., a Bain or modified Jackson Rees). During face mask induction, oxygen flow is set to 1 L/min with 5% isoflurane or 8% sevoflurane. A towel gently wrapped around the ferret minimizes struggling during induction. The eyelid aperture and muscle tone of the ferret will determine when induction has occurred (Imai et al., 1999). In a nonpremedicated ferret, face mask induction achieves a plane of anesthesia suitable for endotracheal intubation in approximately 3–4 minutes. Premedication with a sedative or sedative combination shortens this time.

The published MAC of isoflurane at 37°C is 1.52 (Murat and Housmans, 1988). A surgical plane of anesthesia in ferrets requires 1.3–1.5 times the MAC of isoflurane (1.97–2.28%). The MAC of sevoflurane in the ferret has not been well documented. For skin growth removal, the requirement of sevoflurane in ferrets without premedication ranges from 2.5 to 4.5% (authors' clinical experience). Sevoflurane and isoflurane have been compared in species closely related to the domestic ferret, the Siberian polecat (*M. eversmanni*) and the black-footed ferret (*M. nigripes*) (Gaynor et al., 1997). Sevoflurane produces a more rapid induction and maintains blood pressure better as compared to isoflurane. Sevoflurane should be an appropriate anesthetic for black-footed ferrets (Gaynor et al., 1997). Sevoflurane provides a dose-dependent decrease in arterial blood pressure, left ventricular pressure, systemic vascular resistance, aortic flow,

and dp/dt (an index of contractility) as the expired concentration of sevoflurane increases (MacPhail et al., 2004). Heart rate, central venous pressure, coronary vascular resistance, myocardial oxygen extraction ratio, and τ (the time constant of relaxation) remain unchanged. Cardiac external work decreases, as does myocardial oxygen consumption, causing increased cardiac efficiency at higher concentrations of sevoflurane. These findings indicate that sevoflurane is a safe inhalant anesthetic in ferrets for clinical and research settings (MacPhail et al., 2004). Isoflurane decreases hematocrit, hemoglobin concentration, and red blood cell counts by 30–38% and plasma protein 20–26% from preanesthetic baseline values in ferrets (Marini et al., 1994a, 1994b, 1997). Changes in plasma volume and splenic sequestration of red blood cells induced by hypotension secondary to these inhalant anesthetics are possible mechanisms (Marini et al., 1994a, 1997). Isoflurane anesthesia in ferrets causes splenic sequestration of RBCs which is partially reversed by phenylephrine infusion or termination of anesthesia. Anesthetists should be prepared to administer fluids and/or blood transfusions for isoflurane-anesthetized anemic, geriatric, or debilitated ferrets (Lichtenberger, 2006). Sevoflurane may also cause these hematologic index changes in the ferret, as clinical experience indicates that it decreases red and white blood cell counts, hematocrit, hemoglobin concentration, and plasma protein from preanesthetic baseline values. Further studies to elucidate the hematological changes from sevoflurane in the ferret are needed.

1. Nonbreathing Circuits

Inhalant anesthesia is maintained using a Bain or a modified Jackson Rees nonbreathing circuit. The total oxygen flow rate at induction is 1 L/min and reduced to 300–500 ml/min to minimize the heat loss from the airway. A 200–250 ml/kg oxygen flow rate is considered adequate to eliminate CO₂ in spontaneously ventilated small animals. Since most vaporizers require a minimum oxygen flow rate of 350 ml/min to deliver an accurate anesthetic concentration, a flow rate of 200 ml/kg in a 1 kg ferret may be too low for certain vaporizers. Use of higher flow rates ensures nonbreathing but does so at the expense of excessive use of inhalant agent and carrier gas (Marini et al., 1994a).

2. Ventilators

There are several commercial ventilators (Matrix Hallowell, Model 300 Anesthetic ventilator or Surgivet model SAV 2500) with an interchangeable bellow adapted to animals from ferrets to dogs and cats. It is capable of delivering a tidal volume from 0 to 300 ml. The tidal volume of ferrets is similar to that of cats and can be estimated as 10–15 ml/kg. This ventilator may be used with this tidal volume, a respiratory rate of 8–10 breaths/min, and a peak inspiratory pressure not exceeding 10–15 cm of water (Marini et al., 1997). Capnography readings of end-tidal CO₂ (ETCO₂) or partial pressure of CO₂ in the arterial blood can be

used to titrate the minute volume (respiratory rate/min \times tidal volume) of the ferret by either adjusting the respiratory rate, tidal volume, or both to achieve an ETCO_2 between 35 and 45 mmHg. Other ventilators capable of delivering small tidal volumes may also be used (Lichtenberger, 2006).

VI. MONITORING TECHNIQUES

The circulation (cardiovascular function), oxygenation (respiratory function), ventilation (cardiorespiratory function), body temperature, and depth of anesthesia of the sedated or anesthetized ferret must be monitored closely. Use of a stethoscope, esophageal stethoscope, or other audible heart monitor aids in assessing the "presence," "absence," "regularity," or "irregularity" of the heart beat. Alternatively, digital palpation of a peripheral pulse provides a subjective feeling of "presence" or "absence"; "strong" or "weak"; "regular" or "irregular." Assessing capillary refill time of the ferret provides a subjective assessment of tissue perfusion; a capillary refill time longer than 3 seconds suggests poor tissue perfusion. Electrocardiography (ECG) is a continuous and accurate assessment of cardiac arrhythmia. A lead II ECG can be applied with an ECG adhesive pad on the right and left forepaws and the left rear paw. Alternatively, an ECG clip on the skin of the fore and rear limbs also works. Base-apex leads with the right arm (RA) and left leg (LL) leads placed next to each other on the right side of the neck region and the left arm (LA) lead placed on the left side of the thorax caudal to the heart is another alternative. Lead I or lead III should be selected on the ECG monitor for a clear reading of the ECG wave form. Arterial blood pressure provides information regarding blood flow to the tissues. Arterial blood pressure may be monitored using noninvasive methods such as a Doppler ultrasound probe coupled with a pressure cuff and sphygmomanometer or an automated oscillometric device. The advantage of automated oscillometric device (e.g., Cardell blood pressure monitor, Sharn Veterinary Inc. Tampa, FL) over Doppler ultrasonic device is that the oscillometric is automated and requires neither experience nor labor of the operator. The blood pressure cuff can be placed on the assessable limb or placed at the base of the tail with the hair clipped. An infant size cuff (size one) can be used. The Doppler ultrasound probe can be placed at the ventral aspect of the paw, or at the base of the ventral aspect of the tail to get a good signal.

If mean arterial blood pressure is below 60 mmHg, organ and tissue perfusion is inadequate in an anesthetized ferret. Normal systolic blood pressure for an anesthetized ferret is 90–120 mmHg. Diastolic blood pressure ranges from 55 to 90 mmHg.

Objective methods for evaluating a ferret's oxygenation include using blood gas analysis for partial pressure of oxygen in arterial blood (PaO_2), hemoximetry, and pulse oximetry. Pulse oximetry provides a noninvasive, continuous detection

of pulsatile arterial blood in the tissue bed, calculates the percentage of oxyhemoglobin present in the arterial blood, and provides the pulse rate of the monitored ferret. The pulse oximeter probe can be placed on the tongue, the paw, or at the tip of the tail to obtain a reading in the ferret. Pulse oximetry has rapidly become standard care in anesthetized ferrets; however, motion (e.g., shivering), ambient light, poor peripheral blood flow from hypotension or vasoconstriction, electrical noise from electrocautery, increased carboxyhemoglobin and methemoglobin levels, and dark skin color can affect the function of the pulse oximeter. A pulse oximeter reading less than 90% is an indication of hypoxia. Enriched oxygen (100%) should be provided, and respiratory function should be monitored. Artificial ventilation should be provided if respiratory depression occurs.

Subjective evaluation of ventilation efficiency of an anesthetized ferret is performed by observing chest wall movement or reservoir bag excursion when the ferret is connected to an anesthesia machine with a nonbreathing circuit. Auscultation of breathing sounds via an esophageal stethoscope or an audible respiratory monitor determines only respiratory rate and the absence or presence of respiration. Thermistor probes placed on the endotracheal tube adapter are available and give a digital display of respiratory rate.

Objective evaluation and monitoring of ventilation efficiency requires either blood gas analysis or capnometry. Arterial blood gas analysis measures arterial blood pH, bicarbonate, and partial pressures of oxygen and CO_2 . PaCO_2 is an index of ventilation efficiency. A less expensive alternative is capnometry, which measures ETCO_2 and provides a numerical display of CO_2 concentration in the expired air. ETCO_2 is the partial pressure of CO_2 at the end of exhalation and reflects the partial pressure of CO_2 in the alveoli. The measurement of ETCO_2 is useful for determining optimal minute ventilation, hypoventilation, airway disconnection, or airway obstruction. A capnograph presents a graphic display of exhaled CO_2 gas and ETCO_2 concentration and also calculates the respiratory rate of the patient. ETCO_2 concentrations between 35 and 45 mmHg are considered normal in anesthetized ferrets. ETCO_2 higher than 45 mmHg indicates potential ventilation deficiency, while a low ETCO_2 indicates either hyperventilation or a low pulmonary circulation.

Monitoring body temperature in the anesthetized ferret is very important. A temperature probe placed into the esophagus or rectum provides continuous body temperature monitoring. Hypothermia can result in bradycardia, hypotension, prolonged recovery, and ultimately death. Moderate-to-severe hypothermia (body temperature below 95°F or 35°C) requires active warming. Using towels, insulated surgery tables, warm water heating blankets, and active forced hot air warmers are effective for preventing hypothermia. After surgery, a hair dryer on the low warm setting will facilitate body warming.

The depth of anesthesia should be monitored throughout the procedure to verify that the proper plane of anesthesia is maintained. Palpebral reflexes, eyelid aperture, ventral rotation

TABLE 16-5
ANALGESIC DRUG DOSAGES FOR FERRETS

Drug/route	Dose/route	Effects	Duration	Indications
<i>Opioids</i>				
Butorphanol	0.2–0.8 mg/kg, SC, IM or IV	Analgesia/sedation	1–2 hours	For mild-to-moderate degree of pain
Morphine	0.25–1 mg/kg, SC, IM, or IV	Analgesia/sedation; may vomit, bradycardia may occur with doses higher than 0.5 mg/kg	3–4 hours	For mild-to-severe degree of pain
Hydromorphone	0.025–0.1 mg/kg, SC, IM or IV	Analgesia/sedation, occasionally vomit, bradycardia and respiratory depression may occur	1–2 hours	For mild-to-severe degree of pain
Fentanyl	4–10 µg/kg, IM or IV	Analgesia; bradycardia and respiratory depression may occur	30 minute	For immediate relief of severe pain
Buprenorphine	0.01–0.02 mg/kg, SC, IM, IV	Analgesia, slow onset of effect	6–8 hours	
<i>Alpha-2 agonists</i>				
Medetomidine	0.02–0.04 mg/kg, SC, IM or IV	Analgesia—moderate sedation	30–60 minutes	Need sedation with analgesia
Dexmedetomidine	0.01–0.03 mg/kg SC, IM, IV			
Xylazine	1–2 mg/kg	Analgesia—moderate sedation	30–50 minutes	Need sedation with analgesia
<i>NSAID</i>				
Ketoprofen	1–2 mg/kg, SC, IM, IV, PO	Analgesia, anti-inflammation	24 hours	In combination with opioids for severe pain with longer-lasting analgesia effect
Carprofen	2–4 mg/kg, SC, IM, IV, PO	Analgesia, anti-inflammation	24 hours	In combination with opioids for severe pain with longer-lasting analgesia effect
Meloxicam	0.2 mg/kg, SC, IM, IV or PO	Analgesia, anti-inflammation	24 hours	In combination with opioids for severe pain with longer-lasting analgesia effect
<i>Local anesthetic</i>				
Lidocaine	2 mg/kg, local infiltration	Local analgesia	60 minutes	Alleviate pain locally
Bupivacaine	1 mg/kg, local infiltration	Local analgesia	4–6 hours	Alleviate pain locally
Mepivacaine	2 mg/kg, local infiltration	Local analgesia	2–3 hours	Alleviate pain locally

of the eyeballs, reaction to surgical stimulation, and cardiorespiratory variables all indicate the anesthetic depth of the ferret. The depth of anesthesia should be increased if any one of these indicates inadequate anesthesia.

VII. RECOVERY AND PAIN MANAGEMENT

Considerations for recovery in ferrets are similar to those encountered in other animals. Attention to heat, energy, and hydration are critical to successful recovery in this species.

Pain assessment is difficult in ferrets due to the innate ability of ferrets to hide pain. Analgesic agents that work in dogs, cats, and humans are likely effective in ferrets. Preemptive, multimodal pain management techniques using various analgesic agents acting via different pain pathways work well in the ferret. Opioids (butorphanol, buprenorphine, hydromorphone, morphine, and fentanyl), alpha-2 agonists (xylazine, medetomidine), dissociatives (ketamine, tiletamine as part of Telazol), local anesthetics (lidocaine, bupivacaine), and nonsteroidal anti-inflammatory drugs (NSAIDs, carprofen, ketoprofen, meloxicam) are effective analgesic agents for ferrets.

Opioids can be included in the anesthetic premedication to alleviate intraoperative and postoperative pain with repeated dosing. Lidocaine (2 mg/kg) or bupivacaine (1–2 mg/kg) can be diluted with saline and infiltrated at the surgical site prior to and after the surgery to alleviate pain. Using an NSAID as part of the multimodal analgesic agent following surgery will reduce inflammation and pain in the ferret. Ferrets, like cats, are deficient in the glucuronidation pathway (Litchtenberger, 2006) and may metabolize NSAIDs slowly; therefore, ferrets are prone to NSAID toxicity, including renal failure, perforation or ulceration of the gastrointestinal tract, and bleeding. However, one or two doses of NSAID following surgery are likely to improve the quality and duration of analgesia when combined with opioids or other analgesic agents (Table 16-5). The authors like to use carprofen at 4 mg per kg, SC or meloxicam at 0.2 mg/kg, SC for ferrets.

VIII. SPECIAL CONSIDERATIONS

A. Prolonged Anesthesia

Anesthetic regimens for prolonged nonsurvival studies have been modified from those used in other species. Inhalant anesthetics at anesthetic concentrations may dampen responses under study. The use of nitrous oxide in conjunction with isoflurane reduces the requirement for the latter due to the carrier gas effect. It should not be used in excess of 70% of the total gas flow. Disadvantages of nitrous oxide, e.g., cost, abuse potential, failure of absorption by activated charcoal, and diffusion hypoxia in the survival setting, must all be considered when planning to adopt its use in an anesthetic regimen. A combination of injectable agents administered either as constant-rate infusions or as intermittent boluses may be used in the setting of subanesthetic concentrations of inhalants for the purpose of preserving desired physiologic responses. Opioids, dissociatives, propofol, benzodiazepines, and neuromuscular blockers are some of the agents used for this purpose in other species. These techniques must have IACUC-approved provisions for monitoring adequate depth of anesthesia.

Additional agents used for long-term anesthesia in acute studies include urethane and barbiturates (Roe et al., 1992).

B. Neonatal Anesthesia

One method of inducing hypothermia in kits is by wrapping them in moist gauze and placing them in a container of crushed ice until spontaneous movement and respiration have stopped. Forty-five minutes of hypothermia in crushed ice typically yields ten minutes of surgical anesthesia. Maintenance of anesthesia is produced by placing the kit on a bed of crushed ice or an ice-cooled glass plate. The development of frostbite

is precluded by wrapping the kit in gauze or placing it in the finger of a latex glove, covering the surgery plate with surgical drape, minimizing anesthesia time, and avoiding the use of dry ice. Kits should be re-warmed under a heat lamp before return to the jill. Only pluriparous jills that have demonstrated good maternal qualities should be used. Some investigators manipulate only one-half of the litter so that lactation failure in the jill does not occur should surgically manipulated animals fail to nurse robustly.

With regard to the induction of anesthesia, it is likely that the animals experience the same discomfort and response that are experienced by any other animal with similar disruptions to homeostasis. This is transient, however, and the animals are so small and have so much surface area that cooling is not prolonged. Cooling slows nerve transmission and this presumably is the mechanism by which anesthesia eventually occurs. The authors have experienced variable loss rates, but 80–100% survival is not uncommon if the operator is experienced. Monitoring is minimal due to the small size of the neonate and the nature of the anesthetic. Hemorrhage greater than that required to imbue two cotton-tipped applicator swabs with blood impacts negatively on survival. Spontaneous respirations may not recur during the procedure. There is no hemodynamic monitoring, simply the absence of respiration and movement.

With regard to postoperative care, opioids are avoided because they typically have a prolonged duration of effect in neonates and may depress respiration and suckling (Davis, 1991). NSAIDs or local anesthetic techniques with diluted agents could conceivably be used.

The consensus is that neonatal humans have the neurologic maturity to experience pain; certainly they have behaviors that are subjectively aversive to potentially noxious stimuli (Anand et al., 2006; Canadian Pediatric Society, 2000). They also show hemodynamic and humoral responses that are consistently associated with the experience of pain. Ferrets have certain sensory systems, e.g., the visual system that are extremely altricial at birth; research on neonatal pain or the development of the “pain pathways” in this species, to the author’s knowledge, does not exist. The use of analgesic agents may be required by IACUCs as acceptance of the phenomenon of neonatal pain grows, and as practice evolves towards standard administration of these agents to neonates subjected to surgical procedures.

IX. AUTHORS’ PREFERENCES

A. Ko

Telazol–medetomidine (or dexmedetomidine)–butorphanol combination in ferrets:

- (a) 0.02 ml/kg, IM for moderate-to-profound sedation for diagnostic procedures or face mask induction.

- (b) 0.03–0.04 ml/kg, IM for anesthesia induction for endotracheal intubation or for surgical plane of anesthesia for 30–50 minutes.

B. Marini

Ketamine 30 mg/kg IM and xylazine 3 mg/kg IM after atropine premedication (0.04 mg/kg IM) followed by maintenance with isoflurane (to effect) delivered via coaxial circuit and endotracheal tube.

REFERENCES

- Anand, K.J.S., Aranda, J.V., Berde, C.B., and Buckman, S. (2006). Summary proceedings from the neonatal pain-control group. *Pediatrics* **117**, S9–S22.
- Barnes, N.M., Bunce, K.T., Naylor, R.J., and Rudd, J.A. (1991). The actions of fentanyl to inhibit drug-induced emesis. *Neuropharmacology* **30**, 1073–1083.
- Brown, S.A. (1997). Clinical techniques in domestic ferrets. *Semin. Avian Exot. Pet Med.* **6**, 75–78.
- Canadian Pediatric society. (2000). Fetus and newborn committee. Prevention and management of pain and stress in the neonate. *Pediatrics* **105**, 454–461.
- Cook, D.J., and Housmans, P.R. (1994). Mechanism of the negative inotropic effect of propofol in isolated ferret ventricular myocardium. *Anesthesiology* **80**(4), 859–871.
- Davis, P.J. (1991). Pain in the neonate: The effects of anesthesia. *ILAR J.* **33**.
- Evans, A.T., and Springsteen, K.K. (1998). Anesthesia of ferrets. *Semin. Avian Exot. Pet Med.* **7**, 48–52.
- Fournier-Chambrillon, C., Chusseau, J.P., Dupuch, J., Maizeret, C., and Fournier, P. (2003). Immobilization of free-ranging European mink (*Mustela lutreola*) and polecat (*Mustela putorius*) with medetomidine-ketamine and reversal by atipamezole. *J. Wildl. Dis.* **39**, 393–399.
- Gaynor, J.S., Wimsatt, J., Mallinckrodt, C., and Biggins, D. (1997). A comparison of sevoflurane and isoflurane for short-term anesthesia in pole cats (*Mustela eversmanni*). *J. Zoo Wildl. Med.* **28**(3), 274–279.
- Gymerek, L. et al. (1999). Pharmacology of G-1-64, a new nondepolarizing neuromuscular blocking agent with rapid onset and short duration of action. *Acta Anaesthesiol. Scand.* **43**, 651–657.
- Ilkiw, J.E. (1992). Other potentially useful new injectable anesthetic agents. *Vet. Clin. North Am. Small Anim. Pract.* **22**, 281–289.
- Imai, A., Steffey, E.P., Farver, T.B., and Ilkiw, J.E. (1999). Assessment of isoflurane-induced anesthesia in ferrets and rats. *Am. J. Vet. Res.* **60**, 1577–1583.
- Ko, J.C.H., Heaton-Jones, T.G., and Nicklin, C.F. (1997). Evaluation of the sedative and cardiorespiratory effects of medetomidine, medetomidine-butorphanol, medetomidine-ketamine, medetomidine-butorphanol-ketamine in ferrets. *J. Am. Anim. Hosp. Assoc.* **33**, 438–448.
- Ko, J.C.H., Nicklin, C.F., Heaton-Jones, T.G., and Kuo, W.C. (1998a). Comparison of sedative and cardiorespiratory effects of diazepam, acepromazine and xylazine in ferrets. *J. Am. Anim. Hosp. Assoc.* **34**, 234–241.
- Ko, J.C.H., Nicklin, C.F., Montgomery, T., and Kuo, W.C. (1998b). Comparison of anesthetic and cardiorespiratory effects of tiletamine-zolazepam-xylazine and tiletamine-zolazepam-xylazine-butorphanol in ferrets. *J. Am. Anim. Hosp. Assoc.* **34**, 164–174.
- Ko, J.C.H., Pablo, L.S., Bailey, J.E., and Heaton-Jones, T.G. (1996). Anesthetic effects of Telazol and combinations of ketamine-xylazine and Telazol-ketamine-xylazine in ferrets. *Contemp. Top.* **35**, 47–52.
- Ko, J.C.H., Smith, T.A., Kuo, W.C., and Nicklin, C.F. (1998c). Comparison of anesthetic and cardiorespiratory effects of diazepam-butorphanol-ketamine, acepromazine-butorphanol-ketamine, and xylazine-butorphanol-ketamine in ferrets. *J. Am. Anim. Hosp. Assoc.* **34**, 407–416.
- Ko, J.C.H., Villarreal, A., Kuo, W.C., and Nicklin, C.F. (1998d). Evaluation of sedative and cardiorespiratory effects of diazepam-butorphanol, acepromazine-butorphanol, and xylazine-butorphanol in ferrets. *J. Am. Anim. Hosp. Assoc.* **34**, 242–250.
- Lichtenberger, M. (2006). Shock, fluid, therapy, anesthesia and analgesia in the ferret. *Exot. DVM* **7**(2), 24–30.
- Lumb, W.V., and Jones, E.W. (1984). Other methods for producing general anesthesia. In “Veterinary Anesthesia.” (W.V. Lumb and E.W. Jones, eds.), 2nd ed., pp 307–331. Lea & Febiger, Philadelphia, PA.
- MacPhail, C.M., Monnet, E., Gaynor, J.S., and Perini, A. (2004). Effect of sevoflurane on hemodynamic and cardiac energetic parameters in ferrets. *Am. J. Vet. Res.* **65**(5), 653–658.
- Marini, R.P., Callahan, R.J., Jackson, L.R., Jyawook, S., Esteves, M.I., Fox, J.G., Wilkinson, R.A., and Strauss, H.W. (1997). Distribution of technetium 99 m labeled red blood cells during isoflurane anesthesia in ferrets. *Am. J. Vet. Res.* **58**(7), 781–785.
- Marini, R.P., Esteves, M.I., and Fox, J.G. (1994a). A technique for catheterization of the urinary bladder in the ferret. *Lab. Anim.* **28**, 155–157.
- Marini, R.P., and Fox, J.G. (1998). Anesthesia, surgery and biotechnology. Chapter 19 In “Biology and Diseases of the Ferret.” (J.G. Fox, ed.), 2nd ed., pp 449–484. Williams and Wilkins.
- Marini, R.P., Jackson, L.R., Esteves, M.I., Andrutis, K.A., Goslant, C.M., and Fox, J.G. (1994b). Effect of isoflurane on hematologic variables in ferrets. *Am. J. Vet. Res.* **55**(10), 1479–1483.
- Mason, D.E. (1997). Anesthesia analgesia, and sedation for small mammals. In “Ferrets, rabbits, and Rodents: Clinical medicine and Surgery.” (E.V. Hillyer and K.E. Quesenberry, eds.), pp 378–391. WB Saunders, Philadelphia, PA.
- Moreland, A.F., and Glaser, C. (1985). Evaluation of ketamine, ketamine-xylazine, and ketamine-diazepam anesthesia in the ferret. *Lab. Anim. Sci.* **35**, 287–290.
- Morrissey, J.K., Carpenter, J.W., and Kolmstetter, C.M. (1996). Restraint and diagnostic techniques for ferrets. *Vet. Med.* **91**(12), 1084–1097.
- Muir, W.W., and Birchard, S.J. (1997). Questions and answers on analgesia, anesthesia, and sedation. Proceedings of a Symposium. The North American Veterinary Conference, Orlando, FL, pp 9.
- Murat, I., and Housmans, P.R. (1988). Minimal alveolar concentration of halothane, enflurane, and isoflurane in ferrets. *Anesthesiology* **68**(5), 783–786.
- National Institutes of Health. (1991). Preparation and Maintenance of Higher Mammals During Neuroscience Experiments: Report of a National Institutes of Health Workshop; NIH pub no. 91-3207. U.S. Department of Health and Human Services.
- National Research Council of National Academy of Sciences. (2003). Guidelines for the Care and Use of Mammals in Neuroscience and Behavioral Research, 2003.
- Orcutt, C.J. (1998). Emergency and critical care of ferrets. *Vet. Clin. North Am. Exot. Anim. Pract.* **1**(1), 99–126.
- Paddleford, R.R. (1999). Anesthetic agents. In “Manual of Small Animal Anesthesia.” (P.R. Paddleford, ed.), 2nd ed., pp 31–77. W.B. Saunders Company, New York.
- Payton, A.J., and Pick, J.R. (1989). Evaluation of a combination of tiletamine and zolazepam as an anesthetic for ferrets. *Lab. Anim. Sci.* **39**, 243–246.
- Roe, A.W., et al. (1992). Visual projections routed to the auditory pathway in ferrets: Receptive fields of visual neurons in primary auditory cortex. *J. Neurosci.* **12**(9), 3651–3664.
- Stoelting, R.K. (1987). Opioid agonists and antagonists. In “Pharmacology and physiology in anesthetic practice.” (R.K. Stoelting and J.B. Lippincott, eds.), pp 69–133. Philadelphia, PA.
- Sylvina, T.J., Berman, N.G., and Fox, J.G. (1990). Effects of yohimbine on bradycardia and duration of recumbency in ketamine/xylazine-anesthetized ferrets. *Lab. Anim. Sci.* **40**, 178–182.

- Tsai, S.K., Gyermek, I., and Lee, C. (1990). Neuromuscular pharmacology of succinylcholine in the ferret. *Anesthesiology* **73**, A873.
- Yu, H., Farley, B.J., Jin, D.Z., and Sur, M. (2005). The coordinated mapping of visual space and response features in visual cortex. *Neuron* **47**, 267–280.

ADDITIONAL READING

- Branson, K.R., Ko, J.C.H., Tranquilli, W.J., Benson, G.J., and Thrumon, J.C. (1993). Duration of analgesia induced by epidurally administered morphine and medetomidine in dogs. *J. Vet. Phar. Ther.* **16**, 369–372.
- Flecknell, P.A. (1998). Analgesia in small mammals. *Semin. Avian Exot. Pet Med.* **7**, 41–47.
- Muir, W.W. III, and Hubbell, J.A.E. (1998). Drugs used for preanesthetic medication. In “Handbook of Veterinary Anesthesia,” pp 15–28. The C.V. Mosby Company, St. Louis, MO.
- Reid, J., and Nolan, A.M. (1999). Intravenous anaesthetics. In “Manual of Small Animal Anaesthesia and Analgesia.” (S. Seymour, and R. Gleed, eds.), pp 87–97. British Small Animal Veterinary Association.
- Unnerstall, J.R., Kopajtic, T.A., and Kuhar, M.J. (1984). Distribution of alpha-2 agonist binding sites in the rat and human central nervous system: Analyses of some functional, anatomic correlates of the pharmacologic effects of clonidine and related adrenergic agents. *Brain Res. Rev.* **7**, 69–101.

Chapter 17

Anesthesia and Analgesia in Other Mammals

Jeff Wyatt

I. Marsupialia: Marsupials	458
A. Family Didelphidae	458
B. Family Phalangeridae	458
C. Family Potoroidae	459
D. Family Petauridae	459
E. Manual Restraint	459
F. Chemical Restraint	459
G. Vascular Access	459
H. Fluid Therapy	459
II. Scandentia and Insectivora: Insectivores	459
A. Family Tupaiidae	460
B. Family Soricidae	460
C. Manual Restraint	461
D. Chemical Restraint	462
E. Blood Collection	462
III. Rodentia: Nontraditional Species of Laboratory Rodents	462
A. Suborder Castorimorpha	463
B. Suborder Myomorpha	463
C. Manual Restraint	466
D. Chemical Restraint	466
E. Intraoperative Management	466
F. Recovery	467
G. Suborder Sciuromorpha	467
H. Suborder Hystricomorpha—Chinchillas, Guinea Pigs, Degus	468
IV. Lagamorpha: Pikas, Hares	470
A. Family Leporidae	471
B. Family Ochotonidae	471
V. Xenarthra: Edentates (Armadillos)	471
A. Nine-Banded Armadillo— <i>Dasypos novemcinctus</i>	471
VI. Chiroptera: Bats	472
A. Manual Restraint	473
B. Chemical Restraint	473
C. Recovery	473
D. Blood Collection	473
VII. Carnivora: Bears, Hyena	473
A. Grizzly or Brown Bear— <i>Ursus arctos</i>	473
B. Spotted Hyena— <i>Crocuta crocuta</i>	474
VIII. Prosimii: Gray Mouse Lemur	475
A. Gray Mouse Lemur— <i>Microcebus murinus</i>	475
References	475

The discipline of comparative medicine contributes to a greater understanding of life through studies defining and comparing organisms and processes. Animals other than traditional laboratory species offer unique anatomical, physiological, and developmental characteristics making them valuable models for the study of human disease and disorders. Nontraditional species of laboratory mammals useful in biomedical research are described with attention to principles of anesthesia and analgesia.

I. MARSUPIALIA: MARSUPIALS

Marsupials have short gestations, undeveloped neonates, extended development and lactation in the pouch, metabolic rates 26–35% lower than those of equivalently sized eutherian mammals, and lower core body temperatures, making them uniquely interesting for biomedical research applications (Holz, 2003; Pye, 2001). The marsupials most commonly used in biomedical research are found in four families including relatively small species compared to the more familiar macropod kangaroos and wallabies found in zoos.

Order Marsupialia

Family Didelphidae (New World opossums)

Didelphis virginiana (Virginia opossum)

Monodelphis domestica (short-tailed opossum)

Family Phalangeridae (Australian opossums)

Trichosurus vulpecula (brush-tail opossum)

Family Potoroidae

Potorous tridactylus (long-nosed potoroo)

Bettongia gaimardi (Tasmanian bettong)

Family Petauridae

Petaurus breviceps (sugar glider)

A. Family Didelphidae

1. Virginia Opossum—*Didelphis virginiana*

The Virginia opossum, North America's only marsupial, is nocturnal and weighs 3.7–6.4 kg (Fig. 17-1). They play dead or "possum" when threatened by a predator. Their gestation is of 13 days with a 95–105-day pouch life (Newell and Berg, 2003). The Virginia opossum is used for studies of gastric banding (O'Rourke et al., 2006), parasitism (DeStefani et al., 2006; Dubey et al., 2000), infectious disease (Fitzgerald et al., 2003), metabolism (Weber and O'Connor, 2000), snake venom toxicity (Neves-Ferreira et al., 2000), neuron regeneration (Wang et al., 1999), and toxicology (Liapis et al., 1997).

2. Short-tailed Opossum—*Monodelphis domestica*

The short-tailed opossum is a small marsupial (90–155 g) found throughout the forests of Brazil, Bolivia, Argentina, and Paraguay. Their gestation is of 14–15 days with postpartum



Fig. 17-1 Virginia opossum—*Didelphis virginiana*.
Photo credit: American Society of Mammalogists, Mammal Images Library.



Fig. 17-2 Brush-tail opossum—*Trichosurus vulpecula*.
Photo credit: American Society of Mammalogists, Mammal Images Library.

attachment to nipples for 3–4 weeks (Moore and Myers, 2006). The short-tailed opossum has a rudimentary flap of abdominal skin instead of a pouch (Johnson-Delaney, 2006). The short-tailed opossum is used in studies of exercise metabolism (Schaeffer et al., 2005), developmental anatomy and physiology (Kraus and Fadem, 1987; Robinson and Van de Berg, 1994; Stolp et al., 2005), ultraviolet radiation-induced melanoma (Robinson and Van de Berg, 1994), and cytogenetics (Kraus and Fadem, 1987). There is no orbital sinus for blood collection (Kraus and Fadem, 1987).

B. Family Phalangeridae

1. Brush-tail Opossum—*Trichosurus vulpecula*

The brush-tail opossum weighing 1.2–4.5 kg is an arboreal, nocturnal marsupial found commonly throughout Australia and Tasmania and is considered an agricultural pest (Fig. 17-2). Their gestation is of 18 days with a 16-week pouch life (Meyer, 2000). The brush-tail opossum is used for studying oxytocin and vasopressor neurohypophyseal peptides (Bathgate et al., 1992).

C. Family Potoroidae

1. *Long-nosed Potoroo—Potorous tridactylus*

The potoroo is a rabbit-sized marsupial common to Australia and Tasmania weighing up to 1.8 kg with a 38-day gestation and 130-day pouch life (Landesman, 1999). They are used for studies of nonshivering thermogenesis (Nicol, 1978), metabolism (Umminger, 1975), parotid salivary gland function (Beal, 1992), respiratory physiology (Baudinette et al., 1993; Nicol et al., 1977; Ryan et al., 1983), and sperm anatomy and motility and reproductive toxicology (Bryant and Rose, 1985).

2. *Tasmanian Bettong or Rat Kangaroo—Bettongia gaimardi*

The Tasmanian bettong is a 1.2–2.3-kg nocturnal marsupial, extinct in Australia after introduction of the red fox but fairly common in Tasmania. Their gestation is of 21 days and pouch life of 14 weeks (Lundrigan and Gallego, 2005). They are used for studying thyroid function (Rose and Kuswanti, 2004), nonshivering thermogenesis (Rose et al., 1999), reproductive endocrinology (Rose and MacFayden, 1997), and muscle physiology (Ye et al., 1995).

D. Family Petauridae

1. *Sugar Glider—Petaurus breviceps*

The sugar glider is a small (80–140 g) Australian, arboreal marsupial gaining popularity in the U.S. pet trade. They have a gliding membrane extending between the fore and hind limbs. They become torpid at cool temperature extremes. The gestation is of 16 days with a 70-day pouch life (Passata, 1999). They are used for studies of thermoenergetics (Holloway and Geiser, 2001a, 2001b), aerobic metabolism (Holloway and Geiser, 2001a, 2001b), depression (Jones et al., 1995), metabolism (Bradley and Stoddardt, 1990), angiography (Buttery et al., 1990), gliding physiology (Endo et al., 1998), and transthyretin expression (Duan et al., 1995).

E. Manual Restraint

The small marsupials used in biomedical research may be firmly gripped behind the head and the tail base or hind legs for placement in an anesthetic induction chamber or administration of intramuscular injections (Holz, 2003; Pye, 2001; Wallach and Boever, 1983). Sugar gliders may be restrained in a bag with head exposed for mask induction with isoflurane or leg exposed for IM injection (Pye, 2001).

F. Chemical Restraint

Isoflurane is the agent of choice for both induction via mask (3–5%) or chamber as well as maintenance (1–3%) for adults

and neonates (Carpenter, 2005; Hernandez-Divers, 2004; Holz, 2003; Pye, 2001; Shima, 1999; Wallach and Boever, 1983) and is the technique recommended by the author. Premedication of sugar gliders with butorphanol (0.2 mg/kg IM) contributes to a smooth induction when using a chamber or face mask for delivery of isoflurane (Hernandez-Divers, 2004). Enflurane and sevoflurane may be used to effect (Carpenter, 2005). Preanesthetic fasting of 4–6 hours is recommended, since regurgitation under anesthesia is possible (Holz, 2003). Other injectables provide adequate anesthesia for minor procedures or endotracheal intubation (Table 17-1). Premedication with atropine 0.02–0.05 mg/kg IM, IV, SQ (Carpenter, 2005; Holz, 2003) or glycopyrrolate 0.01–0.02 mg/kg IM, IV, SQ (Carpenter, 2005; Shima, 1999) can aid in control of hypersalivation (Tables 17-2 and 17-3).

G. Vascular Access

The jugular, femoral, lateral coccygeal, and cephalic veins are accessible for blood collection or catheterization (Holz, 2003; Wallach and Boever, 1983). The ventral tail vein of the Virginia opossum may be used for blood collection as well as catheterization (Johnson-Delaney, 2006; Wallach and Boever, 1983).

H. Fluid Therapy

For marsupials used in research, 50–100 ml/kg/day of crystalloid fluids may be administered subcutaneously using a butterfly catheter (Johnson-Delaney, 2006). A femoral intraosseous catheter may be used for fluid replacement in sugar gliders, short-tailed opossums, and Virginia opossums by first anesthetizing the animal and aseptically preparing the hip area as if for surgery. After an optional local skin block (2% lidocaine), a 1 in., 18–22-gauge hypodermic or spinal needle is placed into the proximal aspect of the femur through a small skin incision. After taping the needle in place, administer warmed fluids at 5 ml/h. Avoid fluids with glucose since marsupials develop cataracts and hepatic lipidosis with dextrose-containing fluids (Johnson-Delaney, 2006).

II. SCANDENTIA AND INSECTIVORA: INSECTIVORES

Insectivores used in biomedical research include shrews (*Sorex* sp, *Cryptotis* sp, *Suncus* sp, *Tupaia* sp) and hedgehogs all with rapid heart rates (up to 800 beats/min for shrews), high metabolic rates, rod-prominent retinas, small brains with few fissures, low body temperatures 91–95°F (33–35°C), and seasonal torpor or hibernation at temperatures less than 65°F (18°C) (Barbiers, 2003; Fine et al., 1986; Wallach and Boever, 1983).

Order Scandentia
Family Tupaiidae

TABLE 17-1
INJECTABLE ANESTHETICS FOR MARSUPIALS

Species	Drug dosage and route	References
All opossums ^a	Ketamine 20 mg/kg IM plus xylazine 10 mg/kg IM Tiletamine/zolazepam 5–10 mg/kg IM Tiletamine/zolazepam 1–3 mg/kg IV	Holz, 2003 Holz, 2003; Pye, 2001; Wallach and Boever, 1983 Pye, 2001
Short-tailed opossum	Ketamine 40 mg/kg IM hind limb	Robinson and Van de Berg, 1994
Potoroos	Ketamine 30 mg/kg IM plus xylazine 6 mg/kg IM Tiletamine/zolazepam 3.3–19.1 mg/kg IM Tiletamine/zolazepam 14.7 mg/kg IM Ketamine 30 mg/kg IM (1 hour duration)	Holz, 2003 Pye, 2001 Schobert, 1987 Pye, 2001
Bettong	Pentobarbital 60 mg/kg IP for terminal perfusion	Ye et al., 1995
Sugar gliders ^b	Ketamine 30 mg/kg IM plus xylazine 6 mg/kg IM Ketamine 20 mg/kg IM followed with isoflurane Tiletamine/zolazepam causes neurologic syndromes and death at 10 mg/kg	Holz, 2003 Carpenter, 2005; Pye, 2001 Carpenter, 2005; Pye, 2001
Virginia opossum	Tiletamine/zolazepam 10–20 mg/kg IM supplemented with ketamine 10–25 mg/kg IM or 5–10 mg/kg IV (do not supplement with tiletamine/ zolazepam due to prolonged recovery)	Shima, 1999
Brushtail opossum	Ketamine 50 mg/kg IM plus xylazine 10 mg/kg IM Tiletamine/zolazepam 10 mg/kg IM Tiletamine/zolazepam 7.7–11.5 mg/kg IM	Bathgate et al., 1992 Pye, 2001 Schobert, 1987

^aReversal with yohimbine 0.2 mg/kg IV or atipamezole 0.05–0.4 mg/kg IV.

^bProvided with heat during anesthesia to prevent torporous state.

TABLE 17-2
SEDATIVES AND TRANQUILIZERS—SHORT-TAILED OPOSSUM, VIRGINIA
OPOSSUM, SUGAR GLIDER

Drug	Dosage and route	References
Diazepam	0.5–2 mg/kg IM, PO, IV	Johnson-Delaney, 2006
Butorphanol	0.1–0.4 mg/kg SQ, IM q 6–8 hours	Johnson-Delaney, 2006
Medetomidine	0.05–0.1 mg/kg IM with ketamine 2–3 mg/kg IM	Johnson-Delaney, 2006
Diazepam (sugar glider)	0.5–1.0 mg/kg IM	Carpenter, 2005

Tupaia glis (common tree shrew)

Order Insectivora

Family Soricidae

Suncus etruscus (Etruscan, pygmy shrew)

Suncus murinus (Asian house musk shrew)

Sorex araneus (long-tailed shrew)

Cryptotis parva (small-eared shrew)

A. Family Tupaiidae

1. Common Tree Shrew—*Tupaia glis*

The common tree shrew is a 142 g squirrel-sized omnivore classified as a primate in 1965 due to musculature, brain, skull, and eye development and reproductive characteristics, but later reclassified in the Order Scandentia, a highly specialized insectivore (Lundrigan and Cisneros, 2005). Research applications

include ophthalmology (Cao et al., 2003; Siegwart and Norton, 2005), neurology (Remple et al., 2006; Chuncher and Somana, 2006), gallstone induction (Schwaier, 1979), hepatocellular carcinoma (Cao et al., 2003), and kinematics (Fischer et al., 2002; Vinyard et al 2005).

B. Family Soricidae

1. Etruscan or Pygmy Shrew—*Suncus etruscus*

The pygmy shrew is the smallest living mammal weighing 1.8–3 g and measuring 1.38–1.97 in. long. It has a high metabolic rate with high-energy demands, eating crickets and mealworms in captivity (Ferry and Olson, 2005). Uses in biomedical research include studies of muscle physiology (Anjum et al., 2006; Peters et al., 1999), metabolism (Magnanou et al., 2005), and oxygen transport (Fons et al., 1997).

2. Asian House Musk Shrew—*Suncus murinus*

The musk shrew is a mouse-sized insectivore (23–147 g) with a high metabolic rate requiring multiple feeding periods (Fig. 17-3). They are invasive and emit a musky odor thwarting predators (Lench and Yahnke, 2004). Uses in research include studies of periodontitis (Takata et al., 1999), behavior (Tsuji et al., 1999), emesis (Lau et al., 2005; Uchino et al., 2006), metabolism (Suzuki et al., 2006; Takeuchi et al., 2006), immunology (Suzumoto et al., 2006), gastroenterology (Yi et al., 2006), and reproductive physiology (Kaneko et al., 2003; Temple, 2004).

TABLE 17-3
ANALGESICS FOR SMALL MARSUPIAL SPECIES

Species	Drug	Dosage and route	References
Short-tailed opossum	Buprenorphine	0.01 mg/kg SQ, IM q 8 hours	Johnson-Delaney, 2006
	Butorphanol	0.1–0.5 mg/kg SQ, IM q 6–8 hours	Johnson-Delaney, 2006
	Carprofen	1.0 mg/kg PO, SQ q 12–24 hours	Johnson-Delaney, 2006
	Meloxicam	0.2 mg/kg PO SQ q 24 hours	Johnson-Delaney, 2006
Virginia opossum	Buprenorphine	0.1 mg/kg SQ, IM q 8–12 hours	Johnson-Delaney, 2006
	Butorphanol	0.1–0.5 mg/kg SQ, PO q 6–8 hours	Johnson-Delaney, 2006
	Carprofen	1.0 mg/kg PO, SQ q 12–24 hours	Johnson-Delaney, 2006
	Meloxicam	0.2 mg/kg PO, SQ q 24 hours	Johnson-Delaney, 2006
Sugar glider	Buprenorphine	0.01 mg/kg SQ, IM q 6–8 hours	Johnson-Delaney, 2006
		0.01–0.05 mg/kg IM q 8–12 hours	Pye, 2001
	Butorphanol	0.2–0.5 mg/kg IM q 8 hours	Pye, 2001
		0.5 IM mg/kg	Pollock, 2002
	Butorphanol	0.5 IM mg/kg q 8 hours	Carpenter, 2005
		1.7 mg/kg plus acepromazine 1.7 mg/kg, both given PO to prevent self-trauma at incision site	Carpenter, 2005
	Ketamine	10 mg/kg plus acepromazine 1 mg/kg, both given SQ to prevent self-trauma at incision site	
	Morphine	0.1 mg/kg SQ, IM q 6–8 hours	Johnson-Delaney, 2006
	Carprofen	1.0 mg/kg PO, SQ q 24 hours	Johnson-Delaney, 2006
	Meloxicam	0.2 mg/kg PO, SQ q 24 hours	Johnson-Delaney, 2006
Flunixin meglumine	0.1–1.0 mg/kg IM q 12–24 hours	Carpenter, 2005	



Fig. 17-3 Musk shrew—*Suncus murinus*.

Photo credit: American Society of Mammalogists, Mammal Images Library.



Fig. 17-4 Small-eared shrew—*Cryptotis parva*.

Photo credit: American Society of Mammalogists, Mammal Images Library.

3. Eurasian Shrew—*Sorex araneus*

The Eurasian shrew, a small insectivore weighing 5–14 g, burrows underground and eats primarily earthworms and spiders (Taylor, 2002). Uses in research include studies of neurology (JN et al., 2006), evolutionary genetics (Bannikova et al., 2006; Bassett et al., 2006), metabolism (Ochocinska and Taylor, 2005), and ophthalmology (Peichl et al., 2000).

4. Small-eared Shrew—*Cryptotis parva*

The least shrew, weighing from 4 to 6.5 g, plays a valuable role in controlling insects throughout the Americas (Fox, 1999a, 1999b) (Fig. 17-4). Uses in research include studies of

environmental toxicology (Darmani et al., 2005; Mock et al., 2005), emesis (Darmani and Crim, 2005), and renal physiology (Goldstein and Newland, 2004).

C. Manual Restraint

Clear acrylic tubes facilitate visual examination of shrews and hedgehogs without stress associated with manual restraint (Barbiers, 2003; Isenbugel and Baumgartner, 1993). Repeated attempts and prolonged restraint may lead to cardiogenic shock and death (Isenbugel and Baumgartner, 1993). Gloves should

be worn when handling species (e.g., *Sorex cinereus*, *Solenodon paradoxus*) that produce venom from submaxillary glands (Barbiers, 2003). Heavy stroking over the back or holding the head downward toward a surface encourages the reluctant hedgehog to unroll (Pye, 2001).

D. Chemical Restraint

Isoflurane administered by face mask or induction chamber (3–5%) with face mask maintenance (0.5–3.0%) is the

TABLE 17-4
INJECTABLE ANALGESICS FOR HEDGEHOGS (WHICH MAY BE
APPLIED TO OTHER INSECTIVORES)

Drug	Dosage and route	References
Buprenorphine	0.1 mg/kg SQ, IM q 6–8 hours	Carpenter, 2005
	0.01–0.5 mg/kg SQ, IM q 8–12 hours	Carpenter, 2005
	0.01 mg/kg SQ IM q 6–8 hours	Johnson-Delaney, 2006
Butorphanol	0.05 mg/kg SQ q 8 hours	Carpenter, 2005
	0.05–0.1 mg/kg SQ, IM q 8 hours	Carpenter, 2005
	0.2–0.4 mg/kg SQ, IM q 6–8 hours	Carpenter, 2005
	0.05–0.4 mg/kg SQ, IM q 6–8 hours	Johnson-Delaney, 2006
Morphine	0.1 mg/kg IM	Johnson-Delaney, 2006
Naloxone	0.1 mg/kg SQ, IM q 6–8 hours	Johnson-Delaney, 2006
Flunixin meoglumine	0.03 mg/kg IM q 8 hours	Carpenter, 2005
	0.3 mg/kg SQ q 24 hours	Carpenter, 2005
Carprofen	1.0 mg/kg PO, SQ q 12–24 hours	Johnson-Delaney, 2006
Meloxicam	0.2 mg/kg PO, SQ q 24 hours	Johnson-Delaney, 2006

anesthetic of choice (Barbiers, 2003; Carpenter, 2005; Isenbugel and Baumgartner, 1993; Wallach and Boever, 1983). Endotracheal intubation with feeding tubes or catheters is possible but difficult due to the small oral cavity (Barbiers, 2003; Carpenter, 2005). Premedication with butorphanol (0.05–0.4 mg/kg SQ) or buprenorphine (0.01 mg/kg SQ) contributes to a smooth induction in an inhalation chamber (Hernandez-Divers, 2004). Monitor body temperature, since small body size may predispose to hypothermia during anesthetic episodes. Small shrews may be at risk of hyperthermia during stress (Barbiers, 2003). Injectable analgesics (Table 17-4) and anesthetics (Table 17-5) are typically given intramuscularly into the orbicularis panniculi muscle between spines, the anterior thigh musculature, or triceps muscle of hedgehogs. The orbicularis panniculi muscle, which allows the hedgehog to curl up into a ball, extends from the skull over the midline and laterally to the nonspiny, haired ventrum. Avoid the dorsal neck region as an injection site due to the presence of brown fat which may delay absorption. Preanesthetic treatment with atropine 0.01–0.04 mg/kg IM is recommended for hedgehogs (Carpenter, 2005) and should be considered for other insectivores.

E. Blood Collection

Small samples may be collected from the lateral saphenous, cephalic, jugular, or femoral veins. Hematocrits may decrease significantly during hibernation (Barbiers, 2003; Wallach and Boever, 1983).

III. RODENTIA: NONTRADITIONAL SPECIES OF LABORATORY RODENTS

Rodents other than *Rattus norvegicus*, *Mus musculus*, *Cavia porcellus*, and *Meriones unguiculatus* described below offer unique anatomic and physiologic characteristics making them valuable for scientific studies (Fine et al., 1986).

TABLE 17-5
INJECTABLE ANESTHETICS FOR INSECTIVORES

Drug	Dosage and route	Comments	References
Diazepam	0.5–2.0 mg/kg IM	Mild sedation	Barbiers, 2003; Carpenter, 2005; Johnson-Delaney, 2006
Ketamine	5–20 mg/kg IM	Used in combination with xylazine or valium	Barbiers, 2003; Carpenter, 2005
Medetomidine	0.05–0.1 mg/kg IM	Light sedation	Carpenter, 2005; Johnson-Delaney, 2006
	0.2 mg/kg IM	Heavy sedation	Johnson-Delaney, 2006
Medetomidine plus ketamine plus fentanyl	0.2 mg/kg SQ; 2.0 mg/kg SQ; 0.1 MG/kg SQ	Reverse with atipemazole 1.0 mg/kg IM; reverse with naloxone 0.16 mg/kg IM	Barbiers, 2003; Carpenter, 2005
Ketamine plus medetomidine	5 mg/kg IM; 0.1 mg/kg IM	Reverse with atipamezole 0.3–0.5 mg/kg IM	Carpenter, 2005
Ketamine plus xylazine	10–20 mg/kg IM; 2 mg/kg IM		Wallach and Boever, 1983
Ketamine plus xylazine	10 mg/kg IM; 2 mg/kg IM	For endotracheal intubation of tree shrew	Ohl et al., 1999
Ketamine plus xylazine	10–20 mg/kg IM; 1 mg/kg IM	20–30 minutes anesthesia in shrews	Isenbugel and Baumgartner, 1993
Tiletamine/zolazepam	1–5 mg/kg IM	Prolonged recovery	Barbiers, 2003; Carpenter, 2005
Xylazine	0.5–1.0 mg/kg IM	Given with ketamine; reverse with Yohimbine 0.5–1.0 mg/kg IM	Barbiers, 2003; Carpenter, 2005

Order Rodentia (from Latin, *rodere*, to gnaw)

Suborder Castorimorpha

Family Geomyidae: pocket gophers (true gophers)

Family Heteromyidae: kangaroo rats and kangaroo mice

Suborder Myomorpha

Family Cricetidae: hamsters, rice rat, pack rat, voles

Family Muridae: true mice & rats, gerbils, multimammate rat, sand rat, cotton rat

Family Nesomyidae: white-tailed rat

Suborder Sciuromorpha

Family Sciuridae: squirrels, woodchucks, prairie dogs

Suborder Hystricomorpha

Family Chinchillidae: chinchillas, viscachas

Family Octodontidae: degu

Family Caviidae: cavies, guinea pigs

A. Suborder Castorimorpha

Castorimorphs include beavers, pocket gophers, and kangaroo rats. All rodents in this suborder have a sciuromorphic zygomatic system where the ventral surface of the zygoma tilts and broadens into a zygomatic plate with the masseter lateralis extending forward onto the rostrum and the masseter superficialis extending forward along the zygoma (Korth and Emry, 1991).

1. Family Geomyidae

a. Pocket gopher—*Geomys* sp., *Thomomys* sp.

Pocket gophers are small rat-sized rodents with fur-lined cheek pouches; these are found in the Canadian and U.S. Rocky Mountains (Donnelly and Quimby, 2002) (Fig. 17-5). Research applications include studies of molecular evolution (Donnelly



Fig. 17-5 Pocket gopher—*Geomys* sp.

Photo credit: American Society of Mammalogists, Mammal Images Library.

and Quimby, 2002), reproduction (Ewel, 1972), thermoregulation (Bradley and Yousef, 1975), and hearing (Heffner and Heffner, 1990).

2. Family Heteromyidae

a. Kangaroo rat—*Dipodomys* sp.

Two species of kangaroo rats (*D. spectabilis* and *D. merriami*) weigh 35–180 g, hop like kangaroos and are found throughout the western United States (Fig. 17-6). Uses in research include studies of behavior (Preston and Jacobs, 2005), renal physiology, water conservation (Banta and Holcombe, 2002), and decompression sickness (Donnelly and Quimby, 2002).

B. Suborder Myomorpha

Myomorphs include hamsters, rats, mice, gerbils, and voles. All rodents in this suborder have a myomorphous zygomatic system where masseter muscles extend over an expanded and tilted zygoma as seen in sciuriforms and an enlarged foramen seen in hystricomorphs (Korth and Emry, 1991).

1. Family Cricetidae

a. Rice rat—*Oryzomys palustris*

The rice rat is a 40–80 g South American rat used for studies of periodontal disease (Donnelly and Quimby, 2002), reproduction (Donnelly and Quimby, 2002; Edmonds and Stetson, 1995; Edmonds et al., 2003), and environmental toxicology (Donnelly and Quimby, 2002; Smith et al., 2006a, 2006b) (Fig. 17-7).



Fig. 17-6 Kangaroo rat—*Dipodomys* sp.

Photo credit: American Society of Mammalogists, Mammal Images Library.



Fig. 17-7 Rice rat—*Oryzomys palustris*.
Photo credit: American Society of Mammalogists, Mammal Images Library.



Fig. 17-8 Allegheny wood rat—*Neotoma floridana*.
American Society of Mammalogists, Mammal Images Library.

b. Pack rat—*Neotoma* sp.

The five species of wood rats used in research (*N. floridana*, *N. albigula*, *N. mexicana*, *N. cinerea*, and *N. fuscipes*) are most well known for their foraging behavior of carrying shiny objects to large nests (Fig. 17-8). Research applications include studies of infectious disease, parasitology, toxicology (Boyle and Dearing, 2003; Dearing et al., 2006), and snake venom toxicology (Donnelly and Quimby, 2002).

c. White-footed or deer mouse—*Peromyscus* sp.

Two species of deer mice (white-footed mouse—*P. leucopus* and deer mouse—*P. maniculatus*), weighing 19–22 g, range



Fig. 17-9 Deer mouse—*Peromyscus maniculatus*.
American Society of Mammalogists, Mammal Images Library.



Fig. 17-10 Meadow vole—*Microtus pennsylvanicus*.
Photo credit: American Society of Mammalogists, Mammal Images Library.

throughout North America (Fig. 17-9). Uses in biomedical research include studies of zoonoses (Rizvanov et al., 2006), reproduction (Trainor et al., 2006), genetics, physiology, aging, cataracts, and behavior (Donnelly and Quimby, 2002; Martin et al., 2006).

d. Voles and meadow mice—*Microtus* sp.

Seven species of voles weighing 30–40 g are found in Europe and North America (Fig. 17-10). Uses in research include studies of thermogenesis (Wang et al., 2006), reproductive physiology (Bales et al., 2007; Hayes and De Vries, 2007), cardiology (Grippio et al., 2007), environmental toxicology (Smith et al., 2006a, 2006b), nutrition, epilepsy, behavior, infectious and parasitic disease, diabetes mellitus, and atherogenic diets (Donnelly and Quimby, 2002).



Fig. 17-11 Grasshopper mouse—*Onychomys torridus*. Photo credit: American Society of Mammalogists, Mammal Images Library.

e. Cane mice—*Zygodontomys brevicauda*

The cane mouse, weighing about 100 g, is found throughout Central and South America. Uses in research include studies of reproduction, photoperiod, and infectious disease (Donnelly and Quimby, 2002; Fulhorst et al., 1999).

f. Grasshopper mouse—*Onychomys* sp.

Two species of the grasshopper mouse (*O. torridus* and *O. leucogaster*), weighing 30–60 g, are found in prairies and deserts of North America from Canada through Mexico (Fig. 17-11). Uses in research include studies of muscle physiology (Satoh and Iwaku, 2006), infectious and parasitic diseases, cancer induction, and epilepsy (Donnelly and Quimby, 2002).

2. Family Muridae (includes *Mus mus*, *Rattus norvegicus*)

a. Sand rat—*Psammodys obesus*

The fat sand rat, found in North Africa, weighs 125–208 g and has black skin, large black eyes, a black tail tip fur tuft, and light brown to red body fur (Biagi and Myers, 2004). Biomedical research applications for the obese sand rat include studies of the pancreas (Jorns et al., 2006; Vedtofte et al., 2007), nutritionally induced type 2 diabetes (Kaiser et al., 2005; Shafir et al., 2006), fatty liver (Maislos et al., 2006), and disk degeneration and spondylosis (Adler et al., 1983).

b. Multimammate rat—*Mastomys natalensis*

The multimammate rat, an African rodent, weighs 20–80 g and has 8–18 pairs of mammary glands (Donnelly and Quimby,

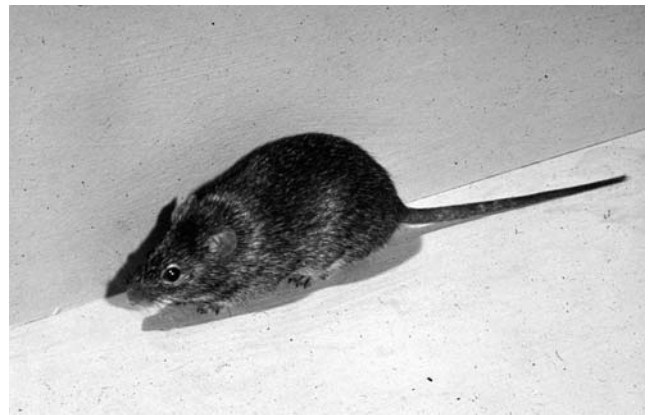

Fig. 17-12 Cotton rat—*Sigmodon hispidus*. Photo credit: American Society of Mammalogists, Mammal Images Library.

2002). Uses in biomedical research include studies of parasitology (Holt et al., 2006; Hurkova-Hoffmanova et al., 2007), renal physiology (Ntshotsho et al., 2004), and carcinogenesis (Helfrich et al., 2004; Koga et al., 2002).

c. Cotton rat—*Sigmodon hispidus*

The cotton rat weighing 80–130 g is found from the Mid-Atlantic United States through Argentina (Donnelly and Quimby, 2002; Sainsbury, 2003) (Fig. 17-12). They resist manual restraint and are best handled with gloves or mechanically restrained in transfer tubes or nest boxes. Uses in research include studies of infectious (Ottolini et al 2005; Williams et al., 2005; Yim et al., 2005) and parasitic disease, carcinogenesis, and environmental toxicology (Donnelly and Quimby, 2002).

3. Family Nesomyidae

a. White-tailed rat—*Mystromys albicaudatus*

The white-tailed rat is an African rat weighing 75–185 g (Donnelly and Quimby, 2002) used in studies of infectious disease (Shepherd et al., 1989; Waggle et al., 1986), parasitology (Donnelly and Quimby, 2002), diabetes mellitus (Donnelly and Quimby, 2002), and carcinogenesis (Roebuck and Longnecker, 1979; Yamamoto et al., 1972).

C. Manual Restraint

Nontraditional species of laboratory rats, mice, voles, and gophers described above are commonly fractious and difficult to manually restrain. In *Rattus* sp. and *Mus* sp., manual restraint techniques should be performed using gloves and with great caution to avoid tail injury (degloving or amputation) if the animal struggles (Cantwell, 2001; Carpenter, 2005, Donnelly and Quimby, 2002; Sainsbury, 2003).

D. Chemical Restraint

Isoflurane inhalation anesthesia via induction chamber (3–5%) minimizes complications with manual restraint of wild or easily stressed rodents (Cantwell, 2001; Carpenter, 2005;

Donnelly and Quimby, 2002; Sainsbury, 2003) and is the method preferred by the author. Sedatives and tranquilizers administered 30–60 minutes prior to face mask (0.5–3%) or chamber induction may ensure a smoother induction (Table 17-6). Inhalation anesthetic administration in rodents that are difficult to handle may best be accomplished by placing the rodent inside an opaque nest box or an extending tube from the home cage into an induction chamber. Frequent observations of depth of anesthesia are required if the rodent cannot easily be seen inside the nest box. Dangerously high levels of anesthetic may be produced when using a chamber with cotton or gauze soaked in inhalant anesthetic (Sainsbury, 2003). Once the righting reflex is lost, anesthesia in nontraditional laboratory rodents may be maintained by inhalation anesthesia (face mask or intubation) or by injectable agents (Tables 17-7–17-9). The author also uses injectable anesthetics and analgesics recommended for *M. musculus* and *R. norvegicus* in nontraditional mouse and rat species. Atropine administered at 0.05 mg/kg SQ (Sainsbury, 2003) or 0.1–0.2 mg/kg IM or SQ (Carpenter, 2005) or glycopyrrolate at 0.01–0.02 mg/kg SQ (Carpenter, 2005) reduces oral and respiratory mucus secretions.

E. Intraoperative Management

For prevention of tissue trauma, hypovolemia, and hypothermia, nontraditional laboratory mouse, rat, and gopher species should be given the same attention as given to *M. musculus* and *R. norvegicus*. Subcuticular, absorbable sutures reduce post-operative chewing of sutures and hence eliminate the need for handling for suture removal (Sainsbury, 2003).

TABLE 17-6

SEDATIVES AND TRANQUILIZERS FOR ALL
NONTRADITIONAL MOUSE AND RAT SPECIES
(ESPECIALLY USEFUL 30–60 MINUTES PRIOR TO
ISOFLURANE MASK OR CHAMBER INDUCTION)

Drug	Dosage
Diazepam	2.5–5.0 mg/kg IP
Midazolam	2.5–5.0 mg/kg IP
Acepromazine	0.5–5.0 mg/kg IP

All dosages are from Sainsbury (2003).

TABLE 17-8

ANALGESICS FOR NONTRADITIONAL LABORATORY MICE AND RATS

Drug	Dosage
Buprenorphine	0.01–0.05 mg/kg SQ q 8–12 hours
Butorphanol	1–5 mg/kg SQ q 3–4 hours
Flunixin meglumine	2–5 mg/kg SQ q 8–12 hours

All dosages are from Sainsbury (2003).

TABLE 17-7

INJECTABLE ANESTHETICS FOR ALL NONTRADITIONAL LABORATORY RAT AND MOUSE SPECIES

Drug	Dose	Reversal
Ketamine plus diazepam	20–100 mg/kg IP/IM; 2–8 mg/kg IP/IM	na
Ketamine plus acepromazine	40–150 mg/kg IP/IM; 0.5–5.0 mg/kg IP/IM	na
Tiletamine/zolazepam	22–80 mg/kg IM/IP	na
Alphaxolone/alphadolone (Saffan™)	40–150 mg/kg IP	na
Fentanyl/fluanisone/midazolam (Hypnorm/Hypnovel™)	2.7–10 ml/kg IP ^a	Butorphanol 2 mg/kg IP
Fentanyl/fluanisone (Hypnorm™)	0.4–1.0 ml/kg	Butorphanol 2 mg/kg IP
Fentanyl/droperidol (Innovar Vet™)	0.44–0.9 ml/kg IM	Butorphanol 2 mg/kg IP
Ketamine plus medetomidine	40–100 mg/kg; 0.25–1.0 mg/kg IP	Atipemazole

All dosages are from Sainsbury (2003).

^aOne part of fentanyl/fluanisone plus two parts of sterile water and one part of midazolam (5 mg/ml initial concentration).

TABLE 17-9
SPECIES-SPECIFIC DRUGS

Species	Drug	Dosage and route	References
White-tailed rat	Sodium pentobarbital	60 mg/kg IP	Donnelly and Quimby, 2002 Padovan, 1985
	Sodium pentobarbital	40–50 mg/kg IP	
Pack rat (wood rat)	Ketamine	30–110 mg/kg IM	Donnelly and Quimby, 2002
Degu	Ketamine plus diazepam	40–50 mg/kg IM; 0.8–1 mg/kg IM	Clark and Olfert, 1986
	Diazepam	1–5 mg/kg IM, PO, IV—sedation	Johnson-Delaney, 2006
	Butorphanol	1–5 mg/kg SQ q 4 hours—sedation	Johnson-Delaney, 2006
	Medetomidine	0.1 mg/kg SQ—sedation	Johnson-Delaney, 2006
	Buprenorphine	0.05 mg/kg SQ q 8–12 hours—analgesia	Johnson-Delaney, 2006
	Butorphanol	0.4–2.0 mg/kg SQ q 8–12 hours—analgesia	Johnson-Delaney, 2006
	Meperidine	10–12 mg/kg SQ q 2–3 hours—analgesia	Johnson-Delaney, 2006
	Morphine	2–5 mg/kg SQ q 4 hours—analgesia	Johnson-Delaney, 2006
	Naloxone	0.05 mg/kg SQ, IP once—analgesia	Johnson-Delaney, 2006
	Oxymorphone	0.2–0.5 mg/kg q 6–12 hours—analgesia	Johnson-Delaney, 2006
<i>Peromyscus</i> sp.	Ketamine plus xylazine	50 mg/kg IM; 50 mg/kg IM provides 31–79 minutes of anesthesia	Silverman and Ingram, 1986
All species of mice	Ketamine	30–40 mg/kg IM (short-term chemical restraint)	Wallach and Boever, 1983
	Sodium pentobarbital	30–70 mg/kg IP (dilute stock solution 1:10)	Wallach and Boever, 1983
	Fentanyl/droperidol (Innovar Vet™)	0.5–0.7 ml/kg IM	Wallach and Boever, 1983

F. Recovery

A recovery area for small rodents (<500 g) and larger rodents should be 35–37°C and 25–35°C, respectively. Ambient temperature should be reduced to 20–25°C once the righting reflex returns. Dusty bedding should be avoided to prevent airway obstruction. Isotonic fluids (50–100 ml/kg) warmed to 37°C and administered subcutaneously may prevent postoperative dehydration (Carpenter, 2005; Sainsbury, 2003).

G. Suborder Sciuromorpha

Sciuromorphs include dormice, squirrels, chipmunks, prairie dogs, and woodchucks. All rodents in this suborder have a sciuromorphic zygomaseteric system where the ventral surface of the zygoma tilts and broadens into a zygomatic plate with the masseter lateralis extending forward onto the rostrum and the masseter superficialis extending forward along the zygoma (Korth and Emry, 1991).

1. Family Sciuridae—Squirrels, Prairie Dogs, Woodchucks

a. Ground squirrels—*Spermophilus* sp.

The two species of ground squirrel most commonly used in research, *S. richardsonii* (Richardson's ground squirrel) and *S. tridecemlineatus* (13-lined ground squirrel) inhabit the prairies, tundra, and mountain deserts of northwestern United States and western Canada. Ground squirrels weigh 85–1,000 g doubling their weight prior to hibernation. Uses in research include studies of hibernation, hepatitis B infection, hepatocellular

TABLE 17-10

INJECTABLE ANESTHETICS FOR GROUND SQUIRRELS

Drug	Dosage
Ketamine plus xylazine ^a	85.5 (±3.4) mg/kg IM; 10.6 (±0.5) mg/kg IM caudal thigh
Ketamine plus xylazine ^a	85.6 (±4) mg/kg SQ; 10.7 (±0.7) mg/kg SQ scruff of neck

All dosages are from Olson and McCabe (1986).

^aProvides 20–30 minutes of surgical anesthesia in Richardson's ground squirrels with induction time of 1–2 minutes and no respiratory depression.

carcinoma, and cholesterol gallstone formation (Donnelly and Quimby, 2002).

Manual restraint: Wild-caught ground squirrels are difficult to manually restrain. They may be transferred from a nestbox to a sac by placing the nest box in a sac and opening the nest box. The squirrel is subsequently anesthetized using injectables through the sac or by isoflurane induction in a chamber (Sainsbury, 2003).

Chemical restraint: Induction using isoflurane in a chamber (3–5%) requires minimal handling and reduces the likelihood of trauma from handling (Sainsbury, 2003). Anesthesia is maintained by administering isoflurane (0.5–3%) via a mask, an endotracheal tube, or injectables (Table 17-10).

b. Black-tailed prairie dog—*Cynomys ludovicianus*

Black-tailed prairie dogs are squirrel-like rodents weighing 0.7–1.4 kg and inhabiting the Great Plains from southern

Saskatchewan to northern Mexico (Donnelly and Quimby, 2002) (Fig. 17-13). Uses in research include studies of biliary physiology, gallstone formation, clostridial diarrhea, oxygen consumption, hibernation, and monkeypox infection (Donnelly and Quimby, 2002; Harlow and Braun, 1995; Wallach and Boever, 1983; Xiao et al., 2005).

Manual restraint: Manual restraint is not recommended because most prairie dogs are wild caught, since captive breeding is problematic. Leather gloves should be used if manual restraint is required. Stressed prairie dogs will prolapse anal glands and may become dyspneic, since they are obligate nasal breathers (Klaphake, 2006).

Chemical restraint: Isoflurane inhalation anesthesia via induction chamber (3–5%) followed by face mask or endotracheal intubation to effect requires minimal handling of uncooperative animals (Hernandez-Divers, 2004; Johnson-Delaney, 2006; Sainsbury, 2003) and is recommended by the author. Pre-medication with butorphanol (0.2 mg/kg SQ, IM) contributes to a smooth induction (Hernandez-Divers, 2004). Injectable anesthetics including combinations of ketamine with acepromazine, xylazine, and diazepam provide short-term anesthesia (Table 17-11). Sedatives and analgesics for prairie dogs, including diazepam, butorphanol, medetomidine, meperidine, morphine, naloxone, oxymorphone, carprofen, and meloxicam, are listed in Table 17-12.



Fig. 17-13 Black-tailed prairie dog—*Cynomys ludovicianus*.
Photo credit: American Society of Mammalogists, Mammal Images Library.

c. Woodchuck—*Marmota monax*

The eastern woodchuck, a 2.5–5.0-kg sciurid rodent, is found throughout the midwestern and eastern United States and southern Canada (Bellezza et al., 2002) (Fig. 17-14). Woodchucks, as obligate hibernators, experience a doubling of body weight in the summer while preparing for hibernation and 50% weight loss during fall and winter hibernation (Bellezza et al., 2002; Young and Sims, 1979). They are used in research programs to study viral hepatitis, obesity, energy balance, and hibernation (Bellezza et al., 2002; McKenzie et al., 2006; Young and Sims, 1979).

Manual restraint: Elkhide elbow-length leather gloves are used, to protect against serious bites from aggressive individuals. The woodchuck is pinned behind the neck with one hand while the opposite hand grasps the base of the tail for subsequent intramuscular injections (alternating gastrocnemius or quadriceps muscles for serial injections) or placement in an isoflurane anesthesia induction chamber or face mask (Bellezza et al., 2002; McKenzie et al., 2006; Sainsbury, 2003; Young and Sims, 1979).

Chemical restraint: Isoflurane may be administered via induction chamber or face mask (3–5%) and given to effect via face mask or endotracheal intubation for maintenance (Bellezza et al., 2002; Sainsbury, 2003). Injectable anesthetics including combinations of ketamine and xylazine; fentanyl and droperidol; pentobarbital; ketamine and medetomidine; and xylazine, tiletamine, and zolazepam are listed in Table 17-13. Consideration must be given to seasonal body condition (i.e., fat content) when anesthetizing wild or hibernating marmots (Beiglbock and Zenker, 2003; Young and Sims, 1979).

H. Suborder Hystricomorpha—Chinchillas, Guinea Pigs, Degus

Hystricomorphs include porcupines, guinea pigs, chinchillas, agoutis, pacas, mole rats, and sand rats. All rodents in this suborder have a hystricomorphous zygomaseteric system including an enlarged masseter medialis passing through an enlarged infraorbital foramen, a masseter superficialis originating on the front edge of the zygoma, and a masseter lateralis extending over most of its length (Korth and Emry, 1991).

TABLE 17-11

INJECTABLE ANESTHETICS FOR PRAIRIE DOGS

Drug	Dosage and route	References
Ketamine plus acepromazine	40–50 mg/kg IM; 0.4–0.5 mg/kg IM	Clark and Olfert, 1986
Ketamine plus xylazine	100–150 mg/kg IM; 10–20 mg/kg IM	Clark and Olfert, 1986
Yohimbine (reversal)	0.5–1.0 mg/kg IV	Carpenter, 2005
Ketamine plus diazepam	20–30 mg/kg IM; 0.4–0.6 mg/kg IM	Clark and Olfert, 1986
Ketamine plus midazolam	5–10 mg/kg IM; 0.5–1.0 mg/kg IM	Carpenter, 2005
Propofol	3–5 mg/kg IV	Carpenter, 2005

TABLE 17-12
SEDATIVES AND ANALGESICS FOR PRAIRIE DOGS

Drug	Dosage and route	References
Diazepam	1–5 mg/kg IM, IP, IV—sedative	Johnson-Delaney, 2006
Butorphanol	2 mg/kg SQ q 2–4 hours—sedative	Johnson-Delaney, 2006
Medetomidine	0.1–0.3 mg/kg—sedative	Johnson-Delaney, 2006
Buprenorphine	0.01–0.05 mg/kg SQ, IP q 6–12 hours—analgesic	Johnson-Delaney, 2006
Butorphanol	0.4–2.0 mg/kg SQ q 8–12 hours—analgesic	Johnson-Delaney, 2006
Meperidine	10–20 mg/kg SQ q 2–3 hours—analgesic	Johnson-Delaney, 2006
Morphine	2–5 mg/kg SQ q 4 hours—analgesic	Johnson-Delaney, 2006
Naloxone	0.05 mg/kg SQ, IP once—analgesic	Johnson-Delaney, 2006
Oxymorphone	0.2–0.5 mg/kg q 6–12 hours—analgesic	Johnson-Delaney, 2006
Ketoprofen	1–5 mg/kg SQ, IM q 12–24 hours—analgesic	Carpenter, 2005
Carprofen	1 mg/kg PO q 12–24 hours—analgesic	Carpenter, 2005
	1–4 mg/kg PO, SQ q 24 hours—analgesic	Johnson-Delaney, 2006
Meloxicam	0.1–0.2 mg/kg PO, SQ q 24 hours—analgesic	Johnson-Delaney, 2006



Fig. 17-14 Woodchuck—*Marmota monax*.

Photo credit: American Society of Mammalogists, Mammal Images Library.

1. Family Chinchillidae—Chinchillas (*Chinchilla laniger*)

Chinchillas inhabit high elevations (3,000–5,000 m) of the Chilean Andes Mountains. The chinchillas kept as pet or research animals in North America are all descendents of 13 founders wild caught in 1927. They are relatively easy to handle without sedation, breed readily in captivity, have a long lifespan (20 years), and have large, accessible tympanic bullae. Uses in research include studies of otitis media, parasitism, atherosclerosis, cerebral blood flow, and reproduction (Donnelly and Quimby, 2002) (Fig. 17-15).

a. Manual restraint

Chinchillas are relatively easy to handle and best restrained by firmly grasping the base of the tail with one hand and supporting

TABLE 17-13
INJECTABLE ANESTHETICS FOR WOODCHUCKS

Drug	Dosage and route	Comments	References
Ketamine	20 mg/kg IM	Chemical restraint only	Young and Sims, 1979
Ketamine plus xylazine	50 mg/kg IM; 5 mg/kg IM	20 minutes anesthesia plus half dose for supplement	Bellezza et al., 2002
Sodium pentobarbital	2–6 mg/kg IV	Sublingual vein or implanted catheter (20–40 minutes anesthesia)	Bellezza et al., 2002
	50 mg/kg IP	Lean animals in Spring	Young and Sims, 1979
	35 mg/kg IP	Fat animals in Fall	Young and Sims, 1979
Fentanyl/droperidol Innovar Vet™	0.35 ml/kg IM	Reversed with naloxone	Bellezza et al., 2002; Clark and Olfert, 1986
Ketamine plus xylazine	40 mg/kg IM; 3 mg/kg IM	Short-term surgery in Spring lean marmots	Beiglbock and Zenker, 2003 ^a
Ketamine plus xylazine	60 mg/kg IM; 20 mg/kg IM	Short-term surgery in late Summer/Fall fat marmots	Beiglbock and Zenker, 2003 ^a
Ketamine plus xylazine	80 mg/kg IM; 20 mg/kg IM	Long-term surgery in Spring lean marmots	Beiglbock and Zenker, 2003 ^a
Ketamine plus medetomidine	35 mg/kg IM; 0.25 mg/kg IM	Short-term surgery in Spring lean marmots	Beiglbock and Zenker, 2003 ^a
Ketamine plus medetomidine	60 mg/kg IM; 0.2 mg/kg IM	Short-term surgery in late Summer/Fall fat marmots	Beiglbock and Zenker, 2003 ^a
Ketamine plus medetomidine	70 mg/kg IM; 0.5 mg/kg IM	Long-term surgery in Spring lean marmots	Beiglbock and Zenker, 2003 ^a
Tiletamine/zolazepam plus xylazine	15 mg/kg IM; 3 mg/kg IM	Short-term surgery in Spring lean marmots	Beiglbock and Zenker, 2003 ^a
Tiletamine/zolazepam plus xylazine	15 mg/kg IM; 10 mg/kg IM	Short-term surgery in late Summer/Fall fat marmots	Beiglbock and Zenker, 2003 ^a
Tiletamine/zolazepam plus xylazine	20 mg/kg IM; 10 mg/kg IM	Long-term surgery in Spring lean marmots	Beiglbock and Zenker, 2003 ^a

^aFree ranging *Marmota marmota*.

the ventrum with the other hand extending two fingers between the forelegs (Clark and Olfert, 1986; Klaphake, 2006).

b. Chemical restraint

Isoflurane anesthesia may be induced by chamber or mask (3–5%) and maintained to effect by mask or endotracheal intubation (Sainsbury, 2003) or injectable anesthetics (Table 17-14). Atropine (0.1–0.2 mg/kg IM, SQ) or glycopyrrolate (0.01–0.02 mg/kg SQ) reduces oral and respiratory mucus secretions (Carpenter, 2005). Analgesics are listed in Table 17-15.

2. Family Octodontidae

a. Degu—*Octodon degus*

The degu or trumpet-tailed rat weighing 170–300 g is found in the Chilean Andes Mountains (Fig. 17-16). Uses in research

include studies of behavior (Gos et al., 2006; Ovtsharoff et al., 2006), Alzheimer's disease (Inestrosa et al., 2005), sleep, digestion, drug tolerance, diabetes mellitus, and cataract formation (Donnelly and Quimby, 2002).

Analgesics and anesthetics are listed in Table 17-9.

IV. LAGAMORPHA: PIKAS, HARES

Sylvilagus floridanus (eastern cottontail rabbit)

Lepus americanus (snowshoe hare)

Ochotona rufescens (Afghan pika)

Ochotona princeps (Colorado pika)

The order Lagomorpha contains two Families: Leporidae (rabbits and hares) and Ochotonidae (pikas).



Fig. 17-15 Chinchilla—*Chinchilla laniger*.

Photo credit: American Society of Mammalogists, Mammal Images Library.

TABLE 17-15
ANALGESICS FOR CHINCHILLAS

Drug	Dosage and route	References
Acetylsalicylic acid	100–200 mg/kg PO q 6–8 hours	Carpenter, 2005
Buprenorphine	87 mg/kg PO 0.05 mg/kg q 8–12 hours	Pollock, 2002 Carpenter, 2005; Pollock, 2002
Butorphanol	0.2–2.0 mg/kg SQ, IM q 4 hours	Carpenter, 2005; Pollock, 2002
Morphine	2–5 mg/kg SQ q 2–5 hours	Pollock, 2002
Carprofen	4 mg/kg SQ q 24 hours	Carpenter, 2005
Flunixin meglumine	1–3 mg/kg SQ q 12 hours	Carpenter, 2005; Pollock, 2002
Ketoprofen	1 mg/kg SQ, IM q 12–24 hours	Carpenter, 2002

TABLE 17-14
INJECTABLE ANESTHETICS FOR CHINCHILLAS

Drug	Dosage and route	References
Acepromazine	0.5–1.0 mg/kg IM—preanesthetic	Carpenter, 2005
Ketamine	20–40 mg/kg IM (light sedation)	Carpenter, 2005; Clark and Olfert, 1986
Ketamine plus acepromazine	40 mg/kg IM; 0.5 mg/kg IM	Carpenter, 2005
Ketamine plus diazepam	20–40 mg/kg IM; 1–2 mg/kg IM	Carpenter, 2005
Ketamine plus midazolam	5–10 mg/kg IM; 0.5–1.0 mg/kg IM	Carpenter, 2005
Ketamine plus xylazine	35–40 mg/kg IM; 4–8 mg/kg IM	Carpenter, 2005
Yohimbine (reversal)	0.5–1.0 mg/kg IV	Carpenter, 2005
Ketamine plus xylazine	10–20 mg/kg IM; 0.4–0.5 mg/kg IM	Clark and Olfert, 1986
Ketamine plus xylazine	40 mg/kg IM; 2 mg/kg IM	Henke et al., 2004
Ketamine plus medetomidine	5 mg/kg IM; 0.06 mg/kg IM	Henke et al., 2004
Midazolam plus medetomidine plus fentanyl Reversed within 5 minutes with (otherwise 109 minutes anesthesia)	1 mg/kg IM; 0.05 mg/kg IM; 0.02 mg/kg IM	Henke et al., 2004
Flumezanil plus atipemazole plus naloxone	0.1 mg/kg SQ; 0.5 mg/kg SQ; 0.05 mg/kg SQ	Henke et al., 2004
Pentobarbital	35–40 mg/kg P 40 mg/kg IP	Carpenter, 2005 Clark and Olfert, 1986
Tiletamine/zolazepam	20–40 mg/kg IM 40 mg/kg IM 11–44 mg/kg IM	Carpenter, 2005 Clark and Olfert, 1986 Schobert, 1987



Fig. 17-16 Degu—*Octodon degus*.

Photo credit: American Society of Mammalogists, Mammal Images Library.



Fig. 17-17 Snowshoe hare—*Lepus americanus*.

Photo credit: American Society of Mammalogists, Mammal Images Library.

A. Family Leporidae

The genus *Lepus* contains the only true hares. The snowshoe hare, weighing 1.43–1.55 kg, is found throughout Canada and northern United States (Carpenter, 2003) (Fig. 17-17). Uses in research include studies of hybrid fertilization (Marston et al., 1965), brucellosis (Miller and Neiland, 1980), endoparasites (Measures and Anderson, 1983), adrenal function (Smith et al., 1978), and western equine encephalomyelitis (Kiorpes and Yuill, 1975).

The eastern cottontail rabbit, weighing 0.8–1.5 kg, is the most widely distributed of any *Sylvilagus* ranging throughout North America (Mikita, 1999). Uses in research include studies of babesiosis (Spencer et al., 2006) and West Nile Virus viremia (Tiawsirisup et al., 2005).

1. Manual and Chemical Restraint

Techniques for both the snowshoe hare and eastern cottontail rabbit may be adapted from methods published for the laboratory rabbit (*Oryctolagus cuniculi*).

B. Family Ochotonidae

The Afghan and Colorado pika (also called conies or mouse hares), weighing 125–400 g, inhabit the mountains of Afghanistan and western United States and Canada, respectively (Jansa, 1999). The pika's body temperature averages 104.2°F, close to the lethal limit (Carpenter, 2003). The Afghan pika is most commonly used in studies of locomotion (Witte et al., 2002), parasitism (Okamoto et al., 1990), electromyography (Biederman et al., 2000), and iron storage disease (Madarame et al., 1990).

1. Manual and Chemical Restraint

Techniques used in the guinea pig (*C. porcellus*) may be used for the pika (Carpenter, 2003).



Fig. 17-18 Nine-banded armadillo—*Dasypus novemcinctus*.

Photo credit: John Adamski, Seneca Park Zoo, Rochester, NY.

V. XENARTHRA: EDENTATES (ARMADILLOS)

A. Nine-Banded Armadillo—*Dasypus novemcinctus*

The former name of the Order Edentata, containing armadillos, sloths, and anteaters, suggests toothlessness, which is true only for the anteater (Gillespie, 2003) (Fig. 17-18). The new name for the Order Xenarthra, refers to xenarthrous vertebrae, which have secondary articulations between lumbar vertebrae as well as between the ischium and adjacent vertebrae. Xenarthrous vertebrae provide flexibility and support in edentates, especially the armadillo (Gillespie, 2003). *D. novemcinctus*, weighing 3.7–7.7 kg, ranges from southern United States to Argentina. Leathery skin surrounds ossified dermal plates forming a hinged carapace that permits the armadillo to roll up into a ball. After delayed implantation of one fertilized egg and a gestation of 120 days, four same-sex quadruplets are born (Fox, 1999a, 1999b). Armadillos, as well as other edentates, have low thyroid activity, low metabolic rates, and low body temperatures (32–35°C), allowing them to survive long periods of apnea

(30–40 minutes) (Divers, 1986). The nine-banded armadillo is the only edentate commonly used in biomedical research. Uses in research include studies of leprosy (Job, 1991; Job et al., 1993), immunology (Santos-Argumedo et al., 1995), respiratory physiology (Frappell et al., 1998), reproduction (Baggato et al., 2000), and metabolism (Boily and Knight, 2004).

1. Manual Restraint

Armadillos do not usually attempt to bite but have powerful legs and sharp claws that may inflict injury. They may be picked up by their sides (Divers, 1986; Gillespie, 2003). Restraining by the tail alone results in self-injury as the armadillo unexpectedly jerks away from the handler (Gillespie, 1993). The handler must be careful not to get fingers pinched under the carapacial plates as they curl up when handled.

2. Chemical Restraint

Armadillos may hold their breath up to 10 minutes making induction with isoflurane in a chamber or face mask difficult (Divers, 1986; Gillespie, 1993). Premedication with injectable anesthetics followed by administration relaxes the armadillo and minimizes breath holding (Gillespie, 2003). Once induced at 3–5% isoflurane or by injectables, armadillos may be intubated with polyethylene tubing (0.6–1.3 cm) and maintained with 1–2% isoflurane (Divers, 1986; Gillespie, 1993). Table 17-16 lists injectable anesthetics. The thigh is the best site to administer an IM injection (Fournier-Chambrillon et al., 2000). Atropine (0.04 mg/kg IM) controls salivation (Gillespie, 1993; Wallach and Boever, 1983).

3. Blood Collection

Blood may be collected from the superficial femoral vein of an anesthetized armadillo (Divers, 1986) or the caudal tail vein located on the ventrum between the second, third, and fourth bony tail segments (Gillespie, 2003).

VI. CHIROPTERA: BATS

Bats are one of the most widespread mammals on earth second only to rodents (Heard, 2003). The suborders Microchiroptera and Megachiroptera separate small insectivorous from larger fruit-eating bats (Pye, 2001). Three families of Microchiropterans—Phyllostomidae, Vespertilionidae, and Mormoopidae—have been studied in biomedical research (Fine et al., 1986).

Family Phyllostomidae (new world leaf-nosed bats)

Phyllostomus discolor (lesser spear-nosed bat)

Glossophaga soricina (long-tongued bat)

Carollia perspicillata (short-tailed fruit bat)

Desmodus rotundus (common vampire bat)

Family Vespertilionidae (evening bats)

Eptesicus fuscus (big brown bat)

Family Mormoopidae (mustached bats)

Pteronotus parnellii (Parnell's mustached bat)

Uses in research include studies of echolocation (O'Neill, 1985; Sherwood et al., 2005; Zhou and Jen, 2006), West Nile Virus infection (Davis et al., 2005), rabies, equine encephalitis, Herpes simplex infection, reproduction, hibernation, and salivary anticoagulants (Fine et al., 1986) (Figs. 17-19 and 17-20).



Fig. 17-19 Big brown bat—*Eptesicus fuscus*.
Photo credit: American Society of Mammalogists, Mammal Images Library.

TABLE 17-16
INJECTABLE ANESTHETICS FOR ARMADILLOS

Drug	Dosage and route	References
Ketamine plus diazepam	24 mg/kg IM; 0.1 mg/kg IM	Divers, 1986
Ketamine plus acepromazine	10–20 mg/kg IM; 0.1 mg/kg IM	Gillespie, 1993
Sodium pentobarbital	25 mg/kg IV—superficial femoral vein	Divers, 1986
Fentanyl/droperidol Innovar Vet™	0.2–0.25 ml/kg IM	Wallach and Boever, 1983
Tiletamine/zolazepam	8.5 mg/kg IM—up to 40 minutes anesthesia for minor surgery	Fournier-Chambrillon et al., 2000
Ketamine plus xylazine	40 mg/kg IM; 1 mg/kg IM up to 40 minutes anesthesia for minor surgery	Fournier-Chambrillon et al., 2000
Ketamine plus medetomidine	7.5 mg/kg IM; 0.075 mg/kg IM up to 40 minutes anesthesia for minor surgery	Fournier-Chambrillon et al., 2000
...reversed by atipamezole	0.0375 mg/kg IM standing within 1–16 minutes	Fournier-Chambrillon et al., 2000



Fig. 17-20 Parnell's mustached bat—*Pteronotus parnellii*.
Photo credit: American Society of Mammalogists, Mammal Images Library.

A. Manual Restraint

Soft pliable leather gloves and butterfly nets may be used for handling microchiropterans weighing 10–50 g. The body is palmed with wings gently folded while the head is restrained between the thumb and the middle finger with index finger placed on top of the head (Pye, 2001). Care should be taken to avoid bending wings in unnatural positions, traumatizing flapping wings, pulling locked toes causing distal femoral epiphyseal fractures, and injuring teeth while biting gloves (Constantine, 1986; Pye, 2001; Wallach and Boever, 1983). Blowing air on the bat encourages it to relax its jaw (Constantine, 1986). Manual restraint should be minimized to reduce stress and hyperthermia (Heard, 2003).

B. Chemical Restraint

Inhalant anesthesia via face mask or induction chamber (5%) followed by maintenance (2–3%) by face mask is recommended (Pye, 2001) and preferred by the author. Glycopyrrolate (0.01 mg/kg IM) reduces pharyngeal secretions. Microchiropterans should not be preoperatively fasted to prevent hypoglycemia. Under general anesthesia, wings should be folded and the animal placed on a warm water-circulating heating pad. The wing patagium may be irritated and damaged by alcohol- and iodine-containing compounds (Heard, 2003). Dosages for most of the injectable anesthetics described for megachiropterans have not been published for microchiropterans (Heard, 2003; Pye, 2001). Ketamine (10–20 mg/kg IM) plus xylazine (2 mg/kg IM) provides general anesthesia in the little brown bat. Sodium pentobarbital (30–50 mg/kg IP) may be used for general anesthesia as long as rectal temperature is maintained between 37 and 40°C (Wallach and Boever, 1983).



Fig. 17-21 Grizzly bear—*Ursus arctos*.
Photo credit: American Society of Mammalogists, Mammal Images Library.

C. Recovery

Microchiropterans should be lightly wrapped in a drape to prevent erratic wing flapping until they are coordinated well enough to crawl out (Heard, 2003).

D. Blood Collection

The external jugular vein may be used for blood collection but care should be taken to avoid fatal hematoma (Heard, 2003).

VII. CARNIVORA: BEARS, HYENA

A. Grizzly or Brown Bear—*Ursus arctos*

The brown or grizzly bear, weighing 150–750 kg and standing up to 8 ft tall, range in the mountains and meadows of northwestern United States, Canada, and Alaska (Dewey and Ballenger, 2002; Ramsay, 2003). Bears are studied in the wild as well as in zoo and vivarium settings. Grizzly bears housed at Washington State University Bear Center are enrolled in studies of heart, muscle, bone physiology, and disuse osteoporosis during hibernation (Barboza et al., 1998; Farley and Robbins, 1995; Hilderbrand et al., 2000; Nelson et al., 2003). Additional studies of disuse osteoporosis (Donahue et al., 2003, 2006a, 2006b), depression (Tsiouis, 2005), and disuse muscle atrophy (Shavlakadze and Grounds, 2006) make the bear an interesting animal model of human disease (Fig. 17-21).

1. Manual Restraint

Bears may not safely be manually restrained (Ramsay, 2003) but may be trained by operant conditioning to accept handheld injections and oral dosing (author's experience).

TABLE 17-17
INJECTABLE ANESTHETICS FOR GRIZZLY BEARS

Drug	Dosage and route	Reversal
Tiletamine/zolazepam	7–9 mg/kg IM	na
Ketamine plus xylazine	10–11 mg/kg IM; 1–11 mg/kg IM	Yohimbine, 0.125 mg/kg IM, IV
Tiletamine/zolazepam plus medetomidine	2 mg/kg IM; 0.06 mg/kg IM	Atipamezole, 0.3 mg/kg IM, IV

All dosages are from Ramsay (2003). Narcotics (etorphine, carfentanyl) typically used in zoos and free ranging wildlife are also described (Ramsay, 2003).

2. Chemical Restraint

Anesthesia is most commonly induced by the use of projectile darting systems (CO₂ pistol or rifle) or pole syringe administering anesthetic agents (Table 17-17). The neck and shoulder areas of bears have the thinnest fat layer requiring a 2–3 in. needle to ensure intramuscular injection (author's experience; Wallach and Boever, 1983). After induction with injectable agents, anesthesia is best maintained with isoflurane to effect (1.5–3%) administered via endotracheal intubation and is the method preferred by the author.

3. Vascular Access

The lingual, saphenous, and cephalic vein may be used for IV access via catheter or handheld syringe. The jugular vein may also be used for IV access but may be too deep to catheterize without a cutdown (Ramsay, 2003; author's experience).

B. Spotted hyena—*Crocuta crocuta*

The spotted hyena, one of three hyena species, is classified in the subfamily Feloidea, making it more related to felids and viverrids than canines (Ramsay, 2003) (Fig. 17-22). They weigh 40–86 kg and are found in Sub-Saharan Africa. The clitoris and penis of the female and male hyena are quite similar in size while flaccid or erect with a single opening at the tip of the glans clitoris and penis. Due to this unique anatomical characteristic, spotted hyena have emerged as an interesting animal model for studying common urogenital sinus (Baskin et al., 2006). The clitoris is enlarged forming a pseudopenis with no external vagina. The masculinized genitalia and dominant behavior of the female and lifelong androgen secretion by the ovaries makes the breeding colony of hyena maintained at University of California Berkeley interesting animals to study (Browne et al., 2006; Cunha et al., 2005; Glickman et al., 2006; McFadden et al., 2006).

1. Manual Restraint

Hyenas require chemical restraint for safe handling. They may be trained through operant conditioning to offer body



Fig. 17-22 Spotted hyena—*Crocuta crocuta*.
Photo credit: John Adamski, Seneca Park Zoo, Rochester, NY.

TABLE 17-18
INJECTABLE ANESTHETICS FOR HYENA

Drug	Dosage and route	References
Ketamine plus xylazine	4–6 mg/kg IM; 1 mg/kg IM	Baskin et al., 2006
Ketamine plus xylazine	10 mg/kg IM; 2 mg/kg IM	Wallach and Boever, 1983
Ketamine plus xylazine	10 mg/kg IM; 0.5 mg/kg IM	Divers, 1986
Ketamine plus xylazine	13.2 mg/kg IM; 6.3 mg/kg IM	Ramsay, 2003
Yohimbine reversal	0.125 mg/kg IV, IM	
Tolazoline reversal	3.7 mg/kg IV, IM	
Tiletamine/zolazepam	4–6 mg/kg IM	Ramsay, 2003

Vascular access: The cephalic and jugular veins may be used for catheterization or blood collection (Divers, 1986).

limbs for intramuscular injection through a fence (author's experience).

2. Chemical Restraint

Hyena should be preoperatively fasted 12–16 hours as practiced with other carnivores to prevent aspiration of stomach contents. Injectable anesthetics may be delivered by handheld syringes in trained hyena, via projectile dart (blowpipe or CO₂ pistol) or a pole syringe. These are listed in Table 17-18. After induction with an injectable agent, anesthesia may be maintained using isoflurane (1.5–3%) to effect via endotracheal



Fig. 17-23 Mouse lemur—*Microcebus murinus*.

Photo credit: American Society of Mammalogists, Mammal Images Library.

intubation (Divers, 1986; Ramsay, 2003) and is the method preferred by the author. Premedication with atropine (0.04 mg/kg IM) reduces salivation (Divers, 1986).

3. Vascular Access

The cephalic and jugular veins may be used for catheterization or blood collection (Divers, 1986).

VIII. PROSIMII: GRAY MOUSE LEMUR

Prosimians are ancestrally extant primates including lemurs, tarsiers, lorises, and galagos. Recent articles describe the anesthetic management of a variety of prosimians in wild, zoo, or primate center settings as part of behavioral or health assessment studies (Junge, 2003; Junge and Louis, 2005; Miller et al., 2007; Williams et al., 2003).

A. Gray mouse lemur—*Microcebus murinus*

The gray mouse lemur, weighing up to 60 g and found only in the forests of Madagascar, has emerged as an interesting animal model of Alzheimer's disease. The aging, gray mouse lemur develops senile plaques and neurofibrillary changes (Bons et al., 1991, 1994, 1995, 1998; Dhenain et al., 1997) (Fig. 17-23).

1. Manual Restraint

Cotton or thin leather gloves may be used to gently restrain mouse lemurs in a cupped hand. They may be transferred from a

TABLE 17-19
INJECTABLE AGENTS FOR CHEMICAL RESTRAINT OF PROSIMIANS

Drug	Dosage and Route
Acepromazine	0.5–2 mg/kg PO
Diazepam	0.5–2.5 mg/kg PO, IV
Ketamine	10 mg/kg IM
Tiletamine/zolazepam	3–5 mg/kg IM
Medetomidine	0.05 mg/kg IM
Butorphanol	0.4 mg/kg IM

All dosages are from Junge (2003).

TABLE 17-20
INJECTABLE ANESTHETICS FOR PROSIMIANS

Drug	Dosage and route (mg/kg IM)
Ketamine plus medetomidine	5 mg/kg IM; 0.05 mg/kg IM
Butorphanol plus medetomidine plus ketamine	0.4 mg/kg IM; 0.04 mg/kg IM; 3 mg/kg IM
Butorphanol plus medetomidine plus midazolam	0.4 mg/kg IM; 0.04 mg/kg IM; 0.3 mg/kg IM

All dosages are from Junge (2003).

nest box into a cloth sac for subsequent intramuscular injection or placement in an isoflurane induction chamber (Junge, 2003).

2. Chemical Restraint

Mouse lemurs may be placed in an isoflurane induction chamber (3–5%) and maintained to effect via face mask (Junge, 2003). The author's preference for chemical restraint of the mouse lemur is tiletamine/zolazepam (5–10 mg/kg IM) diluted 1:10 in sterile water. Care must be taken to avoid hypothermia during anesthesia just as with any small laboratory animal (Tables 17-19 and 17-20).

3. Vascular Access

No veins are accessible for catheterization but subcutaneous fluids may be given as described for mice and rats. A small blood sample (<0.3 ml) may be collected by advancing a 25-gauge needle on a tuberculin syringe at a 45° angle accessing a coccygeal blood vessel located approximately one-third down the ventral midline of the tail (personal experience and personal communication from E.E. Louis DVM, Omaha Henry Doorly Zoo).

REFERENCES

- Adler, J.H., Schoenbaum, M., and Silberberg, R. (1983). Early onset of disk degeneration and spondylosis in sand rats (*Psammomys obesus*). *Vet. Pathol.* **20**(1), 13–22.
- Anjum, F., Turni, H., Mulder, P.G., van der Burg, J., and Brecht, M. (2006). Tactile guidance of prey capture in Etruscan shrew. *Proc. Natl. Acad. Sci.* **103**(44), 16544–16559.

- Baggato, B., Crossley, D.A., and Burggren, W.W. (2000). Physiological variability in armadillo quadruplets: Within- and between-litter differences. *J. Exp. Biol.* **203**(Pt 11), 1733–1740.
- Bales, K.L., Plotsky, P.M., Young, L.J., Lim, M.M., Grotte, N., Ferrer, E., and Carter, C.S. (2007). Neonatal oxytocin manipulations have long-lasting sexually dimorphic effects on vasopressin receptors. *Neuroscience* **44**(1), 38–45.
- Bannikova, A.A., Bulatova, N.S., and Kramerov, D.A. (2006). Molecular variability in the common shrew *Sorex araneus* L. from European Russia and Siberia inferred from the length polymorphism of DNA regions flanked by short interspersed elements (Inter-SINE PCR) and the relationships between the Moscow and Seliger chromosome races. *Genetika* **42**(6), 737–747.
- Banta, M.R., and Holcombe, D.W. (2002). The effects of thyroxine on metabolism and water balance in a desert-dwelling rodent, Merriam's kangaroo rat (*Dipodomys merriami*). *J. Comp. Physiol.* **172**(1), 17–25.
- Barbiers, R. (2003). "Zoo and Wild Animal Medicine." (M.E. Fowler and R.E. Miller, eds.), 5th ed., pp 304–315. W.B. Saunders, St. Louis.
- Barboza, P.S., Farley, S.D., and Robbins, C.T. (1998). Whole-body urea cycling and protein turnover during hyperphagia and dormancy in growing bears (*Ursus americanus* and *U. arctos*). *Can. J. Zool.* **62**, 406–409.
- Baskin, L.S., Yucel, S., Cunha, G.R., Glickman, S.E., and Place, N.J. (2006). A neuroanatomical comparison of humans and spotted hyena, a natural animal model for common urogenital sinus: Clinical reflections on feminizing genitoplasty. *J. Urol.* **175**(1), 276–283.
- Basset, P., Yannic, G., Brunner, H., and Hausser, J. (2006). Restricted gene flow at specific parts of the shrew genome in chromosomal hybrid zones. *Evol. Int. J. Org. Evol.* **60**(8), 1718–1730.
- Bathgate, R.A.D., Sernia, C., and Gemmel, R.T. (1992). Plasma concentrations of arginine vasopressin in an Australian marsupial, the brushtail opossum, *Trichosurus vulpecula*. *Gen. Comp. Endocrinol.* **88**(2), 217–223.
- Baudinette, R.V., Halpern, E.A., and Hinds, D.S., (1993). Energetic cost of locomotion as a function of ambient temperature and during growth in the marsupial *Potorous tridactylus*. *J. Exp. Biol.* **174**, 81–95.
- Beal, A.M. (1992). Relationships between plasma composition and parotid salivary composition and secretion rates in the potoroine marsupials, *Aepyprymnus rufescens* and *Potorous tridactylus*. *J. Comp. Physiol. [B]* **162**(7), 637–645.
- Beiglbock, C., and Zenker, W. (2003). Evaluation of three combinations of anesthetics for use in free-ranging alpine marmots (*Marmota marmota*). *J. Wildl. Dis.* **39**(3), 665–674.
- Bellezza, C.A., Concannon, P.W., Hornbuckle, W.E., Roth, L., and Tennant, B. (2002). "Laboratory Animal Medicine." (J.G. Fox, L.C. Anderson, F.M. Loew, and F.W. Quimby, eds.), 2nd ed., pp 309–328. Academic Press, San Diego.
- Biagi, T., and Myers, P. (2004). *Psammomys obesus* (On-line), University of Michigan Museum of Zoology Animal Diversity Web, <http://animaldiversity.ummz.umich.edu>
- Biederman, F., Schumann, N.P., Fischer, M.S., and Scholle, H.C. (2000). Surface EMG-recordings using a miniaturized matrix electrode: A new technique for small animals. *J. Neurosci. Methods* **97**(1), 69–75.
- Boily, P., and Knight, F.M. (2004). Cold-induced fever and peak metabolic rate in the nine-banded armadillo (*Dasypus novemcinctus*). *Physiol. Biochem. Zool.* **77**(4), 651–657.
- Bons, N., Jallageas, V., Mestre-Frances, N., Silhol, S., Petter, A., and Delacourte, A. (1995) *Microcebus murinus*, a convenient laboratory animal model for the study of Alzheimer's disease. *Alzheimer Res.* **1**, 83–87.
- Bons, N., Mestre, N., and Petter, A. (1991). Senile plaques and neurofibrillary changes in the brain of an aged lemurian primate, *Microcebus murinus*. *Neurobiol. Aging* **13**, 99–105.
- Bons, N., Mestre, N., Ritchie, K., Petter, A., Podlisky, M., and Selkoe, D., (1994). Identification of amyloid beta protein in the brain of the small, short-lived lemurian primate *Microcebus murinus*. *Neurobiol. Aging* **15**, 215–220.
- Bons, N., Silhol, S., Barbier, V., Mestre-Frances, N., and Albe-Fessard, D. (1998). *Microcebus murinus*, stereotaxic atlas and neurochemistry. *Brain Res. Bull.* **46**(1–2), 1–173.
- Boyle, R., and Dearing, M.D. (2003). Ingestion of juniper foliage reduces metabolic rates in woodrat (*Neotoma*) herbivores. *Zoology* **106**(2), 151–158.
- Bradley, A.J., and Stoddardt, D.M. (1990). Metabolic effects of cortisol, ACTH, adrenalin and insulin in the marsupial sugar glider, *Petaurus breviceps*. *J. Endocrinol.* **127**(2), 203–212.
- Bradley, W.G., and Yousef, M.K. (1975). Thermoregulatory responses in the plains pocket gopher *Geomys bursarius*. *Comp. Biochem. Physiol. A* **52**(1), 35–38.
- Browne, P., Place, N.J., Vidal, J.D., Moore, I.T., Cunha, R., Glickman, S.E., and Conley, A.J. (2006). Endocrine differentiation of fetal ovaries and testes of the spotted hyena (*Crocuta crocuta*): Timing of androgen-independent versus androgen-driven genital development. *Reproduction* **132**(4), 649–659.
- Bryant, S.L., and Rose, R.W. (1985). Effect of cadmium on the reproductive organs of the male potoroo *Potorous tridactylus* (macropodidae). *Aust. J. Biol. Sci.* **38**(3), 305–311.
- Buttery, R.G., Haight, J.R., and Bell, K. (1990). Vascular and avascular retinæ in mammals. A fundoscopic and fluorescein study. *Brain Behav. Evol.* **35**(3), 156–175.
- Cantwell, S.L. (2001). "The Veterinary Clinics of North America, Exotic Animal Practice, Analgesia and Anesthesia." (D.J. Heard, ed.), pp 169–191. W.B. Saunders, Philadelphia.
- Cao, J., Yang, E.B., and Su, J.J. (2003). The tree shrews: Adjuncts and alternatives to primates as models for biomedical research. *J. Med. Primatol.* **32**(3), 123–130.
- Carpenter, J.W. (2003). "Zoo and Wild Animal Medicine." (M.E. Fowler and R.E. Miller, eds.), 5th ed., pp 410–418. W.B. Saunders, St. Louis.
- Carpenter, J.W. (2005). "Exotic Animal Formulary," 3rd ed. Elsevier Saunders, St. Louis.
- Chuncher, S., and Somana, R. (2006). Microvascularization of thalamus and metathalamus in common tree shrew (*Tupaia glis*). *Anat. Embryol.* **211**(3), 173–181.
- Clark, J.D., and Olfert, E.D. (1986). "Zoo and Wild Animal Medicine." (M.E. Fowler, ed.), 2nd ed., 738 pp. W.B. Saunders, Philadelphia.
- Constantine, D.G. (1986). "Zoo and Wild Animal Medicine." (M.E. Fowler, ed.), 2nd ed., pp 632–655. W.B. Saunders, Philadelphia.
- Cunha, G.R., Place, N.J., Baskin, L., Conley, A., Weldele, M., Cunha, T.J., Wang, Y.Z., Cao, M., and Glickman, S.E. (2005). The ontogeny of the urogenital system of the spotted hyena (*Crocuta crocuta*). *Biol. Reprod.* **73**(3), 554–564.
- Darmani, N.A., and Crim, J.L. (2005). Delta-9-tetrahydrocannabinol differentially suppresses emesis versus enhanced locomotor activity produced by chemically diverse dopamine D2/D2 receptor agonists in the least shrew (*Cryptotis parva*). *Pharmacol. Biochem. Behav.* **80**(10), 35–44.
- Darmani, N.A., McClanahan, B.A., Trinh, C., Petrosino, S., Valenti, M., and DiMarzo, V. (2005). Cisplatin increases brain 2-AG and anandamide levels in the least shrew. *Neuropharmacology* **49**(4), 502–513.
- Davis, A., Bunning, M., Gordy, P., Panella, N., Blitvich, B., and Bowen, R. (2005). Experimental and natural infection of North America bats with West Nile virus. *Am. J. Trop. Med. Hyg.* **73**(2), 467–469.
- Dearing, M.D., Skopec, M.M., and Bastianina, M.J. (2006). Detoxification rates of wild herbivorous woodrats (*Neotoma*). *Comp. Biochem. Physiol. A Mol. Integr. Physiol.* **145**(4), 419–422.
- DeStefani Marquez, D., Rodriguez-Ottaiano, C., Monica, R., Pedrosa, A.L., Cabrine-Santos, M., Lages-Silva, E., and Ramirez, L.E. (2006). Susceptibility of different triatomine species to *Trypanosoma rangeli* experimental infection. *Vector Borne Zoonotic Dis.* **6**(1), 50–56.
- Dewey, T., and Ballenger, L. (2002). *Ursus arctos* (On-line), University of Michigan Museum of Zoology Animal Diversity Web, <http://animaldiversity.ummz.umich.edu>

- Dhenain, M., Michot, J.-L., Volk, A., Picq, J.-L., and Boller, F. (1997). T2 weighted MRI studies of mouse lemurs: A primate model of brain aging. *Neurobiol. Aging* **18**, 517–521.
- Divers, B.J. (1986). “Zoo & Wild Animal Medicine.” (M.E. Fowler, ed.), 2nd ed., pp 621–630 (Edentates); pp 828–831 (Hyena). W.B. Saunders, Philadelphia.
- Donahue, S.W., Galley, S.A., Vaughan, M.R., Patterson-Buckendahl, P., Demers, L.M., Vance, J.L., and McGee, M.E. (2006a). Parathyroid hormone may maintain bone formation in hibernating black bears (*Ursus americanus*) to prevent disuse osteoporosis. *J. Exp. Biol.* **209**(Pt 9), 1630–1638.
- Donahue, S.W., McGee, M.E., Harvey, K.B., and Vaughan, M.R. (2006b). Hibernating bears as a model for preventing disuse osteoporosis. *J. Biochem.* **39**(8), 1480–1488.
- Donahue, S.W., Vaughan, M.R., Demers, L.M., and Donahue, H.J. (2003). Bone formation is not impaired by hibernation (disuse) in black bears *Ursus americanus*. *J. Exp. Biol.* **206**(Pt 23), 4233–4239.
- Domelly, T.M., and Quimby, F.W. (2002). “Laboratory Animal Medicine.” (J.G. Fox, L.C. Anderson, F.M. Loew, and F.W. Quimby, eds.), 2nd ed., pp 247–307. Academic Press, San Diego.
- Duan, W., Richardson, S.J., Babon, J.J., Heyes, R.J., Southwell, B.R., Harms, P.J., Wettenhall, R.E., Dziegielewska, K.M., Selwood, L., and Bradley, A.J. (1995). Evolution of transthyretin in marsupials. *Eur. J. Biochem.* **227**(1–2), 396–406.
- Dubey, J.P., Saville, W.J., Lindsay, D.S., Stich, R.W., Stanek, J.F., Speert, C.A., Rosenthal, B.M., Njoku, C.J., Kwok, C.J., Shen, S.K., and Reed, S.M. (2000). Completion of the life cycle of *Sarcocystis neurona*. *J. Parasitol.* **86**(6), 1276–1280.
- Edmonds, K.E., Riggs, L., and Stetson, M.H. (2003). Food availability and photoperiod affect reproductive development and maintenance in the marsh rice rat (*Oryzomys palustris*). *Physiol. Behav.* **78**(1), 41–149.
- Edmonds, K.E., and Stetson, M.H. (1995). Pineal gland and melatonin affect testicular status in the adult marsh rice rat (*Oryzomys palustris*). *Gen. Comp. Endocrinol.* **99**(3), 265–274.
- Endo, H., Yokokawa, K., Kurohmaru, M., and Hayashi, Y. (1998). Functional anatomy of gliding membrane muscles in the sugar glider (*Petaurus breviceps*). *Ann. Anat.* **180**(1), 93–96.
- Ewel, K.C. (1972). Patterns of change in the reproductive organs of the male pocket gopher *Geomys pinetus*. *J. Reprod. Fertil.* **30**(1), 1–6.
- Farley, S.D., and Robbins, C.T. (1995). Lactation, hibernation, and mass dynamics of America black bears. *Can. J. Zool.* **73**, 2216–2222.
- Ferry, A., and Olson, L. (2005). *Suncus etruscus* (On-line), University of Michigan Museum of Zoology Animal Diversity Web, <http://animaldiversity.ummz.umich.edu>
- Fine, J., and Quimby, F.W. (1986). Greenhouse D.D. Annotated Bibliography on Uncommonly Used Laboratory Animals: Mammals. *ILAR News*, **XXIX**(4), 4–10.
- Fischer, M.S., Schilling, N., Schmidt, M., Haarhaus, D., and Witte, H. (2002). Basic limb kinematics of small therian mammals. *J. Exp. Biol.* **205**(Pt 9), 315–338.
- Fitzgerald, S.D., Zwick, L.S., Diegel, K.L., Berry, D.E., Church, S.V., Sikarske, J.G., Kaneene, J.B., and Reed, W.M. (2003). Experimental aerosol inoculation of *Mycobacterium bovis* in North America opossums (*Didelphis virginiana*). *J. Wildl. Dis.* **39**(2), 418–423.
- Fons, R., Sender, S., Peters, T., and Jurgens, K.D. (1997). Rates of rewarming, heart and respiratory rates and their significance for oxygen transport during arousal from torpor in the smallest mammal the Etruscan shrew *Suncus etruscus*. *J. Exp. Biol.* **200**(Pt 10), 1451–1458.
- Fournier-Chambrillon, C., Vogel, I., Fournier, P., de Thoisy, B., and Vie, J.C. (2000). Immobilization of free-ranging nine-banded and great long-nosed armadillos with three anesthetic combination. *J. Wildl. Dis.* **36**(1), 131–140.
- Fox, D. (1999a). *Cryptotis parva* (On-line), University of Michigan Museum of Zoology Animal Diversity Web, <http://animaldiversity.ummz.umich.edu>
- Fox, D. (1999b). *Dasyypus novemcinctus* (On-line), University of Michigan Museum of Zoology Animal Diversity Web, <http://animaldiversity.ummz.umich.edu>
- Frappell, P.B., Boggs, D.F., and Kilgore, D.L. (1998). How stiff is the armadillo? Comparison with the allometrics of mammalian respiratory mechanics. *Respir. Physiol.* **113**(2), 111–122.
- Fulhorst, C.F., Ksiazek, T.G., Peters, T.G., and Tesh, R.B. (1999). Experimental infection of the cane mouse *Zygodontomys brevicauda* (family Muridae) with guaranito virus (Arenaviridae) the etiologic agent of Venezuelan hemorrhagic fever. *J. Infect. Dis.* **180**(4), 966–969.
- Gillespie, D. (1993). “Zoo and Wild Animal Medicine Current Therapy 3.” (M.E. Fowler, ed.), pp 304–321. W.B. Saunders, Philadelphia.
- Gillespie, D. (2003). “Zoo and Wild Animal Medicine and Surgery.” (M.E. Fowler and R.E. Miller, eds.), 5th ed., pp 397–407.
- Glickman, S.E., Cunha, G.R., Drea, C.M., Conley, A.J., and Place, N.J. (2006). Mammalian sexual differentiation: Lessons from the spotted hyena. *Trends Endocrinol. Metab.* **17**(9), 349–356.
- Goldstein, D.L., and Newland, S. (2004). Water balance and kidney function in the least shrew (*Cryptotis parva*). *Comp. Biochem. Physiol. A Mol. Integr. Physiol.* **139**(1), 71–76.
- Gos, T., Becker, K., Bock, J., Malecki, U., Bogerts, B., Poeggel, G., and Barun, K. (2006). Early neonatal and potweaning social emotional deprivation interferes with the maturation of serotonergic and tyrosine hydroxylase-immunoreactive afferent fiber systems in the rodent nucleus accumbens, hippocampus and amygdale. *Neuroscience* **140**(3), 811–821.
- Grippio, A.J., Lamb, D.G., Carter, C.S., and Porges, S.W. (2007). Cardiac regulation in the socially monogamous prairie vole. *Physiol. Behav.* Nov 13 (ahead of print). **90**(2–3): 386–93.
- Harlow, H.J., and Braun, E.J. (1995). Kidney structure and function of obligate and facultative hibernators: The white-tailed prairie dog (*Cynomys leucurus*) and the black-tailed prairie dog (*Cynomys ludovicianus*). *J. Comp. Physiol.* **165**(4), 320–328.
- Hayes, U.L., and De Vries, G.J. (2007). Role of pregnancy and parturition in induction of maternal behavior in prairie voles (*Microtus ochrogaster*). *Horm. Behav.* Dec 15 (ahead of print). **51**(2), 265–272.
- Heard, D.J. (2003). “Zoo and Wild Animal Medicine.” (M.E. Fowler and R.E. Miller, eds.), 5th ed., pp 315–333. W.B. Saunders, St. Louis.
- Heffner, R.S., and Heffner, H.E. (1990). Vestigial hearing in a fossorial mammal, the pocket gopher (*Geomys bursarius*). *Hear. Res.* **46**(3), 239–252.
- Helfrich, I., Chen, M., Schmidt, R., Furstenberger, G., Kopp-Schneider, A., Trick, D., Grone, H.J., Zur Hausen, H., and Rosl, F. (2004). Increased incidence of squamous cell carcinoma in *Mastomys natalensis* papillomavirus E6 transgenic mice during two-stage skin carcinogenesis. *J. Virol.* **78**(9), 4797–4805.
- Henke, J., Baumgartner, C., Roltgen, I., Eberspacher, E., and Erhardt, W. (2004). Anaesthesia with midazolam/medetomidine/fentanyl in chinchillas (*Chinchilla laniger*) compared to anaesthesia with xylazine/ketamine and medetomidine/ketamine. *J. Vet. Med. A. Physiol. Clin. Med.* **51**(5), 259–264.
- Hernandez-Divers, S.M. (2004). “Veterinary Clinics of North America, Exotic Animal Medicine, Wound Healing and Management,” pp 1–18. W.B. Saunders, Philadelphia.
- Hilderbrand, G.V., Schwartz, C.C., Robbins, C.T., and Hanley, T.A. (2000). Effect of hibernation and reproductive status on body mass and condition of coastal brown bears. *J. Wildl. Mgt.* **64**, 178–183.
- Holloway, J.C., and Geiser, F. (2001a). Effects of helium/oxygen and temperature on aerobic metabolism in the marsupial sugar glider, *Petaurus breviceps*. *Physiol. Biochem. Zool.* **74**(2), 219–225.
- Holloway, J.C., and Geiser, F. (2001b) Seasonal changes in the thermoenergetics of the marsupial sugar glider, *Petaurus breviceps*. *J. Comp. Physiol. [B]* **17**(8), 643–650.
- Holt, J., Davis, S., and Leirs, H. (2006). A model of leptospirosis infection in an African rodent to determine risk to humans: Seasonal fluctuations and the impact of rodent control. *Acta Trop.* **99**(2–3), 218–225.

- Holz, P. (2003). "Zoo and Wild Animal Medicine." (M.E. Fowler and R.E. Miller, eds.), 5th ed., pp 288–303. W.B. Saunders, St. Louis.
- Hurkova-Hoffmanova, L., Vaclavek, P., Skoric, M., Fictum, P., and Modry, D. (2007). Multimammate rat (*Mastomys natalensis*), Tristan's jird (*Meriones tristrami*) and wagner's gerbil (*Gerbillus dasyurus*) as laboratory models of acute neoplasia. *Res. Vet. Sci.* **82**(3), 377–381.
- Inestrosa, N.C., Reyes, A.E., Chacon, M.A., Cerpa, W., Villalon, A., Montiel, J., Meerabachvili, G., Aldunate, R., and Bozinovic, F. (2005). Human-like rodent amyloid-beta-peptide determines Alzheimer pathology in aged wild-type *Octodon degu*. *Neurobiol. Aging* **26**(7), 1023–1028.
- Isenbugel, E., and Baumgartner, R. (1993). "Zoo & Wild Animal Medicine Current Therapy 3." (M.E. Fowler, ed.), pp 294–302. W.B. Saunders, Philadelphia.
- Jansa, S. (1999). *Ochotona princeps* (On-line), University of Michigan Museum of Zoology Animal Diversity Web, <http://animaldiversity.ummz.umich.edu>.
- Job, C.K. (1991). Nine-banded armadillo (*Dasypus novemcinctus*) an animal model for leprosy. *Indian J. Lepr.* **63**(3–4), 356–361.
- Job, C.K., Sanchez, R.M., Hunt, R., Truman, R.W., and Hastings, R.C. (1993). Armadillos (*Dasypus novemcinctus*) as a model to test antileprosy vaccines; a preliminary report. *Int. J. Lepr. Other Mycobact. Dis.* **61**(3), 394–397.
- Johnson-Delaney, C.A. (2006). "Veterinary Clinics of North America, Exotic Animal Practice, Common Procedures." (C. Griffin, ed.), pp 415–435. W.B. Saunders, Philadelphia.
- Jones, I.H., Stoddard, D.M., and Mallick, J. (1995). Towards a sociobiological model of depression. A marsupial model (*Petaurus breviceps*). *Br. J. Psychiatry* **166**(4), 475–479.
- Jorns, A., Rath, K.J., Bock, O., and Lenzen, S. (2006). Beta cell death in hyperglycaemic *Psammomys obesus* is not cytokine-mediated. *Diabetologia* **49**(911), 2704–2712.
- Junge, R.E. (2003). "Zoo and Wild Animal Medicine." (M.E. Fowler and R.E. Miller, eds.), 5th ed., pp 334–346. W.B. Saunders, St. Louis.
- Junge, R.E., and Louis, E.E. (2005). Preliminary biomedical evaluation of wild ruffed lemurs (*Varecia variegata* and *V. rubra*). *Am. J. Primatol.* **66**, 85–94.
- Kaiser, N., Neshor, R., Donath, M.Y., Fraenkel, M., Behar, V., Magnan, C., Ktorza, A., Cerasi, E., and Leibowitz, G. (2005). *Psammomys obesus*, a model for environment-gene interactions in type 2 diabetes. *Diabetes* **54**(Suppl 2), S137–S144.
- Kaneko, T., Iida, H., Bedford, J.M., Oda, S., and Mori, T. (2003). Mating-induced cumulus—oocyte maturation in the shrew, *Suncus murinus*. *Reproduction* **126**(6), 817–826.
- Kiorpes, A.L., and Yuill, T.M. (1975). Environmental modification of western equine encephalomyelitis infection in the snowshoe hare (*Lepus americanus*). *Infect. Immunol.* **11**(5), 986–990.
- Klaphake, E. (2006). "Veterinary Clinics of North America, Exotic Animal practice, Common Procedures." (C. Griffin, ed.), pp 389–413. W.B. Saunders, Philadelphia.
- Koga, T., Takahashi, K., Sato, K., Kikuchi, I., Okazaki, Y., Miura, T., Katsua, M., and Narita, T. (2002). The effect of colonization by *Helicobacter pylori* in *Pracomys (Mastomys) natalensis* on the incidence of carcinoids. *J. Med. Microbiol.* **51**(9), 777–785.
- Korth, W.M. and Emry R.J. (1991). The skull of *Cedromus* and a review of the *Cedromurinae* (Rodentia, Sciuridae). *J. Paleontology* **65**, 984–994.
- Kraus, D.B., and Fadem, B.H. (1987). Reproduction, development and physiology of the gray short-tailed opossum (*Monodelphis domestica*). *Lab. Anim. Sci.* **37**(4), 478–482.
- Landesman, N. (1999). *Potorous tridactylus* (On-line), University of Michigan Museum of Zoology Animal Diversity Web, <http://animaldiversity.ummz.umich.edu>.
- Lau, A.H., Rudd, J.A., and Yew, D.T. (2005). Action of ondansetron and CP-99,994 on cisplatin-induced emesis and locomotor activity in *Suncus murinus* (house musk shrew). *Behav. Pharmacol.* **16**(8), 605–612.
- Lench, J., and Yahnke, C. (2004). *Suncus murinus* (On-line), University of Michigan Museum of Zoology Animal Diversity Web, <http://animaldiversity.ummz.umich.edu>.
- Liapis, H., Vogler, G., and Steinhardt, G.F. (1997). North American opossum *Didelphis virginiana* as a fetal nephrotoxicity model: Histologic and ultrastructural assessment of uranyl nitrate (UN)-induced damage. *Microsci. Res. Technol.* **39**(3), 285–296.
- Lundrigan, B., and Cisneros, L. (2005). *Tupaia glis* (On-line), University of Michigan Museum of Zoology Animal Diversity Web, <http://animaldiversity.ummz.umich.edu>.
- Lundrigan, B., and Gallego, M. (2005). *Bettongia gaimardi* (On-line), University of Michigan Museum of Zoology Animal Diversity Web, <http://animaldiversity.ummz.umich.edu>.
- Madarame, H., Kumagai, M., Suzuki, J., Watanabe, A., and Konno, S. (1990). Pathology of excessive iron storage in the Afghan pika (*Ochotona rufescens rufescens*). *J. Comp. Path.* **103**(3), 351–359.
- Magnanaou, E., Fons, R., Blondel, J., and Morand, S. (2005). Energy expenditure in *Crocidurinae* shrews (Insectivora): Is metabolism a key component of the insular syndrome? *Comp. Biochem. Physiol. A Mol. Integr. Physiol.* **142**(3), 276–285.
- Maislos, M., Medvedovsk, V., Sztarkier, I., Yaari, A., and Sikuler, E. (2006). *Psammomys obesus* (sand rat), a new animal model of non-alcoholic fatty liver disease. *Diabetes Res. Clin. Pract.* **72**(1), 1–5.
- Marston, J.H., Rand, G., and Chang, M.C. (1965). The care, handling and anesthesia of the snowshoe hare (*Lepus americanus*). *Lab. Anim. Care* **15**(5), 325–328.
- Martin, L.B., Glasper, E.R., Nelson, R.J., and Devries, A.C. (2006). Prolonged separation delays wound healing in monogamous California mice, *Peromyscus californicus*, but not in polygynous white-footed mice, *P. leucopus*. *Physiol. Behav.* **87**(5), 837–841.
- McFadden, D., Pasanen, E.G., Weldele, M.L., Glickman, S.E., and Place, N.J. (2006). Masculinized otoacoustic emissions in female spotted hyenas (*Crocuta crocuta*). *Horm. Behav.* **50**(2), 285–292.
- McKenzie, E.J., Jackson, M., Turner, A., Gregorash, L., and Harapiak, L. (2006). Chronic care and monitoring of woodchucks (*Marmota monax*) during repeated magnetic resonance imaging of the liver. *J. Am. Assoc. Lab. Anim. Sci.* **45**(2), 26–30.
- Measures, L.N., and Anderson, R.C. (1983). Development of the stomach worm, *Obeliscooides cuniculi* (Graybill) in lagomorphs, woodchucks, and small rodents. *J. Wildl. Dis.* **19**(3), 225–233.
- Meyer, G. (2000). *Trichosurus vulpecula* (On-line), University of Michigan Museum of Zoology Animal Diversity Web, <http://animaldiversity.ummz.umich.edu>.
- Mikita, K. (1999). *Sylvilagus floridanus* (On-line), University of Michigan Museum of Zoology Animal Diversity Web, <http://animaldiversity.ummz.umich.edu>.
- Miller, L.G., and Neiland, K.A. (1980). Experimental infections by *Brucella suis* type 4 in Alaska rodents. *J. Wildl. Dis.* **16**(4), 457–464.
- Miller, D.S., Sauter, M.L., Hunter-Ishikawa, M., Fish, K., Culbertson, H., Cuozzo, F.P., Campbell, T.W., Andrews, G.A., Chavey, P.S., Nachreiner, R., Rumbeiha, W., Stacewicz-Sapuntzakis, M., and Lappin, M.R. (2007). Biomedical evaluation of free-ranging ring-tailed lemurs (*Lemur catta*) in three habitats at the Beza Mahafaly special reserve, Madagascar. *J. Zoo Wildl. Med.* **38**(2) 201–216.
- Mock, O.B., Casteel, S.W., Darmani, N.A., Shaddy, J.H., Besch-Williford, C., and Towns, C.L. (2005). 1,3-Dinitrobenzene toxicity in the least shrew, *Cryptotis parva*. *Environ. Toxicol. Chem.* **24**(10), 2519–2525.
- Moore, D., and Myers, P. (2006). *Monodelphis domestica* (On-line), University of Michigan Museum of Zoology Animal Diversity Web, <http://animaldiversity.ummz.umich.edu>.
- Najdzion J., Wasilewska, B., Szkeyn, S., Robak, A., Bogus-Nowakowska, K., and Rowiak, M. (2006). The neuronal structure of the dorsal nucleus of the lateral geniculate body in the common shrew (*Sorex araneus*) and the bank vole (*Clethrionomys glareolus*); Golgi and Nissl studies. *Folia Morphol.* **65**(4), 352–358.

- Nelson, O.L., McEwen, M.M., Robbins, C.T., Felicetti, L.A., and Christensen, W.F. (2003). Cardiac function in active and hibernating grizzly bears. *J. Am. Vet. Med. Assoc.* **223**, 1170–1175.
- Neves-Ferreira, A.G., Cardinale, N., Rocha, S.L., Perales, J., and Domont, G.B. (2000). Isolation and characterization of DM40 and DM 43, two snake venom metalloproteinase inhibitors from *Didelphis marsupialis* serum. *Biochem. Biophys. Acta* **1474**(3), 309–320.
- Newell, T.L., and Berg, R. (2003). *Didelphis virginiana* (On-line), University of Michigan Museum of Zoology Animal Diversity Web, <http://animaldiversity.ummz.umich.edu>
- Nicol, S.C. (1978). Nonshivering thermogenesis in the potoroo *Potorous tridactylus*. *Comp. Biochem. Physiol.* **59C**, 33–37.
- Nicol, S.C., and Maskrey, M. (1977). Panting in small mammals; a comparison of two marsupials and the laboratory rabbit. *J. Appl. Physiol.* **42**(4), 537–544.
- Ntshotsho, P., van Aarde, R.J., Nicolson, S.W., and Jackson, P.T. (2004). Renal physiology of two southern Africa *Mastomys* species (Rodentia: Muridae): A salt-loading experiment to assess concentrating ability. *Comp. Biochem. Physiol. A Mol. Integr. Physiol.* **139**(4), 441–447.
- Ochocinska, D., and Taylor, J.R. (2005). Living at the physiological limits: Field and maximum metabolic rates of the common shrew (*Sorex araneus*). *Physiol. Biochem. Zool.* **78**(5), 808–818.
- Ohl, F., Michaelis, T., and Fujimori, H. (1999). Volumetric MRI measurements of the tree shrew hippocampus. *J. Neurosci. Methods* **88**(2), 189–193.
- Okamoto, M., Kamiya, M., Oku, Y., Ohbayashi, M., and Matsuzaki, T. (1990). Low susceptibility of the laboratory-reared Afghan pika, *Ochotona rufescens*, to *Haemonchus contortus*. *Nippon Juigaku Zasshi* **52**(5), 1107–1108.
- Olson, M.E., and McCabe, K. (1986). Anesthesia in the Richardson's ground squirrel: Comparison of ketamine, ketamine and xylazine, droperidol and fentanyl, and sodium pentobarbital. *J. Am. Vet. Med. Assoc.* **189**(9), 1035–1037.
- O'Neill, W.E. (1985). Responses to pure tones and linear FM compounds of the CF-FM biosonar signal by single units in the inferior colliculus of the mustached bat. *J. Comp. Physiol.* **157**(6), 797–815.
- O'Rourke, R.W., Seltman, A.K., Chang, E.Y., Reavis, K.M., Diggs, B.S., Hunter, J.G., and Jobe, B.A. (2006). A model for gastric banding in the treatment of morbid obesity: The effect of chronic partial gastric outlet obstruction on esophageal physiology. *Ann. Surg.* **244**(5), 723–733.
- Otolini, M.G., Bianco, J.C., Eichelberger, M.C., Porter, D.D., Pietneva, L., Richardson, J.Y., and Prince, G.A. (2005). The cotton rat provides a useful small-animal model for the study of influenza virus pathogenesis. *J. Gen. Virol.* **86**(Pt 10), 2823–2830.
- Ovtscharoff, W., Helmeke, C., and Braun, K. (2006). Lack of paternal care affects synaptic development in the anterior cingulate cortex. *Brain Res.* **1116**(1), 58–63.
- Padovan, D. (1985). Intraperitoneal pentobarbitone anaesthesia of *Mystromys albicaudatus*. *Lab. Anim.* **19**(1), 16–18.
- Passata, J. (1999). *Petaurus breviceps* (On-line), University of Michigan Museum of Zoology Animal Diversity Web, <http://animaldiversity.ummz.umich.edu>
- Peichl, L., Kunzle, H., and Vogel, P. (2000). Photoreceptor types and distributions in the retinae of insectivores. *Visc. Neurosci.* **17**(6), 937–948.
- Peters, T., Kubis, H.P., Wetzels, P., Sender, S., Asmussen, G., Fons, R., and Jurgens, K.D. (1999). Contraction parameters, myosin composition and metabolic enzymes of the skeletal muscles of the Etruscan shrew *Suncus etruscus* and of the common European white-toothed shrew *Crocidura russula* (Insectivora: Soricidae). *J. Exp. Biol.* **202**(Pt 18), 2461–2473.
- Pollock, C. (2002). “The Veterinary Clinics of North America, Exotic Animal Practice, Orthopedics.” (T.N. Tully, ed.), pp 183–212. W.B. Saunders, Philadelphia.
- Preston, S.D., and Jacobs, L.F. (2005). Cache decision making: The effects of competition on cache decisions in Merriam's kangaroo rat (*Dipodomys merriami*). *J. Comp. Psychol.* **119**(2), 187–196.
- Pye, G.W. (2001). “The Veterinary Clinics of North America, Exotic Animal Practice, Anesthesia and Analgesia.” (D.J. Heard, ed.), pp 211–228. W.B. Saunders, Philadelphia.
- Ramsay, E.C. (2003). “Zoo and Wild Animal Medicine.” (M.E. Fowler and R.E. Miller, eds.), 5th ed., pp 523–538. W.B. Saunders, St. Louis.
- Remple, M.S., Reed, J.L., Stepniwska, I., and Kaas, J.H. (2006). Organization of frontoparietal cortex in the tree shrew (*Tupaia belangeri*). I. Architecture, microelectrode maps, and corticospinal connections. *J. Comp. Neurol.* **497**(1), 133–154.
- Rizvanov, A.A., Khaiboullina, S.F., van Geelen, A.G., and St. Jeor, S.C. (2006). Replication and immunoactivity of the recombinant *Peromyscus maniculatus* cytomegalovirus expressing hantavirus G1 glycoprotein in vivo and in vitro. *Vaccine* **24**(3), 327–334.
- Robinson, E.S., and Van de Berg, J.L. (1994). Blood collection and surgical procedures for the laboratory opossum (*Monodelphis domestica*). *Lab. Anim. Sci.* **44**(1), 63–68.
- Roebuck, B.D., and Longnecker, D.S. (1979). Response of two rodents, *Mastomys natalensis* and *Mystromys albicaudatus*, to the pancreatic carcinogen azaserine. *J. Natl. Cancer Inst.* **62**(5), 1269–1271.
- Rose, R.W., and Kuswanti, N. (2004). Thyroid function and the development of endothermy in a marsupial, the Tasmanian bettong, *Bettongia gaimardi*. *Gen. Comp. Endocrinol.* **136**(1), 17–22.
- Rose, R.W., and MacFayden, A.S. (1997). The role of prostaglandin F2 alpha and oxytocin in the reproductive behavior of a marsupial, *Bettongia gaimardi*. *Horm. Behav.* **31**(2), 120–125.
- Rose, R.W., West, A.K., Ye, J.M., McCormick, G.H., and Colquhoun, E.Q. (1999). Nonshivering thermogenesis in a marsupial (the Tasmanian bettong *Bettongia gaimardi*) is not attributable to brown adipose tissue. *Physiol. Biochem. Zool.* **72**(6), 699–704.
- Ryan, A.T., Hale, B., Megirian, D., and Sherrey, J.H. (1983). The effects of hypoxia and CO₂ on the sleep-waking pattern of the potoroo (*Potorous tridactylus apicalis*). *Physiol. Behav.* **35**(2), 237–242.
- Sainsbury, A.W. (2003). “Zoo and Wild Animal Medicine.” (M.E. Fowler and R.E. Miller, eds.), 5th ed., pp 420–442. W.B. Saunders, St. Louis.
- Santos-Argumedo, L., Guerra-Infante, F., Posada-Lopez, A., Quesada-Pascual, F., and Estrada-Parra, S. (1995). Immune response of armadillos (*Dasypus novemcinctus*). I. Use of lectins to identify lymphocyte subpopulations and to evaluate cell proliferation. *Int. J. Lepr. Other Mycobact. Dis.* **63**(4), 546–551.
- Satoh, K., and Iwaku, F. (2006). Jaw muscle functional anatomy in northern grasshopper mouse, *Onychomys leucogaster*, a carnivorous murid. *J. Morphol.* **267**(8), 987–999.
- Schaeffer, P.J., Villarin, J.J., Pierotti, D.J., and Lindstedt, S.L. (2005). Cost of transport is increased after cold exposure in *Monodelphis domestica*: Training for inefficiency. *J. Exp. Biol.* **208**(Pt 16), 3159–3167.
- Schobert, E. (1987). Telazol use in wild and exotic animals. *Vet. Med.* **1080**–1088.
- Schwaier, A. (1979). Tupaia (tree shrews)—a new animal model for gallstone research; first observation of gallstones. *Res. Exp. Med.* **176**(1), 15–24.
- Shafir, E., Ziv, E., and Kalman, R. (2006). Nutritionally induced diabetes in desert rodents as models of type 2 diabetes: *Acomys cahirinus* (spiny mice) and *Psammomys obesus* (desert gerbil). *ILAR J.* **47**(3), 212–224.
- Shavlakadze, T., and Grounds, M. (2006). Of bears, frogs, mice and men: Complexity of factors affecting skeletal muscle mass and fat. *Bioessays* **28**(10), 994–1009.
- Shepherd, A.J., Leman, P.A., and Swanepoel, R. (1989). Viremia and antibody response of small African and laboratory animals to Crimean-Congo hemorrhagic fever virus infection. *Am. J. Trop. Med. Hyg.* **40**(5), 541–547.
- Sherwood, C.C., Raghanti, M.A., and Wenstrup, J.J. (2005). Is humanlike cytoarchitectural asymmetry present in another species with complex social vocalization? A stereologic analysis of mustached bat auditory cortex. *Brain Res.* **1045**(1–2), 164–174.
- Shima, A.L. (1999). “Zoo & Wild Animal Medicine.” (M.E. Fowler and R.E. Miller, eds.), 4th ed., pp 333–336. W.B. Saunders, Philadelphia.

- Siegwart, J.T., and Norton, T.T. (2005). Selective regulation of MMP and TIMP mRNA levels in tree shrew sclera during minus lens compensation and recovery. *Invest. Ophthalmol. Visc. Sci.* **46**(10), 3484–3482.
- Silverman, J., and Ingram, L. (1986). Ketamine and xylazine anesthesia of the deer mouse. *Lab. Anim. Sci.* **36**(5), 539–540.
- Smith, J.N., Pan, X., Gentles, A., Smith, E.E., Cox, S.B., and Cobb, G.P. (2006a). Reproductive effects of hexahydro-1,3,5-trinitrosos-1,3,5-triazine in deer mice (*Peromyscus maniculatus*) during a controlled exposure study. *Environ. Toxicol. Chem.* **25**(2), 446–451.
- Smith, M.C., Leatherland, J.F., and Myers, K. (1978). effects of seasonal availability of sodium and potassium on the adrenal cortical function of a wild population of snowshoe hares. *Lepus Americanus. Can. J. Zool.* **56**(8), 1869–1876.
- Smith, P.N., Severt, S.A., Jackson, J.W., Anderson, T.A. (2006b). Thyroid function and reproductive success in rodents exposed to perchlorate via food and water. *Environ. Toxicol. Chem.* **25**(4), 1050–1059.
- Spencer, A.M., Goethert, H.K., Telford, S.R., and Holman, P.J. (2006). In vitro host erythrocyte specificity and differential morphology of *Babesia divergens* and a zoonotic *Babesia* sp. from eastern cottontail rabbits (*Sylvilagus floridanus*). *J. Parasitol.* **92**, 333–340.
- Stolp, H.B., Dziegielewska, K.M., Elk, C.J., Habgood, M.D., Lane, M.A., Potter, A.M., and Saunders, N.R. (2005). Breakdown of the blood-brain barrier to proteins in white matter of the developing brain following systemic inflammation. *Cell Tissue Res.* **320**(3), 369–378.
- Suzuki, D., Murata, Y., and Oda, S. (2006). Change in Ucp1 mRNA expression following long-term cold exposure under normal or high-fat diet regimes in the cold-tolerant mammal, *Suncus murinus*. *Exp. Anim.* **55**(5), 467–471.
- Suzumoto, M., Hotomi, M., Fujihara, K., Tamura, S., Kuki, K., Tohya, K., Kimura, M., and Yamanak, N. (2006). Functions of tonsils in the mucosal immune system of the upper respiratory tract using a novel animal model, *Suncus murinus*. *Acta Otolaryngol.* **126**(11), 1164–1170.
- Takata, T., Matsuura, M., Murashima, M., Miyauchi, M., and Nikai, H. (1999). Periodontitis in the house musk shrew (*Suncus murinus*): A potential animal model for human periodontal disease. *J. Periodontol.* **70**(2), 195–200.
- Takeuchi, Y., Suzuki, D., Oda, S., Refetoff, S., Seki, K., Tsunekawa, K., Kasahar, T., Murakami, M., and Murata, Y. (2006). Unique regulation of thyroid hormone metabolism during fasting in the house musk shrew (*Suncus murinus*, Insectivora: Soricidae). *Gen. Comp. Endocrinol.* **146**(3), 236–241.
- Taylor, M. (2002). *Sorex araneus* (On-line), University of Michigan Museum of Zoology Animal Diversity Web, <http://animaldiversity.ummz.umich.edu>
- Temple, J.L. (2004). The musk shrew (*Suncus murinus*): A model species for studies of nutritional regulation of reproduction. *ILAR J.* **45**(1), 25–34.
- Tiawsirisup, S., Platt, K.B., Tucker, B.J., and Rowley, W.A. (2005). Eastern cottontail rabbits (*Sylvilagus floridanus*) develop West Nile virus viremia sufficient for infecting select mosquito species. *Vector Borne Zoonotic Dis.* **5**(4), 342–350.
- Trainor, B.C., Martin, L.B., Greiwe, K.M., Kuhlman, J.R., and Nelson, R.J. (2006). Social and photoperiod effects on reproduction in five species of Peromyscus. *Gen. Comp. Endocrinol.* **148**(2), 252–259.
- Tsiouris, J.A. (2005). Metabolic depression in hibernation and major depression: An explanatory theory and an animal model of depression. *Med. Hypotheses* **65**(5), 829–840.
- Tsuji, K., Ischii, K., Matsuo, T., and Kawano, K. (1999). The house musk shrew *Suncus murinus* as a new laboratory animal for use in behavioral studies. *Jpn. J. Anim. Psychol.* **49**, 1–18.
- Uchino, M., Kuwahara, M., Ebukuro, S., and Tsubone, H. (2006). Modulation of emetic response by carotid baro- and chemoreceptor activations. *Auton. Neurosci.* **128**(1–2), 25–36.
- Umminger, B.L., (1975) Body size and whole blood sugar concentrations in mammals. *Comp. Biochem. Physiol.* **52A**, 455–458.
- Vedtofte, L., Bodvarsdottir, T.B., Karlsen, A.E., and Heler, R.S. (2007). Developmental biology of the *Psammomys obesus* pancreas: Cloning and expression of the neurogenin-3 gene. *J. Histochem. Cytochem.* **55**(1), 97–104.
- Vinyard, C.J., Williams, S.H., Wall, C.E., Johnson, K.R., and Hylander, W.L. (2005). Jaw-muscle electromyography during chewing in Belanger's tree shrews (*Tupaia belangeri*). *Am. J. Phys. Anthropol.* **127**(1), 26–45.
- Waggie, K.S., Thornburg, L.P., and Wagner, J.E. (1986). Experimentally induced Tyzzer's disease in the African white-tailed rat (*Mystromys albicaudatus*). *Lab. Anim. Sci.* **36**(5), 492–495.
- Wallace, G.M., and Pfeiffer, E.W. (1992). The effects of dietary deprivation on body temperature and oxygen consumption in black-tailed prairie dogs (*Cynomys ludovicianus*). *Comp. Biochem. Physiol. Comp. Physiol.* **101**(4), 853–855.
- Wallach, J.D., and Boever, W.J. (1983). "Diseases of Exotic Animals, Medical and Surgical Management." Rodents and Lagamorphs, pp 135–195. Hyaenidae, pp 535–547. Ursidae, pp 549–573. Marsupialia, pp 575–611. Edentates, pp 613–629. Insectivora, pp 653–664. Chiroptera, pp 665–675. W.B. Saunders, Philadelphia.
- Wang, J.M., Zhang, Y.M., and Wang, D.H. (2006). Photoperiod regulation in energy intake, thermogenesis and body mass in root voles (*Microtus oeconomus*). *Comp. Biochem. Physiol. A Mol. Integr. Physiol.* **145**(4), 546–553.
- Wang, X.M., Terman, J.R., and Martin, G.F. (1999). Rescue of axotomized rubrospinal neurons by brain-derived neurotrophic factor (BDNF) in the developing opossum, *Didelphis virginiana*. *Brain Res. Dev. Brain Res.* **118**(1–2), 177–184.
- Weber, J.M., and O'Connor, T. (2000). Energy metabolism of the Virginia opossum during fasting and exercise. *J. Exp. Biol.* **203**(Pt 8), 1365–1371.
- Williams, C.V., Glenn, K.M., Levine, J.F., Horne, W.A. (2003). Comparison of the efficacy and cardiorespiratory effects of medetomidine-based anesthetic protocols in ring-tailed lemurs (*Lemur catta*). *J. Zoo Wildl. Med.* **34**(2), 163–170.
- Williams, J.V., Tollefson, S.J., Johnson, J.E., and Crowe, J.E. (2005). The cotton rat (*Sigmodon hispidus*) is a permissive small animal model of human metapneumovirus infection, pathogenesis, and protective immunity. *J. Virol.* **79**(17), 10944–10951.
- Witte, H., Biltzinger, J., Hackert, R., Schilling, N., Schmidt, M., Reich, C., and Fischer, M.S. (2002). Torque patterns of the limbs of small therian mammals during locomotion on flat ground. *J. Exp. Biol.* **205**(Pt 9), 1339–1353.
- Xiao, S.Y., Sbrana, E., Watts, D.M., Siirin, M., da Rosa, A.P., and Tesh, R.B. (2005). Experimental infection of prairie dogs with monkeypox virus. *Emerg. Infect. Dis.* **11**(4), 539–545.
- Yamamoto, R.S., Kroes, R., and Weisburger, J.H. (1972). Carcinogenicity of diethylnitrosamine in *Mystromys albicaudatus* (African white-tailed rat). *Proc. Soc. Exp. Biol. Med.* **140**(3), 890–892.
- Ye, J.M., Edwards, S.J., Rose, R.W., Rattigan, S., Clark, M.G., and Colquhoun, E.Q. (1995). Vasoconstrictors alter oxygen, lactate, and glycerol metabolism in the perfused hindlimb of a rat kangaroo. *Am. J. Physiol.* **268**(5 Pt 2), R1217–R1223.
- Yi, S.Q., Ru, F., Ohta, T., Terayama, H., Naito, M., Hayashi, S., Buhe, S., and Yi, N. (2006). Surgical anatomy of the innervation of pylorus in human and *Suncus murinus*, in relation to surgical technique for pylorus-preserving pancreaticoduodenectomy. *World J. Gastroenterol.* **12**(14), 2209–2216.
- Yim, K.C., Carroll, C.J., Tuyama, A., Cheshenko, N., Carlucci, M.J., Porter, D.D., Prince, G.A., and Herold, B.C. (2005). The cotton rat provides a novel model to study genital herpes infection and to evaluate preventive strategies. *J. Virol.* **79**(23), 14632–14639.
- Young, R.A., and Sims, E.A. (1979). The woodchuck, *Marmota monax*, as a laboratory animal. *Lab. Anim. Sci.* **29**(6), 770–780.
- Zhou, X., and Jen, P.H. (2006). Duration selectivity of bat inferior collicular neurons improves with increasing pulse repetition rate. *Clin. J. Physiol.* **49**(1), 46–55.

Anesthesia and Analgesia in Birds

John W. Ludders

I. Introduction	481
II. The Pulmonary System: Form, Function, and Implications for Anesthetic Management	483
A. Pulmonary System	483
B. Ventilation Component	483
C. Gas Exchange Component	486
D. Control of Ventilation	488
E. Cardiovascular System	488
III. Specific Considerations for Anesthesia	489
A. Physical Restraint and Examination	489
B. Fasting	489
C. Injectable Anesthetics	490
D. Inhalant Anesthetics	493
E. Breathing Circuits and Fresh Gas Flows	493
F. Induction Methods	493
G. Minimum Alveolar Concentration (MAC)	494
H. Halothane, Isoflurane, and Sevoflurane	494
I. Adjuncts to General Anesthesia	495
J. Monitoring	495
K. Recovery	496
IV. Euthanasia of Birds	496
V. Recommended Reading	497
References	497

I. INTRODUCTION

A prerequisite for effectively anesthetizing birds is an understanding of avian anatomy, physiology, and pharmacology. Of these, the avian pulmonary and cardiovascular systems are crucially important and tend to be the source of frequent problems

in the design and implementation of anesthetic protocols for research projects involving birds. For these reasons, much of this chapter will focus on these two systems.

Drugs will be discussed in general terms, but some specific drugs and doses used in specific avian species to produce specific effects will be discussed in some detail. This approach

TABLE 18-1
SELECTED DRUGS AND DOSES USED FOR ANESTHESIA OF BIRDS

Drug	Dose	Comment
Equithesin Chickens	2.5 ml/kg, IM ^a	Consists of: pentobarbital 9.6 g/L, chloral hydrate 42.6 g/L, and magnesium sulfate 21.2 g/L in propylene glycol, ethanol, and water to make 1 L. ^a Surgical anesthesia cannot be achieved with this drug when used alone
Pentobarbital Chickens	30 mg/kg, IV, IM ^b	Intravenous injections must be administered slowly. One-fourth to one-third of the total dose is administered initially over 2–3 minutes, the bird's response is assessed, and additional drug is administered slowly as needed
Turkey	26–30 mg/kg, IV ^b	
Herring gull	60–84 mg/kg, IM ^b	
Phenobarbital Chickens	130–170 mg/kg, IV, IM ^b	When given intravenously, slow administration is mandatory. One-fourth to one-third of the total dose is administered initially over 3–5 minutes, the effects are assessed, and additional drug is injected slowly as needed over 5–10 minutes to achieve the desired plane of anesthesia. In some birds, I have stopped injections for 10 minutes to allow the drug to reach a peak effect, and then given additional drug as needed over several minutes to achieve satisfactory anesthesia
Ducks	160 mg/kg, IV	
Propofol Chickens	4.5–9.7 mg/kg, IV ^c	Hypoventilation, hypoxemia, and cardiac arrhythmias occurred frequently Apnea was a common problem and did cause some deaths
Ducks (canvasback)	15 mg/kg, IV (loading dose) ^d 0.8 mg/kg, IV (infusion) ^d	
Ducks (mallard)	8.8 mg/kg, IV ^c	All ducks developed apnea after induction ^e Apnea at induction is common. Hypoxemia and hypercarbia developed over 15 minutes of anesthesia
Turkey (wild)	5 mg/kg, IV ^f	
Telazol [®] (combination of tiletamine and zolazepam) Ducks	13 mg/kg ^g	One death in 34 anesthetic episodes ^g
Lidocaine	1–2 mg/kg, IM, IV, SQ	Local anesthetics may be used in birds for local/regional anesthesia, but dosing limits must be strictly followed to avoid toxic levels and effects, especially in small birds. A lidocaine (2%) dose of 1 mg/kg, IM for a 30 g bird is a volume of 0.001 ml, which is impossible to administer accurately given syringes commonly available.

^aChristensen et al. (1987).

^bFedde (1978).

^cLukasik et al. (1997).

^dMachin and Caulkett (1998).

^eMachin and Caulkett (1999).

^fSchumacher et al. (1997).

^gCarp et al. (1991).

to drugs may pose a dilemma for some investigators. If a researcher is using pigeons in eye research, he or she may question the applicability of information concerning the production of mydriasis in double-crested cormorants or blue-fronted amazons to pigeons. However, studies of pigeons that deal with this specific topic, for example, do not exist, so what is presented are data that are based on good studies regardless of the species involved. This information is a starting point for a researcher who uses birds in research and who will have to extrapolate the information to the species he or she is working with while also using good professional judgment. For a compendium of drugs and doses useful for anesthetic management of avian species, the reader is referred to the list of suggested readings at the

end of this chapter and to Table 18-1. In addition, some general comments and suggestions regarding the selection of drugs for selected types of research studies are included in Table 18-2. I must be honest with the reader and state here at the outset that I have a bias in favor of using inhalant anesthetics in birds, specifically the use of isoflurane. My reasons for this are discussed in detail throughout this chapter, some of them being that inhalants, specifically isoflurane, are among the safest if not the safest anesthetics for birds; they make it possible to control the depth of anesthesia to a degree that is not possible with injectable drugs, and isoflurane, in my opinion and experience, provides a degree of cardiac stability and safety not seen with other anesthetics.

TABLE 18-2

SOME GENERAL COMMENTS AND SUGGESTIONS REGARDING THE SELECTION OF DRUGS FOR SELECTED TYPES OF RESEARCH STUDIES

Type of study	Comments
Respiratory system	If the objective is to preserve respiratory control mechanisms, <i>phenobarbital</i> is a reasonable choice for general anesthesia, keeping in mind that the drug has little, if any, analgesic properties. If a bird is to be recovered from anesthesia, recovery will be prolonged (up to 24 hours), and the investigator must provide analgesia. In my opinion, it is more humane to euthanize a bird at the end of a study session if a long-acting barbiturate is used so as to avoid complications that often arise during prolonged, stormy recoveries
Cardiovascular system	The inhalant <i>isoflurane</i> may be used, but the potential for cardiac arrhythmias developing is still possible, especially if PaCO ₂ is >50 torr. <i>Equithesin</i> , in combination with diazepam, has been used to anesthetize birds undergoing thoracotomy
Hepatic	<i>Isoflurane</i> is a reasonable anesthetic for these types of studies because it is minimally metabolized compared to sevoflurane and especially halothane. To avoid any question of effects on hepatic function, injectable anesthetics, even the short-acting propofol, cannot be recommended, because their elimination requires some degree of hepatic metabolism/physiology which may affect the results of research. However, <i>Telazol</i> [®] has been used for anesthesia of ducks undergoing multiple liver biopsies seemingly without adverse effects on the biopsy results (Carp et al., 1991)
Renal	Anesthetic drugs devoid of renal effects may be used and include the inhalant <i>isoflurane</i> and injectable anesthetics such as <i>phenobarbital</i> or <i>equithesin</i> . Sevoflurane produces compound A as a result of interaction with dry carbon dioxide absorbent, and this compound may affect renal function. This may not be an issue when using a nonbreathing circuit
Field studies	<i>Propofol</i> has been recommended as a drug that may be useful in field studies because it provides rapid induction to and recovery from anesthesia. A study involving ducks anesthetized for insertion of intra-abdominal transmitters (Machin and Caulkett, 2000) demonstrated that propofol, compared to isoflurane, was less likely to cause nest abandonment. <i>Isoflurane</i> delivered by metering oxygen from an E cylinder through a free-standing vaporizer to a nonbreathing circuit has been used in field situations

Source: Carp et al. (1991), Machin and Caulkett (2000).

II. THE PULMONARY SYSTEM: FORM, FUNCTION, AND IMPLICATIONS FOR ANESTHETIC MANAGEMENT

A. Pulmonary System

The avian respiratory system consists of two separate and distinct functional components: a component for ventilation (conducting airways, air sacs, thoracic skeleton, and muscles of respiration), and a component for gas exchange (parabronchial lung) (Ludders and Matthews, 1996). These two components, which do not exist in mammals, can be used to advantage when anesthetizing birds, specifically when using inhalant anesthetics such as halothane, isoflurane, or sevoflurane.

B. Ventilation Component

1. Larynx, Trachea, and Syrinx

The avian larynx, located at the base of the tongue, protrudes into the pharynx as a somewhat heart-shaped mound (McLelland, 1989a). Unlike in mammals, birds do not have an epiglottis and when the tongue is pulled gently forward out of the mouth, the larynx is easily visualized in most birds (Fig. 18-1).

In all avian species, the tracheal cartilages form complete rings (McLelland, 1989a), but there are significant species-related variations in tracheal anatomy. For example, the emu and ruddy duck have an inflatable sac-like diverticulum (tracheal sac) that opens from the trachea (McLelland, 1989a). Some penguins and petrels have a median tracheal septum that extends cranially from the tracheal bifurcation and divides the trachea into right and left channels, for a variable length depending on the species (McLelland, 1989a). Depending on the species, some birds have complex tracheal loops or coils that may be located in the caudal neck, within the keel, or within the thorax and the keel.

The fact that birds generally have relatively long necks and trachea, not to mention tracheal loops and coils, has important implications for tracheal dead space, an important consideration during general anesthesia. The typical bird trachea is 2.7 times longer than that of a comparably sized mammal, but it is 1.29 times wider, the net result being that the resistance to flow imposed by the longer trachea is minimized (Brown et al., 1997; McLelland, 1989a). Tracheal dead space volume is increased in birds to about 4.5 times that of comparably sized mammals, but their relatively low respiratory frequency, approximately one-third that of mammals, ensures that the effect of the larger tracheal dead space volume on measures

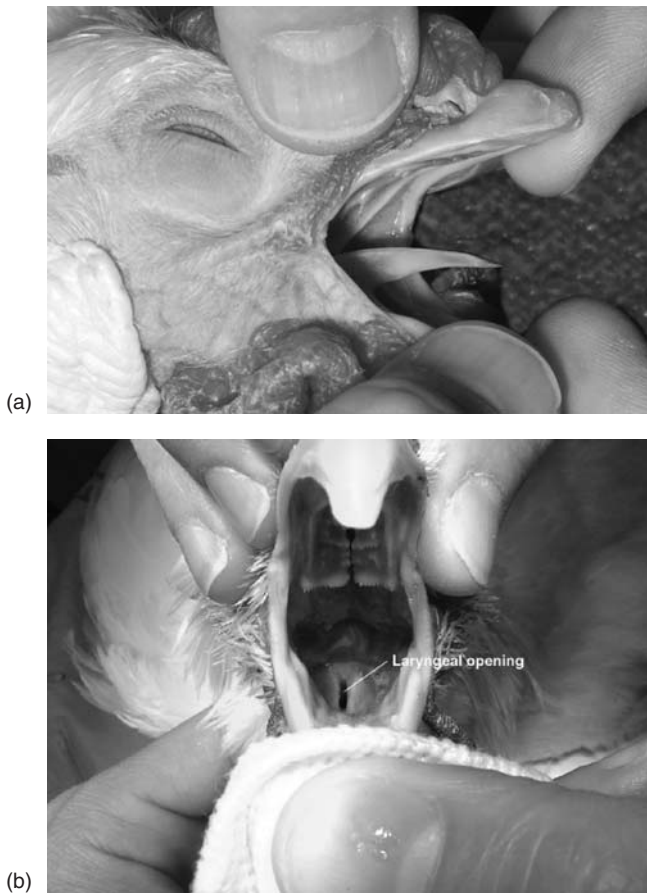

Fig. 18-1 (a) Tongue and larynx. Once a bird is induced to anesthesia, light pressure applied to the intermandibular space elevates the tongue so that it can be gently grasped and pulled forward to aid in visualizing the larynx. (b) Larynx. By gently pulling out the tongue, the larynx is brought into view and makes intubation easier.

of ventilation is decreased (McLelland, 1989a). As a result, minute tracheal ventilation is only about 1.5 to 1.9 times that of mammals (McLelland, 1989a).

The syrinx, the sound-producing organ in birds, is located at the junction of the trachea and the mainstem bronchi. Its shape, size, and location are extremely variable among avian species, but its location explains why gas flowing through the trachea of an anesthetized, intubated bird, especially during positive pressure ventilation, can produce sound.

2. Bronchi

Unlike the mammalian lung, which has 23 orders of branching of the bronchial system before reaching the gas exchange area, birds have only 3 orders of branching of the bronchial system before reaching the gas exchange tissues (Brown et al., 1997). The avian bronchial system consists of a primary bronchus (extrapulmonary and intrapulmonary), secondary bronchi, and tertiary bronchi (parabronchi), the last of which, along with the para-peribronchial mantle of tissue, forms the gas

exchange tissues of the lung (Brown et al., 1997; McLelland, 1989b).

The primary bronchus enters the lung ventrally and obliquely at the junction of the cranial and middle thirds of the lung, and then passes dorsolaterally to the lung surface, where it turns caudally in a dorsally curved course until at the caudal lung margin it opens into the abdominal air sac. (Duncker, 1972). A secondary bronchus is any bronchus that arises from a primary bronchus. Many of the medioventral and lateroventral secondary bronchi open into the cervical, clavicular, cranial thoracic, or abdominal air sacs.

3. Air Sacs

Birds have nine air sacs: two cervical, an unpaired clavicular, two cranial thoracic, two caudal thoracic, and two abdominal air sacs. The air sacs are thin-walled structures composed of simple squamous epithelium covering a thin layer of connective tissue with very few blood vessels (McLelland, 1989b). To a varying extent, depending upon the species, diverticula from air sacs aerate cervical vertebrae, some of the thoracic vertebrae, vertebral ribs, sternum, humerus, pelvis, and head and body of the femur (McLelland, 1989b). From a functional point of view, the air sacs may be thought of as bellows to the lungs because they provide a tidal flow of air to the relatively rigid avian lung (Scheid, 1979). Based on their bronchial connections, air sacs are grouped into a cranial group consisting of the cervical, clavicular, and cranial thoracic air sacs, and a caudal group consisting of the caudal thoracic and abdominal air sacs (Fedde, 1980). The volume of the air sacs is distributed approximately equally between the cranial and caudal groups (Scheid and Piiper, 1989a). During ventilation, all air sacs are effectively ventilated, with the possible exception of the cervical air sacs, and the ratio of ventilation to volume is similar for each air sac (Scheid and Piiper, 1989a).

In birds, unlike in mammals, both inspiration and expiration are active processes that require muscular activity. With contraction of the inspiratory muscles, the internal volume of the thoracoabdominal cavity increases and, since the air sacs are the only volume-compliant structures within the body cavity, volume changes occur mainly in the air sacs (Scheid and Piiper, 1989a). During inspiration, pressure within the air sacs becomes negative relative to ambient atmospheric pressure, and air flows from the atmosphere into the air sacs and across the gas exchange surfaces of the lungs.

Because air sacs are vessel-poor, they neither participate in gas exchange (Magnussen et al., 1976) nor play a major role in the uptake of inhalant anesthetics. Nor, as has been suggested (Christensen et al., 1987), do air sacs accumulate or concentrate anesthetic gases. Indeed, in a study of anesthetized, spontaneously breathing pigeons, it was found that the concentration of isoflurane in the abdominal air sacs was always lower than the concentration measured at the end of the endotracheal tube (Hellebrekers et al., 1991).

4. Ventilation Components and Considerations for Anesthesia

Any bird larger than a cockatiel or heavier than 100 g can be intubated (Klide, 1973), but one must keep in mind the unique tracheal features, as outlined above, that may interfere with intubation. Most birds are easy to intubate, but some are difficult because of either their unique oropharyngeal anatomy or their size. For example, psittacine species, especially smaller birds such as parakeets, can be difficult to intubate because of the awkward location of the glottis at the base of the humped, fleshy tongue (Sedgwick, 1980). Small birds such as chicks (*Gallus* sp.) can be intubated, but their size limits the size of commercially available endotracheal tube that can be used for intubation. As a result, investigators may resort to using intravenous (IV) catheters as endotracheal tubes (Fig. 18-2; Roberson et al., 2000). This can be an effective means for intubating and delivering inhalant anesthetics to small birds, but the design features of IV catheters and their potential for harm to the avian trachea must be considered. Compared to commercially available endotracheal tubes which possess some degree of flexibility and thermoplasticity, IV catheters are relatively stiff and their tips are relatively sharp. For these reasons, IV catheters may cause tracheal trauma (abrasion or puncture) if they are not inserted carefully into the trachea. Furthermore, a catheter of appropriate circumference must be selected so that there is some degree of gas leak around itself (Roberson et al., 2000). If the catheter completely fills the trachea, volotrauma may occur to the air sacs and possibly barotrauma to the lungs.

There are significant risks associated with intubation, especially in small birds. Tubes with small internal diameters

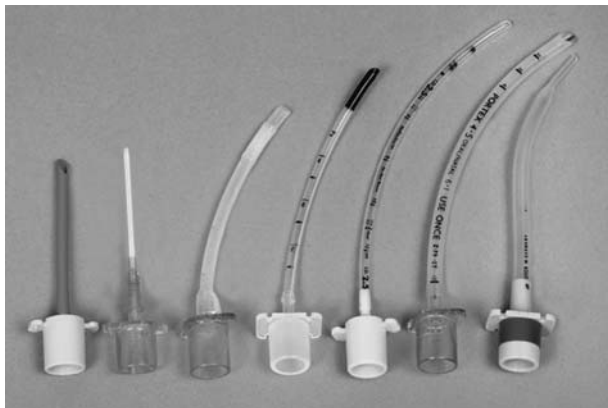

Fig. 18-2 Endotracheal tubes used for intubating birds. From left to right: red rubber tube cut so that it has a beveled tip; note the rough edges and points at the end of the tube, all of which may damage the tracheal mucosa. A 14-gauge 1.75 inch catheter on an endotracheal tube connector. A cuffed endotracheal tube made of silicone. The next three endotracheal tubes are made of polyvinyl chloride; although not clearly visible, the last two of the three have a Murphy eye, a desirable design feature in any endotracheal tube. Cole tube (last tube on right); note the shoulder, the point at which the tube narrows; the narrow end of the tube is inserted into the trachea and the shoulder rests against the larynx.

can impose significant resistance to ventilation, a feature that becomes an even greater hazard when such tubes develop partial or complete obstructions, an all too frequent occurrence as a result of the accumulation of mucus and the development of mucus plugs. Mucus production during anesthesia can be copious, and the inspired gases, which are cold and dry, have a drying effect that makes the mucus thick and tenacious. Obstruction of an endotracheal tube can be detected by observing the bird's pattern of ventilation. As the airway progressively occludes, it is observed that the expiratory phase is prolonged. An artificial sigh (inspiration) usually confirms the presence of an obstruction because the abdominal wall is observed to rise and expand in a seemingly normal manner, but returns slowly, or not at all, to its end-expiratory position. This problem must be corrected quickly either by extubating the bird, cleaning the tube and reinserting it, or replacing it with a fresh tube. Airway noises may be heard as the tube becomes more obstructed with mucus; typically, there is a gurgling noise similar to that made by a child blowing air through a straw in a thick milkshake. An anticholinergic, such as atropine (0.04 mg/kg) or glycopyrrolate (0.01 mg/kg), may reduce mucus production and lessen the risk of developing mucus plugs.

If an endotracheal tube has a cuff, either it should not be inflated or it must be inflated with extreme care; in small birds, it is preferred not to inflate the cuff. As mentioned, the trachea is composed of complete cartilaginous rings, and an overly inflated cuff can traumatize the tracheal mucosa at the very least, or at the very worst it may rupture the tracheal rings; my experience has been that when an endotracheal tube cuff is overinflated, the tracheal rings rupture longitudinally rather than circumferentially. Damage to the trachea may not become evident for several days after intubation when the processes of healing and fibrotic narrowing of the trachea finally cause signs of dyspnea.

Most general anesthetics produce muscle relaxation, the degree of which depends on the anesthetic. Because both inspiratory and expiratory muscle activity is essential for ventilation in birds, any depression of muscle activity will affect ventilatory efficiency. Electromyograms from cocks lightly anesthetized with pentobarbital demonstrated that inspiratory and expiratory muscles of ventilation were equally depressed by the anesthetic (Fedde et al., 1964). Although barbiturates depress ventilation in birds, birds anesthetized with these drugs retain their ability to respond to inspired CO₂ (Osborne and Mitchell, 1977, 1978), but this is not true for all anesthetics (see Section III.D).

The position of a bird during anesthesia can significantly affect its ventilation, especially when placed on its back (dorsal recumbency) (King and Payne, 1964). There are a number of factors that contribute to this phenomenon, including the weight of the abdominal viscera that compress the abdominal air sacs thereby reducing their effective volume, and effectively reducing the bird's tidal volume. A well-conditioned bird with large, heavy pectoral muscles and which is in dorsal recumbency, will not only have to deal with the compressive effects of the pectoral

muscle mass, but will have to expend considerable inspiratory effort to lift the keel against gravity.

In general, a bird should be kept at as light a plane of anesthesia as possible so as to reduce muscle relaxation. The ideal body position for an anesthetized bird is lateral recumbency because this position minimally impedes the movement of the keel, and the abdominal viscera do not lie directly over and compress the abdominal and caudal thoracic air sacs.

C. Gas Exchange Component

1. *Tertiary Bronchus or Parabronchus*

The basic unit for gas exchange in birds is the tertiary bronchus, or parabronchus, and its mantle of surrounding tissue. The parabronchi are long narrow tubes, the inner surfaces of which are pierced by numerous openings into chambers called atria. Arising from the floor or abluminal surface of the atria are funnel-shaped ducts, the infundibula, that lead to air capillaries measuring 3–10 μm in diameter that anastomose to form a three-dimensional network, intimately interlaced with a similarly structured network of blood capillaries (Duncker, 1972; McLelland, 1989b). It is within this mantle of interlaced air and blood capillaries, the peri-parabronchial tissue, that gas exchange occurs. The avian lung is rigid and has a constant volume during all phases of ventilation (Klika et al., 1997, 1998; McLelland, 1989b).

There are two types of parabronchial tissue in the avian lung: paleopulmonic and neopulmonic. Paleopulmonic parabronchial tissue consists of essentially parallel, minimally anastomosing parabronchi and is found in all birds. By comparison, neopulmonic parabronchial tissue is a meshwork of anastomosing parabronchi located in the caudolateral portion of the lung; its degree of development is species-dependent (McLelland, 1989b). Penguins and emus only have paleopulmonic parabronchi. Pigeons, ducks, and cranes have both paleopulmonic and neopulmonic parabronchi with the neopulmonic parabronchi accounting for 10–12% of the total lung volume (Fedde, 1980). In fowl-like birds and song birds, the neopulmonic parabronchi are more developed and may account for 20–25% of the total lung volume (Fedde, 1980). The volume of respiratory gas in the avian respiratory system is estimated to be between 100 ml/kg and 200 ml/kg, of which the volume of gas in the parabronchi and air capillaries accounts for only 10% of the total volume. By comparison, the respiratory gas volume of a dog is 45 ml/kg, of which pulmonary gas volume accounts for 96% of the total. Thus, the ratio of gas in the lungs to tidal volume is much smaller in birds than in mammals, which suggests that in birds, especially under anesthesia, the consequences of apnea, especially hypoxemia, may occur more rapidly than in mammals.

Although the paleopulmonic and neopulmonic parabronchi are histologically indistinguishable from each other, the direction of gas flow differs within the two types: during

inspiration and expiration, the direction of gas flow in the paleopulmonic parabronchi is unidirectional, whereas it is bidirectional in the neopulmonic parabronchi (Fig. 18-3) (Fedde, 1980; Scheid and Piiper, 1989a). The unidirectional flow of gas through the intrapulmonary primary bronchus, the secondary bronchi, and the paleopulmonic parabronchi is governed by aerodynamic valves and not by mechanical valves (Banzett et al., 1987, 1991; Brown et al., 1995, 1997; Butler et al., 1988; Jones et al., 1981; Kuethe, 1988; Scheid and Piiper, 1989a; Wang et al., 1988). Aerodynamic valves occur as a consequence of the orientation of secondary bronchial and air sac orifices to the direction of gas flow, elastic pressure differences between the cranial and caudal group of air sacs, and gas convective inertial forces (Banzett and Lehr, 1982; Banzett et al., 1987; Brown et al., 1995; Butler et al., 1988; Kuethe, 1988; Wang et al., 1988).

A cross-current model of gas exchange describes the relationship between gas and blood flows within the avian lung. In birds, there is no equivalent to mammalian alveolar gas because parabronchial gas continuously changes in composition as it flows along the length of the parabronchus (Scheid and Piiper, 1970). The avian lung is so highly efficient at gas exchange that the partial pressure of carbon dioxide in end-parabronchial gas ($P_{E\text{CO}_2}$) can exceed the partial pressure of carbon dioxide in arterial blood ($P_{a\text{CO}_2}$), and the partial pressure of oxygen in end-parabronchial gas ($P_{E\text{O}_2}$) can be lower than the partial pressure of oxygen in arterial blood ($P_{a\text{O}_2}$) (Piiper and Scheid, 1973; Powell and Hopkins, 2004; Powell and Scheid, 1989).

2. *The Gas Exchange Components and Considerations for Anesthesia*

One must always consider assisting or controlling a bird's ventilation during general anesthesia. During positive pressure ventilation, be it manual or mechanical, it is possible that the direction of gas flow within the avian lung may be reversed. Should such a reversal occur, however, it does not affect gas exchange in the avian lung because the efficiency of the cross-current model does not depend on the direction of flow (Scheid and Piiper, 1989a). Studies in which blood gases were collected from mechanically, bi-directionally ventilated birds, did not show an adverse effect of mechanical ventilation on gas exchange (Ludders et al., 1989a; Pettifer et al., 2002; Piiper et al., 1970).

Because of the flow-through nature of the avian respiratory system, it is possible to ventilate birds by flowing a continuous stream of gas through the trachea and lungs, and out through a ruptured or cannulated air sac (Burger and Lorenz, 1960; Burger et al., 1979). This same technique can be used to induce and maintain anesthesia in birds (Burger and Lorenz, 1960; Jaensch et al., 2002; Whittow and Ossorio, 1970; Wijnberg et al., 1991), and it offers a unique, effective means to maintain anesthesia for procedures that require full, unimpeded access to the head. It is also possible to cannulate an abdominal air sac and flow inhalant

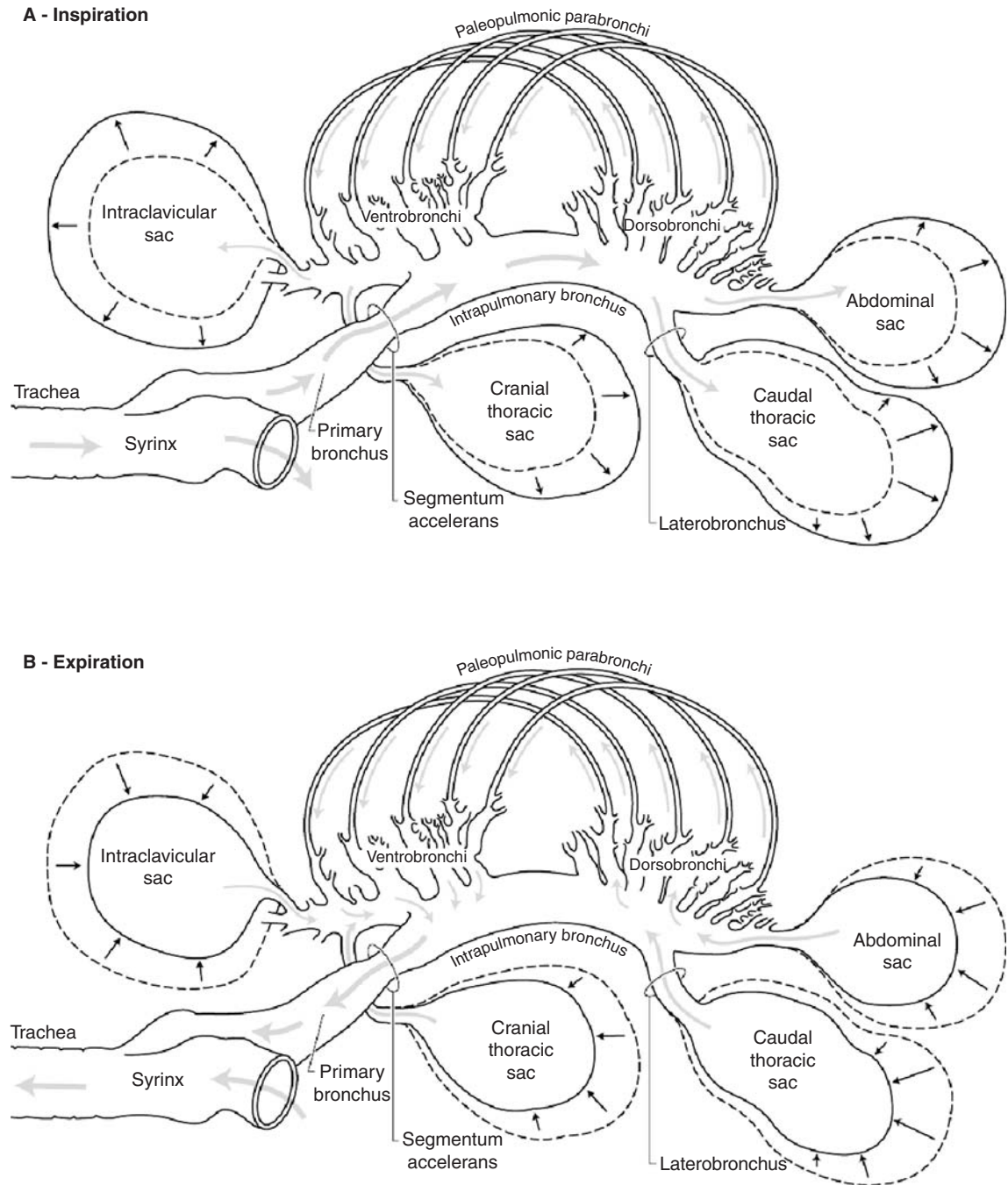

Fig. 18-3 Direction of gas flow in the avian pulmonary system. This drawing of the right paleopulmonic lung and air sacs of a bird shows the pathway of gas flowing through the pulmonary system during (A) inspiration and (B) expiration. For the purpose of clarity, the neopulmonic lung is not shown. Adapted from Fedde (1980) and Brown et al. (1997).

anesthetic through the air sac, across the lung and out via the trachea; this technique has been described in birds as small as zebra finches (Fig. 18-4) (Nilson et al., 2005). In one study of ducks in which arterial blood gases were compared before and after cannulation of the clavicular air sac, the arterial blood gases (P_{aO_2} and P_{aCO_2}) remained unchanged (Rode et al., 1990).

Despite the lack of change in blood gases in this study, the tidal volume increased significantly and there was a doubling of minute ventilation coupled with a slight but insignificant increase in respiratory frequency. However, a report involving sulphur-crested cockatoos (*Cacatua galerita*) reported that the clavicular air sac was not an appropriate route for air sac

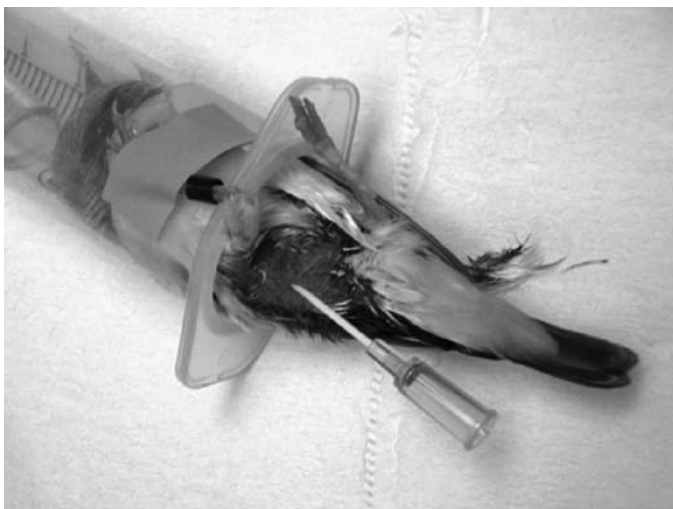

Fig. 18-4 Cannulation of the caudal thoracic air sac for delivery of the inhalant anesthetic isoflurane to a zebra finch. Isoflurane in oxygen is delivered to the hub of the 20-gauge IV catheter. The flow of gas passes through the air sac, across the pulmonary gas exchange surfaces, and out the mouth and nares from where it is scavenged. Photo and permission to publish is kindly provided by Paige C. Nilson (Cornell University) and Professor Stephanie A. White (University of California at Los Angeles).

cannulation and delivery of anesthetic gas because anesthesia could not be maintained in the cockatoos when isoflurane was insufflated through this air sac (Jaensch et al., 2002). This suggests that there may be species differences as to which air sac is best used for cannulation and delivery of inhalant anesthetics.

As mentioned, the avian lung lacks a significant functional residual volume, and this limits the period of time that a bird can remain apneic during anesthesia. During the induction of anesthesia in birds, especially waterfowl, apnea and bradycardia can occur and may last up to 5 minutes. Anesthetic gases are not required to elicit this response as it may occur by placing a mask snugly over a bird's beak and face. This response has been referred to as a dive response, but it is a stress response mediated by stimulation of trigeminal receptors in the beak and nares, at least such is the case in diving ducks (Butler, 1988; Jones et al., 1988; Woakes, 1988). During the stress response, blood flow is preferentially distributed to the kidneys, heart, and brain (Jones et al., 1979). When this stress occurs in birds, it makes safe induction of anesthesia a challenge. This response may be ameliorated by the use of premedicants such as diazepam, midazolam, or butorphanol.

D. Control of Ventilation

Birds have a central respiratory pattern generator, central chemoreceptors that are sensitive to PCO_2 , and many peripheral chemoreceptors that are similar to those found in mammals (Gleeson and Molony, 1989). Birds have a unique group of peripheral receptors located in the lung called intrapulmonary

chemoreceptors (IPCs) that are inhibited by high lung PCO_2 , excited by low lung PCO_2 , and provide phasic feedback for the control of breathing, specifically the rate and depth of breathing (Gleeson and Molony, 1989; Hempleman et al., 2000, 2003; Shoemaker and Hempleman, 2001). These IPCs are not the sole receptors stimulated by inhaled gas containing CO_2 , as stimulation of arterial and central chemoreceptors also occurs (Fedde et al., 2002). However, there may be differences in the responsiveness of a bird to CO_2 depending upon the ecologic niche that it occupies. For example, the CO_2 responsiveness of IPC in chickens, ducks, emus, and pigeons is greater than the IPC of burrowing owls, an avian species that lives underground where the concentration of CO_2 is higher than that of above-ground dwelling birds (Hempleman and Burger, 1985; Kilgore et al., 1985). What exactly this implies for anesthetic management is unknown, but it suggests that under anesthesia there may be species differences in responsiveness to CO_2 .

Just as in mammals, injectable and inhalant anesthetics used in birds can depress both central and peripheral respiratory control mechanisms. More specifically, a number of studies have shown that inhalants depress the responsiveness of a number of peripheral control mechanisms that directly or indirectly affect ventilation (Bagshaw and Cox, 1986; Molony, 1974; Pizarro et al., 1990). As stated before, anesthetic-induced depression of ventilation, including the mechanisms that control ventilation, can be minimized by maintaining a light plane of anesthesia.

E. Cardiovascular System

The avian heart is a four-chambered muscular pump that separates venous blood from arterial blood. Birds have larger hearts, larger stroke volumes, lower heart rates, and higher cardiac output than mammals of comparable body mass (Grubb, 1983). Birds also have higher blood pressures than do mammals (Grubb, 1983; Sturkie, 1986a). The atria and ventricles are innervated by sympathetic and parasympathetic nerves (Sturkie, 1986a), and norepinephrine and epinephrine are the principal sympathetic neurotransmitters while acetylcholine is the principal parasympathetic neurotransmitter. Excitement and handling can increase the concentration of norepinephrine and epinephrine, especially epinephrine, in the heart and blood (Sturkie, 1986a). This has significant implications for anesthetic management because inhalant anesthetics, especially halothane, sensitize the myocardium to catecholamine-induced cardiac arrhythmias. In addition, hypoxia, hypercapnia, and anesthetics, the last depending on the type and dose, depress cardiovascular function.

The conduction system of the avian heart consists of the sinoatrial node, the atrioventricular node and its branches, and Purkinje fibers (Sturkie, 1986b). The pattern of Purkinje fiber distribution within the ventricular myocardium is responsible for QRS morphology. In birds, Purkinje fibers completely penetrate the ventricular myocardium from endocardium to

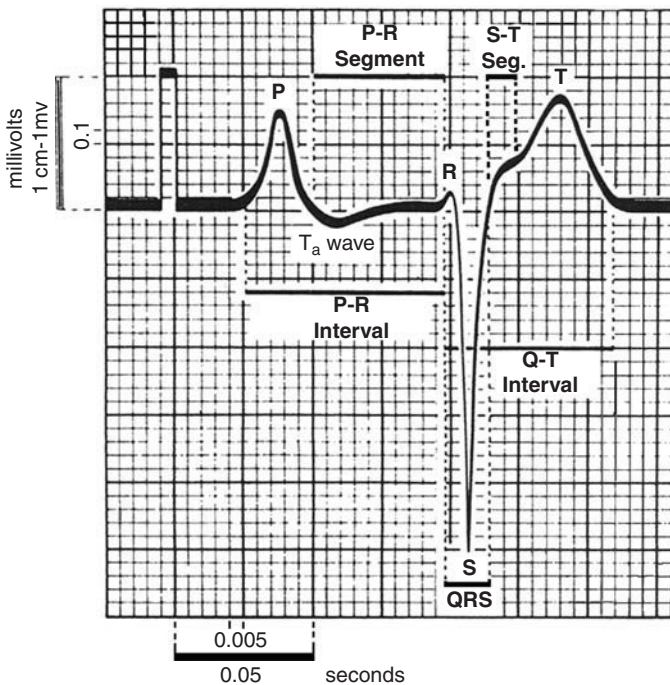

Fig. 18-5 An ECG from a pigeon. To those unfamiliar with the avian ECG complex, an ECG trace from a normal bird may have the appearance of ventricular tachycardia primarily because of the large negative S wave. From Lumeij and Stokhof (1985).

epicardium and the pattern of ventricular activation is described as type 2b, a pattern that may facilitate synchronous myocardial contraction at high heart rates (Keene, and Flammer, 1991). Electrocardiograms have been described for a number of avian species (Keene and Flammer, 1991; Kisch, 1951; Lumeij and Stokhof, 1985; Sturkie, 1986; Zenoble, 1981; Zenoble and Graham, 1979). To those who are unfamiliar with the avian electrocardiogram (ECG) but are familiar with the typical mammalian ECG, the normal avian QRS complex has the appearance of ventricular tachycardia (Fig. 18-5).

III. SPECIFIC CONSIDERATIONS FOR ANESTHESIA

A. Physical Restraint and Examination

Physical restraint is extremely stressful for birds, even for those that outwardly appear to be calm. For example, geese supposedly acclimated to handling and restraint and that seemed outwardly calm, had significant increases in stress-related hormones when handled and restrained (Le Maho, et al., 1992); thus, a bird's behavioral signs do not accurately reflect the *milieu interieur* (Paul-Murphy and Ludders, 2001). A stressed bird is a challenge to anesthetize, so appropriate efforts must be made

to reduce as much as possible the stress of handling; to accomplish this, proper restraint technique is crucial. In addition to the stress of handling, improper capture or restraint can cause physical trauma, including fractures of wings or legs. Because birds cannot dissipate heat through their skin, they can become stressed and easily overheated with prolonged restraint. In general, a bird must be restrained so that its wings and legs are firmly but gently controlled and not allowed to flap or kick about. For long-necked birds, such as herons and cranes, the neck must be controlled so that head, eye, and neck trauma is avoided.

Proper restraint is also necessary to protect personnel working with birds. Each avian species has its own unique and effective mechanisms for defense. Certainly with small species, such as song birds, their defensive mechanisms are of little concern, but larger birds can pose a challenge, especially to inexperienced handlers. Birds of prey, for example, use their talons and inflict severe physical trauma on a handler or assistant, and the risk of infection from such wounds is high. Although most birds of prey do not bite, some, such as great horned owls, will use their talons and beak to great effect. Psittacines have very strong beaks that can cause severe soft tissue injury. Cranes and herons will use their long, pointed beaks in a spearing manner and seem to focus on the handler's eyes. Understanding the physical characteristics and defensive strategies that birds may use is crucial to providing restraint that is safe for both the bird and the people handling it.

Every bird should be subject to a thorough physical examination prior to anesthesia. A number of excellent texts describe in detail the techniques for physical examination and what to look for in specific avian species (Cooper, 2002; Fowler and Miller, 2003; Ritchie et al., 1994). In general, quiet observation of a bird in its cage provides a great deal of information. A bird's awareness of and attention to its environment, body form and posture, feather condition, and respiratory rate all provide clues to its physical condition. Birds should be removed from their cage and examined, with particular attention given to the nares and mouth. A stethoscope with a pediatric head should be used to examine the heart and lungs. At the same time, the sharpness of the keel should be determined as this is a good indicator of muscle mass and body fat.

B. Fasting

Fasting of birds prior to anesthesia and surgery has been controversial. Arguments against fasting stem from a concern that fasted birds may become hypoglycemic because of their high metabolic rate and poor hepatic glycogen storage (Altman, 1980; Franchetti and Klide, 1978). However, because of the hazards associated with regurgitation in minimally fasted birds, some practitioners recommend that avian species, regardless of size, be fasted overnight (Harrison, 1991). A reasonable approach is to hold a bird off food long enough for the upper GI tract to empty, usually overnight in large birds and 4–6 hours in smaller birds (Sinn, 1997). My experience with healthy

waterfowl, cranes, chickens, and psittacines suggests that an overnight fast in these birds is not deleterious and reduces the incidence of regurgitation-associated problems such as aspiration of regurgitated material. If a bird has a full crop, it can be held upright during induction with a finger positioned just below the mandible so as to block the esophagus (Sinn, 1997). Once the bird is anesthetized, the crop can be emptied by placing a finger covered with gauze over the choanal slits to prevent food from entering the nasal cavity, and then milking the food contents out of the crop and esophagus (Sinn, 1997). At the end of anesthesia, the oral cavity should be checked for and cleaned of food material to prevent aspiration.

C. Injectable Anesthetics

Injectable anesthetics are used frequently to produce anesthesia in birds and they have many advantages including low cost, ease of use, and rapid induction of anesthesia; expensive equipment is not required for delivery or maintenance of anesthesia, and pollution of the work environment is not an issue (see Table 18-1 for a selected list of drugs and doses). However, there are inherent disadvantages associated with their use including significant variation between species and individuals in terms of dose and response, difficulty in delivering a safe volume to small birds, ease in overdosing by any route, and difficulty in maintaining surgical anesthesia without severe cardiopulmonary depression, especially for long periods of time; once an injectable anesthetic drug is given the bird's recovery depends upon metabolic and excretory mechanisms. Functionally, the latter consideration means that recoveries may be prolonged and violent (Franchetti, and Klide, 1978). An injectable technique is acceptable for procedures that require anesthesia for up to 20–30 minutes, but an inhalant technique is far better when anesthesia of longer duration is required.

1. Pharmacologic Considerations

Pharmacologic principles that apply to mammals also apply to birds. Pharmacokinetics describe the bioavailability, absorption, distribution, biotransformation, and excretion of a drug, information that can be used to determine drug dose and route of administration. The fate of a drug in the body, including protein binding, volume of distribution, biotransformation, and excretion, differs from species to species because the relationship between biotransformation and excretion is determined by metabolic factors and heredity (Dorrestein, 1991). A frequent misconception is that all birds are similar pharmacologically, but such an approach can lead to undesirable consequences including limited efficacy or intoxication, even among closely related avian species (Dorrestein, 1991). There are alternative methods available for determining safe, effective doses of drugs used in birds. Allometric scaling and the concepts of physiologic time are recognized and accepted alternatives for determining drug doses in lieu of pharmacokinetic data (Boxenbaum, 1982;

Dorrestein, 1991; Schmidt-Nielsen, 1991; Sedgwick and Pokras, 1988). More important, the general principles underlying allometric scaling serve as a rational basis for understanding how drug doses are affected by body mass or metabolic rate. A simple but specific example puts these principles and concepts into perspective. Dosing guidelines for ketamine in birds reflect the allometric concept that drug doses are inversely related to body mass. For example, a recommended dose for ketamine in a small psittacine weighing less than 100 g is 0.07–0.10 mg/g, IM, while a bird weighing over 500 g would receive 0.03–0.06 mg/g, IM (McDonald, 1989). Allometric scaling formulas are useful for highly polar drugs (e.g., aminoglycosides), or drugs that do not require significant biotransformation prior to secretion (e.g., ketamine), but allometric calculations become more complicated and imprecise when attempting to apply them to drugs that require several pathways of biotransformation (Kollias, 2006).

There is very little information about the pharmacodynamics of drugs commonly used in birds, but it is known that there can be significant differences in response among birds to the same drug (Dorrestein and van Miert, 1988; Redig et al., 1984). For example, the commercially available form of ketamine consists of a racemic mixture of its levorotatory and dextrorotatory forms. In great horned and snowy owls, this racemic mixture characteristically induces chemical restraint and anesthesia of poor quality (Redig et al., 1984). When great horned owls receive only the dextrorotatory form of ketamine, anesthesia induction is smoother with fewer cardiac arrhythmias, whereas the levorotatory form is associated with inadequate muscle relaxation, cardiac arrhythmias, and excited behavior during recovery (Redig et al., 1984). Whether these differences are due to differing pathways for drug metabolism among birds, production of pharmacologically active metabolites, or differences in types of receptors or receptor sensitivity are not known. It is incumbent upon the investigator who is working with a particular species of a bird to be familiar with the typical, expected response of that species to drugs that are being considered for anesthesia.

2. Injection Sites

Subcutaneous (SQ) injection sites include the area over the back between the wings, the wing web, and the skin fold in the inguinal region. The pectoral and thigh muscles can be used for intramuscular (IM) injections. Twenty-five or 27 gauge hypodermic needles should be used for SQ, IM, or IV injections. The ulnar vein, dorsal metatarsal vein, and jugular vein can be used for IV injections as well as for catheterization. In general, the right jugular vein is larger and easier to visualize than the left jugular vein, and it is an easy vessel from which to draw blood or to catheterize.

3. Specific Drugs

Ketamine, diazepam, xylazine, or medetomidine have been used to induce anesthesia of relatively short duration in a variety

of birds. Ketamine produces a state of catalepsy and can be given by any parenteral route; doses range from 10 mg/kg to 200 mg/kg depending on species and route of administration. Drugs such as diazepam, midazolam, or xylazine have been combined with ketamine in order to prolong or improve the quality of ketamine anesthesia, provide muscle relaxation, or provide additional analgesia. When used alone, ketamine produces suitable chemical restraint for minor surgical and diagnostic procedures, but it is not a general anesthetic and is not suitable for major surgical manipulations (McGrath et al., 1984; Salerno and van Tienhoven, 1976). Higher doses of ketamine only serve to prolong its duration of action while decreasing its margin of safety (McGrath et al., 1984).

Diazepam is a tranquilizer with excellent muscle relaxant properties. As with all tranquilizers, it lacks analgesic properties and should not be viewed as providing additional analgesia when combined with primary anesthetics such as ketamine. Diazepam can be used to tranquilize a bird prior to mask induction with an inhalant anesthetic, thus reducing the stress and struggling associated with anesthetic induction. An important feature of diazepam is that its duration of action is short and recovery is not prolonged.

Midazolam is a more potent, longer acting benzodiazepine. In Canada geese, midazolam (2 mg/kg, IM) induced adequate tranquilization for radiography that lasted up to 20 minutes after injection (Valverde et al., 1990). Mean arterial blood pressure remained stable, and arterial blood gases were unchanged from baseline values (Valverde et al., 1990). In a study of quail (*Colinus virginianus*), midazolam (6 mg/kg, IM) produced heavy sedation in 9 out of 10 birds and mild sedation in one; time to peak onset of sedation was 10 minutes after administration and, as judged by heart and respiratory rates, there were no alterations in cardiopulmonary function (Machin and Caulkett, 2000). Midazolam appears to be a safe drug that can be used to facilitate induction of anesthesia or provide a variable period of sedation for minor, nonpainful procedures such as radiography. In raptors and pigeons, the effects of midazolam last for several hours after the termination of anesthesia. Although there have been no reports of complications associated with midazolam and prolonged recoveries, such recoveries are considered an undesirable feature of any drug.

Xylazine, an α_2 -adrenergic agonist with sedative and analgesic properties, has been used for minor surgical and diagnostic procedures. It has profound cardiopulmonary effects, including second-degree heart block, bradyarrhythmias, and increased sensitivity to catecholamine-induced cardiac arrhythmias. To enhance its sedative and analgesic properties, xylazine is frequently combined with other anesthetic drugs such as ketamine. In some species, when used alone in high doses, xylazine can cause respiratory depression, excitement, and convulsions (Samour et al., 1984). Hypoxemia and hypercapnia were observed in Pekin ducks given xylazine or a combination of xylazine and ketamine (Ludders et al., 1989b).

Medetomidine, a more potent and specific α_2 -adrenergic agonist than xylazine, has been used alone in birds (Cherdchanpipat et al., 1989; Leonardi et al., 2004; Mohammad et al., 1997; Pollock et al., 2001; Sandmeier, 2000), or in combination with other drugs (Abass et al., 1999; Atalan et al., 2002; Blogg et al., 1998; Kalpravidh 1991; Leonardi et al., 2004; Lumeij and Deenik, 2003; Machin and Caulkett, 1998; Mohammad et al., 1997; Pollock et al., 2001; Sandmeier, 2000) to produce sedation or anesthesia. When used alone, its degree of sedation and duration of effect are variable and depend on dose and species. In zebra-doves (*Geopelia striata*) injected with medetomidine (250 μ g/kg, IM), the onset of sedation occurred within 9 minutes and lasted for 5 hours (Cherdchanpipat et al., 1989). In domestic pigeons, a combination of medetomidine (125 μ g/kg, IM) and ketamine (30 mg/kg, IM) provided a deeper plane of anesthesia with better analgesia than did a combination of diazepam (2 mg/kg, IM) and ketamine (60 mg/kg, IM), but the level of anesthesia was unreliable in that birds exhibited violent wing flapping (Lumeij and Deenik, 2003). Recovery was rapid and smooth in the pigeons given medetomidine–ketamine and prolonged in pigeons given diazepam–ketamine (Lumeij and Deenik, 2003).

To hasten recovery from or treat an overdose of an α -adrenergic agonist, an α -adrenergic antagonist such as tolazoline, yohimbine, or atipamezole can be used. Turkey vultures anesthetized with a combination of xylazine and ketamine regained consciousness approximately 4 minutes after tolazoline (15 mg/kg) was given intravenously (Allen and Oosterhuis, 1986). Red-tailed hawks anesthetized with a combination of xylazine and ketamine recovered from anesthesia significantly faster after receiving yohimbine than birds not receiving the antagonist (Degernes et al., 1988). In addition, a yohimbine dose of 0.1 mg/kg was effective and did not produce clinically significant cardiopulmonary changes (Degernes et al., 1988). In domestic pigeons, the effects of anesthesia with medetomidine, butorphanol, and ketamine were incompletely reversed with atipamezole injected intramuscularly 60 minutes after the ketamine was injected; arousal was observed to occur within 10 minutes of injection (Atalan et al., 2002).

Propofol has been used in a variety of birds, including chickens (Lukasik et al., 1997), pigeons (Fitzgerald and Cooper, 1990), barred owls and rheas (Clippinger et al., 2000), red-tailed hawks and great horned owls (Hawkins et al., 2003), canvas-back and mallard ducks (Machin and Caulkett, 1998, 2000), barn owls (Mama et al., 1996; Mikaelian, 1991), Hispaniolan parrots (Langlois et al., 2003), a common buzzard and tawny owl (Mikaelian, 1991), spectacled and king eiders (Mulcahy et al., 2003), and wild turkeys (Schumacher et al., 1997). Its effects are characterized by a rapid onset of action, but the speed of recovery may be variable and is species dependent. A characteristic side effect of the drug is hypoventilation, or apnea, and hypoxemia. In chickens and pigeons, propofol produced respiratory depression and apnea, and the lethal dose appeared to be close to the induction dose in these species (Fitzgerald and Cooper,

1990; Lukasik et al., 1997). In red-tailed hawks and great horned owls, propofol decreased effective ventilation and recovery was prolonged with some birds exhibiting moderate to severe signs of CNS excitation (Hawkins et al., 2003). Hispaniolan parrots anesthetized with propofol had prolonged recoveries compared to when they were anesthetized with isoflurane (Langlois et al., 2003). Wild turkeys, induced (5 mg/kg, IV) to anesthesia and maintained (0.05 mg/kg/min, IV) with propofol, became apneic and remained so for 10–30 seconds after induction; their respiratory rate was significantly decreased at 4 minutes after administration of propofol and remained so throughout the period of infusion (Schumacher et al., 1997). Two male turkeys developed severe transient hypoxemia, one at 5 minutes and the other at 15 minutes after induction (Schumacher et al., 1997). The turkeys stood after an average of 11 minutes following discontinuation of the propofol infusion (Schumacher et al., 1997).

Surgical anesthesia can be maintained for relatively long periods of time (1–12 hours) by using intermediate- or long-acting barbiturates, or combinations of drugs with an intermediate duration of effect. Pentobarbital (25–30 mg/kg, IV) can produce anesthesia for several hours (Fedde, 1978). However, the drug requires 10–15 minutes to achieve its full effect, so it must be administered initially as a bolus consisting of half the total dose with the remainder titrated over several minutes until the desired plane of anesthesia is achieved. Patience is indeed a virtue when using this drug to produce anesthesia in birds.

Phenobarbital is a long-acting barbiturate that can produce long-lasting anesthesia, up to 24 hours when administered at 130 mg/kg (Fedde, 1978). Its onset of action is very slow, requiring as much as 30 minutes before surgical anesthesia is achieved. As is true for pentobarbital, additional doses of phenobarbital can be administered as needed to deepen the plane of anesthesia, but there is a narrow margin between satisfactory anesthesia and severe respiratory and cardiac depression to the point of death. If patience is a virtue when using pentobarbital, it is a near saintly characteristic when using phenobarbital!

Equithesin is a combination of pentobarbital, chloral hydrate, and magnesium sulfate; it is not available commercially and those who use it make it themselves. It does not produce a surgical plane of anesthesia in domestic fowl when used alone, but according to one report, it does produce surgical anesthesia lasting for as long as 90 minutes when combined with diazepam (Christensen et al., 1987). This latter finding is somewhat surprising because diazepam is devoid of analgesic properties.

4. Local Anesthetics

Local anesthetics have produced seizures and cardiac arrest in birds (Fedde, 1978), but these problems have occurred as a result of gross overdosing in small birds (Franchetti and Klide, 1978). For example, 0.1 ml of lidocaine 2% (20 mg/ml) administered intramuscularly or subcutaneously to a 30 g parakeet is equivalent to 67 mg/kg, a gross and toxic overdose for any animal.

Lidocaine can be used in birds for local anesthesia, but the dose must not exceed 4 mg/kg, which is difficult to achieve in very small birds unless the drug is diluted. Although local anesthetics provide sufficient local or regional anesthesia, they do nothing for the stress induced by physical restraint and handling of an awake bird.

5. Opioids, Non-steroidal Anti-inflammatory Drugs, and Pain

The lack of an anthropocentric type of response by birds to pain does not necessarily mean that they do not perceive pain or that it does not cause them distress. It may be that the behavioral or physiological variables associated with pain in birds have not been adequately characterized, and there are a number of reasons for this (Paul-Murphy and Ludders, 2001). To accurately assess pain in birds requires that the observer be familiar with normal and pain-associated behavior of a given species as well as of the individual bird (Clyde and Paul-Murphy, 1999). An example serves to make this point: of all the normal behaviors that a chicken can display, dust bathing is the single best behavioral indicator of pain, and this behavior is significantly reduced in chickens with arthritis (Vestergaard and Santora, 1999). Dust bathing, however, is not a normal behavior of other avian species and so it cannot be used as an indicator of pain in other birds.

The problem of recognizing pain in birds has been confused by research investigating the effects of opioids in birds. In contrast to studies of the analgesic effects of opioids in mammals, the objective of opioid studies in birds has been, in general, to evaluate their effect on learned behavior, not analgesia (Fitzgerald and Cooper, 1990; France and Woods, 1987; Herling et al., 1984; Leander, 1983; Leander and McMillan, 1977). The few studies evaluating the analgesic effects of opioids in birds are conflicting. In one study, morphine produced hyperalgesia (Hughes, 1990), while in another it produced analgesia (Bardo and Hughes, 1978). The results of a study in chickens indicated that motor deficits associated with the administration of morphine might mask its analgesic effects (Rager and Gallup, 1986). More recent studies of mu opioids suggest that their analgesic effects can be variable. For example, fentanyl (0.01 and 0.02 mg/kg, IM) was rapidly absorbed when given to white cockatoos (*Cacatua alba*) weighing 572 ± 125 g, and its elimination half-life was 1.2–1.4 hours (Hopps et al., 2003). In the same study, fentanyl was given at 0.02 mg/kg, IM, or 0.2 mg/kg, SQ, and in terms of response to pain, there was no difference in response times between saline injection and fentanyl at the lowest dose even though plasma levels for over two hours following its administration were at concentrations considered analgesic in humans. (Hopps et al., 2003). The higher dose provided significant analgesia in some birds while caused excitement in others, but its delivery required a large volume (approximately 2.3 ml per 572 g bird) (Hopps et al., 2003). In African gray parrots, buprenorphine (0.1 mg/kg, IM), a partial mu agonist, had no analgesic effects when compared

to saline (Paul-Murphy et al., 1999). These studies suggest that mu opioids provide inadequate analgesia to birds.

Kappa opioids such as butorphanol appear to provide effective analgesia to birds. Kappa opioid receptors account for 76% of the radiolabeling of pigeon forebrain tissues, a finding that may explain why kappa opioid agonists like butorphanol, and not mu opioids, are effective analgesics in birds (Mansour et al., 1988). Butorphanol has been shown to produce analgesia in cockatoos and African gray parrots (Curro et al., 1994; Paul-Murphy and Ludders, 2001; Paul-Murphy et al., 1999).

Nonsteroidal anti-inflammatory drugs (NSAIDs) can be used to provide analgesia to birds, but there can be significant pharmacokinetic differences depending on the drug and the species (Baert and De Backer, 2003) that may, as in mammals, result in significant gastrointestinal or renal toxicity (Mulcahy et al., 2003; Oaks et al., 2004; Paul-Murphy and Ludders, 2001). Carprofen administered at 1 mg/kg, SQ, has been recommended for analgesia (Paul-Murphy and Ludders, 2001), but another study of chickens with sodium urate-induced articular pain suggests that a dose of 30 mg/kg may be necessary for effective analgesia (Hocking et al., 2005). The latter study also recommended that ketoprofen for analgesia be administered at a dose of 12 mg/kg (Hocking et al., 2005).

D. Inhalant Anesthetics

Inhalant anesthetics, especially isoflurane, are considered the anesthetics of choice for birds, and they offer several advantages for patient management not provided by injectable drugs (Ludders and Matthews, 1996; Roberson et al., 2000). Advantages include rapid induction and recovery, especially when inhalant anesthetics with low blood-gas solubility are used (isoflurane and sevoflurane), easier control of anesthetic depth, the concurrent use of oxygen with inhalants which provides respiratory support, and fast recovery that is independent of metabolic or excretory pathways. A disadvantage is that the delivery of the potent inhalants requires special equipment such as a source of oxygen, a vaporizer, a breathing circuit, and a mechanism for scavenging waste anesthetic gases, the latter unnecessary in a field (outdoor) situation.

E. Breathing Circuits and Fresh Gas Flows

Nonbreathing circuits, such as the Bain circuit or Norman elbow, are ideal for use in birds because they offer minimal resistance to patient ventilation. An additional advantage to the plastic Bain circuit is that it is light in weight, an advantage when used in very small birds. When a nonbreathing circuit is used, oxygen flows should be two to three times minute ventilation, or 150–200 mL · kg⁻¹ · min⁻¹.

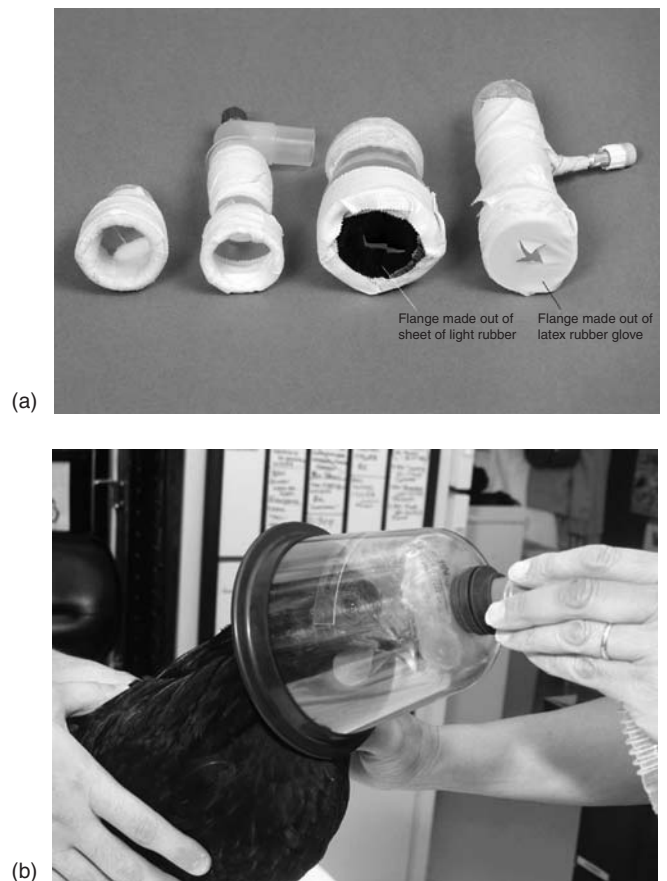

Fig. 18-6 Masks. (a) A variety of “home made” masks assembled from syringe cases and liberal amounts of tape, a key ingredient in their construction. An important feature of any mask is that it fits snugly over a bird’s beak or bill so that oxygen and anesthetic gas are delivered to the bird and not the work environment. The two masks on the right have flanges made of light rubber (black flange) or latex rubber (white) from a surgical glove to make a tighter seal around a bird’s beak or head. (b) A chicken being induced to anesthesia with isoflurane in oxygen, delivered with a coaxial nonbreathing circuit attached to a mask typically used for masking dogs to anesthesia. The black rubber flange fits snugly around the bird’s neck and minimizes but does not prevent pollution of the work environment with waste anesthetic gas.

F. Induction Methods

The number and the variety of techniques which may be used for inducing anesthesia in birds by inhalation anesthetics are only limited by the anesthetist’s imagination. Birds can be induced with commercially available masks designed for small animals, or with homemade masks fabricated from plastic bottles, syringe cases, syringe barrels, or breathing hose connectors. Mask induction techniques can be used in a wide variety and size of birds, from the very small up to and including emu (Fig. 18-6). Mask inductions are unsatisfactory in adult ostriches. Birds can be induced to anesthesia by inserting their heads into a clear plastic bag into which oxygen and anesthetic vapor are introduced via a nonbreathing circuit. They can also be induced to anesthesia in a clear, leak-proof chamber, but a

TABLE 18-3

MINIMUM ANESTHETIC CONCENTRATION (MAC) FOR THREE INHALANT ANESTHETICS—HALOTHANE, ISOFLURANE, AND SEVOFLURANE—IN BIRDS

Bird	Halothane (%)	Isoflurane (%)	Sevoflurane (%)
Chicken	0.85 ^a	1.25 ^b	2.21 ^c
Cockatoo	—	1.44 ^d	—
Duck	1.05 ^e	1.32 ^f	—
Sandhill crane	—	1.35 ^g	—

^aLudders et al. (1988).

^bNaganobu and Hagio (2000).

^cNaganobu et al. (2000).

^dCurro et al. (1994).

^eLudders (1992).

^fLudders et al. (1990).

^gLudders et al. (1989a).

disadvantage of this technique is that the anesthetist is not in physical contact with the bird and is unable to get a feel for how the bird is responding to the anesthetic. In addition, birds in a chamber can injure themselves as they pass through stage II anesthesia, the involuntary excitement stage. Whatever technique is used, the anesthetist must take precautions to prevent anesthetic gas pollution of the work environment. When using a mask it should fit snugly over the bird's beak and face, or over its entire head. If a plastic bag or chamber is used, it should be free of leaks. Once induction is completed, the bag or chamber must be removed from the work area without "dumping" the anesthetic gas contents into the workplace environment.

G. Minimum Anesthetic Concentration (MAC)

The MAC of an inhalant anesthetic that produces anesthesia in mammals exposed to a noxious stimulus is a measure that provides a description of concentration and effect of an inhalant, and it applies equally to all inhalant anesthetics. For birds, because they do not have an alveolar lung, MAC is defined as the minimal anesthetic concentration required to prevent gross purposeful movement in a bird subjected to a noxious stimulus (Ludders et al., 1989a). In birds MAC is determined in a manner similar to how it is determined in mammals; thus, the MAC values for halothane, isoflurane, and sevoflurane in birds (Ludders, 1992; Ludders et al., 1988, 1989a, 1990; Naganobu et al., 2000, 2003) are similar to MAC values reported for mammals (Table 18-3) (Quasha et al., 1980).

H. Halothane, Isoflurane, and Sevoflurane

Halothane, isoflurane, and sevoflurane are the most commonly used inhalant anesthetics in birds. Of these three inhalants, isoflurane is preferred for use in birds. Halothane, isoflurane and sevoflurane, at all end-tidal anesthetic concentrations and in a dose-dependent manner, depress ventilation

(Korbel, 1998; Ludders, 1992; Ludders et al., 1988, 1989a, 1990; Naganobu et al., 2000, 2003). More specifically, as the concentration of anesthetic increases the partial pressure of carbon dioxide in arterial blood increases significantly. Anesthetic index (AI) is a measure of the tendency for an inhalant anesthetic to cause respiratory depression and apnea (Regan and Eger, 1967); the lower the AI of an inhalant anesthetic, the greater is its depressant effect on ventilation. In ducks anesthetized with halothane, AI was found to be 1.51 or lower (Ludders, 1992), while the AI for ducks anesthetized with isoflurane was 1.65 (Ludders et al., 1990). These AI values are considerably lower than those reported for dogs (Steffey and Howland, 1977, 1978), cats (Steffey and Howland, 1977), or horses (Steffey et al., 1977), and suggest that halothane and isoflurane depress ventilation more in birds than in mammals.

The effect of halothane on blood pressure can be variable. In chickens and ducks, increasing concentrations of halothane cause a decrease in mean arterial blood pressure (Goelz et al., 1990; Ludders et al., 1988), or no change (Ludders, 1992). In contrast, isoflurane appears to consistently cause a dose-dependent decrease in mean arterial blood pressure (Goelz et al., 1990; Greenlees et al., 1990; Ludders et al. 1989a, 1990), possibly because of isoflurane-associated peripheral vasodilation. Sevoflurane in chickens has been reported to decrease blood pressure in a dose-dependent manner during controlled ventilation, but not during spontaneous ventilation, probably because of the attendant hypercapnia (Naganobu et al., 2003).

Cardiac arrhythmias frequently occur in birds anesthetized with halothane. In contrast, cardiac stability is one of the perceived clinical advantages of isoflurane. However, in an electric fibrillation model, isoflurane was found to lower the threshold for electric fibrillation more so than halothane (Greenlees et al., 1990). The reasons for the discrepancy between clinical experience and the result of this study are not clear, but hypoventilation, a common occurrence during general inhalant anesthesia, may have been a contributing factor. Not only does hypoventilation make it difficult to control the plane of anesthesia, it can have a variety of adverse effects on cardiopulmonary function through direct or indirect mechanisms. For example, in 6 of 12 ducks held at a constant end-tidal halothane concentration of 1.5% while PaCO₂ was varied from 40 mmHg to 80 mmHg, unifocal and multifocal cardiac arrhythmias occurred (Naganobu et al., 2001). The mean PaCO₂ at which arrhythmias developed was 67 ± 12 mmHg; in five of six ducks with arrhythmias, the arrhythmias disappeared after CO₂ inhalation was terminated (Naganobu et al., 2001). To avoid hypoventilation and hypercarbia during general inhalant anesthesia, ventilation in birds should be assisted or controlled using either manual or mechanical means.

Nitrous oxide can be used as an adjunct to general anesthesia in birds, but not as the sole anesthetic (Arnall, 1961). A study of pigeons showed that nitrous oxide (50%) decreases the concentration of isoflurane necessary to maintain a suitable plane of anesthesia by only 11% (Korbel et al., 1996).

This confirms that nitrous oxide is a weak anesthetic and must not be used as the sole anesthetic for birds undergoing painful procedures. As with any anesthetic gas or vapor, nitrous oxide is not uniquely sequestered or concentrated in air sacs. The decision to use nitrous oxide depends on whether a bird has adequate pulmonary function and whether sufficient oxygen can be delivered to meet its metabolic demands. Thirty percent oxygen (balance nitrous oxide) is generally considered the minimum fraction of inspired oxygen to be delivered to an anesthetized animal so as to meet its metabolic needs and prevent hypoxemia. However, if 30% oxygen is delivered to a bird that also is anesthetized with an inhalant anesthetic such as isoflurane, the bird may hypoventilate to such a degree that it will become hypoxic despite the administration of 30% oxygen. When using nitrous oxide, 50% oxygen is generally delivered so as to avoid hypoventilation-associated hypoxemia.

Nitrous oxide may cause problems in some avian species. For example, pelicans have SQ pockets of air that do not communicate with the respiratory system, and the use of nitrous oxide in these birds can result in SQ emphysema (Reynold, 1983).

I. Adjuncts to General Anesthesia

Muscle paralytics may be useful in the anesthetic management of birds, especially during long surgical procedures requiring adequate muscle relaxation and immobility. However, muscle paralytics are devoid of any analgesic or anesthetic properties and for this reason they must never be used alone in any animal including birds. Atracurium is a nondepolarizing muscle relaxant with short duration of effect and minimal cardiovascular effects. Its neuromuscular and cardiovascular effects in anesthetized chickens have been reported (Nicholson and Ilkiw, 1992). The effective dose associated with 95% twitch depression in 50% of birds ($ED_{95/50}$) given atracurium was 0.25 mg/kg, and $ED_{95/95}$ was calculated to be 0.46 mg/kg. The duration of action of the 0.25 mg/kg dose was 34.5 ± 5.8 minutes, and 47.8 ± 10.3 minutes at the highest dose of 0.45 mg/kg. Edrophonium (0.5 mg/kg, IV) reversed the effects of atracurium. There were small, but statistically significant, changes in cardiovascular variables, in that heart rate decreased and blood pressure increased after atracurium was administered, but these changes were considered unimportant clinically (Nicholson and Ilkiw, 1992).

The avian iris has skeletal muscles that control pupillary diameter and for this reason neuromuscular paralytics have been used to produce mydriasis. In a study of three paralytics (d-tubocurarine, pancuronium, and vecuronium) and two autonomic drugs (atropine and phenylephrine) administered to three avian species—adult cockatoos (*Cacatua sulphurea*), African gray parrots (*Psittacus erithacus*), and blue-fronted Amazon parrots (*Amazona aestiva*)—vecuronium produced the most consistent and greatest pupillary dilatation and did so with the fewest systemic side effects (Ramer et al., 1996). In juvenile

double-crested cormorants (*Phalacrocorax auritus*), vecuronium alone or in combination with atropine and phenylephrine were evaluated as mydriatics (Loerzel et al., 2002). The cormorants were treated with each of the four drug treatments: atropine (1%); vecuronium (total 0.16 mg/eye); atropine with vecuronium; and atropine plus phenylephrine (2.5%), followed by vecuronium. The treatment of atropine, phenylephrine and vecuronium provided the most consistent dilation with larger average pupil size and longer average duration of effect; no side effects from vecuronium were observed in these birds (Loerzel et al., 2002).

J. Monitoring

Birds must be monitored during anesthesia. Physiologic variables to monitor include respiratory rate and tidal volume, oxygenation, heart rate and rhythm, body temperature, and muscle relaxation. Both respiratory rate and tidal volume should be monitored during anesthesia in order to assess the adequacy of ventilation and the depth of anesthesia. Respiratory frequency by itself is often misleading as to the adequacy of ventilation and anesthetic depth. High respiratory frequencies in an anesthetized bird do not necessarily indicate that the bird is light or that it is hyperventilating. More often high respiratory frequencies are associated with small tidal volumes and a greater proportion of dead space ventilation than with effective ventilation (Ludders et al., 1989). The end result is hypercarbia.

Ventilation can be monitored by watching the frequency and the degree of motion of the sternum or movements of the breathing circuit reservoir bag. Capnography can also be used to monitor ventilation in birds, but accurate sampling of airway gas for measurement of CO_2 may require adjustments in sampling flow rate so as to adjust for fresh gas flows and type of breathing circuit which may affect the accuracy of measuring CO_2 (Edling et al., 2001). When monitoring ventilation in birds, respiratory pauses longer than 10 to 15 seconds should be treated by lightening the plane of anesthesia and ventilating the bird by either periodically squeezing the reservoir bag or using a positive pressure mechanical ventilator. During positive pressure ventilation, airway pressure should not exceed 15–20 cm H_2O pressure to prevent volutrauma to the air sacs. The adequacy of ventilation can be assessed by noting the color and capillary refill time of mucous membranes. The color of the cere and beak or bill can give an indication of the adequacy of cardiopulmonary function and oxygenation. For example, chickens with combs or wattles that are normally a red or pink color, will lose their color (typically they develop a yellow color) when cardiac output or oxygenation is poor.

Pulse oximeters can be used to monitor oxygenation, but the typical pulse oximeter is designed to measure oxygenated and deoxygenated mammalian hemoglobin, not avian hemoglobin. Although pulse oximeters may track trends in oxygenation, they tend to underestimate oxygenation levels at high oxygen

saturation levels and overestimate oxygenation levels at lower saturation levels because of the differences between avian and mammalian hemoglobin (Schmitt et al., 1998).

The heart is an electromechanical pump, and the blood vessels are the conduits for its output. Although the ECG provides information about the electrical activity of the heart, it does not provide information about pump function. The adequacy of pump function is assessed by monitoring mucous membrane color and refill time, blood pressure, and by palpating peripheral pulses. The ECG can be monitored by using standard bipolar and augmented limb leads. To assure adequate skin contact so as to gain an interference-free signal, ECG clips can be attached to hypodermic needles inserted through the skin at the base of each wing and through the skin at the level of each stifle. Alternatively, the ECG clips can be attached to stainless steel wires that have been inserted through the prepatagium of each wing and the skin at the lateral side of each stifle; the size of the wire to be used depends on the size of the bird. Twenty- or 22-gauge wire can be used in birds heavier than 500 g. Appropriately sized hypodermic needles are used to insert the wires through the skin.

Pump function can be assessed by monitoring the pulsations of blood through a peripheral artery or by monitoring blood pressure. It is possible to directly monitor arterial blood pressure in birds heavier than 4 kg, but this technique is not feasible in smaller birds. The Doppler flow probe (Parks Electronics, Aloha, Oregon) is an effective device for monitoring blood flow in small birds, and blood flow or blood pressure in birds of moderate to large size. With the Doppler probe secured in position over a peripheral artery, pulse rate and rhythm can be determined. The probe can be placed over a digital artery, and a sphygmomanometer attached to a cuff placed around the leg can be used to indirectly measure arterial blood pressure. Another technique that can be used to monitor the heart is to tape the Doppler device probe to the lateral thoracic wall over the heart. This provides an audible monitor of the beating heart, but it does not provide information about pump function or blood pressure.

Body temperature should be monitored for a number of reasons. The stress associated with anesthesia and surgery is minimized when birds are maintained at or near their normal body temperature. During anesthesia it is not unusual to see major fluctuations in body temperature, but hypothermia is the most common problem, one that decreases the amount of anesthetic needed to maintain anesthesia, causes cardiac instability, and prolongs recovery. In well-insulated birds (feathers, drapes, heating pads) hyperthermia can occur and also cause cardiac instability and an increased demand for oxygen. Body temperature can be reliably monitored with an electronic thermometer and a long flexible thermistor probe inserted into the esophagus to the level of the heart. Cloacal temperature can vary significantly over time due to movements of the cloaca that affect the position of the thermometer or thermistor probe. Body temperature can be adjusted by inserting or removing pads or blankets between the bird and cold surfaces, using circulating warm water blankets (not electric heating pads), maintaining a light

plane of surgical anesthesia, raising or lowering the environmental temperature, or wetting the bird's legs with alcohol. In a report involving Hispaniolan Amazon parrots, the most effective method for maintaining body temperature was a forced-air warming device (Rembert et al., 2001). Even though such a device may not prevent an initial drop in core body temperature, in this report it appeared to maintain body temperature within a clinically acceptable range (Rembert et al., 2001).

K. Recovery

Birds must be lightly restrained during recovery so that they do not flop around and cause serious neck, wing, or leg injuries to themselves. Struggling and flopping behavior can be prevented by lightly wrapping a bird with a towel, but wrapping it too tightly may impede sternal movements and impair breathing. Wrapping also can lead to excessive retention of body heat and cause hyperthermia. If a bird has not been fasted prior to anesthesia, regurgitation may occur during recovery. Keeping a bird intubated during the recovery phase helps to maintain an open airway and protect it from regurgitated material.

IV. EUTHANASIA OF BIRDS

A full discussion of acceptable methods of euthanasia of birds is not possible in this section; for a full discussion of this subject the reader is referred to the 2000 Report of the AVMA Panel on Euthanasia (2001). In short, an IV injection of a concentrated solution of pentobarbital is a very effective and humane means for euthanizing birds. Decapitation, although aesthetically unpleasant, is considered humane. Wringing a bird's neck is not euthanasia and is unacceptable. I also have reservations concerning thoracic compression, which has been advocated as a means of euthanizing birds in field conditions. My reservations stem from the fact that the mechanism by which this technique supposedly produces euthanasia ignores some fundamental aspects of avian anatomy (Ludders, 2001). Advocates of thoracic compression state that this technique stops the heart and lungs from moving. Anyone who has tried to resuscitate a bird by compressing the keel after a cardiac arrest knows how difficult it is to compress the heart and generate a pulsatile flow of blood. This is probably because of the cushioning and protective effects of the thoracic air sacs around the heart. As mentioned previously, the avian lung is a relatively rigid organ located in the dorsal portion of the thoracic cavity, so it is impossible to stop that which never moves. It is my belief that this method causes death by suffocation, a method that is not necessarily rapid nor pain and stress free; there must be minimal pain and stress for a technique to be considered euthanasia. When in doubt about the humaneness of a technique for euthanizing a bird, the benefit of the doubt should always go to the bird and this technique, until proven otherwise, seems dubious.

V. RECOMMENDED READING

Heard Darryl, J. (2001). Analgesia and anesthesia. *Vet. Clin. North Am. Exot. Anim. Pract.* **4**(1), 35–45 Joanne Paul-Murphy and John W. Ludders 147–167 Moha Abou-Madi.

Fedde, M.R. (1978). Drugs used for avian anesthesia: A review. *Poult. Sci.*, **57**(5), 1376–1399. [NB: although an old article, it contains a great deal of useful information concerning drugs, doses, and their acceptability for producing anesthesia in birds.]

REFERENCES

- AVMA Panel on Euthanasia. (2001). 2000 Report of the AVMA Panel on Euthanasia. *J. Am. Vet. Med. Assoc.* **218**(5), 669–696.
- Abass, B.T., Ayoub, R.S., and Al-Hasan, A.M. (1999). The use of medetomidine–fentanyl combination in chickens. *Iraqi J. Vet. Sci.* **12**(1), 57–59.
- Allen, J.L., and Oosterhuis, J.E. (1986). Effect of tolazoline on xylazine–ketamine-induced anesthesia in turkey vultures. *J. Am. Vet. Med. Assoc.* **189**(9), 1011–1012.
- Altman, R.B. (1980). Avian anesthesia. *Compend. Contin. Educ.* **2**, 38.
- Arnall, L. (1961). Anaesthesia and surgery in cage and aviary birds (I). *Vet. Rec.* **73**, 139.
- Atalan, G., Uzun, M., Demirkan, I., Yildiz, S., and Cenesiz, M. (2002). Effect of medetomidine–butorphanol–ketamine anaesthesia and atipamezole on heart and respiratory rate and cloacal temperature of domestic pigeons. *J. Vet. Med. A Physiol. Pathol. Clin. Med.* **49**(6), 281–285.
- Baert, K., and De Backer, P. (2003). Comparative pharmacokinetics of three non-steroidal anti-inflammatory drugs in five bird species. *Comp. Biochem. Physiol. C Toxicol. Pharmacol.* **134**(1), 25–33.
- Bagshaw, R.J., and Cox, R.H. (1986). Baroreceptor control of heart rate in chickens (*Gallus domesticus*). *Am. J. Vet. Res.* **47**, 293.
- Banzett, R.B., Butler, J.P., Nations, C.S., Barnas, G.M., Lehr, J.L., and Jones, J.H. (1987). Inspiratory aerodynamic valving in goose lungs depends on gas density and velocity. *Respir. Physiol.* **70**(3), 287–300.
- Banzett, R.B., and Lehr, J.L. (1982). Gas exchange during high-frequency ventilation of the chicken. *J. Appl. Physiol.* **53**(6), 1418–1422.
- Banzett, R.B., Nations, C.S., Wang, N., Fredberg, J.J., and Butler, J.P. (1991). Pressure profiles show features essential to aerodynamic valving in geese. *Respir. Physiol.* **84**(3), 295–309.
- Bardo, M.T., and Hughes, R.A. (1978). Brief communication. Shock-elicited flight response in chickens as an index of morphine analgesia. *Pharmacol. Biochem. Behav.* **9**(1), 147–149.
- Blogg, S.L., Townsend, P.P., Butler, P.J., and Taylor, E.W. (1998). A method of anaesthesia and post-operative care for experimental procedures in avian species. *Anim. Technol.* **49**(2), 101–109.
- Boxenbaum, H. (1982). Interspecies scaling, allometry, physiological time, and the ground plan of pharmacokinetics. *J. Pharmacokinetic. Biopharm.* **10**(2), 201–227.
- Brown, R., Kovacs, C., Butler, J., Wang, N., Lehr, J., and Banzett, R. (1995). The avian lung: Is there an aerodynamic expiratory valve? *J. Exp. Biol.* **198**(Pt 11), 2349–2357.
- Brown, R.E., Brain, J.D., and Wang, N. (1997). The avian respiratory system: A unique model for studies of respiratory toxicosis and for monitoring air quality. *Environ. Health Perspect.* **105**(2), 188–200.
- Burger, R.E., and Lorenz, F.W. (1960). Artificial respiration in birds by unidirectional air flow. *Poult. Sci.* **39**, 236–237.
- Burger, R.E., Meyer, M., Graf, W., and Scheid, P. (1979). Gas exchange in the parabronchial lung of birds: Experiments in unidirectionally ventilated ducks. *Respir. Physiol.* **36**(1), 19–37.
- Butler, J.P., Banzett, R.B., and Fredberg, J.J. (1988). Inspiratory valving in avian bronchi: Aerodynamic considerations. *Respir. Physiol.* **72**(2), 241–255.
- Butler, P.J. (1988). The exercise response and the “classical” diving response during natural submersion in birds and mammals. *Can. J. Zool.* **66**, 29–39.
- Carp, N.Z., Saputelli, J., Halbherr, T.C., et al. (1991). A technique for liver biopsy performed in Pekin ducks using anesthesia with Telazol. *Lab. Anim. Sci.* **41**, 474–475.
- Cherdchanpipat, S., Shupchukum, K., Pongpichayasiri, K., and Kalpravidh, M. (1989). Dose-response study of medetomidine in birds. *Thai J. Vet. Med.* **19**(2), 65–73.
- Christensen, J., Fosse, R.T., Halvorsen, O.J., and Morild, I. (1987). Comparison of various anesthetic regimens in the domestic fowl. *Am. J. Vet. Res.* **48**(11), 1649–1657.
- Clippinger, T.L., Platt, S.R., Bennett, R.A., and Chrisman, C.L. (2000). Electrodiagnostic evaluation of peripheral nerve function in rheas and barred owls. *Am. J. Vet. Res.* **61**(4), 469–472.
- Clyde, V.L., and Paul-Murphy, J. (1999). Avian analgesia. In “Kirk’s Current Veterinary Therapy XIII—Small Animal Practice.” (J.D. Bonagura, ed.), W.B. Saunders, Philadelphia, PA.
- Cooper, J.E. (2002). “Birds of Prey: Health and Disease.” Blackwell Science, Oxford.
- Curro, T.G., Brunson, D.B., and Paul-Murphy, J. (1994). Determination of the ED50 of isoflurane and evaluation of the isoflurane-sparing effect of butorphanol in cockatoos (*Cacatua* spp.). *Vet. Surg.* **23**(5), 429–433.
- Degernes, L.A., Kreeger, T.J., Mandsager, R., and Redig, P.T. (1988). Ketamine–xylazine anesthesia in red-tailed hawks with antagonism by yohimbine. *J. Wildl. Dis.* **24**(2), 322–326.
- Dorrestein, G.M. (1991). The pharmacokinetics of avian therapeutics. *Vet. Clin. North Am. Small Anim. Pract.* **21**(6), 1241–1264.
- Dorrestein, G.M., and van Miert, A.S. (1988). Pharmacotherapeutic aspects of medication of birds. *J. Vet. Pharmacol. Ther.* **11**(1), 33–44.
- Duncker, H.-R. (1972). Structure of avian lungs. *Respir. Physiol.* **14**, 44–63.
- Edling, T.M., Degernes, L.A., Flammer, K., and Horne, W.A. (2001). Capnographic monitoring of anesthetized African grey parrots receiving intermittent positive pressure ventilation. *J. Am. Vet. Med. Assoc.* **219**(12), 1714–1718.
- Fedde, M.R. (1978). Drugs used for avian anesthesia: A review. *Poult. Sci.* **57**(5), 1376–1399.
- Fedde, M.R. (1980). Structure and gas-flow pattern in the avian respiratory system. *Poult. Sci.* **59**, 2642.
- Fedde, M.R., Burger, R.E., and Kitchell, R.L. (1964). Electromyographic studies of the effects of bodily position and anesthesia on the activity of the respiratory muscles of the domestic cock. *Poult. Sci.* **43**, 839–846.
- Fedde, M.R., Nelson, P.I., and Kuhlmann, W.D. (2002). Ventilatory sensitivity to changes in inspired and arterial carbon dioxide partial pressures in the chicken. *Poult. Sci.* **81**(6), 869–876.
- Fitzgerald, G., and Cooper, J.E. (1990). Preliminary studies on the use of propofol in the domestic pigeon (*Columba livia*). *Res. Vet. Sci.* **49**(3), 334–338.
- Fowler, M.E., and Miller, R.E. (eds.). (2003). “Zoo and Wild Animal Medicine.” W.B. Saunders, Philadelphia, PA.
- France, C.P., and Woods, J.H. (1987). Morphine, saline and naltrexone discrimination in morphine-treated pigeons. *J. Pharmacol. Exp. Ther.* **242**(1), 195–202.
- Franchetti, D.R., and Klide, A.M. (1978). Restraint and anesthesia. In “Zoo and Wild Animal Medicine.” (M.E. Fowler, ed.), pp 359–364. W.B. Saunders, Philadelphia, PA.
- Gleeson, M., and Molony, V. (1989). Control of breathing. In “Form and Function in Birds.” (A.S. King and J. McLelland, eds.), Vol. 4, pp 439–484. Academic Press, London.

- Goelz, M.F., Hahn, A.W., and Kelley, S.T. (1990). Effects of halothane and isoflurane on mean arterial blood pressure, heart rate, and respiratory rate in adult Pekin ducks. *Am. J. Vet. Res.* **51**(3), 458–460.
- Greenlees, K.J., Clutton, R.E., Larsen, C.T., and Eyre, P. (1990). Effect of halothane, isoflurane, and pentobarbital anesthesia on myocardial irritability in chickens. *Am. J. Vet. Res.* **51**(5), 757–758.
- Grubb, B.R. (1983). Allometric relations of cardiovascular function in birds. *Am. J. Physiol.* **245**, H567.
- Harrison, G.J. (1991). Pre-anesthetic fasting recommended. *J. Assoc. Avian Vet.* **5**, 126.
- Hawkins, M.G., Wright, B.D., Pascoe, P.J., Kass, P.H., Maxwell, L.K., and Tell, L.A. (2003). Pharmacokinetics and anesthetic and cardiopulmonary effects of propofol in red-tailed hawks (*Buteo jamaicensis*) and great horned owls (*Bubo virginianus*). *Am. J. Vet. Res.* **64**(6), 677–683.
- Hellebrekers, L.J., Sap, R., and van Wandelen, R.M. (1991). Spontaneous ventilation versus intermittent positive pressure ventilation in birds. "Fourth International Congress of Veterinary Anaesthesia." The Netherlands, Utrecht, p 81.
- Hempleman, S.C., Adamson, T.P., Begay, R.S., and Solomon, I.C. (2003). CO₂ transduction in avian intrapulmonary chemoreceptors is critically dependent on transmembrane Na⁺/H⁺ exchange. *Am. J. Physiol. Regul. Integr. Comp. Physiol.* **284**(6), R1551–R1559.
- Hempleman, S.C., and Burger, R.E. (1985). Comparison of intrapulmonary chemoreceptor response to PCO₂ in the duck and chicken. *Respir. Physiol.* **61**(2), 179–184.
- Hempleman, S.C., Rodriguez, T.A., Bhagat, Y.A., and Begay, R.S. (2000). Benzolamide, acetazolamide, and signal transduction in avian intrapulmonary chemoreceptors. *Am. J. Physiol. Regul. Integr. Comp. Physiol.* **279**(6), R1988–R1995.
- Herling, S., Valentino, R.J., Solomon, R.E., and Woods, J.H. (1984). Narcotic discrimination in pigeons: Antagonism by naltrexone. *Eur. J. Pharmacol.* **105**(1–2), 137–142.
- Hocking, P.M., Robertson, G.W., and Gentle, M.J. (2005). Effects of non-steroidal anti-inflammatory drugs on pain-related behaviour in a model of articular pain in the domestic fowl. *Res. Vet. Sci.* **78**(1), 69–75.
- Hoppes, S., Flammer, K., Hoersch, L., Papich, M., and Paul-Murphy, J. (2003). Disposition and analgesic effects of fentanyl in white cockatoos (*Cacatua alba*). *J. Avian Med. Surg.* **17**(3), 124–130.
- Hughes, R.A. (1990). Codeine analgesic and morphine hyperalgesic effects on thermal nociception in domestic fowl. *Pharmacol. Biochem. Behav.* **35**(3), 567–570.
- Jaensch, S.M., Cullen, L., and Raidal, S.R. (2002). Air sac functional anatomy of the sulphur-crested cockatoo (*Cacatua galerita*) during isoflurane anesthesia. *J. Avian Med. Surg.* **16**(1), 2–9.
- Jones, D.R., Bryan, R.M., West, N.H., Lord, R.H., and Clark, B. (1979). Regional distribution of blood flow during diving in the duck (*Anas platyrhynchos*). *Can. J. Zool.* **57**, 995.
- Jones, D.R., Furilla, R.A., Heieis, M.R.A., Gabbott, G.R.J., and Smith, F.M. (1988). Forced and voluntary diving in ducks: Cardiovascular adjustments and their control. *Can. J. Zool.* **66**, 75.
- Jones, J.H., Effmann, E.L., and Schmidt-Nielsen, K. (1981). Control of air flow in bird lungs: Radiographic studies. *Respir. Physiol.* **45**(2), 121–131.
- Kalpravidh, M. (1991). Use of medetomidine as a preanaesthetic in birds. *J. Vet. Anaesth.* Issue: Special Supplement ISSN: 0950-7817 Proceedings of the 4th International Congress of Veterinary Anaesthesia, Utrecht, Netherlands, 25–31 August 1991, 245–248.
- Keene, B.W., and Flammer, K. (1991). ECG of the month. *J. Am. Vet. Med. Assoc.* **198**(3), 408–409.
- Kilgore, D.L., Jr., Faraci, F.M., and Fedde, M.R. (1985). Ventilatory and intrapulmonary chemoreceptor sensitivity to CO₂ in the burrowing owl. *Respir. Physiol.* **62**(3), 325–339.
- King, A.S., and Payne, D.C. (1964). Normal breathing and the effects of posture in *Gallus domesticus*. *J. Physiol. (London)* **174**, 340–347.
- Kisch, B. (1951). The electrocardiogram of birds (chicken, duck, pigeon). *Exp. Med. Surg.* **9**, 103.
- Klide, A.M. (1973). Avian anesthesia. *Vet. Clin. North Am.* **3**(2), 175–186.
- Klika, E., Scheuermann, D.W., De Groot-Lasseel, M.H., Bazantova, I., and Switka, A. (1997). Anchoring and support system of pulmonary gas-exchange tissue in four bird species. *Acta Anat. (Basel)* **159**(1), 30–41.
- Klika, E., Scheuermann, D.W., De Groot-Lasseel, M.H., Bazantova, I., and Switka, A. (1998). An SEM and TEM study of the transition of the bronchus to the parabronchus in quail (*Coturnix coturnix*). *Anat. Anz.* **180**(4), 289–297.
- Kollias, G.V. (2006). Cornell University, Ithaca, NY (personal communication).
- Korbel, R. (1998). Comparative investigations on inhalation anesthesia with isoflurane (Forene) and sevoflurane (SEVOrane) in racing pigeons (*Columba livia Gmel.*, 1789, var. *domestica*) and presentation of a reference anesthesia protocol for birds. *Tierarztl. Prax. Ausg. K Klientiere Heimtiere* **26**(3), 211–223.
- Korbel, R., Burike, S., Erhardt, W., Henke, J., and Petrowicz, O. (1996). Effect of nitrous oxide application in racing pigeons (*Columba livia Gmel.*, 1789, var. *dom.*): A study using the airsac perfusion technique. *Israel J. Vet. Med.* **51**(3–4), 133–139.
- Kueth, D.O. (1988). Fluid mechanical valving of air flow in bird lungs. *J. Exp. Biol.* **136**, 1–12.
- Langlois, I., Harvey, R.C., Jones, M.P., and Schumacher, J. (2003). Cardiopulmonary and anesthetic effects of isoflurane and propofol in Hispaniolan parrots (*Amazona ventralis*). *J. Avian Med. Surg.* **17**(1), 4–10.
- Leander, J.D. (1983). Opioid agonist and antagonist behavioural effects of buprenorphine. *Br. J. Pharmacol.* **78**(4), 607–615.
- Leander, J.D., and McMillan, D.E. (1977). Meperidine effects on schedule-controlled responding. *J. Pharmacol. Exp. Ther.* **201**(2), 434–443.
- Le Maho, Y., Karmann, H., Briot, D., Handrich, Y., Robin, J.P., Mioskowski, E., Chereil, Y., and Farni, J. (1992). Stress in birds due to routine handling and a technique to avoid it. *Am. J. Physiol.* **263**(4 Pt 2), R775–R781.
- Leonardi, F., Razza, P.D., Calzolari, A., Venzi, C., Zavattiero, S., Risio, L.D., and Zanichelli, S. (2004). Comparison of three anaesthesiological protocols for anaesthesia of psittacids. *Ann. della Facolta Med. Vet. Univ. Parma* **24**, 151–171.
- Loerzel, S.M., Smith, P.J., Howe, A., and Samuelson, D.A. (2002). Vecuronium bromide, phenylephrine and atropine combinations as mydriatics in juvenile double-crested cormorants (*Phalacrocorax auritus*). *Vet. Ophthalmol.* **5**(3), 149–154.
- Ludders, J.W. (1992). Minimal anesthetic concentration and cardiopulmonary dose-response of halothane in ducks. *Vet. Surg.* **21**(4), 319–324.
- Ludders, J.W. (2001). Another reader opposing thoracic compression for avian euthanasia. *J. Am. Vet. Med. Assoc.* **218**(11), 1721.
- Ludders, J.W., and Matthews, N. (1996). Avian anesthesia. In "Lumb and Jones' Veterinary Anesthesia." (J. Thurmon, J. Benson, and W. Tranquilli, eds.), pp 645–669. Williams & Wilkins, Baltimore, MD.
- Ludders, J.W., Mitchell, G.S., and Rode, J. (1990). Minimal anesthetic concentration and cardiopulmonary dose response of isoflurane in ducks. *Vet. Surg.* **19**(4), 304–307.
- Ludders, J.W., Mitchell, G.S., and Schaefer, S.L. (1988). Minimum anesthetic dose and cardiopulmonary dose response for halothane in chickens. *Am. J. Vet. Res.* **49**(6), 929–932.
- Ludders, J.W., Rode, J., and Mitchell, G.S. (1989a). Isoflurane anesthesia in sandhill cranes (*Grus canadensis*): Minimal anesthetic concentration and cardiopulmonary dose-response during spontaneous and controlled breathing. *Anesth. Analg.* **68**(4), 511–516.
- Ludders, J.W., Rode, J., Mitchell, G.S., and Nordheim, E.V. (1989b). Effects of ketamine, xylazine, and a combination of ketamine and xylazine in Pekin ducks. *Am. J. Vet. Res.* **50**(2), 245–249.
- Lukasik, V.M., Gentz, E.J., Erb, H.N., Ludders, J.W., and Scarlett, J.M. (1997). Cardiopulmonary effects of propofol anesthesia in chickens (*Gallus gallus*). *J. Assoc. Avian Vet.* **11**, 93–97.

- Lumeij, J.T., and Deenik, J.W. (2003). Medetomidine–ketamine and diazepam–ketamine anesthesia in racing pigeons (*Columba livia domestica*): A comparative study. *J. Avian Med. Surg.* **17**(4), 191–196.
- Lumeij, J.T., and Stokhof, A.A. (1985). Electrocardiogram of the racing pigeon (*Columba livia domestica*). *Res. Vet. Sci.* **38**(3), 275–278.
- Machin, K.L., and Caulkett, N.A. (1998). Cardiopulmonary effects of propofol and a medetomidine–midazolam–ketamine combination in mallard ducks. *Am. J. Vet. Res.* **59**(5), 598–602.
- Machin, K.L., Caulkett, N.A. (1999). Cardiopulmonary effect of propofol infusion in canvasback ducks (*Aythya valisineria*). *J. Avian Med. Surg.* **13**, 167–172.
- Machin, K.L., and Caulkett, N.A. (2000). Evaluation of isoflurane and propofol anesthesia for intraabdominal transmitter placement in nesting female canvasback ducks. *J. Wildl. Dis.* **36**(2), 324–334.
- Magnussen, H., Willmer, H., and Scheid, P. (1976). Gas exchange in air sacs: Contribution to respiratory gas exchange in ducks. *Respir. Physiol.* **26**, 129.
- Mama, K.R., Phillips, L.G., Jr., and Pascoe, P.J. (1996). Use of propofol for induction and maintenance of anesthesia in a barn owl (*Tyto alba*) undergoing tracheal resection. *J. Zoo Wildl. Med.* **27**(3), 397–401.
- Mansour, A., Khachaturian, H., Lewis, M.E., Akil, H., and Watson, S.J. (1988). Anatomy of CNS opioid receptors. *Trends Neurosci.* **11**(7), 308–314.
- McDonald, S. (1989). Common anesthetic dosages for use in psittacine birds. *J. Assoc. Avian Vet.* **3**, 186.
- McGrath, C.J., Lee, J.C., and Campbell, V.L. (1984). Dose-response anesthetic effects of ketamine in the chicken. *Am. J. Vet. Res.* **45**(3), 531–534.
- McLelland, J. (1989a). Larynx and trachea. In “Form and Function in Birds.” (A.S. King and J. McLelland, eds.), Vol. 4, pp 69–103. Academic Press, London.
- McLelland, J. (1989b). Anatomy of the lungs and air sacs. In “Form and Function in Birds.” (A.S. King and J. McLelland, eds.), Vol. 4, pp 221–279. Academic Press, London.
- Mikaelian, J. (1991). Intravenously administered propofol for anesthesia of the common buzzard (*Buteo buteo*), the tawny owl (*Strix aluco*), and the barn owl (*Tyto alba*). Proceedings of the First Conference of the European Committee of the Association of Avian Veterinarians, Vienna, Austria.
- Mohammad, F.K., Amin, A.J., and Basher, H.A. (1997). Medetomidine sedation and medetomidine–ketamine anaesthesia in chickens. *Iraqi J. Vet. Sci.* **10**(1), 1–7.
- Molony, V. (1974). Classification of vagal afferents firing in phase with breathing in *Gallus domesticus*. *Respir. Physiol.* **22**, 57.
- Mulcahy, D.M., Tuomi, P., and Larsen, S.R. (2003). Differential mortality for male spectacled eiders (*Somateria fischeri*) and king eiders (*Somateria spectabilis*) subsequent to anesthesia with propofol, bupivacaine, and ketoprofen. *J. Avian Med. Surg.* **17**(3), 117–123.
- Naganobu, K., Fujisawa, Y., Ohde, H., Matsuda, Y., Sonoda, T., and Ogawa, H. (2000). Determination of the minimum anesthetic concentration and cardiovascular dose response for sevoflurane in chickens during controlled ventilation. *Vet. Surg.* **29**(1), 102–105.
- Naganobu, K., and Hagio, M. (2000). Dose-related cardiovascular effects of isoflurane in chickens during controlled ventilation. *J. Vet. Med. Sci.* **62**, 435–437.
- Naganobu, K., Hagio, M., Sonoda, T., Kagawa, K., and Mammoto, T. (2001). Arrhythmogenic effect of hypercapnia in ducks anesthetized with halothane. *Am. J. Vet. Res.* **62**(1), 127–129.
- Naganobu, K., Ise, K., Miyamoto, T., and Hagio, M. (2003). Sevoflurane anaesthesia in chickens during spontaneous and controlled ventilation. *Vet. Rec.* **152**(2), 45–48.
- Nicholson, A., and Ilkiw, J.E. (1992). Neuromuscular and cardiovascular effects of atracurium in isoflurane-anesthetized chickens. *Am. J. Vet. Res.* **53**(12), 2337–2342.
- Nilson, P.C., Teramitsu, I., and White, S.A. (2005). Caudal thoracic air sac cannulation in zebra finches for isoflurane anesthesia. *J. Neurosci. Methods* **143**(2), 107–115.
- Oaks, J.L., Gilbert, M., Virani, M.Z., Watson, R.T., Meteyer, C.U., Rideout, B.A., Shivaprasad, H.L., Ahmed, S., Chaudhry, M.J., Arshad, M., Mahmood, S., Ali, A., and Khan, A.A. (2004). Diclofenac residues as the cause of vulture population decline in Pakistan. *Nature* **427**(6975), 630–633.
- Osborne, J.L., and Mitchell, G.S. (1977). Regulation of arterial PCO₂ during inhalation of CO₂ in chickens. *Respir. Physiol.* **31**(3), 357–364.
- Osborne, J.L., and Mitchell, G.S. (1978). Ventilatory responses during arterial homeostasis of PCO₂ at low levels of inspired carbon dioxide. In “Respiratory Function in Birds, Adult and Embryonic.” (J. Piiper, ed.), pp 168–174. Springer-Verlag, Berlin.
- Paul-Murphy, J., and Ludders, J.W. (2001). Avian analgesia. *Vet. Clin. North Am. Exot. Anim. Pract.* **4**(1), 35–45, vi.
- Paul-Murphy, J.R., Brunson, D.B., and Miletic, V. (1999). Analgesic effects of butorphanol and buprenorphine in conscious African grey parrots (*Psittacus erithacus erithacus* and *Psittacus erithacus timneh*). *Am. J. Vet. Res.* **60**(10), 1218–1221.
- Pettifer, G.R., Cornick-Seahorn, J., Smith, J.A., Hosgood, G., and Tully, T.N. (2002). The comparative cardiopulmonary effects of spontaneous and controlled ventilation by using the Hallowell EMC Anesthesia WorkStation in Hispaniolan Amazon parrots (*Amazona ventralis*). *J. Avian Med. Surg.* **16**(4), 268–276.
- Piiper, J., Drees, F., and Scheid, P. (1970). Gas exchange in the domestic fowl during spontaneous breathing and artificial ventilation. *Respir. Physiol.* **9**, 234.
- Piiper, J., and Scheid, P. (1973). Gas exchange in avian lungs: Models and experimental evidence. In “Comparative Physiology.” (L. Bolis, K. Schmidt-Nielsen, and M.S.H.P., eds.), North-Holland, Amsterdam.
- Pizarro, J., Ludders, J.W., Douse, M.A., and Mitchell, G.S. (1990). Halothane effects on ventilatory responses to changes in intrapulmonary CO₂ in geese. *Respir. Physiol.* **82**(3), 337–347.
- Pollock, C.G., Schumacher, J., Orosz, S.E., and Ramsay, E.C. (2001). Sedative effects of medetomidine in pigeons (*Columba livia*). *J. Avian Med. Surg.* **15**(2), 95–100.
- Powell, F.L., and Hopkins, S.R. (2004). Comparative physiology of lung complexity: Implications for gas exchange. *News Physiol. Sci.* **19**, 55–60.
- Powell, F.L., and Scheid, P. (1989). Physiology of gas exchange in the avian respiratory system. In “Form and Function in Birds.” (A.S. King and J. McLelland, eds.), Vol. 4, pp 393–437. Academic Press, London.
- Quasha, A.L., Eger, E.I. II, and Tinker, J.H. (1980). Determinations and applications of MAC. *Anesthesiology* **53**, 315–334.
- Rager, D.R., and Gallup, G.G., Jr. (1986). Apparent analgesic effects of morphine in chickens may be confounded by motor deficits. *Physiol. Behav.* **37**(2), 269–272.
- Ramer, J.C., Paul-Murphy, J., Brunson, D., and Murphy, C.J. (1996). Effects of mydriatic agents in cockatoos, African gray parrots, and blue-fronted Amazon parrots. *J. Am. Vet. Med. Assoc.* **208**(2), 227–230.
- Redig, P.T., Larson, A.A., and Duke, G.E. (1984). Response of great horned owls given the optical isomers of ketamine. *Am. J. Vet. Res.* **45**(1), 125–127.
- Regan, M.J., and Eger, E.I. II. (1967). Effect of hypothermia in dogs on anesthetizing and apneic doses of inhalation agents. Determination of the anesthetic index (Apnea/MAC). *Anesthesiology* **28**(4), 689–700.
- Rembert, M.S., Smith, J.A., Hosgood, G., Marks, S.L., and Tully, T.N., Jr. (2001). Comparison of traditional thermal support devices with the forced-air warmer system in anesthetized Hispaniolan Amazon parrots (*Amazona ventralis*). *J. Avian Med. Surg.* **15**(3), 187–193.
- Reynold, W.T. (1983). Unusual anesthetic complication in a pelican. *Vet. Rec.* **113**, 204.
- Ritchie, B.W., Harrison, G.J., and Harrison, L.R. (1994). “Avian Medicine: Principles and Application.” Wingers Publishing, Lake Worth, FL.
- Roberson, D.W., Alosi, J.A., Messana, E.P., Nedder, A.P., and Cotanche, D.A. (2000). Endotracheal isoflurane anesthesia for chick auditory surgery. *Hear. Res.* **141**, 165–168.
- Rode, J.A., Bartholow, S., and Ludders, J.W. (1990). Ventilation through an air sac cannula during tracheal obstruction in ducks. *J. Assoc. Avian Vet.* **4**, 98.

- Salerno, A., and van Tienhoven, A. (1976). The effect of ketamine on heart rate, respiration rate and EEG of white leghorn hens. *Comp. Biochem. Physiol. C* **55**(1), 69–75.
- Samour, J.H., Jones, D.M., Knight, J.A., and Howlett, J.C. (1984). Comparative studies of the use of some injectable anaesthetic agents in birds. *Vet. Rec.* **115**(1), 6–11.
- Sandmeier, P. (2000). Evaluation of medetomidine for short-term immobilization of domestic pigeons (*Columba livia*) and Amazon parrots (*Amazona* species). *J. Avian Med. Surg.* **14**(1), 8–14.
- Scheid, P. (1979). Mechanisms of gas exchange in bird lungs. *Rev. Physiol. Biochem. Pharmacol.* **86**, 138.
- Scheid, P., and Piiper, J. (1970). Analysis of gas exchange in the avian lung: Theory and experiments in the domestic fowl. *Respir. Physiol.* **9**, 246.
- Scheid, P., and Piiper, J. (1989a). Respiratory mechanics and air flow in birds. In "Form and Function in Birds," Vol. 4, pp 369–391. Academic Press, London.
- Scheid, P., and Piiper, J. (1989b). Aerodynamic valving in the avian lung. *Acta Anaesthesiol. Scand. Suppl.* **90**, 28–31.
- Schmidt-Nielsen, K. (1991). "Scaling: Why Is Animal Size So Important?" Cambridge University Press, Cambridge.
- Schmitt, P.M., Gobel, T., and Trautvetter, E. (1998). Evaluation of pulse oximetry as a monitoring method in avian anesthesia. *J. Avian Med. Surg.* **12**(2), 91–99.
- Schumacher, J., Citino, S.B., Hernandez, K., Hutt, J., and Dixon, B. (1997). Cardiopulmonary and anesthetic effects of propofol in wild turkeys. *Am. J. Vet. Res.* **58**(9), 1014–1017.
- Sedgwick, C.J. (1980). Anesthesia of caged birds. In "Current Veterinary Therapy VII." (R. Kirk, ed.), pp 653–656. W.B. Saunders, Philadelphia, PA.
- Sedgwick, C.J., and Pokras, M.A. (1988). Extrapolating rational drug doses and treatment periods by allometric scaling. 55th Annual Meeting of the American Animal Hospital Association, Washington, DC.
- Shoemaker, J.M., and Hempleman, S.C. (2001). Avian intrapulmonary chemoreceptor discharge rate is increased by anion exchange blocker 'DIDS'. *Respir. Physiol.* **128**(2), 195–204.
- Sinn, L.C. (1997). Anesthesiology. In "Avian Medicine: Principles and Application." (D.W. Zantop, ed.), pp 589–599. Wingers Publishing, Inc., Lake Worth, FL.
- Steffey, E.P., and Howland, D., Jr. (1977). Isoflurane potency in the dog and cat. *Am. J. Vet. Res.* **38**(11), 1833–1836.
- Steffey, E.P., and Howland, D., Jr. (1978). Potency of enflurane in dogs: Comparison with halothane and isoflurane. *Am. J. Vet. Res.* **39**(4), 573–577.
- Steffey, E.P., Howland, D., Jr., Giri, S., and Eger, E.I. II. (1977). Enflurane, halothane, and isoflurane potency in horses. *Am. J. Vet. Res.* **38**(7), 1037–1039.
- Sturkie, P.D. (1986a). Heart: Contraction, conduction, and electrocardiography. In "Avian Physiology." (P.D. Sturkie, ed.), pp 167–190. Springer-Verlag, New York.
- Sturkie, P.D. (1986b). Heart and circulation: Anatomy, hemodynamics, blood pressure, blood flow. In "Avian Physiology." (P.D. Sturkie, ed.), pp 130–166. Springer-Verlag, New York.
- Valverde, A., Honeyman, V.L., Dyson, D.H., and Valliant, A.E. (1990). Determination of a sedative dose and influence of midazolam on cardiopulmonary function in Canada geese. *Am. J. Vet. Res.* **51**(7), 1071–1074.
- Vestergaard, K.S., and Santora, G.S. (1999). Relationships between leg disorders and changes in the behaviour of broiler chickens. *Vet. Rec.* **144**, 205–209.
- Wang, N., Banzett, R.B., Butler, J.P., and Fredberg, J.J. (1988). Bird lung models show that convective inertia effects inspiratory aerodynamic valving. *Respir. Physiol.* **73**(1), 111–124.
- Whittow, G.C., and Ossorio, N. (1970). A new technic for anesthetizing birds. *Lab. Anim. Care* **20**(4 Pt 1), 651–656.
- Wijnberg, I.D., Lagerweij, E., and Zwart, P. (1991). Inhalation anaesthesia in birds through the abdominal air sac, using a unidirectional, continuous flow. Proceedings of the 4th International Congress of Veterinary Anaesthesia, The Netherlands, Utrecht, p. 80.
- Woakes, A.J. (1988). Metabolism in diving birds: Studies in the laboratory and the field. *Can. J. Zool.* **66**, 138.
- Zenoble, R.D. (1981). Electrocardiography in the parakeet and parrot. *Compend. Contin. Educ.* **3**, 711.
- Zenoble, R.D., and Graham, D.L. (1979). Electrocardiography of the parakeet, parrot and owl. Annual Meeting of the American Association of Zoo Veterinarians, American Association of Zoo Veterinarians.

Anesthesia and Analgesia in Reptiles

Dorcas P. O'Rourke and Audrey L. Jenkins

I. Introduction	501
II. General Considerations	501
III. Preanesthetic Evaluation and Preparation	503
IV. Anesthetic Techniques	503
V. Physical Restraint and Handling	503
VI. Anesthesia of Venomous Species	503
VII. Routes of Drug Administration	505
VIII. Inhalant Anesthesia	505
IX. Injectable Anesthesia	506
X. Local/Regional Anesthesia	506
XI. Total Intravenous Anesthesia	506
XII. Neuromuscular Blocking Agents	506
XIII. Preanesthesia	506
XIV. Anesthetic Induction	507
XV. Anesthetic Maintenance	507
XVI. Monitoring	508
XVII. Recovery	508
XVIII. Pain Management/Analgesia	508
XIX. Prolonged/Repeated Anesthesia	508
A. Field Anesthesia	508
References	509

I. INTRODUCTION

Reptiles are not typically considered traditional laboratory animals; however, they are frequently subjects of both basic science and ecological research. Class Reptilia is comprised of four orders, three of which are commonly encountered in a research setting: Squamata (snakes and lizards), Chelonia (turtles), and Crocodylia (crocodilians).

II. GENERAL CONSIDERATIONS

Unlike mammals and birds, reptiles are poikilothermic; they rely on warm ambient temperatures to maintain normal metabolic processes. With very few exceptions, such as female pythons shivering to raise body temperature during egg incubation, reptiles require an external heat source and the ability to move into and away from the heat as needed. Maintaining a

TABLE 19-1
NORMAL TEMPERATURE RANGES

	Temperature	RH (%)
Snakes		
Boa constrictor (<i>Boa constrictor</i>)	28–34°C (82–93°F)	50–70
Corn snake (<i>Elaphe guttata</i>)	25–30°C (77–86°F)	–
King snake (<i>Lampropeltis getulus</i>)	23–30°C (73–86°F)	50–70
Chelonians		
Common box tortoise (<i>Terrapene carolina</i>)	20–27°C (68–81°F)	60–80
Red-eared slider (<i>Trachemys scripta elegans</i>)	22–30°C (72–86°F)	80–90
Lizards		
Green iguana (textitIguana iguana)	29–38°C (85–100°F)	60–80
Crocodilian		
American alligator (<i>Alligator mississippiensis</i>)	30–35°C (86–95°F)	–

Source: Carpenter et al. (2001).

reptile at suboptimal temperatures during and after anesthesia predisposes the animal to immune suppression and subsequent infection. If the environmental temperature is too low, induction can be slow and recovery times are prolonged (Arena and Richardson, 1990). Furthermore, if room temperature during anesthesia is cooler than during recovery, lipid-soluble agents may be released from body fat and cause anesthetic relapse (Bennett, 1991). Elevation of environmental temperature also causes increased oxygen demand, and reptiles recovering from anesthesia may be unable to generate a compensatory increase in respiration due to anesthetic-induced respiratory depression (Schumacher and Yelen, 2006). Temperature preference ranges have been published for many reptiles, and there can be considerable variation among species (Table 19-1). If information is unavailable for a particular species, a range of 26–32°C is generally acceptable (Page, 1993; Schaeffer, 1994).

Anatomically, the reptilian glottis is positioned more rostrally than the mammalian laryngeal opening and is typically easier to visualize. In snakes, the glottis lies immediately behind the tongue sheath; this anterior location allows the snake to continue breathing while slowly swallowing a large prey (Fig. 19-1). The glottis is located at the base of the fleshy tongue in turtles and many lizard species. Crocodilians have a large basihyal valve (epiglottis), which forms a seal with the soft palate and permits them to submerge while holding prey in their mouths. This adaptation prevents easy visualization of the glottis, and a laryngoscope is needed to depress the basihyal valve and expose the glottis (Schaeffer, 1997) (Fig. 19-2). The dilator glottis muscle opens the glottis during respiration (Bennett, 1991); otherwise, it is tightly closed and difficult to intubate.

Tracheal structure varies among the reptile orders. Snakes and lizards have incomplete tracheal rings. Conversely, turtles and crocodilians have complete tracheal rings, which are susceptible to damage by overinflated cuffed endotracheal tubes.



Fig. 19-1 The snake glottis is located behind the tongue sheath and is easily visualized.



Fig. 19-2 A laryngoscope can be used to depress the basihyal valve and access the glottis in crocodilians.

With the exception of crocodilians, reptile lungs are simple, endothelium-lined sacs. In some species, the lungs terminate in air sacs, which may serve as air reservoirs, function in defense (by making the animal look larger), or play a role in maintaining buoyancy when swimming. Paired lungs are present in crocodilians, turtles, and lizards. Most snakes have a single, functional right lung and vestigial left lung. Care must be exercised when providing assisted ventilation to reptiles, as the lungs and air sacs are delicate and easily damaged by overinflation (Jacobson, 1993).

A true muscular diaphragm is lacking in reptiles, and ventilation occurs as a result of movement of the intercostal, abdominal, and trunk muscles. The ribs in turtles are fused to the carapace (bony shell); therefore, turtle intercostal muscles cannot be moved. Turtles must use their limbs and pelvic girdle to assist in ventilation (Bennett, 1991). Turtle lungs are situated dorsally, immediately below the carapace; therefore, placing a turtle in dorsal recumbency during anesthesia can result in compression of the lungs by abdominal viscera. If an anesthetized turtle is placed in dorsal recumbency, assisted

ventilation (approximately 4–6 breaths/min) should be provided (Bennett, 1991; Millichamp, 1988).

The three factors that control reptile respiration are hypercapnia, hypoxemia, and environmental temperature. Low oxygen concentration stimulates respiration in reptiles. Many reptiles increase tidal volume in response to elevated environmental temperatures and elevated carbon dioxide levels, while low oxygen concentrations cause increase in respiratory rate. If a reptile is recovered from anesthesia using oxygen supplementation, the oxygen-rich environment may result in decreases in both respiratory rate and tidal volume, thereby hindering the recovery effort (Schumacher and Yelen, 2006; Wang et al., 1998).

III. PREANESTHETIC EVALUATION AND PREPARATION

Reptiles should be fasted prior to anesthesia if they have recently eaten. Gastrointestinal transit time is variable from species to species, and animals with slow transit times may require fasting for several days (Arena and Richardson, 1990; Millichamp, 1988). A minimum fast of 24–48 hours prior to anesthesia has been recommended (Page, 1993). Preanesthetic evaluation should include an accurate weight, baseline heart rate and respiratory rate, and a thorough physical examination. Hydration status should be assessed, and any fluid deficits corrected. Daily water requirement for most reptiles is approximately 30 ml/kg/day (Schumacher, 2000). A complete blood count (CBC) and plasma biochemistry values are often useful; however, animal-size limitations and lack of published normal values for many species may preclude the use of these tests. If possible, a packed cell volume (PCV), total protein (TP), and blood glucose levels should be obtained (Schumacher and Yelen, 2006). Normal values for selected species are in Table 19-2.

IV. ANESTHETIC TECHNIQUES

Reptiles can be anesthetized with either inhalant or injectable agents. Inhalants are preferred because of the relatively rapid induction and recovery times. They also allow better control of anesthetic depth. The disadvantages of inhalants include the need for precision vaporizers, oxygen sources, and endotracheal intubation.

Injectable anesthetics can be used in reptiles. For agents delivered via the IM route, the advantages include ease of administration, especially in large or potentially dangerous species. Disadvantages of most injectables include comparatively long induction and recovery times when compared to inhalants. With the exception of propofol, which requires IV administration, control of anesthetic depth is also quite limited.

Local or regional anesthesia has some application, particularly with larger species or in certain field situations. Care must

be exercised not to exceed the recommended maximum doses for these drugs when they are being infused.

V. PHYSICAL RESTRAINT AND HANDLING

Reptiles should be restrained securely but carefully, to prevent injury to the animal and the handler. Snakes should have the body supported and the head restrained during injection. Cylindrical plexiglass tubes (Fig. 19-3) protect the handler from potential bites, while allowing access to injection sites. The tubes can also be adapted to allow delivery of inhalants for induction. Snakes will typically crawl into a tube without much coaxing, because instinct drives them to escape into a safe retreat when threatened. Restraint of large snakes typically requires more than one handler.

Lizards should be restrained behind the head and supported minimally at the pectoral and pelvic girdles. Most species of lizards can inflict painful bites, and unlike snakes, lizards typically bite and do not release (Fig. 19-4). Many lizards will slap with their tails as a defensive behavior; this can be quite painful, particularly with large animals. Autotomy, or tail amputation in a fracture plane, is an escape mechanism shared by multiple species; therefore, lizards should not be restrained by the tail.

Turtles will, typically, either move their limbs frantically in an attempt to escape or withdraw into their shells. Most turtles can be handled by holding the sides of the shell mid-body. Certain species, however, have very long necks and can easily reach this site; these animals should be restrained by the back of the shell. Turtles also have claws and can scratch while trying to escape.

Crocodylians can be quite large and especially difficult to handle and restrain. Smaller animals, similar to lizards, should be restrained behind the head, with forelimbs and hindlimbs supported. Crocodylians will use their tails to deliver a very strong and painful blow; the tail should always be securely restrained. Large crocodylians require at least two individuals for safe, effective restraint. These animals are best handled with one person situated over the shoulders restraining the head, while the second individual controls the hindlimbs and tail. All crocodylian species will attempt to roll when restrained; handlers should be alert to this behavior and restrain the animals to prevent rolling. Crocodylians have powerful jaws and can inflict serious injury to personnel if not properly controlled. However, if the mouth is closed, the jaws can easily be held shut until bands or tape are placed around the snout. Care should be taken to avoid covering the nares if this type of muzzle is applied.

VI. ANESTHESIA OF VENOMOUS SPECIES

Venomous species pose additional risks when handling and inducing anesthesia. Two species of lizards (Gila monster and

TABLE 19-2
HEMATOLOGIC AND SERUM BIOCHEMICAL VALUES

Measurements	Alligator (<i>Alligator</i> sp.) ^a	Green iguana (<i>Iguana iguana</i>) ^b	Red-eared slider (<i>Trachemys scripta</i>) ^c	Yellow rat snake (<i>Elaphe obsoleta quadrivittata</i>) ^d
Hematology				
PCV (%)	20–30	25–38	25–33	–
RBC ($10^6/\mu\text{l}$)	0.61–1,040	1.0–1.9	0.3–0.8	–
Hgb (g/dl)	509–12.0	6–10	8.0	–
MCV (fl)	327–450	165–305	310–1,000	–
MCH (pg)	–	48–78	95–308	–
MCHC (g/dl)	27–47	20–38	31	–
WBC ($10^3/\mu\text{l}$)	6.4–10.2	3–10	–	–
Heterophils (%)	–	0.35–5.2	–	–
Lymphocytes (%)	–	0.5–5.5	–	–
Monocytes (%)	–	0–0.1	–	–
Eosinophils (%)	–	0–1.7	–	–
Basophils (%)	–	0–0.3	–	–
		0–0.5	–	–
Chemistries				
AP (IU/L)	–	50–290	81–343	55–130
ALT (IU/L)	–	5–68	–	7–29
AST (IU/L)	360	5–52	0–419	15–103
Bilirubin, total (mg/dl)	–	–	–	–
BUN (mg/dl)	–	6.0–15.0	22	–
Calcium (mg/dl)	2.6	8.8–14.0	14–15	3.6
Chloride (mEq/L)	112	117–122	97–107	131
Cholesterol (mg/dl)	0–298	104–333	–	–
Creatine kinase (IU/L)	–	–	1,093–1,483	200–1,231
Creatinine (mg/dl)	–	–	–	–
Glucose (mg/dl)	45–122	169–288	20–113	15–586
LDH (IU/L)	7–120	–	2,389–4,861	86–320
Magnesium (mEq/L)	1.5	–	2.2	2.5
Phosphorus (mg/dl)	–	4–6	3.7–4.3	2.5
Potassium (mEq/L)	3.8–5.9	1.3–3.0	4.3–8.3	4.9
Protein, total (g/dl)	5.1–6.1	5.0–7.8	4.3–6.5	–
Albumin (g/dl)	1.8	2.1–2.8	–	–
Globulin (g/dl)	–	2.5–4.3	–	–
A:G (ratio)	–	–	–	–
Sodium (mEq/L)	145	158–183	133–140	162
Thyroxine ($\mu\text{g/dl}$)	–	–	–	–
Triglycerides (mg/dl)	–	53–691	–	–
Uric acid (mg/dl)	1.0–4.1	1.2–2.4	1	–

^aFrye, 1994; Suedmeyer, 1991.

^bDivers et al., 1996; Frye, 1994.

^cCrawshaw, 1996; Frye, 1994; Jacobson, 1988.

^dRamsey and Dotson, 1995.

beaded lizard) and many snake species have venom glands with varying degrees of toxicity. It is critically important to know the species of snake and its basic behavior before attempting to handle it. A minimum of two people should always be present if venomous reptiles are to be manipulated. Antivenom should be locally available and a clear set of procedures for dealing with envenomations must be developed and implemented to protect personnel. It is essential that all personnel handling venomous reptiles be appropriately trained, and all venomous reptiles should be handled with extreme caution, even when they are anesthetized.

Plexiglass tubes of appropriate size should be used for restraint. The tube diameter should be large enough to allow the snake to crawl inside easily, but small enough to prevent it turning around on itself. Once the front end is safely inside the tube, the handler can securely hold the tube and the snake's body, and the animal will be unable to move either forward or backward (Fig. 19-5a). An injectable anesthetic can then be given, or an inhalant can be administered via the free end of the tube. When the snake is anesthetized, it can be removed from the tube and carefully intubated. Extreme caution is necessary when working around the fangs, to prevent accidental inoculation of

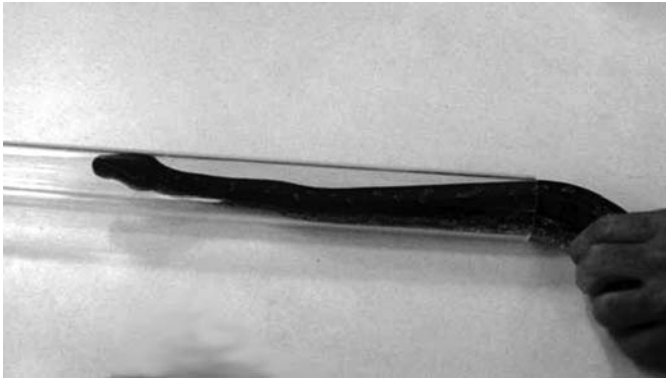

Fig. 19-3 Cylindrical plexiglass tubes facilitate restraint of aggressive or venomous snakes.



Fig. 19-4 In contrast to snakes, lizards typically bite and do not release.

venom. If a tube is not available, a modified squeeze cage can be fashioned and used to restrain the animal for injection. A third option is to introduce the inhalant anesthetic directly into the snake's cage. Depth of anesthesia must be verified before attempting to remove the animal.

VII. ROUTES OF DRUG ADMINISTRATION

Most injectable anesthetics and analgesics are administered via the IM route. Paravertebral muscles are the most common injection site in snakes. Turtles, lizards, and crocodylians may be injected in the forelimbs. IV injections can be given in the ventral coccygeal vein of snakes and most lizards (Schaeffer, 1997; Schumacher and Yelen, 2006). Some turtles have an accessible dorsal venous sinus on the dorsal midline of the tail (Haskell and Pokras, 1994; Lawton, 1992). The turtle's jugular vein can also be used for IV injections or percutaneous catheterization. Snakes require a cutdown procedure to access the right jugular vein. Lizards have a ventral abdominal vein, which is large and can be used for catheterization and delivery of IV drugs and fluids. If a vein is not accessible, intraosseous administration can be used in some reptiles. The distal femur, proximal tibia, and

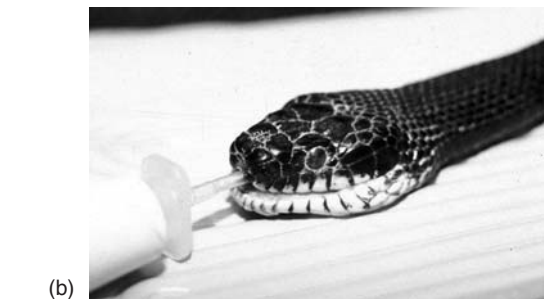

Fig. 19-5 (a) and (b) Endotracheal intubation is easy to perform in most species and helps to ensure adequate anesthesia.

proximal humerus have been cannulated in lizards, and the distal humerus has been used for intraosseous administration in turtles (Heard, 1993). Oral administration of anesthetics and analgesics is unreliable. Likewise, the SC route can result in prolonged and unreliable induction and recovery times (Schumacher and Yelen, 2006).

Endotracheal intubation is a relatively easy process in most reptiles, and is recommended to ensure adequate anesthetic induction and ventilation (Fig. 19-5b). Reptiles are hypoxia tolerant and can convert to anaerobic metabolism. Some species can remain apneic for hours (Bennett, 1991). Animals should be premedicated with an appropriate inhalant or injectable agent. Lidocaine can be applied to the glottis before intubation (Heard, 1993; Nevarez et al., 2002). Once intubated, animals should be ventilated at 4–8 breaths/min (Schumacher and Yelen, 2006).

VIII. INHALANT ANESTHESIA

Isoflurane is the agent of choice. Animals are induced at 4–5% and maintained at 1–3%. Isoflurane should be delivered through a precision vaporizer. A nonbreathing circuit is appropriate for most reptile species; very large animals (<10 kg) may require a standard circle system. Oxygen flow rates vary from 0.2 L/min to 1.0 L/min, depending on size of the reptile (Heard, 1993). Isoflurane provides rapid induction

and recovery, and minimally depresses cardiovascular function (Nevarez et al., 2002; Schumacher and Yelen, 2006). Addition of butorphanol as an analgesic does not appear to significantly impact cardiovascular function (Mosley et al., 2003, 2004).

Sevoflurane has been used in reptiles. Short induction and recovery times and rapid changes in anesthetic depth are characteristic of this inhalant. In desert tortoises, sevoflurane caused a decrease in blood pressure but not in the heart rate (Rooney et al., 1999). Sevoflurane has been used successfully in monitors (Bertelsen et al., 2005) and iguanas (Hernandez-Divers et al., 2005). Recommended concentrations of sevoflurane, if used alone, in reptiles are 7–8% for induction and 3.5–4.5% for maintenance (Schumacher and Yelen, 2006).

Prior to widespread availability of isoflurane and sevoflurane, halothane was used in reptiles. Due to its high vapor pressure, halothane can rapidly reach lethal concentrations and should always be delivered through a precision vaporizer. Animals can be induced with 3–5% and maintained at 1–2%. Although there are some reports of halothane use in an open-drop system, there is a significant risk of mortality with this method (Schaeffer, 1997).

IX. INJECTABLE ANESTHESIA

Ketamine can be administered intramuscularly in combination with other agents for anesthetic induction prior to intubation and for minor procedures. Most commonly, ketamine is combined with medetomidine. A ketamine–medetomidine combination was used to successfully anesthetize both juvenile and adult alligators. Juveniles required higher doses (10 mg/kg IM ketamine; 0.2 mg/kg IM medetomidine) than adults (7.5 mg/kg IM ketamine; 0.13 mg/kg IM medetomidine). Medetomidine was reversed with atipamezole (1.2 mg/kg IM for juveniles; 0.69 mg/kg IM for adults) (Heaton-Jones et al., 2002). Ketamine–medetomidine (10 mg/kg IM ketamine; 0.2 mg/kg IM medetomidine) provided anesthetic depth sufficient for skin incision and suturing in red-eared sliders. Atipamezole (1 mg/kg IM) was used for reversal (Greer et al., 2001). In gopher tortoises, ketamine–medetomidine (5 mg/kg ketamine; 0.1 mg/kg medetomidine) administered intravenously allowed short-term immobilization sufficient for minor diagnostic procedures. Reversal with atipamezole (0.5 mg/kg IV) accelerated recovery but caused severe hypotension; therefore, the authors recommended not using this drug intravenously (Dennis and Heard, 2002).

Tiletamine–zolazepam has been used for minor procedures and as a premedication to facilitate endotracheal intubation. This agent has been effective in lizards (4–6 mg/kg IM), snakes (2–5 mg/kg IM), and crocodylians (5–10 mg/kg IM). Butorphanol can be added at 1–4 mg/kg to provide analgesia. Recovery times can be prolonged with tiletamine–zolazepam anesthesia (Mitchell, 2003; Schumacher and Yelen, 2006).

X. LOCAL/REGIONAL ANESTHESIA

Lidocaine and bupivacaine can be used in reptiles for procedures requiring local anesthesia. Lidocaine provides more rapid analgesia, while bupivacaine has a longer duration of action. Lidocaine can be infiltrated locally at 2–5 mg/kg. Bupivacaine doses range from 1 mg/kg to 2 mg/kg. Because of potential toxic side effects, lidocaine doses should not exceed 10 mg/kg, and bupivacaine doses should not exceed 4 mg/kg (Schumacher and Yelen, 2006).

XI. TOTAL INTRAVENOUS ANESTHESIA

Propofol has been used in reptiles for IV anesthesia induction prior to intubation and maintenance with an inhalant. In lizards and snakes, 3–5 mg/kg is recommended; the range in turtles is 2–5 mg/kg. If venous access is not possible in turtles and lizards, intraosseous administration is an option (Schumacher and Yelen, 2006). Propofol has been used as the sole anesthetic in iguanas. Anesthesia occurred within 3 minutes following delivery of a 5 mg/kg induction dose; maintenance rate was 0.5 mg/kg/min (Bennett et al., 1998). In snakes, an IV injection of 5–10 mg/kg will provide 30–45 minutes of general anesthesia. Propofol can cause respiratory and cardiac depression; therefore, intubation and assisted ventilation are recommended (Mitchell, 2003).

XII. NEUROMUSCULAR BLOCKING AGENTS

Neuromuscular blocking agents have been used in the past to immobilize large crocodylians to facilitate handling. Because these drugs do not provide any analgesia, it is recommended to use more appropriate agents, such as ketamine–medetomidine, for any procedure that has the potential to cause pain or distress.

XIII. PREANESTHESIA

As described earlier in this chapter, various anesthetic combinations such as ketamine–medetomidine are used to anesthetize reptiles prior to intubation and maintenance with inhalants. Opioids such as butorphanol (0.4–2.0 mg/kg SC, IM, IV) and buprenorphine (0.02–0.2 mg/kg IM, IV), if used alone, provide minimal to moderate sedation; however, they may decrease breath holding and struggling (Schumacher and Yelen, 2006). Opioids are more effective when combined with a dissociative such as ketamine or a benzodiazepine such as diazepam. Diazepam [0.2–2 mg/kg IM, IV (0.2–1 mg/kg IM, IV for turtles)] and midazolam (1–2 mg/kg IM, IV) are often used in combination with dissociative anesthetic agents to produce sedation. A combination of ketamine (20–40 mg/kg) and midazolam (2.0 mg/kg IM) produced more effective sedation in turtles than

midazolam alone (Bienzle et al., 1991). Atropine and glycopyrrolate are not typically used in anesthetic regimens for reptiles (Schumacher and Yelen, 2006).

Hypothermia was historically used as a sole anesthetic agent in reptiles. Hypothermia immobilizes animals, but conclusive data documenting its efficacy as an analgesic are lacking. Additionally, hypothermia can cause immune system depression and tissue damage. Therefore, hypothermia is not considered an appropriate sole anesthetic method for reptiles (Heard, 2001; Schaeffer, 1997; Schumacher and Yelen, 2006).

The author recommended that the strategy for premedication is to maintain the reptile at its preferred temperature, and provide warmed balanced electrolyte solution if fluids are indicated. If needed, butorphanol or butorphanol–diazepam can be administered.

XIV. ANESTHETIC INDUCTION

As discussed earlier, reptiles can be induced with an inhalant directly by face mask; however, breath holding may prolong induction times to unacceptable lengths. Most reptiles can be directly intubated while awake, although this method is somewhat challenging (especially in turtles). Therefore,

ketamine–medetomidine, tiletamine–zolezepam–butorphanol, or similar combinations are frequently used for anesthetic induction to facilitate intubation. If venous access is possible, propofol is preferred; it allows rapid induction and, more importantly, rapid recovery when compared to other injectable agents.

The author recommended that the strategy for anesthetic induction is propofol IV followed by intubation and maintenance with an inhalant. If venous or intraosseous access is unsuccessful, ketamine–medetomidine IM should be used. Commonly used anesthetic agents are listed in Table 19-3.

XV. ANESTHETIC MAINTENANCE

Isoflurane and sevoflurane are the preferred inhalant anesthetics for maintenance. Animals should be maintained at their preferred temperature throughout the procedure. Intraoperative fluids should be given if necessary. Balanced electrolyte solutions such as 0.9% NaCl should be used at an infusion rate of 5–10 ml/kg/h (Heard, 2001). Assisted ventilation should be provided throughout the procedure.

The author recommended that the strategy is to use isoflurane for anesthetic maintenance with assisted ventilation throughout the procedure. Maintenance of preferred temperature is essential.

TABLE 19-3
COMMONLY USED ANESTHETICS IN REPTILES

Agent	Lizards	Snakes	Crocodylians	Chelonians
Lidocaine	2–5 mg/kg local	2–5 mg/kg local	2–5 mg/kg local	2–5 mg/kg local
Bupivacaine	1–2 mg/kg local (max dose 4 mg/kg)	1–2 mg/kg local (max dose 4 mg/kg)	2–5 mg/kg local (max dose 4 mg/kg)	1–2 mg/kg local
Diazepam	0.2–2 mg/kg IM, IV	0.2–2 mg/kg IM, IV	0.2–2 mg/kg IM, IV	0.2–1 mg/kg IM, IV
Isoflurane	Induction 4–5% Maintenance 1.5–3%	Induction 5% Maintenance 2–3%	Induction 5% Maintenance 2–3%	Induction 4–5% Maintenance 2–3%
Sevoflurane	Induction 7–8% Maintenance 2.5–4.5%	Induction 7–8% Maintenance 2.5–4.5%	–	Induction 7–8% Maintenance 2.5–4.5%
Ketamine	5–20 mg/kg IM, IV	10–60 mg/kg IM	20–40 mg/kg SC, IM, ICe (sedation to 40–80 mg/kg (anesthesia) ^e)	5–50 mg/kg IM, IV
Ketamine–medetomidine	10 mg/kg (K) + 0.1–0.3 mg/kg (M) IM ^c	–	10 mg/kg (K) + 0.2 mg/kg (M) juvenile 7.5 mg/kg (K) + 0.13 mg/kg (M) IM adult ^a	10 mg/kg (K) + 0.2 mg/kg (M) IM ^b
Ketamine–midazolam	–	–	–	20–40 mg/kg (K) + (M) 2.0 mg/kg IM ^d
Medetomidine	0.05–0.1 mg/kg IM	0.1–0.15 mg/kg IM	–	0.03–0.15 mg/kg IM
Midazolam	1–2 mg/kg IM, IV	1–2 mg/kg IM, IV	–	1–2 mg/kg IM, IV
Tiletamine–zolezepam	2–6 mg/kg IM, IV	2–6 mg/kg IM	5–10 mg/kg SC, IM, ICe (sedation), 10–40 mg/kg (anesthesia) ^f	2–4 mg/kg IM
Propofol	3–5 mg/kg IV, IO	3–5 mg/kg IV	10–15 mg/kg IV ^f	2–5 mg/kg IV, IO

Source: Schumacher and Yelen, 2006.

^aHeaton-Jones et al., 2002.

^bGreer et al., 2001.

^cDivers, 1999.

^dBienzle et al., 1991.

^eSchumacher, 1996.

^fLloyd, 1999.

XVI. MONITORING

During anesthetic induction, reptiles relax anterior to posterior; recovery occurs in the opposite direction (Heard, 2001; Schaeffer, 1997). Reflexes that are commonly used to measure anesthetic depth in reptiles include righting reflex, tail and toe withdrawal, cloacal pinch, and palpebral reflex (turtles and most lizards). In snakes and lizard species with spectacles (scales covering the eye), palpebral and corneal reflexes cannot be evaluated. Lack of corneal reflex and dilated, unresponsive pupils indicate an anesthetic plane that is too deep (Heard, 2001; Schumacher and Yelen, 2006).

Intraoperative monitoring is commonly accomplished with Doppler ultrasonic flow detector, electrocardiography, and/or pulse oximetry. The Doppler probe should be placed over the heart or carotid artery. The coccygeal artery can be used in snakes and lizards. A pencil probe is used in turtles, and is placed at the thoracic inlet.

Electrocardiography is frequently used to monitor reptiles during anesthesia. Leads are placed as in mammalian species. Snakes should have leads placed cranial and caudal to the heart. Reptile electrocardiograms have essentially the same components as mammalian electrocardiograms (Heard, 2001; Nevarez et al., 2002).

The use of pulse oximetry in reptiles has prompted some discussion. Some authors confirm the usefulness of this technology (Nevarez et al., 2002). Others question the accuracy of this method in determining oxygen saturation, due to the presence of normal high methemoglobin levels in reptiles (Heard, 2001). Reflectance anal probes can be placed in the oral cavity of reptiles, and can be used to monitor heart rate and trends in oxygen saturation.

XVII. RECOVERY

Maintenance of the reptile at its preferred temperature is critical during the recovery phase. Circulating water blankets, critical care units, and radiant heat sources are used to maintain appropriate temperature. Caution must be exercised to prevent the reptile from overheating as well as chilling. When recovering from anesthesia, the animal should remain intubated and observed until it is breathing spontaneously. If apnea occurs, the reptile can be ventilated manually with room air using an ambu-bag. Supplemental oxygen is not recommended in normal recoveries, as this will inhibit spontaneous respiration.

XVIII. PAIN MANAGEMENT/ANALGESIA

Manifestation of pain in reptiles can be more challenging to recognize than in mammals. Most reptiles do not vocalize; however, signs such as hunched posture, abnormal movements,

TABLE 19-4

COMMONLY USED ANALGESICS IN REPTILES (ALL SPECIES)

Agent	Dosage/route	Frequency (hours)
Butorphanol	0.4–2.0 mg/kg SC, IM, IV	12–24
Buprenorphine	0.02–0.2 mg/kg SC, IM	12–24
Carprofen	1–4 mg/kg PO, SC, IM, IV	24
Ketoprofen	2 mg/kg SC, IM	24
Meloxicam	0.1–0.2 mg/kg PO	24
Flunixin meglumine	0.5–2 mg/kg IM	12–24

Source: Schumacher and Yelen, 2006.

tremors, increased respiration and heart rate, and increased aggression are classic indicators of pain in these species.

Analgesics should be administered to all reptiles undergoing procedures that may cause pain (Table 19-4). Opioids such as butorphanol (0.4–2.0 mg/kg SC, IM, IV q12 h–24 h) and buprenorphine (0.02–0.2 mg/kg SC, IM q12 h–24 h) are commonly used for postsurgical analgesia. Meloxicam (0.1–0.2 mg/kg PO q24 h), ketoprofen (2 mg/kg SC, IM q24 h), and carprofen (1–4 mg/kg PO, SC, IM, IV q24 h) have also been used, especially for orthopedic pain. Ketoprofen and carprofen can be used for chronic pain, but care should be taken to avoid renal and gastrointestinal complications (Schumacher and Yelen, 2006).

Nonpharmacologic pain management has application to reptiles. Providing appropriate environmental temperatures, returning animals to familiar home cages, and ensuring that animals can retreat to covered areas where they feel secure will decrease stress and increase comfort levels.

XIX. PROLONGED/REPEATED ANESTHESIA

If a reptile is to be anesthetized for a single prolonged procedure, inhalants are preferred over injectable agents. Supplemental anesthesia with injectables other than propofol can result in inability to accurately control anesthetic depth, potential overdosing, and extremely prolonged recovery times. Likewise, because of minimal tissue accumulation, ability to control anesthetic depth, and rapid induction and recovery, inhalants are recommended for repeated anesthesia.

A. Field Anesthesia

Field anesthesia poses unique challenges for individuals working with reptiles. Fortunately, availability of small, portable anesthetic vaporizers has enabled researchers to create field stations equipped with inhalant anesthesia (Fig. 19-6). In some situations requiring brief anesthesia or immobilization, open-drop systems can be used with inhalants such as isoflurane. Use of inhalants permits more rapid release of animals following



Fig. 19-6 Portable isoflurane vaporizer anesthesia units can be used for field anesthesia.

anesthetic recovery and alleviates the need for handling controlled substances in the field. Nonsteroidal anti-inflammatory agents can be used for analgesia. These drugs are not controlled and provide pain relief without sedation. For minor surgical procedures, involving larger reptiles, local infiltration of lidocaine or bupivacaine following sedation can provide appropriate anesthesia and analgesia in the field.

REFERENCES

- Arena, P.C., and Richardson, K.C. (1990). The relief of pain in cold-blooded vertebrates. *ACCART News* 3, 1–4.
- Bennett, R.A. (1991). A review of anesthesia and chemical restraint in reptiles. *J. Zoo Wildl. Med.* 22, 282–303.
- Bennett, R.A., Schumacher, J., Hedjazi-Haring, K., and Newell, S.M. (1998). Cardiopulmonary and anesthetic effects of propofol administered intraosseously to green iguanas. *J. Am. Vet. Med. Assoc.* 212, 93–108.
- Bertelsen, M.F., Mosley, C.A., Crawshaw, G.J., Dyson, D.H., and Smith, D.A. (2005). Anesthetic potency of sevoflurane with and without nitrous oxide in mechanically ventilated Dumeril monitors. *J. Am. Vet. Med. Assoc.* 227, 575–578.
- Bienzle, D., Boyd, C.J., Valverde, A., and Smith, D.A. (1991). Sedative effects of ketamine and midazolam in snapping turtles (*Chelydra serpentina*). *Vet. Surg.* 20, 154 (abstr).
- Carpenter, J.W., Mashima, T.Y., and Rupiper, D.J. (2001). “Exotic Animal Formulary,” 2nd ed., pp 87–89. W.B. Saunders, Philadelphia, PA.
- Crawshaw, G.J. (1996). Comparison of plasma biochemical values in blood and blood-lymph mixtures from red-eared sliders, *Trachemys scripta elegans*. *Bull. Assoc. Rept. Amph. Vet.* 6, 7–9.
- Dennis, P.M., and Heard, D.J. (2002). Cardiopulmonary effects of a medetomidine–ketamine combination administered intravenously in gopher tortoises. *J. Am. Vet. Med. Assoc.* 220, 1516–1519.
- Divers, S.J. (1999). Anesthetics in reptiles. *Exot. DVM* 1(3), 7–8.
- Divers, S.J., Redmayne, G., and Aves, E.K. (1996). Haematological and biochemical values of 10 green iguanas (*Iguana iguana*). *Vet. Rec.* 138, 203–205.
- Frye, F.L. (1994). “Reptile Clinician’s Handbook.” Krieger Publishing Co, Malabar, FL.
- Greer, L.L., Jenne, K.J., and Diggs, H.E. (2001). Medetomidine–ketamine anesthesia in red-eared slider turtles (*Trachemys scripta elegans*). *Contemp. Top. Lab. Anim. Sci.* 40, 9–11.
- Haskell, A., and Pokras, M. (1994). Nonlethal blood and muscle tissue collection from redbelly turtles for genetic studies. *Herpetol. Rev.* 25, 11–12.
- Heard, D.J. (1993). Principles and techniques of anesthesia and analgesia for exotic practice. *Vet. Clin. North Am. Small Anim. Pract.* 23, 1301–1327.
- Heard, D.J. (2001). Reptile anesthesia. *Vet. Clin. North Am. Exot. Anim. Pract.* 4, 83–117.
- Heaton-Jones, T.G., Ko, J.C.H., and Heaton-Jones, D.L. (2002). Evaluation of medetomidine–ketamine anesthesia with atipamezole reversal in American alligators (*Alligator mississippiensis*). *J. Zoo Wildl. Med.* 33, 36–44.
- Hernandez-Divers, S.M., Schumacher, J., Stahl, S., and Hernandez-Divers, S.J. (2005). Comparison of isoflurane and sevoflurane following premedication with butorphanol in the green iguana (*Iguana iguana*). *J. Zoo Wildl. Med.* 36, 169–175.
- Jacobson, E.R. (1988). Use of chemotherapeutics in reptile medicine. In “Exotic Animals.” (E.R. Jacobson and G.V. Kollias, Jr., eds.), pp 35–48. Churchill Livingstone, New York.
- Jacobson, E.R. (1993). Snakes. *Vet. Clin. North Am. Small Anim. Pract.* 23, 1179–1212.
- Lawton, M.P.C. (1992). Anaesthesia. In “British Small Animal Veterinary Association Manual of Reptiles.” (P.H. Beynon, M.P.C. Lawton, and J.E. Cooper, eds.), pp 170–183. British Small Animal Veterinary Association, Gloucestershire.
- Lloyd, M.L. (1999). Crocodylian anesthesia. In “Zoo and Wild Animal Medicine: Current Therapy 4.” (M.E. Fowler and R.E. Miller, eds.), pp 205–216. W.B. Saunders, Philadelphia, PA.
- Millichamp, N.J. (1988). Surgical techniques in reptiles. In “Exotic Animals.” (E.R. Jacobson and G.V. Kollias, eds.), pp 49–73. Churchill-Livingstone, New York.
- Mitchell, M. (2003). Ophidia (Snakes). In “Zoo and Wild Animal Medicine.” (M.E. Fowler and R.E. Miller, eds.), 5th ed., pp 82–91. W.B. Saunders, St. Louis, MO.
- Mosley, C.A., Dyson, D., and Smith, D.A. (2003). The cardiac anesthetic index of isoflurane in green iguanas. *J. Am. Vet. Med. Assoc.* 222, 1565–1568.
- Mosley, C.A., Dyson, D., and Smith, D.A. (2004). The cardiovascular dose-response effects of isoflurane alone and combined with butorphanol in the green iguana (*Iguana iguana*). *Vet. Anaesth. Analg.* 31, 64–72.
- Nevarez, J.G., Pettifer, G.R., and Mitchell, M.A. (2002). Anesthesia case of the month. A suitable choice for anesthetic management of a green iguana for an orchidectomy. *J. Am. Vet. Med. Assoc.* 220, 982–985.
- Page, C.D. (1993). Current reptilian anesthesia procedures. In “Zoo and Wild Animal Medicine.” (M. Fowler, ed.), 3rd ed., pp 140–143. W.B. Saunders, Philadelphia, PA.
- Ramsey, E.C., and Dotson, T.K. (1995). Tissue and serum enzyme activities in the yellow rat snake (*Elaphe obsoleta quadrivittata*). *Am. J. Vet. Res.* 56, 423–428.
- Rooney, M.B., Levine, G., Gaynor, J., Macdonald, E., and Wimsatt, J. (1999). Sevoflurane anesthesia in desert tortoises (*Gopherus agassizii*). *J. Zoo Wildl. Med.* 30, 64–69.
- Schaeffer, D.O. (1994). Miscellaneous species: Anesthesia and analgesia. In “Research Animal Anesthesia, Analgesia and Surgery.” (A.C. Smith and M.M. Swindle, eds.), pp 129–136. Scientists Center for Animal Welfare, Greenbelt, MD.
- Schaeffer, D.O. (1997). Anesthesia and analgesia in nontraditional laboratory animal species. In “Anesthesia and Analgesia in Laboratory Animals.” (D.F. Kohn, S.K. Wixson, W.J. White, and G.J. Benson, eds.), pp 337–378. Academic Press, New York.

- Schumacher, J. (1996). Reptiles and amphibians. In "Lumb and Jones' Veterinary Anesthesia." (J.C. Thurman, W.J. Tranquilli, and G.J. Benson, eds.), 3rd ed., pp 670–685. Williams & Wilkins, Baltimore.
- Schumacher, J. (2000). Fluid therapy in reptiles. In "Kirk's Current Veterinary Therapy 13 Small Animal Practice." (J.D. Bonagura, ed.). W.B. Saunders, St. Louis, MO.
- Schumacher, J., and Yelen, T. (2006). Anesthesia and analgesia. In "Reptile Medicine and Surgery." (D.R. Mader, ed.), pp 442–452. W.B. Saunders, St. Louis, MO.
- Suedmeyer, W.K. (1991). Iron deficiency in a group of American alligators: Diagnosis and treatment. *J. Small Exot. Anim. Med.* **1**, 69–72.
- Wang, T., Smits, A.W., and Burggren, W.W. (1998). Pulmonary function in reptiles. In "Biology of the Reptilia". Vol. 19, Morphology G: Visceral Organs. (C. Gans, and A.S. Gaunt, eds.). Society for the Study of Amphibians and Reptiles, St. Louis, MO.

Anesthesia and Analgesia in Amphibians

Dorcas P. O'Rourke and Audrey L. Jenkins

I. Introduction	511
II. General Considerations	511
III. Preanesthetic Evaluation and Preparation	513
IV. Anesthetic Techniques	513
V. Physical Restraint and Handling	514
VI. Routes of Drug Administration	514
VII. Immersion Anesthesia	514
VIII. Volatile Anesthesia	515
IX. Injectable Anesthesia	516
X. Topical/Regional Anesthesia	516
XI. Preanesthesia/Anesthesia Induction	516
XII. Anesthetic Maintenance and Monitoring	516
XIII. Recovery	516
XIV. Pain Management/Analgesia	517
XV. Field Anesthesia	517
XVI. Larval Anesthesia	517
References	518

I. INTRODUCTION

Two orders of Class Amphibia are commonly used in research. Anurans (frogs and toads) are found in virtually all animal facilities, and caudates (salamanders) are frequently subjects of developmental and ecological research.

II. GENERAL CONSIDERATIONS

Amphibians are poikilothermic and therefore rely on external heat sources to generate adequate body temperatures for

metabolic processes. Like reptiles, each amphibian species has a preferred temperature range. There is, however, considerable variation among species, and amphibians can be found in a wide variety of temperate and tropical habitats (Table 20-1). Preferred temperature ranges for a given species should be obtained if at all possible. If this data is unavailable, temperate frogs can be kept at approximately 20–25°C and tropical frogs at 25–30°C (Raphael, 1993). Many salamander species live under leaf litter in cool environments, or in cool water streams in mountainous regions. These temperate species prefer ranges of 10–16°C (Jaeger, 1992). Tropical salamanders may be kept at 15–20°C (Raphael, 1993).

TABLE 20-1
GENERAL TEMPERATURE RANGES

	Temperate	Tropical
Frog/toad ^a	20–25°C (68–77°F)	25–30°C (77–86°F)
Salamander ^{a,b}	10–16°C (50–60.8°F)	15–20°C (59–68°F)

^aRaphael, B.L. (1993). Amphibians. *Vet. Clin. North Am. Small Anim. Pract.* 23, 1271–1286.

^bJaeger, R.G. (1992). Housing, handling and nutrition of salamanders. In "The Care and Use of Amphibians, Reptiles and Fish in Research." (D.O. Schaeffer, K.M. Kleinow, and L. Krulisch, eds.), pp 25–29. S.C.A.W.

Amphibian respiratory anatomy is as variable as temperature preference. Most amphibians begin life as aquatic larvae, with gills as the primary organ for oxygen exchange. Some larvae (for instance, *Xenopus* tadpoles and *Ambystoma tigrinum* larvae) have lungs as well as gills, and swim to the water's surface to gulp air (Fig. 20-1). Many salamander larvae also utilize cutaneous respiration for a significant portion of oxygen exchange. Adult frogs have paired lungs; in some species, cartilage reinforces the lungs. Adult salamanders may have lungs, gills, both lungs and gills, or neither (Fig. 20-2). One group of salamanders, the plethodontid salamanders, lack lungs and breathe solely through cutaneous respiration. The buccopharyngeal cavity is highly vascular and is also used for respiration. In species that breathe through lungs, inspiration begins by contraction of throat muscles, which depress the floor of the buccal cavity. This has the effect of pulling air through the nostrils and filling buccal cavity with air. Consequently, closure of the nostrils, opening of the glottis, and elevation of the buccal cavity floor then force air into the lungs. To remove air from the lungs, the buccal floor is depressed while the nares are closed and the glottis is open. Then the nares are opened, the glottis is closed, and the buccal floor is elevated to force air out of the mouth (Duellman and Trueb, 1986). The trachea of most amphibians is extremely short, and caution must be taken if intubation is attempted (Wright, 2001). Both low oxygen and elevated carbon dioxide levels stimulate respiration in most amphibians (Van Vliet and West, 1992). High oxygen levels inhibit respiratory movements in amphibians.

Amphibian skin is highly glandular. There are two basic types of skin glands: mucous and granular. Mucous glands are numerous and found over the entire body surface. They secrete a slimy mucus, which serves to keep skin moist and facilitate cutaneous respiration (Fig. 20-3). Mucus also protects the skin from abrasive trauma and inhibits pathogen entry. Granular glands are less abundant than mucous glands, and may be scattered over the body or clustered. The parotoid glands of toads, which appear as raised areas behind the eyes, are examples of clustered granular glands. Parotoid glands secrete cardiotoxins designed to deter

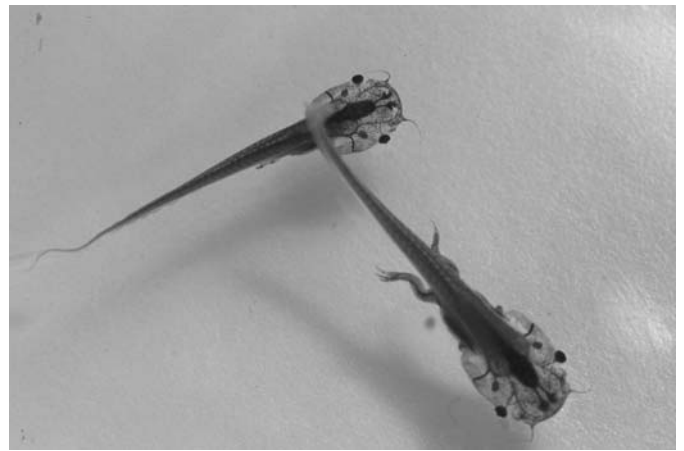

Fig. 20-1 In addition to breathing through gills, *Xenopus* tadpoles will gulp air at the water's surface.



Fig. 20-2 The axolotl is a salamander that breathes through feathery external gills.



Fig. 20-3 Mucous glands cover the entire body of the amphibian.

predators. Other toxins secreted by granular glands include hallucinogens and neurotoxins. Different types of granular glands can secrete a variety of substances, including pheromones and antimicrobial compounds (Clarke, 1997).

TABLE 20-2
HEMATOLOGIC AND SERUM BIOCHEMICAL VALUES

Measurements	African clawed frog (<i>Xenopus laevis</i>) ^a	Bullfrog (<i>Rana catesbeiana</i>) ^b	Leopard Frog (<i>Rana pipiens</i>) ^c	Japanese Newt (<i>Cynops pyrrhogaster</i>) ^d	Axolotl (<i>Ambystoma mexicanum</i>) ^e
Hematology					
PCV (%)	–	30.1 (25–39)	24.6 (31–39.9)	40.0 (38.1–41.9)	–
Hgb (g/dl)	14.86	6.8 (5.12–11.06)	26.75 (2.4–9.6)	–	–
WBC (10 ³ /μl)	8.2	20.5 (11.6–32.7)	–	–	–
Neutro/heter (%)	8.0 (6.9–9.1)	60.9 (40.0–86.1)	26.5 (11–48)	28.0 (26.4–30.6)	60.9 (57.3–64.5)
Lymphocytes (%)	65.3 (62.6–68.0)	26.8 (16.3–39.8)	53.4 (29–75)	3.0 (2.6–3.4)	26.4 (24.6–28.2)
Monocytes (%)	0.5	2.9 (1.0–5.0)	11.0 (5–24)	6.0 (5.0–7.0)	–
Eosinophils (%)	–	5.8 (2.0–11.9)	7.3 (4–11)	4.0 (3.3–4.7)	6.1 (4.2–8.0)
Basophils (%)	8.5 (7.1–9.9)	3.5 (0.6.0)	4.4 (0.9)	57.0 (3.8–60.2)	0.1 (0.0–0.2)
Chemistries					
Sodium (mEq/L)	–	118.6 (99–144)	–	–	–
Potassium (mEq/L)	–	3.62 (1.92–5.84)	–	–	–
Chloride (mEq/L)	–	108.6 (1.0–116)	–	–	–
Albumin (g/dl)	–	1.58 (1.02–2.67)	–	–	–
Calcium (mg/dl)	–	8.31 (6.0–11.2)	–	–	–
Creatinine (mg/dl)	–	4.83 (1.07–12.3)	–	–	–
AST (IU/L)	–	48.1 (23–80)	–	–	–
ALT (IU/L)	–	12.4 (7–20)	–	–	–
LDH (IU/L)	–	117 (50–260)	–	–	–
Phosphorus (mg/dl)	–	8.83 (4.1–13.7)	–	–	–
Magnesium (mEq/L)	–	2.41 (1.33–4.09)	–	–	–
Uric acid (mg/dl)	–	13.4 (1.3–30.2)	–	–	–
Urea (mg/dl)	–	84.2 (30.1–180)	–	–	–
Glucose (g/L)	–	0.5 (0.1–0.98)	–	–	–

^aCarpenter, J.W. (2005). Exotic animal formulary, ed 3, WB Saunders, St Louis.

^bCoppo, J.A., Mussart, N.B., and Fioranelli, A. (2005). Blood and urine physiological values in farm-cultured *Rana catesbeiana* (Anura: Ranidae) In Argentina. *Rev. Biol. Trop. (Int. J. Trop. Biol)* **53**(3–4), 545.

^cRouf, M. A. Hematology of the leopard frog, *Rana pipiens*. *Copeia*, Vol. **1969**, No. 4. (Dec. 5, 1969), pp. 682–687.

^dPfeiffer, C.J. Pyle, H. and Asashima, M. (1990). Blood cell morphology and counts in the Japanese newt (*Cynops pyrrhogaster*). *J Zoo Wildlife Med.* **21**(1), 56–64.

^eUssing, A.P. and Rosenkilde, P. (1995). Effect of Induced Metamorphosis on the Immune System of the Axolotl, *Ambystoma mexicanum* *General and Comparative Endocrinology* **97**(3), 308–319.

While hematologic and serum biochemical data are limited, Table 20-2 provides values for a few of the more common species used in research.

Dechlorinated water should be kept on hand to ensure hydration of the animal and to prepare anesthetic solutions for immersion anesthesia.

III. PREANESTHETIC EVALUATION AND PREPARATION

Although aspiration of stomach contents is rare in amphibians, they should be fasted, if possible, prior to anesthesia. Recommended fasting time for small frogs (less than 20 g body weight) is 4 hours. Medium-sized frogs and insectivorous salamanders should be fasted for 48 hours, while larger amphibians that eat vertebrates require at least 7 days (Wright, 2001). The small body size of most amphibians may preclude collection of extensive laboratory data; however, a physical evaluation should be performed to ensure the animal is healthy and well hydrated.

IV. ANESTHETIC TECHNIQUES

Immersion anesthesia is the preferred method for most amphibian species. Advantages include ease of administration and maintenance and applicability to both aquatic and terrestrial animals. Inhalants can be used, but care must be taken to avoid desiccating animals from high oxygen flow rates delivered through a face mask. Injectable drugs can be used for anesthesia, but these agents have much narrower margins of safety and prolonged recovery times.

Hypothermia was once widely thought to be appropriate for anesthesia of amphibians, but several recent reviews of

hypothermia have refuted this premise (Green, 2003; Machin, 2001; Martin, 1995; Schaeffer, 1997), and concluded that hypothermia should not be used to immobilize amphibians for any potentially painful procedure.

V. PHYSICAL RESTRAINT AND HANDLING

Amphibians must be restrained firmly but gently, and care must be taken to preserve the integrity of the protective mucous layer. Nonpowdered latex or nitrile gloves should be used when handling amphibians, to protect the animals' delicate skin as well as to prevent toxic skin secretions from getting on the handler. When dealing with large species that may possess the ability to eject toxins from the parotoid glands, such as the marine toad, eye protection is also advisable. Small amphibians can be manually restrained in one hand. The tails of many salamanders will break off if grabbed (autotomy—a predator avoidance mechanism); therefore, cautious restraint of these species is warranted. Larger species should be grasped around the pectoral and pelvic girdles, with the body supported as much as possible (Fig. 20-4). Many large frogs and salamanders can inflict painful bites, so caution must be exercised when handling these animals. It is always advisable to have drugs and supplies prepared and arranged beforehand to minimize the time amphibians must be manually restrained.

VI. ROUTES OF DRUG ADMINISTRATION

The most common method of anesthetizing amphibians is immersion anesthesia. Animals should be placed in a clean container in a solution of anesthetic dissolved in dechlorinated water (Fig. 20-5). Additional containers of dechlorinated water should be kept on hand for moistening the amphibian if needed during the procedure, and as a recovery tank for aquatic species. Inhalant agents can be administered to amphibians, through mask induction or in a chamber. If the animal is intubated, the endotracheal tube should be inserted only a short distance because the trachea of most species is very short (Wright, 2001). Injectable anesthetics can be administered intracoelomically, intramuscularly, or intravenously (Table 20-3). Some frog species have paired lymphatic structures, called dorsal lymph sacs, located subcutaneously under the skin of the back. These structures communicate with the venous circulation and offer an excellent site for injection.

VII. IMMERSION ANESTHESIA

Tricaine methanesulfonate (MS-222) is the preferred agent for amphibian immersion anesthesia. It is available as a white



Fig. 20-4 Larger amphibians should be supported around the pectoral and pelvic girdles when restrained. Moistened, nonpowdered gloves should be worn to protect the animal's delicate skin.



Fig. 20-5 Tricaine methanesulfonate (MS-222) is the preferred anesthetic agent for amphibians. Due to its acidity, it should be buffered.

powder, which is easily dissolved in dechlorinated water. When dissolved, formation of methanesulfonic acid creates an acidic solution. In this environment, the MS-222 is ionized and less bioavailable, resulting in longer induction times and shorter periods of effective anesthesia. The acidic solution is also irritating to amphibian skin (Cakir and Strauch, 2005; Downes, 1995). Therefore, all solutions of MS-222 should be buffered.

TABLE 20-3
COMMONLY USED ANESTHESIA IN AMPHIBIANS

Agent	Salamanders/frog	Larval/aquatic	Toads
Tricaine methane sulfonate (MS-222) buffered ^a	500 mg/L–2 g/L immersion	200–500 mg/L immersion	1–3 g/L immersion
Propofol ^b	9.5 mg/kg i.c. (sedation) 30 mg/kg i.c. (anesthesia)		
Ketamine ^c	50–150 mg/kg SC, IM, IV		50–150 mg/kg SC, IM, IV, dorsal lymph sacs
Isoflurane ^d	0.03–0.06 ml/g dermal		

^aArena, P.C., and Richardson, K.C. (1990). The relief of pain in cold-blooded vertebrates. *ACCART News* 3, 1–4. Cooper, J.E. (1987). Veterinary work with non-domesticated pets IV. Lower vertebrates. *Br. Vet. J.* 143, 193–202. Crawshaw G.J. (1993). Amphibian medicine. In “Zoo and Wild Animal Medicine.” (M.E. Fowler, ed.): 3rd ed., pp 131–139. Saunders, Philadelphia. Stetter M.D. (2001). Fish and amphibian anesthesia. *Vet. Clin. North Am. Exot. Anim. Pract.* 4(1), 69–82.

^bVon Esse, F.V. and Wright, K.M. (1999). Effect of intracoelomic propofol in white’s tree frogs, *pelodyras caerulea*. *Assoc Reptilian Amphibian Vet.* 9(3).

^cCrawshaw G.J. (1993). Amphibian medicine. In “Zoo and Wild Animal Medicine.” (M.E. Fowler, ed.), 3rd ed., pp 131–139. Saunders, Philadelphia. Wright, K.M. (2006). Overview of amphibian medicine. In “Reptile Medicine and Surgery.” (D.R. Mader, ed.), pp 941–971. WB Saunders, St. Louis.

^dSmith J.M. and Stump, K.C. (2000). Isoflurane Anesthesia in the African Clawed Frog (*Xenopus laevis*). *Comp. Top.* 39, 39–42.

Several methods for buffering MS-222 have been described. The pH of a 1 g/L MS-222 solution can be raised from 3.0 to 7.0 by addition of 34 mL of 0.5 M Na₂HPO₄ to 2 L of the 1 g/L MS-222 solution (Downes, 1995; Schaeffer, 1997). Sodium bicarbonate can also be used as a buffer, at 420–1,050 mg/L (10–25 mEq/L) (Crawshaw, 1992; Schaeffer, 1997). If MS-222 is used frequently, it can be prepared as a stock solution at 10 g/L, then diluted and buffered as necessary for individual procedures. The stock solution should be stored in a dark container away from light to avoid anesthetic breakdown (Stetter, 2001). Stoskopf (1995) recommends that stock solutions be changed monthly; however, the shelf life can be extended if refrigerated or frozen.

Dosage recommendations for MS-222 vary according to species and developmental stages. Larval amphibians and totally aquatic, gilled species tend to be more sensitive and can be anesthetized with 200–500 mg/L MS-222. Salamanders and frogs typically require 500 mg/L to 2 g/L, and toads are reported to need 1–3 g/L MS-222 for anesthesia (Arena and Richardson, 1990; Cooper, 1987; Crawshaw, 1993; Stetter, 2001). A recent study demonstrated that 200 mg/L MS-222 abolished righting reflex and nociceptive reflex in leopard frogs (*Rana pipiens*), and decreased recovery times (Cakir and Strauch, 2005); however, induction times were longer with the lower concentration.

Benzocaine, an immersion anesthetic related to MS-222, has been used in amphibians. Benzocaine is more potent than MS-222 and causes rapid induction, but has a much narrower margin of safety. In one study, all leopard frogs anesthetized with 200 mg/L benzocaine for a prolonged period became hypoxic and required resuscitation (Cakir and Strauch, 2005). Benzocaine is less soluble in water than MS-222; consequently, it must first be dissolved in ethanol to increase water solubility (Crawshaw, 1993).

MS-222 appears to be the safest anesthetic agent for prolonged procedures. Dripping maintenance concentrations onto the animal or periodic re-immersion into a maintenance concentration anesthetic bath will generally suffice when prolonged

anesthesia is required. MS-222 is commonly used for repeat anesthesia in *Xenopus* oocyte harvest. In this authors’ experience, no adverse effects or anesthetic tolerance developed with repeated use of MS-222.

Clove oil, with eugenol as its principal chemical constituent, has been used for years in dentistry procedures. This agent has also been used to chemically restrain fish, and has been investigated in amphibians. One study found that immersion in a 310–318 mg/L clove oil solution induced anesthesia in leopard frogs within 15 minutes. Anesthetic duration was widely variable, and gastric prolapse was common with the use of this agent (Lafortune et al., 2001). A second study in fish concluded that clove oil was effective for immobilization, but had more prolonged recovery times and a narrower margin of safety than MS-222. This study also stated that fish anesthetized with clove oil were more reactive to needle stick than fish anesthetized with MS-222, and that the analgesic properties of clove oil are unknown (Sladky et al., 2001).

Chlorbutanol (chlorotone), an alcohol, has historically been used at 0.2% to anesthetize amphibians. Although once used for survival procedures in a variety of species, newer and more effective anesthetics are available; and chlorbutanol is now largely used at much higher doses to euthanize field-collected amphibians.

VIII. VOLATILE ANESTHESIA

Isoflurane is the volatile anesthetic most commonly used for amphibians. Animals can be induced with 3–5% in a chamber. Induction time can exceed 20 minutes. Care should be taken to ensure the chamber interior is moistened to prevent the amphibian from drying out during induction. Larger amphibian species with lungs can be intubated (using an uncuffed, short endotracheal tube) and maintained with assisted ventilation on lower concentrations (Crawshaw, 1993).

IX. INJECTABLE ANESTHESIA

Propofol has been evaluated as an anesthetic agent in two species of frogs. Three doses of propofol were delivered intracoelomically in three White's tree frogs. Low dose (9.5 mg/kg) produced sedation, 30 mg/kg resulted in a deeper anesthetic plane, and 53 mg/kg caused death of the animal. Complete recovery took 16 hours (Von Esse and Wright, 1999). A second study injected 10 mg/kg propofol perivascularly into the sublingual plexus of 12 leopard frogs. Although sedation or light anesthesia was observed in all frogs, no animals reached a plane of surgical anesthesia (Lafortune et al., 2001).

Ketamine has been used for restraint and minor procedures. Dose ranges of 50–150 mg/kg have been administered SC, IM, IV, or into the dorsal lymph sacs. Induction times, level of anesthetic depth, and recovery times vary greatly with species (Crawshaw, 1993; Wright, 2006). Tiletamine–zolazepam was found to be extremely species variable, and unreliable as an anesthetic agent in frogs (Letcher and Durante, 1995).

Barbiturates have long been used as anesthetic agents in mammals, with doses needed to abolish both the righting reflex and nociceptor response well below a lethal range. Recent studies, however, demonstrate that these agents are ineffective in providing the same level of analgesia in both larval and adult bullfrogs. Levels of barbiturates such as thiopental needed to suppress the nociceptor response in amphibians overlapped with lethal levels (Downes and Courogen, 1996; Downes et al., 1999).

X. TOPICAL/REGIONAL ANESTHESIA

Isoflurane has been used topically to anesthetize amphibians. Stetter (2001) described combining 3 mL isoflurane, 1.5 mL water, and 3.5 mL KY jelly into a closed container and agitating the mixture until uniform viscosity was achieved. The solution can be applied directly to the dorsal surface of the amphibian at 0.025–0.035 mL/g (Stetter et al., 1996). Lower doses are adequate for salamanders, frogs, and newts; while toads require higher doses. After application of the solution, the amphibian is placed in a closed container until anesthetized, typically for 5–15 minutes. Any residual anesthetic solution is then wiped from the dorsum with a saline-soaked gauze. The duration of anesthesia is 45–80 minutes (Stetter, 2001).

Another dermal application study used a 2×2 cm² or 3×3 cm² absorbent pad with moisture-proof backing saturated with 0.03–0.06 mL/g isoflurane to induce anesthesia in *Xenopus laevis*. Anesthesia was reached in 3–12 minutes, and animals remained anesthetized for 4–57 minutes (Smith and Stump, 2000).

Lidocaine and bupivacaine both inhibit nerve fiber conduction in amphibians (Bainton and Strichartz, 1994; Dalkilic et al., 2004), and use of lidocaine alone and in combination with other anesthetic agents has been reported (Brown, 1995; Narins and

Wagner, 1989). Due to the permeability of amphibian skin, all local anesthetics should be used with caution.

XI. PREANESTHESIA/ANESTHETIC INDUCTION

The anesthetic agent most commonly used in amphibians is MS-222. The animal is placed directly into the buffered solution of appropriate concentration. During induction, the righting reflex is lost. Light anesthesia is characterized by loss of righting reflex, corneal reflex, and lack of abdominal respiration (Stetter, 2001; Wright, 2006). Deep (surgical) anesthesia is indicated by loss of withdrawal reflex and gular (throat) respiratory movements (Crawshaw, 1993; Stetter, 2001; Wright, 2006). Once this level is achieved, the amphibian can be removed from the anesthetic solution and prepared for the procedure. Preemptive analgesics can be given at this time. Induction times will vary with species and concentration, but should take about 15–20 minutes. The authors' preferred strategy is direct induction using the appropriate concentration of MS-222, followed by preemptive administration of an alpha-adrenergic analgesic such as xylazine.

XII. ANESTHETIC MAINTENANCE AND MONITORING

Once the amphibian has been induced with MS-222, it can be removed from the anesthetic solution. In the authors' experience, at least 30 minutes of surgical anesthesia can be achieved for *X. laevis* oocyte harvest using a buffered 1 g/L MS-222 solution, ample time for completion of the surgical procedure. If supplemental anesthesia is required for more prolonged procedures, dilute anesthetic solution can be dripped on the amphibian's skin (Fig. 20-6). If inhalant isoflurane is used for larger terrestrial species, the amphibian can be intubated and ventilation assisted to maintain anesthesia. Topical isoflurane will provide 45–80 minutes of anesthesia (Stetter, 2001). At surgical levels of anesthesia, pulmonary and gular respiration will cease and the amphibian will breathe entirely transdermally (Crawshaw, 2003). Therefore, it is critical to keep the skin moist throughout the anesthetic period. The heart rate can be monitored visually, or with a Doppler flow detector, ECG, or ultrasound (Crawshaw, 2003; Stetter, 2001). The authors' preferred strategy is to maintain animals on MS-222, supplementing if necessary, keeping animals moist with dechlorinated water, and using visual observation of heart rate for monitoring.

XIII. RECOVERY

Once the procedure is complete, the amphibian can be rinsed in clean, dechlorinated water to remove any residual anesthetic.



Fig. 20-6 Supplemental anesthesia can be delivered by dripping a dilute solution onto the amphibian's skin.

Recovery from immersion anesthesia can take over 30 minutes; recovery from inhalants is usually more rapid. Withdrawal reflexes return first, followed by regular respiration and righting reflex. Caution should be taken to avoid unnecessary warming because cutaneous respiration cannot meet the metabolic demands of increased body temperature. Ambient recovery temperatures of 60–70°F are appropriate for most species (Stetter, 2001).

XIV. PAIN MANAGEMENT/ANALGESIA

Amphibians and other nonmammalian vertebrates can demonstrate four basic behaviors to painful stimuli. These are startle responses; vigorous nonspecific escape responses; vocalization; and rubbing, wiping, or biting at the source of the pain (Green, 2003; Machin, 1999). There are a number of drugs that can be utilized for the relief of pain. Opioids are analgesics that work by binding to receptors found principally in the central nervous system and the gastrointestinal tract. While a number of various receptor sites exist, the four most prevalent are mu (μ), kappa (κ), delta (δ), and sigma (σ). Morphine is considered a true opioid agonist, exerting its effects at the mu receptor site. Buprenorphine is a partial mu agonist, meaning that only a partial activation occurs subsequent to its binding. Lastly, butorphanol is a partial opiate agonist/antagonist. Its agonist activity occurs at the kappa and sigma receptors, while its antagonist properties occur at the mu site. It is for this reason that care must be taken when using butorphanol with a true agonist such as morphine, because butorphanol will compete with morphine for the same site (Heavner, 1997; Machin, 1999;

Stevens, 2004). When choosing a drug for pain relief, consideration for the species is paramount because the effect can vary greatly between species. Machin (1999, 2001) provides an excellent summary of research describing amphibian pain fibers, pathways, and receptor systems. Stevens (2004) summarizes his laboratory's significant contributions to understanding opioid receptor function in amphibians, using the acetic acid wiping response in the leopard frog, *R. pipiens*, first described by Pezalla (1983). Subsequently, this model has been widely used to evaluate other analgesic compounds as well. Although this test specifically addresses cutaneous and not visceral pain, it provides a sound scientific basis for determining appropriate analgesic use in amphibians.

Morphine (114 mg/kg in the dorsal lymph sac) provided maximum analgesia for at least 5 hours in leopard frogs (Stevens et al., 2001). This study also documented significant analgesia for the same period with the following agents delivered by the same route: chlorpromazine (32 mg/kg), chlor-diazepoxide (90 mg/kg), and buprenorphine (14 mg/kg); and less effective analgesia with ketorolac (26 mg/kg) and butorphanol (33 mg/kg). Brenner et al. (1994) documented greater than 8 hours of analgesic efficacy with dexmedetomidine, an alpha-2 adrenergic, at 120 mg/kg injected into the dorsal lymph sac. Terril-Robb et al. (1996) demonstrated 12–24 hours of analgesia with xylazine (10 mg/kg intracoelomic), another alpha-2 adrenergic. They also documented 12 hours of analgesia with butorphanol (25 mg/kg intracoelomic). Sedation and depression of motor reflexes associated with administration of opioids and alpha-2 adrenergics in mammals have not been observed in amphibians (Machin, 2001).

XV. FIELD ANESTHESIA

Ease of transportation and administration makes MS-222 the agent of choice for many field studies. Lower concentrations can be used for immobilization and brief procedures. Higher concentrations can be used for surgical or other painful procedures. If euthanasia is required, lethal concentrations of MS-222 can be used. Alternatively, surgical concentrations followed by physical methods are appropriate.

XVI. LARVAL ANESTHESIA

Many amphibian larvae are aquatic and breathe through gills. They are also more sensitive to the effects of anesthetics. Therefore, concentrations of immersion anesthetics should be lower than for adult or terrestrial species. When anesthetizing larvae, fresh dechlorinated water from the animals' home tank should be on hand and used as a recovery solution.

REFERENCES

- Arena, P.C., and Richardson, K.C. (1990). The relief of pain in cold-blooded vertebrates. *ACCART News* **3**, 1–4.
- Bainton, C.R., and Strichartz, G.R. (1994). Concentration dependence of lidocaine-induced irreversible conduction loss in frog nerve. *Anesthesiology* **81**, 657–667.
- Brenner, G.M., Klopp, A.J., Keason, L.L., and Stevens, C.W. (1994). Analgesic potency of alpha adrenergic agents after systemic administration in amphibians. *J. Pharmacol. Exp. Ther.* **270**, 540–545.
- Brown, C.S. (1995). Rear leg amputation and subsequent adaptive behavior during reintroduction of a green tree frog, *Hyla cinerea*. *Bull. Assoc. Reptile Amphib. Vet.* **5**, 516–517.
- Cakir, Y., and Strauch, S.M. (2005). Tricaine (MS-222) is a safe anesthetic compound compared to benzocaine and pentobarbital to induce anesthesia in leopard frogs (*Rana pipiens*). *Pharmacol. Rep.* **57**, 467–474.
- Clarke, B.T. (1997). The natural history of amphibian skin secretions, their normal functioning, and potential medical applications. *Biol. Rev. Camb. Philos. Soc.* **72**, 365–379.
- Cooper, J.E. (1987). Veterinary work with non-domesticated pets IV. Lower vertebrates. *Br. Vet. J.* **143**, 193–202.
- Crawshaw, G.J. (1992). Medicine and disease of amphibians. In “The Care and Use of Amphibians, Reptiles and Fish in Research.” (D.O. Schaeffer et al., eds.), pp 41–48. Scientist Center for Animal Welfare, Bethesda.
- Crawshaw, G.J. (1993). Amphibian medicine. In “Zoo and Wild Animal Medicine, Current Therapy.” (M.E. Fowler, ed.), 3rd ed., pp 131–139. Saunders, Philadelphia.
- Crawshaw, G.J. (2003). Anurans (Anura, Salienta): Frogs, Toads. In “Zoo and Wild Animal Medicine.” (M.E. Fowler, and R.E. Miller, eds.) 5th ed. pp 22–33. Saunders, St. Louis.
- Dalkilic, N., Bariskaner, H., Dogan, N., Demirel, I., and Ilhan, B. (2004). The effect of bupivacaine on compound action potential parameters of sciatic nerve fibers. *Int. J. Neurosci.* **114**, 1–16.
- Downes, H. (1995). Tricaine anesthesia in amphibia: A review. *Bull. Assoc. Reptil. Amphib. Vet.* **5**, 11–16.
- Downes, H., and Courogen, P.M. (1996). Contrasting effects of anesthetics in tadpole bioassays. *J. Pharm. Exp. Ther.* **278**, 284–296.
- Downes, H., Koop, D.R., Klopfenstein, B., and Lessov, N. (1999). Retention of nociceptor responses during deep barbiturate anesthesia in frogs. *Comp. Biochem. Physiol. C Pharmacol. Toxicol. Endocrinol.* **124**, 203–210.
- Duellman, W.E., and Trueb, L. (1986). “Biology of Amphibians.” McGraw-Hill, New York.
- Green, S.L. (2003). Postoperative analgesics in South African clawed frogs (*Xenopus laevis*) after surgical harvest of oocytes. *Comp. Med.* **53**, 244–247.
- Heavner, J.E. (1997). Pharmacology of analgesics. In “Anesthesia and Analgesia in Laboratory Animals.” (D.F. Kohn, S.K. Wixson, W.J. White, and G.J. Benson, eds.), pp 43–56. Academic Press, San Diego.
- Jaeger, R.G. (1992). Housing, handling and nutrition of salamanders. In “The Care and Use of Amphibians, Reptiles and Fish in Research.” (D.O. Schaeffer, K.M. Kleinow, and L. Krulisch, eds.), pp 25–29. Scientists Center for Animal Welfare, Bethesda.
- Lafortune, M., Mitchel, M.A., and Smith, J.A. (2001). Evaluation of medetomidine, clove oil and propofol for anesthesia of leopard frogs, (*Rana pipiens*). *J. Herpe. Med. Surg.* **11**, 13–18.
- Letcher, J. and Durante, R. (1995). Evaluation of use of tiletamine/zolazepam for anesthesia of bullfrogs and leopard frogs. *JAVMA* **207**, 80–82.
- Machin, K.L. (1999). Amphibian pain and analgesia (review). *J. Zoo Wildl. Med.* **30**, 2–10.
- Machin, K.L. (2001). Fish, amphibian, and reptile analgesia. In “Analgesia and Anesthesia.” *Vet. Clin. North Am. Exot. Anim. Pract.* **4**, P19–P33.
- Martin, B.J. (1995). Evaluation of hypothermia for anesthesia in reptiles and amphibians. *ILAR J.* **37**, 186–190.
- Narins, P.M., and Wagner, I. (1989). Noise susceptibility and immunity of phase locking in amphibian auditory-nerve fibers. *J. Acoust. Soc. Am.* **85**, 1255–1265.
- Pezalla, P.D. (1983). Morphine-induced analgesia and explosive motor behavior in an amphibian. *Brain Res.* **273**, 297.
- Raphael, B.L. (1993). Amphibians. *Vet. Clin. North Am. Small Anim. Pract.* **23**, 1271–1286.
- Schaeffer, D.O. (1997). Anesthesia and analgesia in nontraditional laboratory animal species. In “Anesthesia and Analgesia in Laboratory Animals.” (D.F. Kohn, S.K. Wixson, W.J. White, and G.J. Benson, eds.), pp 337–378. Academic Press, San Diego.
- Sladky, K.K., Swanson, C.R., Stoskopf, M.K., Loomis, M.R., and Lewbart, G.A. (2001). Comparative efficacy of tricaine methanesulfonate and clove oil for use as anesthetics in red pacu (*Piaractus brachypomus*). *Am. J. Vet. Res.* **62**, 337–342.
- Smith J.M., and Stump, K.C. (2000). Isoflurane anesthesia in the African clawed frog (*Xenopus laevis*). *Comp. Top.* **39**, 39–42.
- Stetter, M.D. (2001). Fish and amphibian anesthesia. *Vet. Clin. North Am. Exot. Anim. Pract.* **4**, 69–82.
- Stetter, M.D., Raphael, B., Indiviglio, F., and Cook, R.A. (1996). Isoflurane anesthesia in amphibians: Comparison of five application methods. *In Proc. Am. Assoc. Zoo Vet.*, pp 255–257. Mexico.
- Stevens, C.W. (2004). Opioid research in amphibians: An alternative pain model yielding insights on the evolution of opioid receptors. *Brain Res. Brain Res. Rev.* **46**, 204–215.
- Stevens, C.W., Maciver, D.N., and Newman, L.C. (2001). Testing and comparison of non-opioid analgesics in amphibians. *Comp. Top.* **40**, 23.
- Stoskopf, M.K. (1995). Anesthesia of pet fish. In “Current Veterinary Therapy. XII.” (R.W. Kirk, and J.D. Bonagura, eds.), pp 1365–1369. Saunders, Philadelphia.
- Terril-Robb, L.A., Suckow, M.A., and Grigdesby, C.F. (1996). Evaluation of the analgesic effects of butorphanol tartrate, xylazine hydrochloride, and flunixin meglumine in leopard frogs (*Rana pipiens*). *Comp. Top.* **35**, 54.
- Van Vliet, B.N., and West, N.H. (1992). Functional characteristics of arterial chemoreceptors in an amphibian (*Bufo marinus*). *Respir. Physiol.* **88**, 113–127.
- Von Esse, F.V., and Wright, K.M. (1999). Effect of intracoelomic propofol in White's tree frogs, *Pelodytes caerulea*. *Bull. Assoc. Reptil. Amphib. Vet.* **9**, 7–8.
- Wright, K.M. (2001). Restraint techniques and euthanasia. In “Amphibian Medicine and Captive Husbandry.” (K.M. Wright, and B.R. Whitaker, eds.), pp 111–122. Krieger, Malabar.
- Wright, K.M. (2006). Overview of amphibian medicine. In “Reptile Medicine and Surgery.” (D.R. Mader, ed.), pp 941–971. WB Saunders, St. Louis.

Anesthesia and Restraint of Laboratory Fish

Michael Stoskopf and Lysa Pam Posner

I. Introduction	519
II. Fish and Pain	520
III. Physical Restraint of Fish	520
IV. Basic Principles and Application of Anesthesia in Fish	521
V. Monitoring	522
VI. Anesthetic Agents	523
A. Immersion Agents	523
B. Injectable Agents	529
VII. Analgesic Agents	531
A. Opioids	531
B. Nonsteroidal Anti-Inflammatory Drugs (NSAIDs)	531
VIII. Nonchemical Methods	531
A. Hypothermia	531
B. Electroanesthesia	531
IX. Euthanasia in Fish	532
A. Suitable Methods for Euthanasia	532
B. Unsuitable Methods for Euthanasia	533
References	533

I. INTRODUCTION

Properly administered anesthesia and analgesia are particularly important in the management of fish in a research setting. Often, they are the only suitable approaches to obtaining reliable and repeatable data. The issues of the perception of pain by fish, or the level of pain that might be expected from a procedure are not the only issues to consider, and may not be the overriding factors in deciding to apply anesthesia to a fish. Proper application of anesthesia to fish spares not only the subjects but also the researchers from stresses and situations that can seriously

impact the precision and even accuracy of data from invasive procedures. Induction of anesthesia should always be considered, even for relatively minor manipulations of fish, whenever a quiet and compliant subject would improve the outcome of the research. This is equally true for very small and very large fish that present physical challenges to safe handling.

The technology of providing anesthesia to fish has taken important steps forward in the past decade, though there remains considerable opportunity for improving our understanding of the optimal approaches to providing for the comfort of fish being manipulated in research settings. One of the significant

challenges lies in the extreme diversity of the Piscean taxon. There are more distinct species of fish than of all other vertebrate taxa combined (Official Lists and Indexes of Names, 1987), and they are adapted to an amazing breadth of environmental conditions through a wide range of significant adaptations. Many of these adaptations could impact the response of a species to anesthetic and analgesic agents. Even within the relatively narrow range of teleost species routinely used in research, there are important differences in physiology that bear consideration and beg for a deeper understanding of the interactions between anesthetic agents and fish physiology. For example, some information is available regarding the impact of water temperature on the absorption of antibiotics in fish, but far less is documented about anesthetic agents. Freshwater species should be expected to absorb and excrete agents differently from euryhaline and saline species because of the radical differences in their handling of ionic homeostasis, but these differences are not well studied. Commonly used laboratory fish are generally very hardy species, often adapted to low-flow and low-quality waters in their native habitats. They respond well to routine anesthesia procedures, but fishes from pelagic and fast flowing stream habitats can be more challenging to anesthetize. A lot remains to be learned to allow optimization of anesthesia protocols across the physiological diversity of the fishes. However, the need for more knowledge should not be used as a crutch to avoid the use of anesthesia and analgesia in fish in research settings. It should rather be seen as a key reason for insisting on the application of anesthesia and analgesia at every opportunity where, with even slight adjunct effort, we might learn more about the physiology of fish responses to state-of-the-art techniques.

II. FISH AND PAIN

The International Association for the Study of Pain (IASP, 1994) defines pain as “an unpleasant sensory and emotional experience associated with actual or potential tissue damage, or described in terms of such damage.” It further states that “the inability to communicate verbally does not negate the possibility that an individual is experiencing pain and is in need of appropriate pain-relieving treatment” (IASP, 1994). According to this definition, animals do not need to communicate to experience pain, but some may argue that animals cannot have the emotional experience of pain and thus do not feel pain, but rather only react to nociception (the perception of a noxious stimuli).

Because fish lack the structure analogous to the mammalian neocortex, it has been argued that they do not feel pain. This reasoning is also used as a rationale for not providing analgesia following invasive procedures. Fish do have well-developed avoidance behavior and physical reaction to noxious stimuli (Sneddon et al., 2003), and perhaps more telling, it has been shown that fish have nociceptors that respond to pressure, prick, and heat. Stimulation of those nociceptors causes neuronal

activation to the higher brain centers, the telencephalon, in both goldfish and trout (Dunlop and Laming, 2005). Fish also have an endogenous opioid system with both kappa and mu receptors in the brain, suggestive of an evolved need for modulation of neuronal responses to complex factors including nociception (Brooks et al., 1994). All of these points, i.e., evidence of a functional neurologic pathway for nociception, reactive complex behavioral responses and learned avoidance behavior to noxious stimuli, and endogenous chemical modulation analogous to those used by mammals, suggest it is likely that fish do perceive painful stimuli. It is therefore incumbent upon investigators working with fish to provide anesthesia and analgesia for invasive and potentially painful procedures.

Evaluation of pain in fish is difficult and not well standardized. There is no single physiologic or behavioral parameter that is documented to be well correlated with pain in fish. As with terrestrial animals, a combination or matrix of behaviors and physiologic parameters needs to be evaluated. Fish in pain have been shown to change positions in the water column, show avoidance, display rocking behaviors, and have increased opercular movements and decreased appetite (Harms et al., 2005; Sneddon et al., 2003). Pain in mammals has been shown to cause adverse physiologic changes, such as increased sympathetic tone, increased cardiac demands, increased metabolic rate, and delays in healing. Allowing fish to remain in pain, besides being inhumane, should therefore be expected to affect research parameters, and should be avoided whenever possible.

III. PHYSICAL RESTRAINT OF FISH

Physical restraint of fish in laboratory settings is usually required for catching and transferring individuals or groups of fish between holding systems to experimental conditions. Though “netting” fish is considered a routine procedure, if improperly done, it can cause significant harm to the fish and to the quality of the research data obtained from the fish. These deleterious effects can be minimized by using proper catching techniques, and by appropriate selection of equipment. It should also be understood that fish can be acclimated to catch and transfer procedures using behavioral techniques very similar to those employed for mammals. When frequent transfers are expected in a laboratory, the effort to acclimate the fish to the routine is an excellent investment that will repay the scientist many times over in terms of saved time and improved data.

The use of mesh nets is not the optimal approach to catching and transferring most small fish species. A better approach does not employ nets at all, or makes use of solid net-like devices called bag nets. Even very finely meshed nets sold commercially in pet stores for handling small fish are made of relatively stiff and abrasive material, which can damage the protective mucous layer of the fish and cause very fine abrasions. The impact of abrasive nets is easier to appreciate on larger species

such as goldfish and carp. Handling these fish using nets sold commercially for fishermen or aquaculture harvesting can cause abrasions, which can often be seen with the unaided eye and may take many days to heal. Swim-through nets made from very soft mesh materials such as those used to manufacture women's pantyhose are most appropriately used for slower swimming species like koi or carp. The device consists of a hoop, usually on a handle, and a long open-ended tunnel for a bag. The fish is encouraged to swim into the net, and then the handler grasps the far end of the tunnel with one hand to close the net as the fish swims calmly down the tunnel. To release the fish after transfer, the handler merely releases the end of the tunnel and allows the fish to swim out forward, avoiding the need to flip the net or force the fish against the grain of even the fine mesh of the tunnel. These devices should be considered for use in larger fish, where capture with a bag net or box trap would result in very heavy larger volumes of water that are difficult to lift.

Bag nets and box traps should be used to capture smaller fish in laboratory settings. If properly used, they avoid forcing the fish to contact the surface of the capture device and are at least as effective and efficient in catching fish as the traditional small mesh nets sold in pet stores. Bag nets resemble traditional nets, but rather than a mesh bag, a solid, usually clear plastic bag is attached to the net frame and handle. Box traps are similar in concept, but are solid-walled containers, usually without a handle. The keys to effective techniques of catching fish for transfer or examination are patience and slow anticipatory placement of the capture device. Ideally, obstacles and hiding places should be removed from the system the fish are being caught from; however, in some cases, properly designed "furniture" or enrichment materials can be used as in situ box traps to facilitate catching species that like to hide from predators. The bag net or box trap should be maneuvered to come from behind the swimming fish. When the fish is within the perimeter of the bag or box, then the device is tilted and brought to the surface, trapping the swimming fish within a contained volume of water. Some of the water can be decanted carefully if needed, but the fish and water are then removed from the system and moved to where the fish needs to be studied or relocated. These devices can even be used for induction of anesthesia without further handling of the fish, although care should be taken to carefully rinse the devices of residual anesthetic agents before they are used again to catch fish from holding systems.

Some experimental protocols require chronic restraint of fish. These protocols may be very necessary for collecting sophisticated physiologic data from a fish. However, these protocols can be very challenging to implement in a humane manner. The nature of the species of fish and the level of acclimation of the individual fish to the situation play a large role in whether or not this type of experiment can be performed humanely without anesthesia. Species that tend to occupy crevasses and remain more or less sessile most of their day are more appropriate for these applications than schooling and more pelagic species. The restraint devices for these species can be constructed to resemble

to some degree, safe harborages, and with the constant provision of proper water quality and life support, fish can be humanely restrained sufficiently to allow various types of noncontact or minimal contact data collection for prolonged periods. Unfortunately, many research questions requiring chronic preparations focus on issues with fish unsuited to chronic restraint without anesthesia. Particularly when invasive dissection or implants are involved, these types of experiments should be conducted under anesthesia, and in cases where surgical dissections are extensive, these should not be survival procedures.

IV. BASIC PRINCIPLES AND APPLICATION OF ANESTHESIA IN FISH

The basic principles of anesthesia in fish will be quite familiar to most scientists with experience in proper anesthesia of mammals. However, it may be a bit of a surprise that many of the principles also apply to fish. If in doubt, the anesthetist should assume that principles that apply to mammals do apply to fish as well. Fish responses to anesthetic agents are affected by their physiologic state at the time of induction. A quiet, undisturbed environment prior to the induction, and calm transfers to the induction system help ensure a smoother and more efficient induction. Withholding food for 24 hours prior to the induction is not a hardship for most fish, even for very small tropical ones. While regurgitation in fish does not hold the same degree of potential for harm that is present for mammals, it can disrupt an induction or a procedure, and is easily avoided with a preanesthesia fast. Fish should be anesthetized using measured doses of the agent, and careful records of the amounts of drug and timing of application should be taken to guide future procedures and to serve as a reference when troubleshooting unexpected data results in experiments. The most successful fish anesthesiologists carefully assess fish size and condition prior to induction and select measured doses based on experience with many procedures with the species. With experience, they may be able to anesthetize several fish essentially simultaneously, and be able to observe, monitor, and record the events successfully. When anesthetizing a species of fish that you have never had experience with, it is best to limit yourself to anesthetizing one fish at a time, and it is even more important to carefully record all observations and administrations in the anesthesia record. Fish should be followed for at least 24 hours after a procedure before concluding that there were no untoward effects of the anesthesia. Selection of the induction agent will often depend on the experiments planned, but there is no substitute for experience with the agent and the species being anesthetized when it comes to having excellent results.

Essentially all routes of administration that are used in mammalian anesthesia are technically available for fish, including oral, intramuscular (IM), intravenous (IV), and intraperitoneal (IP) injection. The route of administration most commonly

used for fish anesthesia is immersion in a concentration of the anesthetic agent. The technique is analogous to the use of gas induction chambers for mammals. The agents are absorbed primarily across the gills of the fish and exert their impact centrally. Prior to placing an animal in an immersion induction solution, the recovery water should be prepared and made readily available to immediately receive a fish with an overdose or untoward reaction to the drug. Proper aeration to ensure adequate oxygenation should be maintained for both the induction and the recovery water.

Injection sites for fish vary to some degree with the fish species, but IM injections are most commonly given above the lateral line, usually in the area under the dorsal fin. IP injections are most commonly given with a needle angled forward and toward midline, entering the fish on the body wall just up from the ventral surface of the fish, between the pelvic fin and the anus. Doses of injectable drugs should be administered based on the recorded weight of the fish. Often, considering the value in reducing stress on the fish prior to induction, this is done by first estimating the weight of the fish and then actually weighing the anesthetized fish to develop a useful length-to-weight conversion table.

Once anesthetized, fish should be handled gently and with care to avoid damaging their protective mucous layer and thin skin epithelium. It is important to avoid the contact of the fish with dry surfaces, even dry human hands. Wet latex or nitrile gloves are preferable to bare hands. All surfaces that the fish directly contacts should ideally be moist and smooth. During anesthesia, fish must be supplied with adequately oxygenated water to breathe. In prolonged procedures or when fish are held in very deep planes of anesthesia that reduce respiratory effort, it may be necessary to artificially supply the needed volumes of oxygenated water to maintain the physiology of the fish. Though fish can survive their removal from water and exposure of their

gills to air, and some fish are quite adapted to this, there are physiologic consequences even for lungfish. Care should be taken to minimize the time that fish are out of water or their gills are not exposed to water.

V. MONITORING

Monitoring fish during anesthesia is a science that needs further development. In most cases, monitoring is still limited to visual observation of movement and respiratory rate and effort. Advances in the use of electrocardiographic and other physiologic monitoring are being made in larger species, but the challenge of monitoring small species remains relatively unsolved. The lack of physiologic monitoring during routine fish anesthesia contributes significantly to the many areas of ignorance that persist relative to the impact of anesthetic agents on fish physiology. Investigators with concerns about the potential impact of anesthesia on a physiologic system under study should be strongly encouraged to run pilot studies monitoring the systems they are concerned about in fish anesthetized with agents with different properties.

It is possible to categorize the stages and planes of anesthesia in fish through observation of basic swimming, respiratory, and cardiovascular patterns (Table 21-1). Many of the key responses of fish to anesthesia can be monitored with minimal or no technical assistance. Useful reflexes include the menace reflex and the righting reflex. In fact, these might better be referred to as responses rather than reflexes because of the complexity of their execution. The menace reflex of fish cannot be assessed by the closing of eyelids, of course, but fish will startle and try to move their head when an object approaches their eye. It is not necessary to touch the eye for this response. The response can be extinguished by overuse, just as occurs in mammals.

TABLE 21-1
STAGES OF ANESTHESIA

Stage	Plane	Descriptor	Behavior of fish
0		Normal	Swimming actively; reactive to external stimuli; equilibrium normal; muscle tone normal
I	1	Light sedation	Voluntary swimming continues; slight loss of reactivity to visual and tactile stimuli; respiratory rate normal; equilibrium normal; muscle tone normal
I	2	Deep sedation	Voluntary swimming stopped; total loss of reactivity to visual and tactile stimuli; slight decrease in respiratory rate; equilibrium normal; muscle tone slightly decreased; still responds to positional changes
II	1	Light narcosis	Excitement phase may precede in increasing respiratory rate; loss of tone decreased; still responds to positional changes weakly
II	2	Deep narcosis	Ceases to respond to positional changes; decrease in respiratory rate to approximately normal; total loss of equilibrium; no efforts to right itself; muscle tone decreased; some reactivity to strong tactile and vibrational stimuli; suitable for external sampling, fin biopsies, gill biopsies
III	1	Light anesthesia	Total loss of muscle tone; Responds to deep pressure; further decrease in respiratory rate; suitable for minor surgical procedures
III	2	Surgical anesthesia	Total loss of reactivity; respiratory rate very low; heart rate slow
IV		Medullary collapse	Total loss of gill movement followed by cardiac arrest in several minutes

Source: Stoskopf (1993).

The righting reflex is particularly useful for judging the induction of anesthesia by immersion. The fish is gently held in the water and turned to dorsal recumbency. Fully awake fish are difficult, if not impossible, to grasp. As induction proceeds, the fish can be held but it struggles against the manipulation of turning it on its back. With further induction, there is a delay in the time taken for the fish to coordinate its finning motions to right itself. Next, the animal becomes unable to right itself but will still make fin and body motions in an effort to do so. Finally, the fish will quietly remain in dorsal recumbency making no effort to change position, indicating a deep state of central nervous system (CNS) depression.

The respiratory rate can also be monitored with no special equipment. The rate and strength of opercular excursion can be visualized and monitored with only a timepiece that reads to the second. The accurate evaluation of the strength of opercular excursion does require some experience, particularly in observing the species of fish being anesthetized in a nonstressful awake condition to understand normal baseline gilling rates and excursion. Weak opercular motions will not be as effective at moving oxygenated water across the gill surfaces, as the shallow and ineffective respiration in mammals fails to optimize gas exchange in the lungs. During induction, gilling rates often increase initially in response to the handling and initial exposure to the chemicals, but as induction proceeds, gilling rates generally fall to normal and, with many agents, then proceed to subnormal rates and excursions.

The heart rate of fish is more challenging to monitor than the respiratory effort without some supplementation to the senses. Even for very large fish, it is challenging to visualize the movement of the relatively rigid body wall in the region of the heart. Detection of a pulse in fish is an art that has yet to be well developed. For relatively large fish, the esophageal stethoscope and modifications of the concept can be used to obtain good information about heart rate and, to some extent, depending on experience, the quality of heart contraction. The device is passed through only a very short distance to lie within the esophagus over the region of the heart. This is not yet an option in the small fish more commonly used in research facilities because of the lack of suitably sized instruments and the need for amplification. Nor are Doppler and pulse oximetry devices available that are suitably miniaturized to be used on fish as small as the gold fish or even smaller. Doppler devices designed for dogs and cats can be used effectively in moderately sized and larger fish. When external electrical signals are not a component of the experimental activity, it is possible to monitor the electrocardiogram (ECG) of fish. The conductivity of water makes it possible to achieve this monitoring without placing electrodes on the fish; however, standard ECG machines developed for mammals are not suitable for the task. Special preamplification of the electrical signals is required to obtain readable ECGs of fish in this manner (Altimiras and Larsen, 2000). Another very sophisticated way to obtain heart rate of anesthetized fish uses ultrasonography. Again, the aquatic medium makes it possible to image the heart

of fish without making direct contact with the fish. The heart rate and the quality of contractility are assessed directly by viewing real-time images of the heart. Rather high-quality probes of 10–12 MHz are required to visualize the heart of small fish effectively. Pulse oximetry, a means of monitoring oxygen saturation of blood in mammals, has not been particularly useful in fish, primarily because of the challenges of locating sensors in positions that reliably can detect pulse. Differences in hemoglobin characteristics also make calibration of the saturation information and interpretation challenging even when readings are obtained. With further advances in monitoring equipment being made, it is possible that devices suitable for more effective monitoring of fish anesthesia will become available in the future.

VI. ANESTHETIC AGENTS

There are a great number of agents available that have been used to render laboratory fish compliant for experimental manipulation. Researchers have generally had the advantage of ready access to a wide range of chemicals, and because research fish do not usually enter the human food supply, regulations designed to prevent chemical contamination of food have not inhibited the creativity of experimentalists. Over the years, a large number of chemicals and agents have been applied to fish in the hopes of inducing “anesthesia,” with varying degrees of success. However, only a few of these agents have found widespread usage sufficient to allow even a basic understanding of their effects and optimal application. We will focus our discussions primarily on those agents which are currently actively used by fish anesthesiologists for routine anesthesia of fish. Many fish “anesthetics” reported in published compilations have been used only sporadically and usually without the adjunct assessment of key physiologic impacts of the drug. For the most part, those drugs are no longer employed in fish anesthesia, although they do seem to be rediscovered on occasion. We include those agents in a secondary category of drugs that have been used but without recommendation for their use. Finally, a number of agents are listed in many compilations of fish anesthesia agents that either have little or no efficacy, have serious untoward effects on the patient, or present distinct health risks to humans in application. We mention these in a separate section of agents not recommended for use in fish anesthesia.

A. Immersion Agents

Immersion agents are those that produce anesthesia when the fish is immersed in water in which the anesthetic agent is dissolved. Although the agent must be water soluble, some agents must first be dissolved in organic solvent and then diluted with water. Concentrations are generally calculated as parts per million (ppm), which is equivalent to milligrams per liter (mg/L). Other less frequently used units may be seen in the

literature, such as grams per cubic meter of water (g/m^3) which is used when drugs are being applied to very large volumes of water. This is rarely, if ever, appropriate for anesthetizing fish in a research setting. To develop and practice good immersion anesthesia in fish, it is very important that measured doses be administered. Measured volumes of known concentration stock solutions of anesthetic should be added to measured or reasonably accurately estimated volumes of water for induction, and maintenance additions should also be carefully measured. The practice of addition of dry agent haphazardly to unmeasured volumes of water to save time is not appropriate.

Ideally, immersion agents should provide rapid immobilization and rapid recovery, and have a wide safety margin (i.e., therapeutic concentration should be much smaller than the lethal concentration). When at all possible, a separate tank should be dedicated for use with anesthetics. When using immersion agents, water quality is particularly important. Water with similar salinity, hardness, pH, dissolved oxygen, and temperature to which the fish are acclimated should be used. The ideal situation would be to use water from the tank where the fish are normally housed if that water is not seriously compromised. The anesthesia tank should be aerated, and there needs to be a method for continuous flow of water over the gills (i.e., manual movement of fish, or active flow through a tube placed near the gills, to ensure constant flow of water over the gills).

There are four stages of anesthesia for aquatic species, which are similar to anesthetic stages used in other species (Thurmon, 1996) (Table 21-1). Lighter planes of anesthesia might be acceptable when only restraint is needed. For fish undergoing painful procedures or surgery, deeper planes are required. The ideal anesthetic depth is a compromise achieving slow, steady, and effective opercular movement without response to stimulation.

The ability to rapidly recover fish from anesthesia is one of the advantages of the proper use of immersion agents; however, the pharmacokinetics of the immersion agents should be kept in mind when managing the immersion. A drug continues to be absorbed by the fish so long as the fish is maintained in a concentration of the drug in the water. This may be necessary to maintain the anesthesia, but depending upon the agent being used, the compartmentalization of drug within the fish can result in depot formation that will prolong the recovery from the anesthetic. To recover fish from immersion-induced anesthesia, the fish is placed in well-aerated, high-quality, anesthetic-free water. Manual movement of the fish through the water can be used to force water through the mouth and over the gills, to facilitate depuration of the anesthetic and delivery of oxygen to the fish. Effective use of this technique requires some experience and an understanding of the anatomy of the fish. It is quite challenging to achieve effective water movement over the gills in this manner for smaller fish. Simply opening and closing the mouth under water in a manner mimicking the motions of the awake fish can be just as effective in pumping water over the gills, and poses less risk to the patient compared to moving

the fish manually around the tank. For very small fish, this can be accomplished using a small cotton-tipped swab or similar soft device such as a microsurgical point to move the lower jaw of the fish down and back up simulating normal respiration.

Experience is a very important component of administering anesthesia and that is particularly true for immersion anesthesia of fish. Generally, anesthesia of fish should be conducted on one fish at a time, although with experience anesthesiologists can administer immersion anesthesia to large numbers of fish at one time. Even experienced fish anesthesiologists find it prudent to perform careful trials with a small number of fish one at a time when anesthetizing a new fish species they are not familiar with or when using a new agent.

1. *Best Practices Agents for Use in Fish*

- a. Tricaine methanesulfonate (3-aminobenzoic acid ethyl ester methanesulfonate: MS-222, TMS, Tricaine, Metacaine, Fiquel)

Tricaine is the only anesthetic approved by the United States Food and Drug Administration (FDA) for fish intended as food and is the most commonly used agent for the anesthesia of fish.

Chemistry. Tricaine is a white crystalline powder that has a water solubility of 1.25 g/ml at 20°C. A stock solution of 10 g/L can be stored in an airtight container at room temperature. The solution should be stored in darkened containers, as sunlight will cause the solution to turn brown. The addition of tricaine to water at relevant doses will cause the water to become acidic. At 100 mg/L, the pH of the solution can be as low 5. It is therefore recommended to buffer the solution with sodium bicarbonate to a pH between 7.0–7.5. This is most readily accomplished by supersaturating the premixed solution of MS-222 with sodium bicarbonate. This can be accomplished for stock solutions. The precipitate sometimes reported with the procedure is simply undissolved sodium bicarbonate. Care should be taken not to decant this residual when taking from the stock solution. More important to the efficacy of the stock solution is the formation of an oily substance on the surface of the solution. This occurs when the order of solution is reversed and water is buffered prior to adding the anesthetic agent to the stock solution. The same condition occurs with excessive exposure to light, which can also cause a browning of the solution. The appearance of an oily substance on the surface of the stock solution, cloudiness of the stock solution that will not settle down, or darkening of the solution all indicate that the stock solution should be discarded and new stock made. The shelf life of stock solutions can be extended by refrigeration, protection from exposure to light, and even freezing the solution. The most popular stock solution used is made up to a concentration of 10 g/L, which allows easy calculation for working in 100 mg/L dilutions.

Mechanism of action. Tricaine is a water-soluble chemical structurally related to benzocaine. It is a local anesthetic that

works by blocking the conduction of sodium channels. It is reasonable to question if the lack of movement seen in fish anesthetized with tricaine is at least partially associated with blocked conduction of muscle as opposed to true CNS depression. There is evidence of impact on nervous tissues as tricaine does decrease neural conduction in toadfish (Palmer and Mensinger, 2004). The structurally related drug, lidocaine, has also been shown to be analgesic and to function as a CNS depressant when given centrally in domestic mammals (Doherty and Frazier, 1998; Valverde et al., 2004). It is possible that tricaine may act similarly in fish.

Anesthetic effects. Tricaine is rapidly absorbed via gill diffusion, and provides a fairly rapid induction and recovery. The early stages can show some excitatory effects similar to those seen in terrestrial animals as they pass through an excitatory state (Stage II anesthesia) before becoming immobile. Once immobile, tricaine is able to completely abolish muscle movement.

Tricaine has been shown to cause physiologic changes in fish, including increased cortisol, glucose, hematocrit, and lactate (Cho and Heath, 2000). High doses (100 mg/L) of tricaine decrease dorsal aortic pressure in Chinook salmon (Hill and Forster, 2004).

Dose. There is a wide range of doses recommended for anesthesia of fish with tricaine in the literature, and this can be primarily attributed to the variety of species, fish size, and even the density of fish in a group being induced. Its wide margin of safety in most applications also plays a role in broadening the range of doses found to be “successful” in the literature. Tricaine is more potent in warm water and in soft water, and thus doses should be adjusted accordingly. Lower doses should be used for sedation or with physiologically compromised or diseased fish.

Tricaine is routinely administered at a dose between 25 and 100 mg/L for anesthesia. Most commonly used laboratory species of fish are induced quite suitably at 100 mg/L. Tricaine is used at doses between 400 and 500 mg/L for euthanasia by anesthetic overdose.

Withdrawal. Although tissue concentrations of tricaine are demonstrated to be near zero within 24 hours after administration in salmonids (Bowser, 2001), the kinetics of the drug would be expected to vary with a wide range of factors including water temperature and body composition of the fish. Therefore, the US FDA requires a 21-day withdrawal for fish used for food or release into the wild (FDA, 2005).

b. Quinaldine sulfate (2-methylquinoline: quinate)

Chemistry. Quinaldine sulfate is a crystalline powder with a solubility of 1.04 g/L in water. Stock solutions should be stored in dark containers and protected from sunlight. The

aqueous solution is acidic and should be buffered with sodium bicarbonate in a manner similar to that described for tricaine. Humans exposed to quinaldine have reported irritation to eyes and airways (Bowser, 2001).

Mechanism of action. Quinaldine has been purported to work through mechanisms similar to those postulated for tricaine (DeTolla et al., 1995), but even less is known of the exact mechanisms of action.

Anesthetic effects. Quinaldine has been used for fish anesthesia and is more commonly used for collection of fish in tide pools and coral reefs than is tricaine. In higher concentrations, it can cause a rapid induction. Recovery characteristics are more variable than with tricaine, in part because of the relatively uncontrolled dosing that occurs with the drug in some applications. Quinaldine often does not completely stop muscle movement, and many anesthetists find it more appropriate for sedation than for induction of surgical anesthesia. Long-term sedation/anesthesia has been associated with mortality (Yanar and Kumlu, 2000). Quinaldine can be an irritant to gills and cause corneal damage, particularly when administered at high concentrations for rapid immobilization in captures or when using unbuffered stock solutions administered directly onto the fish rather than mixing the stock into the anesthesia bath water (Stoskopf, 1993).

Dose. As would be expected, the dose of quinaldine varies with fish species, fish size, water temperature, and pH. Quinaldine is more effective in alkaline water, and in water with a pH < 5, quinaldine is not effective (Bowser, 2001). At comparable doses, larger fish are more heavily sedated and recovery is more prolonged in warmer water. Quinaldine is generally administered at concentrations of 15–60 mg/L to induce anesthesia or profound sedation. The most frequently used induction dose for small laboratory fish species is 50 mg/L. Species differences in response to the drug can be marked. For example, 25 mg/L will routinely cause loss of equilibrium in less than 4 minutes for salmonids, but for tilapia reported induction doses range between 50 and 1000 mg/L (DeTolla et al., 1995).

Quinaldine can be administered in combination with tricaine, and it is felt this mixture produces a faster induction. The most common ratio of administration is 10:1, tricaine:quinaldine sulfate (Rodger, 1999).

c. Imidazole anesthetics (metomidate: marinil, methomidate; etomidate: amideate, R7464)

These agents are listed in our grouping of the *best practice agents* primarily because they are used extensively as so-called “stress-free anesthesia agents”. We actually do not feel they represent *best practice agents* but they may have specific uses in certain situations. Unfortunately, the stress-free aspects

attributed to these drugs are a complete misnomer. Metomidate and etomidate block the 11-beta-hydroxylation of cortisol both in mammals and in fish. This seriously perturbs the complex positive and negative feedback pathways for control of the neuroendocrine cascade. The lack of an increase in circulating cortisol in fish given these drugs has been misinterpreted as being due to the drug-relieving stress. This is not the case. The fish are experiencing the same stress, but are not able to respond to it by producing cortisol. This misinterpretation has resulted in the misguided use of the drugs at low doses to "manage stress" in fish shipments and transports. These drugs at appropriate doses do provide a degree of immobilization and an apparent lack of reaction to noxious stimuli. However, it is important to emphasize that while plasma cortisol increases that occur when using other fish anesthetics or even in minimally handling fish do not occur with these drugs, this is a false picture of their neuroendocrine profile, which is characterized by increased levels of hormones produced by the pituitary attempting to overcome the synthetic blockade of cortisol production. Researchers should be cautious when interpreting stress response in fish exposed to imidazole anesthetics.

Chemistry. Metomidate and etomidate are imidazole compounds. Metomidate is a white powder soluble in water and ethanol. Etomidate is marketed as an aqueous solution commercially prepared in 35% propylene glycol.

Mechanism of action. Imidazole anesthetics are gamma-aminobutyric acid (GABA) receptor agonists that produce anesthesia and amnesia in mammals (Stoelting, 1999). They are poor muscle relaxants and provide no analgesia. The efficacy of imidazoles in fish is greater in more alkaline water, and therefore doses should be decreased with increasing pH of the water.

Anesthetic effects. Imidazole anesthetics have a wide safety margin in fish and produce a rapid induction with a more prolonged recovery than induction, and these rates are dose dependent (Amend and Goven, 1982). Metomidate at high concentrations (6–10 mg/L) is reported to cause no change in heart rate, cardiac output, dorsal aortic pressure, or stroke volume in Chinook salmon (Hill and Forster, 2004), but little physiologic data is published on the effects on commonly used research fish species. The effects reported in salmon are similar to what has been reported in humans and other mammals (Stoelting, 1999). As mentioned earlier, metomidate has been suggested to block the stress response. Imidazole anesthetics (e.g., metomidate and etomidate) interrupt cortisol synthesis in mammals by suppressing the enzyme 11-beta-hydroxylase, which is necessary for cortisol production (Stoelting, 1999). Fish exposed to metomidate can have dark skin discoloration after exposure. Because cortisol inhibits the release of ACTH and ACTH stimulates the melanocyte-stimulating hormone, it is hypothesized

that the decrease in cortisol production that occurs with the use of these drugs results in an increase in melanocyte-stimulating hormone (Harms and Bakal, 1994). Normal color returns after recovery from the anesthetic. Metomidate has been successfully used as an immersion agent, but has also been used successfully to anesthetize turbot and halibut when used intravenously and orally (Hansen et al., 2003).

Doses. Metomidate: 0.5–10 mg/L; 3 mg/kg IV; 7 mg/kg, oral (Hansen et al., 2003). Etomidate: 2–20 mg/L.

d. Eugenol [4-allyl-2-methoxy-phenol: clove oil, isoeugenol, AQUI-S (2-methoxy-4-propenyl phenol)]

AQUI-S is a 50% eugenol solution that is approved for use in fish in Australia, New Zealand, Chile, and Korea, where it has no withdrawal time for fish destined for human consumption or release to the wild. The active ingredient, eugenol, is classified by the FDA as GRAS (generally regarded as safe), but the use of the compound for anesthesia of food fish is not approved.

Chemistry. Eugenol is a pale yellow liquid from the tree *Eugenia aromatica*. It is poorly water-soluble and must be dissolved in ethanol (1:9) before dilution into water. The proprietary formulation of AQUI-S is sufficiently soluble to allow direct addition to induction water.

Mechanism of action. The mechanism of action of eugenol in fish is unknown, but it has been used extensively as a topical anesthetic in human dentistry, and its mechanism of action may be similar to that of other local anesthetics (e.g., tricaine, lidocaine).

Anesthetic effect. Eugenol can cause immobility in fish. In Chinook salmon, a high dose (60 mg/L) of anesthesia with eugenol is accompanied by a decrease in heart rate, cardiac output, dorsal aortic pressure, and stroke volume (Hill and Forster, 2004). Anesthesia with eugenol is reported to cause a 75% decrease in arterial oxygen (PaO₂) in fish (Hill and Forster, 2004), and an increase in catecholamines, glucose, and hematocrit (Cho and Heath, 2000; Hill and Forster, 2004; Sladky et al., 2001). It is possible that what appear as depression to the CNS are the effects of hypoxemia.

Dose. Eugenol: 25–60 mg/L; AQUI-S: 20–60 mg/L.

2. Infrequently Used Agents in Fish

a. Benzocaine (ethyl aminobenzoate: anesthesin, anesthone, ethyl aminobenzoate, orthesin, parathesin)

Benzocaine is commonly used as a local anesthetic for humans (e.g., cough drops, sunburn aid). It is structurally

similar to tricaine, but lacks the sulfate moiety of tricaine, which renders the latter to be highly soluble in water. Benzocaine has been used to produce anesthesia and for euthanasia. There is no particular benefit of this agent over the closely related and FDA-approved tricaine. The investigators should be guided to use tricaine unless there is a specific reason that drug would interfere with the data being collected. The similarities between the drugs would make this a very rare situation.

Chemistry. Benzocaine occurs in two forms: a crystalline salt (benzocaine HCl) that is soluble in water at 0.4 g/L, and a nonwater-soluble basic form that must be dissolved in ethyl alcohol at a concentration of 0.2 g/ml before it is sufficiently soluble in water to create a functional induction dose. The HCl salt of benzocaine can be prepared as a stock solution of 100 g/L, which should be stored in a dark container and protected from light. As with tricaine, benzocaine should be buffered with sodium bicarbonate to raise the pH to 7.0–7.5.

Mechanism of action. Benzocaine is a local anesthetic that blocks sodium channel conduction.

Anesthetic effects. Benzocaine produces a fairly rapid induction and recovery from anesthesia. However, even at high doses, fish may retain some locomotor activity. Respiration is rapidly depressed. Benzocaine is highly fat soluble, so obese or gravid females may have prolonged recoveries.

Dose. Wide dose range reflects different species, size, water temperature, and water hardness. Anesthesia can be accomplished with concentrations between 25 and 200 mg/L. Euthanasia can be accomplished with 3–5 times the concentration needed to produce anesthesia.

b. Lidocaine (xylocaine, lignocaine)

Lidocaine is generally not considered as suitable an immersion agent as tricaine, although it is used commonly for local injectable analgesia. Investigators seeking to use this drug for general anesthesia of their fish should be directed to the use of tricaine unless there is a specific demonstrated reason to believe that tricaine would interfere with the quality or usefulness of the data collected.

Chemistry. Lidocaine is available in two forms: a hydrochloric salt that is water soluble and a non-water-soluble basic form that must be dissolved in acetone or alcohol before diluting in water.

Mechanism of action. Lidocaine is a local anesthetic that blocks sodium channel conduction (see information on tricaine).

Anesthetic effect. Lidocaine produces a quick induction but long recovery and causes cardiovascular depression. Increased efficacy and decreased toxicity are seen when lidocaine is administered with sodium bicarbonate (Carrasco et al., 1984).

Dose. Lidocaine has been administered at 250–350 mg/L with 1 g/L of sodium bicarbonate.

c. Volatile anesthetics (halothane, isoflurane, sevoflurane)

Although these agents are well studied in mammals and do work through mechanisms that would be expected to induce analgesia and anesthesia in fish, the challenges of their proper safe use and achieving appropriate induction times with currently available technology keep them from being placed in the category of “*best practice agents*.”

Chemistry. Volatile anesthetics are lipophilic and do not always mix well with water. They can be added to the water tank or distributed into the water by spraying the solution using a syringe with a 25 g needle. Alternatively, it can be bubbled through the water with oxygen through an anesthetic vaporizer (Stetter, 2001).

Mechanism of action. Volatile anesthetics produce anesthesia, analgesia, and amnesia by activating the inhibitory neurotransmitter GABA receptors in the CNS. Activation of GABA receptors causes postsynaptic hyperpolarization which prevents ascending neural transmission. It is also likely that volatile inhalants block the activation of the excitatory neurotransmitter glutamate.

Anesthetic effect. Induction can be slow with the excitement stages observed. It is likely that the slow induction is due to the difficulty in reaching therapeutic concentrations in water because the volatile agents are continually being vaporized and lost to the environment. At therapeutic concentrations, immobility can be reached and recovery is quick following removal from anesthetic exposure (Stetter, 2001).

Dose. Isoflurane: 0.25–0.75 ml/L (Stetter, 2001).

Fish require similar inhalant concentrations as mammals to be effective (similar minimum alveolar concentration, MAC) (Steffey, 1996). However, dosing is imprecise as agents are highly volatile and vaporize quickly. This causes significant changes to the water concentration and can increase atmospheric concentrations exposing laboratory personnel to the anesthetic.

The ability to scavenge vaporized liquid is required. Due to imprecision of dose and the exposure to humans, and the need to scavenge waste gas, this method of anesthesia is rarely suitable for the laboratory setting without highly specialized equipment.

3. *Inappropriate Agents for Use in Fish*

a. Propanidid (epontol, sombrevin)

This drug is an ultra-short-acting, nonbarbiturate, general anesthetic that was used successfully in human medicine until it was prohibited from sale in the 1980s following anaphylactic reactions.

Chemistry. Propanidid is insoluble in water, and thus must first be dissolved in alcohol to a 5% stock solution before adding to water.

Mechanism of action. Propanidid is presumed to work as a GABA receptor agonist, but its mechanism of action in fish is unknown.

Anesthetic action. Propanidid produces short- and long-term anesthesia. The data with those reports are insufficient to establish whether or not anesthesia and analgesia are achieved. Application of the drug is associated with significant respiratory and metabolic acidosis, with minimal changes to blood chemistry (Thorsteinsson, 2002).

Dose. Propanidid is administered at 1.5–3 ml/L of an unspecified stock solution. There is no compelling reason to pursue this compound as a fish anesthetic.

b. Phenoxyethanol [2-phenoxyethanol phenyl ether: phenyl cellosolve, phenoxethol, 2-phenoxyethanol (2-PE)]

Due to a low therapeutic index, and the potential for cardiovascular and toxic effects, phenoxyethanol is a poor choice as anesthetic.

Chemistry. Phenoxyethanol is an organic compound that has a water solubility of 27 g/L at 20°C. It is a topical irritant, and care should be taken to protect human skin and eyes from contact. There is no reason to believe it is any less irritating to fish tissues, and thus application should only occur by exposing fish to the lowest dilution needed for effect.

Mechanism of action. Mechanism of action of phenoxyethanol is unknown in fish.

Anesthetic action. Phenoxyethanol causes rapid induction and recovery; however, fish may maintain muscle movement. Cardiovascular parameters are depressed, and there is potential for liver, kidney, and corneal damage. Fish may show initial hyperactivity when first exposed, which is different from the excitement of Stage II anesthesia and most likely attributable to the irritant properties of the chemical.

Dose. Phenoxyethanol is rarely used in modern research, and investigators should be directed to use other drugs such as tricaine.

c. Carbon dioxide (CO₂)

CO₂ has a long history of use for sedation/anesthesia of fish. It is inexpensive and can be delivered as a gas bubbled from compressed gas tanks via air stones, or generated by use of bicarbonate-of-soda antacids, in field situations. Approximately 200 mg/L of it is needed to immobilize fish. However, the generation of CO₂ simultaneously displaces oxygen and increases the acidity of water. The combination would not be expected to be physiologically benign for the fish. Very high concentrations of CO₂ are required for sedation/anesthesia in mammals, and it is unlikely that CO₂ produces analgesia. Therefore, CO₂ should not be considered as an appropriate agent for anesthesia of fish.

4. *Not Recommended for Use in Fish*

a. Diethyl ether

Diethyl ether has a long history in human and veterinary medicine as an anesthetic. Although it produces reliable anesthesia in mammals, it is extremely flammable. Its vapors are denser than air, and will accumulate if proper ventilation is not present. Simple static electricity can ignite the ether vapors. Diethyl ether should only be used inside a fume hood, and thus is not recommended for use in fish anesthesia.

b. Chloral hydrate

Chloral hydrate is a sedative that has been used extensively in veterinary medicine, particularly in equine patients. It produces sedation and muscle relaxation but does not produce analgesia or anesthesia, and therefore it is not recommended as an anesthetic agent for fish.

c. Urethane

Urethane has previously been used in the laboratory setting to anesthetize laboratory animals and fish. However, urethane is an established animal carcinogen and has been classified as “reasonably anticipated to be a human carcinogen” (Program, 1983), and thus should be not used in the routine laboratory setting.

d. Halothane

Halothane is a volatile anesthetic that has been used extensively in human and veterinary medicine, and can be used successfully to anesthetized fish. In people, hepatitis has been reported following exposure to halothane (Stoelting, 1999). As discussed previously, anesthesia of fish produces a significant amount of environmental exposure to the agent. Thus, halothane

is not recommended for this purpose due to the risks associated with human exposure.

e. Chlorobutanol

Chlorobutanol has been used successfully to anesthetize fish, but has been reported to be toxic in small fish (Canadian Council on Animal Care, 2005). It poses human health hazards as it is irritating to skin and eyes. Inhalation of large quantities can cause unconsciousness (Thorsteinsson, 2002). Since it provides no benefit over other available agents, it is not recommended for use.

B. Injectable Agents

Injectable agents can be used successfully in fish intramuscularly or intravenously. This method does require either fish handling before anesthesia which can increase stress, or the ability to dart or pole-syringe fish. For the researcher who needs to anesthetize a large number of fish or routinely anesthetize fish, this method may be less advantageous than immersion agents.

1. Best Practices Agents

a. Ketamine (ketaject, ketaset)

Chemistry. Ketamine is a white crystalline powder. One gram of ketamine is soluble in 5 ml water or 14 ml alcohol. Commercially prepared ketamine is a water-soluble liquid with a pH of 3.5–5.5.

Mechanism of action. Ketamine is an *N*-methyl-D-aspartate (NMDA) antagonist that produces dissociative anesthesia by dissociating the thalamo-cortical and limbic systems. In mammals, it produces anesthesia and provides analgesia. It has been suggested that ketamine provides better somatic than visceral analgesia, but this distinction is inaccurate. NMDA antagonists has been shown to interrupt pain transmission in the dorsal horn of the spinal cord, mediating somatic, visceral, neuropathic and orthopaedic pain, often at subanesthetic doses (Visser and Schug, 2006).

Anesthetic effects. Administration of ketamine is most commonly accomplished with an IM injection, although the anesthetic effects are more reliable intravenously. As in terrestrial mammals, following administration of ketamine, fish may struggle or show excitement during the early stages of anesthesia. During deeper anesthesia, muscle relaxation may still be poor when ketamine is used alone. Muscle relaxation may be improved by the addition of an alpha-2 agonist (e.g., xylazine). Ventilation is minimally affected with ketamine alone, but may be decreased when used in combination with an alpha-2 agonist in sturgeon (Fleming et al., 2003).

Dose. Ketamine can be administered at 30 mg/kg IV (anesthesia <3 min) or 10–80 mg/kg IM. The very wide range of IM doses is indicative of the relatively sparse research on the efficacy and safety of this agent. As with other animals, it does appear to have a wide margin of safety, and there may be significant interspecies differences in susceptibility. Another factor that affects the required dose is the level of excitement of fish at the time of injection.

b. Alpha-2 agonists (e.g., xylazine, dexmedetomidine, medetomidine)

Chemistry. Alpha-2 agonists are crystalline substances that are water soluble.

Mechanism of action. Alpha-2 agonists bind and activate alpha-2 adrenergic receptors, resulting in sedation and analgesia. At least five alpha-2 receptors have been identified in zebrafish (Ruuskanen et al., 2005).

Anesthetic effects. Zebrafish show a dose-dependent decrease in locomotion following dexmedetomidine administration (Ruuskanen et al., 2005). It is possible that activation of alpha-2 receptors might also provide analgesia as it does in mammalian species.

Alpha-2 antagonists (e.g., yohimbine, atipamezole) are effective reversal agents (Williams et al., 2004).

Dose. Medetomidine 0.06–4.0 mg/kg IM (given with ketamine).

c. Propofol

Chemistry. Propofol is an alkyl-phenol commercially available as an emulsion with a pH of 7–8.5.

Mechanism of action. Propofol is a GABA receptor agonist that produces anesthesia in mammals (Stoelting, 1999). It provides good muscle relaxation but no analgesia.

Anesthetic effects. In sturgeon, propofol produced light anesthesia accompanied with respiratory depression and bradycardia (Fleming et al., 2003).

Dose. 3.5–7.5 mg/kg IV (Fleming et al., 2003).

2. Infrequently Used Agents

a. Alphaxalone–alphadolone (saffan, althesin)

This agent is a steroid anesthetic not available in the United States, but commonly used in Europe and Australia in dogs and cats. The older formulation had a Cremophor base and could cause histamine release with swelling, pruritus, and edema. The

newer formulation (Alphaxalone CD) is alphaxalone only and does not contain the Cremophor base.

Chemistry. Saffan is a poorly water-soluble synthetic steroid. Each milliliter contains 9 mg alphaxalone plus 3 mg alfadolone.

Mechanism of action. Steroid anesthetics activate the inhibitory GABA receptor producing anesthesia and muscle relaxation.

Anesthetic action. Alphaxalone–alfadolone can produce sedation and anesthesia in a variety of fish. At higher doses, the induction is fairly rapid (within 5 minutes) but recovery to normal swimming can take up to 5 hours (Harvey et al., 1987).

Dose. 0.3–1.5 ml/kg IM.

b. Azaperone (suicalm, stressnill)

Azaperone is a butyrophenone neuroleptic sedative/hypnotic that is related to the drug haloperidol used in people with psychiatric disorders. Azaperone has been extensively used in pigs to prevent fighting and stress.

Chemistry. The commercial form is available in an aqueous solution at 40 mg/ml.

Mechanism of action. Butyrophenones are dopamine (D2) receptor antagonists. They also have agonist effects at serotonin receptors and block activation of the reticular activating system.

Anesthetic action. Azaperone does not produce anesthesia or analgesia but can be used as an anxiolytic. Fish administered with azaperone do not show stress behaviors when netted or moved to a new environment (Latas, 1987).

Dose: 4 mg/kg directly onto gills.

c. Barbiturates (pentobarbital, thiopental)

The barbiturates are often reported as potential fish anesthetics in reviews, but apparently have only very rarely been applied. They have been used on occasions to euthanize fish. Little actual experience with these drugs in fish is reported in the literature.

Chemistry. These drugs are all derived from barbituric acid. They are commercially available in aqueous solutions with a basic pH. They are a class II controlled drug in the United States.

Mechanism of action. Barbiturates are commonly used anesthetics in mammals. They cause anesthesia by activation and enhancement of GABA receptors in the CNS producing unconsciousness and amnesia.

Anesthetic effects. It is possible to use barbiturates intravenously in larger fish, but the difficulty of restraining larger fish for IV injections makes this technique less useful for routine anesthesia in research fish.

Dose. Thiopental 10–30 mg/kg IM; Pentobarbital 30–72 mg/kg IM.

d. Diazepam

Diazepam has been used as an oral as well as an injectable agent to sedate individual fish for safer handling and at lower doses to stimulate appetite. It has been used effectively as a sedative in larger groups but does not induce general anesthesia or even mobility at the doses that have been applied. Published data on the effects of this drug on fish species commonly used in research laboratories is not readily available.

Chemistry. Diazepam has a water solubility of 3 g/L. The commercially available liquid is 5 mg/ml with a vehicle that is 40% propylene glycol and 10% ethanol. It is a Schedule IV controlled drug.

Mechanism of action. Diazepam is a benzodiazepine that produces sedation by activating GABA receptors in the CNS.

Anesthetic effects. Diazepam produces muscle relaxation and CNS depression, but does not produce anesthesia or provide analgesia. This type of drug is best used in conjunction with other anesthetics and/or analgesics.

Dose. 1–4 mg/kg IM.

e. Gallamine triethiodide (Flaxedil)

Gallamine is a competitive, nondepolarizing neuromuscular blocker (NMB) that has been extensively used to immobilize alligators and crocodiles as well as fish.

Chemistry. Gallamine is supplied as 2% solution of gallamine triethiodide, which needs to be protected from light.

Mechanism of action. NMBs work by blocking the binding of acetylcholine to its receptor at the neuromuscular junction causing paralysis of skeletal muscle. Neuromuscular blockers do not produce any CNS depression or provide any analgesia. It is considered inhumane and unacceptable to administer NMB without a CNS depressant to mammals and should be considered just as unacceptable for single agent use in fish.

Anesthetic action. Although NMBs do not provide sedation or analgesia, they do provide immobility and chemical restraint.

The paralysis of skeletal muscle can affect the muscles used for respiration. The NMB, succinylcholine, can cause complete cessation of respiration and death when used in fish. Gallamine does appear to preserve gilling when properly dosed. Its use alone in a painful procedure cannot be recommended.

Dose. Gallamine: 1–3 mg/kg IM.

3. *Regional Anesthesia (Lidocaine, Bupivacaine)*

Local anesthetics prevent the cranial migration of pain perception by blocking sodium channel conduction. Local anesthetics can be used in fish as adjunct to general anesthesia or in place of it. If the fish is not anesthetized, the injection of local anesthetic can be painful and the manual restraint needed can be stressful.

Dose. Lidocaine 4–10 mg/kg.

VII. ANALGESIC AGENTS

A. Opioids

There is evidence for the presence of mu and kappa opioid receptors in teleost fish (Alvarez et al., 2006; Darlison et al., 1997). This implies an endogenous opioid system that might be manipulated to provide analgesia for research fish.

1. *Butorphanol*

Butorphanol is a kappa opioid agonist that results in sedation and analgesia in mammals. The use of butorphanol (0.4 mg/kg IM) in koi carp (*Cyprinus carpio*) preoperatively prevents behavioral changes (Harms et al., 2005), suggesting either decreased pain or stress or both. Butorphanol is a Schedule IV controlled drug.

2. *Morphine*

Morphine is a mu opioid agonist that results in analgesia and sedation in mammals. Morphine (5 mg/kg) has been shown to attenuate postsurgical behaviors and decrease operculum rate in rainbow trout following a noxious stimulus (Sneddon, 2006; Sneddon et al., 2003). Naloxone has been shown to block responses seen with administration of morphine. Morphine is a Schedule II controlled drug.

B. Nonsteroidal Anti-Inflammatory Drugs (NSAIDs)

NSAIDs are commonly used drugs in human and veterinary medicine. Ketoprofen (2 mg/kg IM) did not prevent behavioral changes following noxious stimuli in koi carp, but did attenuate

the changes to creatine kinase indicating a diminished muscle injury (Harms et al., 2005).

VIII. NONCHEMICAL METHODS

A. Hypothermia

Arguments are frequently given for the use of hypothermia as an immobilizing method and even as an anesthetic for fish. The question is quite complex, and based primarily on extrapolation of data from other species including humans. Many of the fisheries-based investigators inappropriately equate anesthesia with immobilization, and little, if any, work has been published assessing the actual issues looking at this method of hypothermic analgesia or anesthesia in fish (Hovda, 2000). Earlier work evaluating the physiologic impacts of lethal and sublethal hypothermia on fish suggests that extreme caution be used in considering this approach. Research has shown that expected electrolyte and fluid shifts in tissues occur in fish exposed to acute and chronic temperature shifts, and that the rate of application of hypothermia, the acclimation temperature of the fish being induced, as well as the temperature being applied as the endpoint of hypothermia affect survival and a wide range of physiologic and biochemical processes in fish (Elliott, 1981; Houston et al., 1968; Mark et al., 2002). While the ability of hypothermia to immobilize fish is clearly established, there is insufficient evidence to suggest that the process provides anesthesia or analgesia.

Hypothermia applications in humans are frequently cited as a basis for the use of the method in fish, but it should be pointed out that humans subjected to surgical hypothermia to reduce the impacts of hypoxia in certain types of surgery are under general anesthesia before the technique is applied. Humans experiencing hypothermia resulting in frostbite while conscious generally report severe pain followed by localized numbness before hypoesthesia occurs (Berg et al., 1999). Rewarming of tissue has also been described as painful. Further investigation into the impact on neural processing and the detailed impacts of the application of the technique is needed before hypothermia can be an accepted means of providing anesthesia for fish used in research.

B. Electroanesthesia

Our understanding of electroanesthesia remains rudimentary. The method immobilizes fish rapidly and hence has been recommended for minor procedures particularly where large numbers of fish are involved (DeTolla, 1995) and very specialized equipment has been developed for the application of electroanesthesia in wild fish for large-scale management assessments (United States Patent 5305711). Studies on salmonids have shown that

electroanesthesia is a good alternative to MS-222 for short-duration (<1 minute) immobilization (Gunstrom and Bethers, 1985; Orsi and Short, 1987; Sterritt et al., 1994) and the use of electroanesthesia offers quick recovery of immobilized fish (Gunstrom and Bethers, 1985).

Research in the area of human pain relief and anesthesia reflected a major interest in the potential for electroanesthesia and analgesia in the late 1960s to early 1970s, and mechanistic assessments of the techniques began at that time. However, the evaluation of electroanesthesia in fish suffers from the same problems seen in the evaluation of other anesthetic modalities for fish. Sophisticated physiologic assessments of anesthetized fish are fairly rare. The reliance on plasma cortisol concentrations as a measure of anesthetic quality is fraught with challenges, and there is an important need to determine standardized multifaceted methods for assessing quality in fish. Recent studies comparing electroanesthesia and chemical anesthesia in juvenile Japanese eel (*Anguilla japonica*) provide a good example (Chiba et al., 2006). The researchers looked at the impact on plasma cortisol concentrations of eels anesthetized using one of the several protocols used in electroanesthesia and electroshocking (100 V, 2A—AC or 240 V, 6A—AC applied for 30 seconds and 500 V, 5A—DC or 1,000 V, 5A—DC pulsed for 30 seconds). These results were compared to the effects of the chemical anesthetics 2-PE and tricaine methanesulfonate (MS-222) on plasma cortisol concentrations. Plasma cortisol concentrations similar to those observed in eels anesthetized with 2-PE, and somewhat elevated over what might be expected as baseline cortisol levels based on studies in other fish species, were observed in eels anesthetized with the lowest voltage method (100 V). These results on their own would have been consistent with the findings of earlier studies in goldfish using MS-222 anesthesia to compare with electroanesthesia (Singly and Chavin, 1975). However, the investigators noted that the plasma cortisol concentrations in eels exposed to low voltage were significantly elevated over the levels found in eels anesthetized with the higher voltage AC or DC electroanesthesia methods, possibly supporting a conclusion that higher voltages provide better anesthesia. Equally perturbing were the results of the MS-222 anesthetized eels, which showed the highest plasma cortisol concentrations of all groups studied. This disparity, however, was most likely due to a quirk in the sampling protocols where blood samples were drawn as soon as the fish were deemed anesthetized rather than at a set time point after initiation of induction with the chosen agent. As in other vertebrate species, there is a time lag in the response of elevated circulating cortisol concentrations and this time lag varies among fish species to some degree. The use of high voltage caused a much more rapid induction, allowing plasma samples to be obtained much earlier after initial exposure than when the 100-V method was employed. Similarly, the induction time for MS-222 in the protocol used in the study was much longer than the 2-PE induction time, likely explaining much higher cortisol concentrations in MS-222 anesthetized eels. The investigators saw increases in

plasma cortisol concentrations over time in eels anesthetized with electroanesthesia supporting this supposition. However, the same is true of eels anesthetized with chemical anesthesia. Eels, in particular, require much higher levels of chemical anesthesia for induction than most other teleost fish, and their response to exposure to these agents should not be ignored when comparing the efficacy of electroanesthesia, particularly for extrapolation to other fish groups.

IX. EUTHANASIA OF FISH

The goal of euthanasia of fish is the same as in all other species (AVMA Panel on Euthanasia, 2001). It should be performed quickly, humanely, and with minimal stress to the animal. The unique differences in fish anatomy, physiology, and metabolism need to be addressed when designing a plan for euthanasia. Euthanasia may be accomplished by drug overdose or physical methods. Unfortunately, many unsuitable methods have been proposed and used in fish species.

A. Suitable Methods for Euthanasia

1. Chemical Overdose

Fish should be placed in water with anesthetic agents sufficient to quickly anesthetize and then euthanize the fish (AVMA Panel on Euthanasia, 2001). The fish should be left in treated water for 10 minutes after movement has stopped.

Tricaine: 400–500 mg/L.

Benzocaine: >250 mg/L.

Phenoxyethanol: 0.5–0.6 mg/L.

Pentobarbital: 60–100 mg/kg IV or IP.

a. CO₂

CO₂ has been used to sedate and euthanize fish. It has been applied by bubbling the gas through water using airstones or by chemical generation of CO₂ in the water. CO₂ euthanasia is accepted with caveats as humane in mammals (AVMA Panel on Euthanasia, 2001). Further research should be conducted on this agent and its impacts on fish. The common product, Alka-seltzer™, and other carbonating antacids when added to water produce CO₂. At high levels, CO₂ does produce CNS depression, however, in a tank atmosphere; it is more likely that the fish die from hypoxemia.

2. Physical Methods

a. Decapitation

Decapitation is an acceptable form of euthanasia, but because fish are tolerant to hypoxia, decapitation should be followed by pithing to quickly stop brain activity. Because of differences

in anatomy and difficulty in restraint, decapitation and pithing should be conducted by a person experienced in the techniques. When possible, decapitation should be performed following induction of anesthesia.

b. Cranial concussion

Cranial concussion is an acceptable method of euthanasia. Unfortunately, some fish recover consciousness, and thus cranial concussion should be followed by decapitation, exsanguination, or pithing. The procedure should be conducted by a person experienced in the proper application of the technique in the species being euthanized. When possible, cranial concussion should be performed following induction of anesthesia.

B. Unsuitable Methods for Euthanasia

1. Cooling

Although cooling ectotherms will decrease movement and metabolism, there is no evidence that it provided anesthesia or analgesia. Many fish species are tolerant to cold and freeze. Euthanasia by cooling/freezing should be considered inhumane.

2. Asphyxia

Asphyxia is not recommended due to the extended period of time required for the fish to lose consciousness. Furthermore, certain fish are resistant to hypoxia, and therefore the time to death can be quite prolonged.

3. Formalin Immersion

It is quite unfortunate that formalin immersion of live fish has been cited as an appropriate method for euthanasia of fish in a number of publications including guidelines from scientific societies that should be more cautious in their recommendations. The technique cannot be considered humane and should not be employed even when logistical challenges of field conditions are involved. Fish immersed in 10% buffered formalin immediately exhibit extreme distress behaviors, rapid gilling, and efforts to escape the solution, as would be predicted considering the irritant properties of formalin. They survive in the solution far longer than would be expected, in some cases for many hours (Stoskopf, personal observation). This technique should not be condoned.

REFERENCES

- Altimiras, J., and Larsen, E. (2000). Non-invasive recording of heart rate and ventilation rate in rainbow trout during rest and swimming. *Fish go wireless! J. Fish Biol.* **57**, 197–209.
- Alvarez, F.A., Rodriguez-Martin, I., et al. (2006). New kappa opioid receptor from zebrafish *Danio rerio*. *Neurosci. Lett.* **405**(1–2), 94–99.
- Amend, D.F., Goven, B.A., et al. (1982). Etomidate: Effective dosages for a new fish anesthetic. *Trans. Am. Fish. Soc.* **111**, 337–341.
- AVMA Panel on Euthanasia. (2001). Report of AVMA Panel on Euthanasia. *JAVMA* **218**, 669–696.
- Berg, A., Aas, P., et al. (1999). Lokale frostskafer. *Tidsskr. Nor. Laegeforen.* **119**(3), 382–385.
- Bowser, P. (2001). Anesthetic option for fish. In “Recent Advances in Veterinary Anesthesia and Analgesia: Companion Animals.” (R. Gleed and J. Ludders, eds.). International Veterinary Information Service, Ithaca, NY; <http://www.IVIS.org>.
- Brooks, A.I., Standifer, K.M., et al. (1994). Opioid binding in giant toad and goldfish brain. *Receptor* **4**(1), 55–62.
- Carrasco, S., Sumano, H., and Navohro-Fierro, R., (1984). The use of lidocaine-sodium bicarbonate as an anesthetic in fish. *Aquaculture* **41**, 161–163.
- Canadian Council on Animal Care. (2005). Anesthetic and sedative drugs dosages fishes. Canadian Council on Animal Care; http://www.ccac.ca/en/CCAC_Programs/Guidelines_Policies/GUIDES/ENGLISH/VI_93/APPEN/APPXIII.HTM.
- Chiba, H., Hattori, T., et al. (2006). Comparison of the effects of chemical anesthesia and electroanesthesia on plasma cortisol levels in the Japanese eel *Anguilla japonica*. *Fish. Sci.* **72**, 693–695.
- Cho, G.K., and Heath, D.D. (2000). Comparison of tricaine methanesulphonate (MS222) and clove oil anaesthesia effects on the physiology of juvenile chinook salmon *Oncorhynchus tshawytscha* (Walbaum). *Aquaculture Res.* **31**, 537–546.
- Darlison, M.G., Greten, F.R., et al. (1997). Opioid receptors from a lower vertebrate (*Catostomus commersoni*): Sequence, pharmacology, coupling to a G-protein-gated inward-rectifying potassium channel (GIRK1), and evolution. *Proc. Natl. Acad. Sci. U.S.A.* **94**(15), 8214–8219.
- DeTolla, L., Srinivas, S., et al. (1995). Guidelines for the care and use of fish in research. *ILAR J.* **37**(4). Available at: http://dels.nas.edu/ilar_n/ilarjournal/37_4/37_4Guidelines.shtml.
- Doherty, T.J., and Frazier, D.L. (1998). Effect of intravenous lidocaine on halothane minimum alveolar concentration in ponies. *Equine Vet. J.* **30**(4), 300–303.
- Dunlop, R., and Laming, P. (2005). Mechanoreceptive and nociceptive responses in the central nervous system of goldfish (*Carassius auratus*) and trout (*Oncorhynchus mykiss*). *J. Pain* **6**(9), 561–568.
- Elliott, J. (1981). “Some Aspects of Thermal Stress on Freshwater Teleost.” Academic Press, London.
- FDA. (2005). Database of approved animal drug products. <http://dil.vetmed.vt.edu/Display/NadaBrowse.cfm?NadaString=200-226>.
- Fleming, G.J., Heard, D.J., et al. (2003). Evaluation of propofol and medetomidine-ketamine for short-term immobilization of Gulf of Mexico sturgeon (*Acipenser oxyrinchus desotii*). *J. Zoo Wildl. Med.* **34**(2), 153–158.
- Gunstrom, G., and Bethers, M. (1985). Electrical anesthesia for handling large salmonids. *Prog. Fish-Culturist* **47**, 67–69.
- Hansen, M.K., Nymoen, U., et al. (2003). Pharmacokinetic and pharmacodynamic properties of metomidate in turbot (*Scophthalmus maximus*) and halibut (*Hippoglossus hippoglossus*). *J. Vet. Pharmacol. Ther.* **26**(2), 95–103.
- Harms, C.A., and Bakal, B. (1994). Techniques in fish anesthesia. Proceedings of the American Association of Zoo Veterinarians and Association of Reptilian and Amphibian Veterinarians.
- Harms, C.A., Lewbart, G.A., et al. (2005). Behavioral and clinical pathology changes in koi carp (*Cyprinus carpio*) subjected to anesthesia and surgery with and without intra-operative analgesics. *Comp. Med.* **55**(3), 221–226.
- Harvey, B., Denny, C., Kaiser, S., and Young, J. (1987). Remote intramuscular injection of immobilizing drugs in to fish using a laser-aimed underwater dart gun. *Proc. Int. Assoc. Aquatic Anim. Med.* **18**, 144–152.
- Hill, J.V., and Forster, M.E. (2004). Cardiovascular responses of Chinook salmon (*Oncorhynchus tshawytscha*) during rapid anaesthetic induction and recovery. *Comp. Biochem. Physiol. C Toxicol. Pharmacol.* **137**(2), 167–77.

- Houston, A.H., Reaves, R.S., et al. (1968). Environmental temperature and the body fluid system of the fresh-water teleost. I. Ionic regulation in thermally acclimated rainbow trout, *Salmo gairdneri*. *Comp. Biochem. Physiol.* **25**(2), 563–581.
- International Association for the Study of Pain. (1994). “Classification of Chronic Pain.” IASP Press, Seattle, Washington, DC.
- Latas, P. (1987). The use of azaperone in the Spiney dogfish *Squalus acanthus*. *Proc. Int. Assoc. Aquatic Anim. Med.* **18**, 157–165.
- Mark, F.C., Bock, C., et al. (2002). Oxygen-limited thermal tolerance in Antarctic fish investigated by MRI and (31)P-MRS. *Am. J. Physiol. Regul. Integr. Comp. Physiol.* **283**(5), R1254–R1262.
- Official Lists and Indexes of Names and Works in Zoology. (1987). International Commission on Zoological Nomenclature; http://www.iczn.org/Official_Lists_Indexes_pdfs.htm
- Orsi, J., and Short, J.W. (1987). Modifications in electrical anesthesia for salmonids. *Prog. Fish-Culturist* **49**, 144–146.
- Palmer, L.M., and Mensinger, A.F. (2004). Effect of the anesthetic tricaine (MS-222) on nerve activity in the anterior lateral line of the oyster toadfish, *Opsanus tau*. *J. Neurophysiol.* **92**(2), 1034–1041.
- Program, N.T. (1983). Urethane. Report on Carcinogens. US Department of Health and Human Services.
- Rodger, H. (1999). “Fish.” British Small Animal Veterinary Association, Cheltenham.
- Ruuskanen, J.O., Peitsaro, N., et al. (2005). Expression and function of alpha-adrenoceptors in zebrafish: Drug effects, mRNA and receptor distributions. *J. Neurochem.* **94**(6), 1559–1569.
- Singly, J., and Chavin, W. (1975). Serum cortisol in normal goldfish (*Carassius auratus* L.). *Comp. Biochem. Physiol.* **50**(A), 77–82.
- Sladky, K.K., Swanson, C.R., et al. (2001). Comparative efficacy of tricaine methanesulfonate and clove oil for use as anesthetics in red pacu (*Piaractus brachyopomus*). *Am. J. Vet. Res.* **62**(3), 337–342.
- Sneddon, L.U. (2006). Raleigh, (personal communication with L.P. Posner); e-mail.
- Sneddon, L.U., Braithwaite, V.A., et al. (2003). Novel object test: Examining nociception and fear in the rainbow trout. *J. Pain* **4**(8), 431–440.
- Steffey, G. (1996). “Lumb & Jones’ Veterinary Anesthesia.” Lea & Febiger Book, Baltimore, MD.
- Sterritt, D., Elliot, S., et al. (1994). Electrical anesthesia for immobilizing adult coho salmon in freshwater. *North Am. J. Fish. Manag.* **14**, 453–456.
- Stetter, M. (2001). “Fish and Amphibian Anesthesia.” WB Saunders, Philadelphia, PA.
- Stoskopf, M.K. (ed.). (1993). “Fish Medicine.” WB Saunders, Philadelphia, PA.
- Stoelting, R. (1999). “Pharmacology and Physiology in Anesthetic Practice.” Lippincott-Raven, Philadelphia, PA.
- Thorsteinsson, V. (2002). Tagging methods for stock assessment and research in fisheries. Marine Research Institute, Reykjavik, Iceland, pp 108–111.
- Thurmon, J. (1996). “Lumb & Jones’ Veterinary Anesthesia.” Lea & Febiger Book, Baltimore, MD.
- Valverde, A., Doherty, T.J., et al. (2004). Effect of lidocaine on the minimum alveolar concentration of isoflurane in dogs. *Vet. Anaesth. Analg.* **31**(4), 264–271.
- Visser, E., and Schug, S.A. (2006). The role of ketamine in pain management. *Biomed. Pharmacother.* **60**(7), 341–348.
- Williams, T.D., Rollins, M., et al. (2004). Intramuscular anesthesia of bonito and Pacific mackerel with ketamine and medetomidine and reversal of anesthesia with atipamezole. *J. Am. Vet. Med. Assoc.* **225**(3), 417–421.
- Yanar, M., and Kumlu, M. (2000). The anesthetic effect of quinaldine sulphate and or diazepam on sea bass juveniles. *Turk. J. Vet. Anim. Sci.* **25**, 185–189.

Anesthesia and Analgesia of Invertebrates

Cornelia Gunkel and Gregory A. Lewbart

I. Introduction	535
II. Anesthesia	536
A. Mollusks	536
B. Annelids	538
C. Arachnida	539
D. Crustaceans	540
E. Insects	541
F. Nematodes	541
G. Echinoderms	542
III. Pain and Analgesia in Invertebrates	542
IV. Euthanasia	542
References	543

I. INTRODUCTION

Some invertebrate species like the octopus, horseshoe crab, and various species of insects have been utilized in research laboratories for decades. Their contribution has led to knowledge about pesticides and heavy metal toxicity, vision and color perception, embryology, and a long list of diseases including multiple sclerosis and Parkinson's disease.

Invertebrates are playing an ever-increasing and important role in research. The elevated awareness and influence of animal welfare and the attempts and efforts of "refinement, reduction, and replacement" of vertebrate species in research and teaching has had an impact on the invertebrate animal model. The public perception that invertebrates are more acceptable than vertebrates in research settings is mainly due to the belief that

invertebrates do not feel pain; thus, the use of invertebrates serves as an "alternative" when proposals are reviewed by the Institutional Animal Care and Use Committee (IACUC). Furthermore, use of invertebrate species makes the process of IACUC oversight easier, because there are no animal welfare regulations in the United States on invertebrate use. The Animal Welfare Act and Public Health Service (PHS) policy do not cover invertebrates, although accreditation by Association for the Assessment and Accreditation of Laboratory Animal Care International (AAALAC) may require IACUC oversight for invertebrates housed in a central facility. The U.S. Department of Agriculture has an "Information Resource on the Care and Use of Invertebrates" (AWIC Resource Series No. 8, 2000), which has an extensive number of references for invertebrates in research.

The controversial discussion about animal welfare and pain recognition in invertebrates is ongoing; most changes have been initiated from the U.K. and other European countries (Cooper, 2006). It is hoped that the increased veterinary interest in invertebrate medicine will result in more research, leading to more appropriate care for invertebrate species in clinical and research settings and, perhaps, animal welfare regulations. The *UFAW Handbook on the Care and Management of Laboratory Animals* has in its 7th edition (volume 2) a section on advanced invertebrates with references (Poole, 1999). Several reviews, references, and recommendations have recently been published on behaviors and husbandry of different invertebrate species (Anderson and Wood, 2001; Smith and Berkson, 2005; Wood and Anderson, 2004). This may reflect an increased interest in animal welfare for invertebrates and may lead to a change in perception about these animals and their needs.

This chapter reviews common anesthetic techniques for invertebrates with a focus on those species that are frequently seen in laboratory facilities.

II. ANESTHESIA

A. Mollusks

There are about 100,000 described species in this diverse and extensive phylum, with members that occupy terrestrial, freshwater, and marine environments. A number of references (e.g., Lewbart, 2006; Ruppert et al., 2004) provide more information and background on molluscan natural history, anatomy, and physiology. Three major and economically important groups of mollusks (gastropods, cephalopods, and bivalves) are presented here.

1. *Gastropods*

The gastropods are a large recognizable group that includes the abalone, conchs, limpets, nudibranchs, sea hares, slugs, and snails, among others. Most are aquatic and have an external calcium carbonate shell, muscular foot for locomotion, gills for respiration, and a well-developed head with eyes and paired tentacles. Gastropods move slowly and are generally easy to restrain manually.

Snails can be anesthetized using 5% ethanol or menthol (Flores et al., 1983) and with inhalant agents such as isoflurane (Girdlestone et al., 1989). A commercial 10% Listerine[®] solution (ethanol 21.9%, menthol 0.042%) in normal *Lymnaea* saline has been used to anesthetize snails in research settings (Woodall et al., 2003). Sodium pentobarbital at 400 mg/L in water has been reported with a very slow 8-hour onset, but good effects and a low mortality rate (Martins-Sousa et al., 2001). A combination of sodium pentobarbitone and tricaine

methanesulfonate (MS-222) has been described as useful for relaxation and anesthetizing various species of snails (Joose and Lever, 1959; Mutani, 1982), with an onset time of 60 minutes and a long-lasting effect.

Anesthesia via isoflurane for terrestrial snails requires an anesthetic chamber with the ability for fresh anesthetic agent inflow and waste gas scavenging (Girdlestone et al., 1989). The minimum alveolar concentration (MAC) of isoflurane in the pond snail is 1.09 (Girdlestone et al., 1989). Induction is fast (<10 minutes), but there may be an excitatory period. A disadvantage is the need to take the animal out of the chamber for a procedure, resulting in fluctuation of anesthetic depth and increased work area pollution. In addition, the depth of anesthesia may not be adequate for some surgical procedures. A successfully anesthetized snail lacks body and tentacle withdrawal following gentle stimulation. Persistent tentacle withdrawal reflex while under inhalant anesthesia may suggest an insufficient surgical depth (Girdlestone et al., 1989). Ketamine and propofol do not induce anesthesia, and might even have an excitatory effect (Woodall and McCrohan, 2000). Ketamine in combination with xylazine may have toxic effects (Martins-Sousa et al., 2001).

Sea snails are commonly anesthetized with intracoelomic administration of magnesium sulfate or MgCl₂. Induction can be fast (2–5 minutes) and smooth, with good muscle relaxation. Halothane and MS-222 appear to be ineffective (administered as immersion or intracoelomic) anesthetic agents in sea snails (Clark et al., 1996).

Abalones are commercially farmed, and this practice frequently requires physical examination and sizing, pear-seeding, and removal of the animals from tanks for harvesting and maintenance (White et al., 1996). Research involving abalone is focused on furthering knowledge of its natural history. Removing abalones from the substratum is often only possible with mechanical assistance due to their attachment ability. Forced removal may result in injury leading to morbidity or even mortality. Therefore, an anesthetic or relaxing agent may help to avoid stress and mechanical injuries related to dislodging. Protocols used for this purpose and in abalone research include 2-phenoxyethanol (1–2 ml/L), benzocaine (100 mg/L), ethanol (3%), magnesium sulfate (20–240 g/L), and sodium pentobarbital (1 ml/L) (Aquilina and Roberts, 2000; Edwards et al., 2000). White et al. (1996) found magnesium sulfate to be successful as an immersion anesthetic (4–22 g/100 ml) with higher concentrations necessary for larger animals. Induction time was fast (5–8 minutes) and recovery uneventful (requiring 3–35 minutes, depending on the dose and anesthesia time). Phenoxyethanol administered at 0.5–3.0 ml/L results in a fast induction period (1–3 minutes) and good recovery time (5–20 minutes) (White et al., 1996). Nembutal (sodium pentobarbital, 1 ml/L) produces good muscle relaxation, with an induction time of 15 minutes and complete recovery (Aquilina and Roberts, 2000). Clove oil (0.5–1.5 ml/L) and propylene phenoxytol (2.5 ml/L) are not recommended, because both agents can cause high mortalities

(Aquilina and Roberts, 2000; Edwards et al., 2000). Benzocaine (0.1 g/L) and MS-222 (1 g/L) are ineffective as muscle relaxants (Aquilina and Roberts, 2000). Both MS-222 and propylene phenoxetyl cause excitation upon induction, resulting in copious mucus production and loss of pigmentation (Aquilina and Roberts, 2000).

Recovery from any anesthetic protocol includes thorough washing of the animal(s) and exposure to fresh-flowing seawater at their optimal temperature (usually 18°C) until muscle strength returns.

2. Cephalopods

This group of predatory and highly specialized mollusks include familiar forms such as the chambered nautilus, cuttlefish, octopuses, and squids. Some cephalopod species have been extensively studied. Most cephalopods are pelagic and have the ability for fast locomotion. They have well-developed nervous systems including excellent vision and tactile ability, closed circulatory systems, and relatively high metabolic rates. Most species have an internal skeleton, with the exception of the octopuses (no skeleton) and chambered nautilus (external shell).

When stressed, which occurs readily, cephalopods often elicit a defensive response termed “inking.” Cephalopods can be difficult to handle without sedation. Buckets, plastic nets, or other objects may be used to capture, restrain, or contain cephalopods, but handlers should bear in mind that these species are “specialized escape artists” (Wood and Anderson, 2004).

Cephalopods should be anesthetized in their own environmental seawater to maintain the appropriate mineral and electrolyte balance. The two most commonly used anesthetic agents in cephalopods are MgCl₂ and ethanol. A cuttlefish was successfully anesthetized for surgery with 1.5–3% ethanol (15–30 ml/L) diluted in seawater (Harms et al., 2006). Induction may be rapid (1 minute), especially at higher doses, and dilution to a lower concentration (10–15 ml/L) to decrease the risk of overdosing should be considered. During induction with lower concentrations of ethanol, occasional transient excitement has been noted (Harms et al., 2006). If the procedure cannot be performed with the animal submerged, anesthesia can be facilitated with a recirculating anesthesia system (Lewbart and Harms, 1999), in which the anesthetic concentration of water may be adjusted to the depth of anesthesia desired.

When MgCl₂ is used as an anesthetic agent, a 7.5% stock solution is prepared with distilled water (Gore et al., 2005; Scimeca and Forsythe, 1999). This stock solution is mixed with a known volume of seawater to prepare an anesthetic concentration suitable for induction. A final concentration of 6.8 g/L (100 ml of the stock solution mixed with 1 L of seawater) was reported to have an induction time of 6–12 minutes without side effects (Gore et al., 2005). Due to the size of most mature cuttlefish, a total water volume of 5–10 L is commonly required. Induction is normally smooth and without a period of excitation. Decreases in

concentration via dilution may be necessary to adjust anesthetic depth.

Octopuses are anesthetized similarly to cuttlefish. Two commonly employed anesthetics are ethanol and MgCl₂. Andrews and Tansey (1981) reported that ethanol (2% v/v in seawater) can produce excitement during the short induction time (increased respiratory rate, escape attempts, and inking). Induction time was 4 minutes, and time to full recovery was 2.5 minutes. Ethanol (2%) is apparently not effective in cold-water species (below 15°C) (Gleadall, 2006).

MgCl₂ is the preferred anesthetic for use in cephalopods. It is employed by preparing an isotonic solution of 7.5% MgCl₂ 6H₂O (in distilled water) mixed with an equal volume of seawater (Messenger et al., 1985; Scimeca and Forsythe, 1999). Induction time is normally between 1.5 and 13 minutes with a short period of hyperventilation followed by a gradual increase in arm flaccidity and loss of righting reflexes. It is considered to be a very smooth process by some investigators (Culloty and Mulcahy, 1992; Messenger et al., 1985). Respiration will decrease and eventually cease, if the anesthetic concentration is not properly diluted. The gills should be intermittently or constantly perfused with anesthetic seawater. The time of recovery from MgCl₂ is usually fairly fast (1–10 minute), but may depend on procedure length and type (up to 20 minutes after longer procedures).

There remains a question whether MgCl₂ produces adequate sedation and analgesia via the blocking of nerve transmission and neurotransmitter release, or acts only as a neuromuscular blocking agent. Differences in vertebrate versus invertebrate anatomy/physiology, as well as routes of administration, may play a role, but the issue remains unresolved (Clark et al., 1996), and further research is needed to evaluate MgCl₂ as an anesthetic. An analgesic, such as ketoprofen or butorphanol (extrapolating dosing regimens from the lower vertebrate literature), should be added to the protocol for any painful procedure to make best effort at adequate patient care, even though we do not currently have pharmacokinetic or efficacy data for analgesic agents in cephalopods.

The use of urethane has been well documented (Andrews and Tansey, 1981; Gleadall, 1991; Messenger et al., 1985) and was routinely used in the 1970s and 1980s. Despite good anesthetic results, the traumatic effects on the animals were severe (excitement during the induction phase); furthermore, its carcinogenic, irritant, and hemolytic side effects preclude its use. CO₂, chloroform, and chloral hydrate are unsuitable anesthetic agents in cephalopods due to high mortality (Garcia-Franco, 1992; Gleadall, 1991).

Hypothermia, despite its popularity and common presence in the literature, is not an adequate anesthetic and should not be used in cephalopods due to a lack of analgesic and muscle relaxing properties. Mortalities and distress have been reported (Bower et al., 1999), and may be due to underestimation of cardiovascular and respiratory compromise during hypothermia, as well as during the warming phase.

Recovering cephalopods must be placed into anesthesia-free seawater. For optimal results, the recovery water should be circulated and aerated in an appropriately sized container. Gentle and slow mantle massage can be used if spontaneous respiration is not present. As the animal awakens, the extended and flaccid tentacles will retract in response to light pinching. Cephalopod resuscitation includes squeezing and relaxation of the whole mantle/body to facilitate anesthesia-free water circulation over the gills and hemolymph through the body (Harms et al., 2006).

Respiratory rate and pattern are frequently used to monitor anesthetized cephalopods, but depth of anesthesia is difficult to assess. Adequate anesthesia is likely when there is no detectable response to tactile and surgical stimuli, e.g., withdrawal of appendices, contraction of the skin around the eye in response to pressure on the globe, and withdrawal of the animal in response to a skin pinch over the eye. Further indicators of anesthetic depth are the inability to regain normal posture after disturbance, loss of normal posture, and flaccidity of the arms (Andrews and Tansey, 1981). Cessation of respiration may indicate a critically deep level of anesthesia, because respiration is normally spontaneous.

Normal resting values for 100–800 g *Octopus vulgaris* is 26–30 breaths/min (Andrews and Tansey, 1981). A Doppler probe placed on the dorsal area (above the aorta) or behind the gills (above either branchial heart) can be used to monitor heart rate and blood flow. A pulse oximeter may be used for heart rate but will likely give false readings due to the presence of hemocyanin instead of hemoglobin. The pallial organs can be observed in transparent species (esp. with $MgCl_2$).

3. Bivalves

This economically important and very large group of highly evolved aquatic mollusks includes the clams, mussels, oysters, and scallops. Bivalves lack a well-developed head, are nonvisual (scallops are an exception), utilize a muscular and sometimes large foot for locomotion, and are filter feeders utilizing the gills for food transport. Bivalve research is focused primarily on fisheries and ecology projects. Bivalves are easily and safely handled and restrained. Most will tightly close their calcareous valves with strong adductor muscles when handled or disturbed, requiring sedation or physical manipulation (prying) to access the soft parts.

Propylene phenoxetol (1% solution) is used to anesthetize oysters with a 1–3 ml/L dosing range. Higher doses produce rapid and relatively deep anesthesia (Mills et al., 1997) and may require dilution throughout a procedure to decrease recovery time (Norton et al., 1996). Concentrations of 1–2 ml/L are generally safe and effective. Oysters should be placed hinge down in the anesthetic solution and leaned against the aerated container wall to facilitate monitoring. The induction time is reported between 6 and 15 minutes. Adequate anesthesia is reached when the oyster shows no response to handling and gapes wide enough to part the gill curtain (Mills et al., 1997),

and there is no contraction of soft tissues following stimulation (Norton et al., 1996).

Minimal handling before placing oysters into the anesthesia container will improve the anesthetic effects and opening. Recovery time is generally short (less than 30 minutes), although a number of variables (anesthetic concentration, length of procedure, and temperature) can affect recovery (Norton et al., 1996). Recovery tanks should be well aerated.

$MgCl_2$ has variable effects on oysters. Some workers describe little effect of $MgCl_2$ in pearl oysters (Mills et al., 1997; Norton et al., 1996) because of long induction times (1–2 hours). Cul-loty and Mulcahy (1992) report good anesthetic effects with long induction and recovery times (90 minutes) at 3.5%. The efficacy of $MgCl_2$ depends on the species and the concentration. Chloral hydrate and MS-222 are not effective in oysters (slow induction and recovery) and are associated with mortality (some may be related to the low pH of unbuffered MS-222) (Norton et al., 1996).

Anesthesia of a scallop may be required for adductor muscle relaxation. Depth of anesthesia/relaxation is considered adequate when handling/stimulating the mantle tissue fails to result in valve closure. Recovery is often defined as the ability for valve closure in response to handling (Heasman et al., 1995). $MgCl_2$ is the anesthetic compound of choice in scallops due to its consistent and rapid induction and recovery. The agent is predissolved in seawater and then added to an aerated induction container for a concentration of 30–50 g/L. Induction times at these concentrations are in the range of 2–6 minutes. The recovery time in scallops anesthetized with $MgCl_2$ seems to be consistently short (10 minutes) regardless of the concentration or water temperature (Heasman et al., 1995).

Chloral hydrate has variable effects on scallops with significant changes in induction and recovery at different concentrations and water temperatures (Heasman et al., 1995). At 24°C, a concentration of 4 g/L produces anesthesia in about 10–25 minutes. Lower temperatures will markedly slow induction. Higher concentrations will shorten induction time but can result in high mortality. At a concentration of 4 g/L, the recovery time is between 20 and 30 minutes but can vary widely depending on temperature. Aerated recovery tanks and continuously flowing seawater will facilitate recovery.

Other drugs have been examined for anesthetizing scallops with little success. Benzocaine causes an initial hyperactivity, ethanol does not have any effect, magnesium sulphate leads to high mortality, metomidate results in shell closure, and MS-222 causes hyperextension and hyperactivity (Heasman et al., 1995).

Propylene phenoxetol has been used to anesthetize giant clams (*Tridacna* sp.) (Mills et al., 1997).

B. Annelids

The annelids are a large and diverse group of segmented worm-like animals that are divided into three main classes:

Polychaetes, Oligochaetes, and Hirudineans. All are characterized by regular segmentation of the coelomic cavity as well as the circulatory, excretory, and nervous systems. This segmentation probably evolved as a means of burrowing via peristaltic contractions (Ruppert and Barnes, 1994). A cuticle covers the animal, and segmented setae occur in nearly all annelids. A more or less straight gut tube lies between the anterior mouth and the posterior anus (Ruppert and Barnes, 1994).

1. *Polychaetes*

Like many marine invertebrates, polychaetes can be sedated with $MgCl_2$ in water. While it is possible, if not likely, that some species are more sensitive than others, a concentration of 7.5–8.0% seems to work well for relaxation (Lewbart and Riser, 1996; Müller et al., 2003).

2. *Oligochaetes*

Cooper and Roch (1986) anesthetized *Lumbricus terrestris* with a 5% alcohol (presumably ethanol) solution for a period of 1 hour prior to tissue grafting experiments. In some earlier experiments, Cooper (1968) used 5% ethanol in Rushton's Ringers solution until the worms (*L. terrestris* and *Eisenia foetida*) were immobilized. Marks and Cooper (1977) utilized 5% ethanol at a temperature of 23°C for *L. terrestris* and *E. foetida*.

3. *Hirudineans*

There is little in the literature on leech anesthesia. One report describes the use of saturated mephenesin (3-*o*-toloxyl-1,2-propanediol) to anesthetize leeches for grafting research (Tettamanti et al., 2003).

C. Arachnida

1. *Spiders and Scorpions*

Physical restraint is commonly used to transport spiders, but it is advisable to wear latex gloves, since some tarantula species are capable of shedding urticating hairs that can be very irritating, especially to people allergic to these structures. Direct handling of scorpions should be kept to a minimum for the safety of both the animal and the handler. Clear plastic containers, and in some cases utensils like long forceps or tongs, can be used to move an animal from one place to another (Frye, 2006). The primary drawbacks of manual restraint for spiders or scorpions are injury to the animal and potential envenomation of the handler. Precautions should be in place to minimize risk of these animals leaping or falling to the ground or other firm substrate.

Inhalant anesthetic agents are most commonly and successfully used with spiders and scorpions. Many agents (desflurane, halothane, isoflurane, and sevoflurane) can be used, depending on cost and availability, although isoflurane and sevoflurane

are most commonly used for spiders and scorpions (Cooper, 2001; Melidone and Mayer, 2005; Pizzi, 2006). Halothane (limited availability) is undesirable for invertebrate anesthesia due to the potential for toxicity to personnel during gas delivery. Several unique induction chambers have been described (Cooper, 2001; Melidone and Mayer, 2005; Pizzi, 2006) and used successfully for delivering inhalant anesthesia to spiders and scorpions. Ideally, these devices are commercially available, invertebrate-specific induction chambers with appropriate fresh gas inflow and scavenging outflow. Regular small mammal induction chambers or simple self-made clear plastic containers may also be employed.

The animal is placed into the chamber, and the chamber is filled with the anesthetic gas (about 3–5% for isoflurane; 4–6% for sevoflurane). To decrease the filling time in larger chambers, the oxygen flow rate is high at the beginning (1.0–3.0 L/min), but can be decreased if there are no significant leaks in the system (0.3–1.0 L/min). Oxygen flow lower than 0.2 L/min decreases the accuracy of the vaporizer and may reduce the amount of anesthetic agent in the chamber due to uptake by the animal. The amount of CO_2 accumulation in the chamber may also increase using low fresh gas flows. An appropriate scavenging system is required to decrease pollution. With increasing depth of anesthesia, the vaporizer can be adjusted to decrease anesthetic concentration. The MAC of anesthetic agents in spiders and scorpions has not been reported.

The advantages of the chamber technique are convenience, low cost, and safety to the patient. The disadvantage associated with this type of system is that the animal can only be temporarily sedated or anesthetized. For hands-on physical examination or surgery, the animal is removed from the chamber, limiting the time for any procedure before the animal recovers. This protocol may require repeated inductions, increasing the exposure of the clinician and staff to the anesthetic gas. A surgery chamber has been developed (Melidone and Mayer, 2005) that allows the clinician to perform surgery or other manipulations without removing the animal from the chamber.

Another interesting technique is to induce the spider in an anesthetic chamber and then place its abdomen (with the associated book lungs/tracheae—the arachnid respiratory organs) into a smaller chamber “sealed” with a latex glove. This technique is advantageous when a procedure must be performed on the cephalothorax or limbs (Dombrowski, 2006). If plastic containers without an inflow and outflow system are used, a cotton wool swab soaked with an inhalant agent is placed into the box. The animal should be placed in a separate smaller container with appropriately sized pores. The smaller container holding the spider or scorpion is placed into the larger box allowing the inhalant to diffuse into the box, while ensuring that no direct animal contact with the inhalant-soaked material occurs. This method is not ideal because of the anesthetic exposure risk to personnel and minimal control of the amount of anesthetic delivered. Vapor pressures of sevoflurane (157 mmHg) and isoflurane (238 mmHg) differ significantly. Isoflurane can reach a

maximum concentration of 32% in room air (vapor pressure divided by atmospheric pressure times 100), and sevoflurane, being slightly less volatile, produces a maximum concentration of about 20%. Nevertheless, both inhalants can pollute room air, so this method requires close monitoring.

Other chemical agents like CO₂N₂, as well as hypothermia, have been used to immobilize spiders (Madsen and Vollrath, 2000; Pizzi, 2006). No reports about the amount of N₂ used or the quality of N₂ anesthesia could be located. CO₂ is administered as a gas in a chamber, often with 98% saturation. Dilution with air or oxygen is hard to achieve, resulting in an increased risk of mortality (Pizzi, 2006). Side effects of CO₂ anesthesia are well recognized in vertebrates and should be considered when this agent is used for invertebrate species. Hypothermia is not an anesthetic and does not provide analgesia. Hypothermia is considered to be painful and should not be used as an anesthetic, especially for surgical procedures.

Depth of anesthesia can be monitored by observing the spider or scorpion for righting reflexes and leg movements. Induction may take 10–15 minutes with several attempts of the animal to move and reposition itself until full immobilization has occurred. During the procedure, leg movements in response to stimuli are a clear sign of insufficient anesthetic depth. An increase in heart and respiratory rate may be observed, but is often unrecognized. A deep level of anesthesia is difficult to evaluate; slow respiratory rate and low heart rates are often the only way to assess a patient for excessive depth of anesthesia. An analgesic administered for painful stimuli may make it easier for the clinician to maintain a consistent level of anesthesia. The respiratory rate is observed at either cranial lateral side of the animal. The heart rate can often only be monitored in larger spiders or scorpions. The spider heart lies beneath the dorsal body surface. With a Doppler (pin point-crystal head) placed over the cardiac region, a rate can be obtained. Normal heart rates are 30–70 beats/min in large spiders and up to 200 beats/min in smaller species.

After turning off the inhalant agent and maintaining the animal on fresh oxygen flow or room air, the recovery from anesthesia is gradual and can take between 3 and 20 minutes depending on ambient room temperature and the depth of anesthesia during the procedure (Walls et al., 2002). Slow appendage movements and righting attempts occur and increase over time. When fully awake, the animal should be returned to its enclosure and maintained at its preferred temperature and humidity. Feeding should be withheld for 48 hours after anesthesia (Pizzi, 2006).

2. Horseshoe Crabs

The American horseshoe crab (*Limulus polyphemus*) is the most common of the four species and frequently used as a laboratory animal model to study its eye and nervous system, and to represent marine invertebrate embryology (Smith, 2006; Smith and Berkson, 2005). The blue blood of the horseshoe crab, owing to the presence of the pharmaceutical compound Limulus

amebocyte lysate (LAL), is a topic of extensive research. Horseshoe crabs can easily be handled and restrained, although strong locomotion and righting reflexes can make examinations difficult (Smith and Berkson, 2005). The holder is cautioned not to pinch their fingers between the lateral edge of the opisthosoma and the genal angle of the prosoma (Smith, 2006).

The tubular heart of the horseshoe crab is located dorsally over the entire length of the body (Spotswood and Smith, 2007). Electrocardiogram (ECG) patches placed on the cephalothorax will detect a heart rate. Normal awake heart rates in horseshoe crabs are 30 beats/min depending on temperature (23°C) (Redmond et al., 1982). Injections of anesthetic agents can be given through the arthrodistal membrane into the cardiac sinus (Spotswood and Smith, 2007), but no studies evaluating different anesthetic agents could be found in the literature. The blood/hemolymph collection site has been extensively reported (Smith, 2006; Smith and Berkson, 2005) and is easily accessed.

D. Crustaceans

The crustaceans are a diverse, large and well-established group of arthropods that are all aquatic at some stage of their life history. The order Decapoda contains many of the most conspicuous and economically important crustaceans, including the crabs, crayfish, hermit crabs, lobsters, and shrimp. Research in this order involves genetics, morphology, reproduction, ecology, behavior, and fisheries science. Most specimens can be restrained with gloved hands or, in some cases, with the help of nets or tongs. Since some crustaceans, such as lobsters and large crabs, can inflict injury to handlers, extra care should be taken when working with these animals (Noga et al., 2006).

Crustaceans have been anesthetized with a variety of agents. Depending on the animal's size and procedure protocol, intramuscular injections of lidocaine, ketamine, or xylazine, immersion MS-222, and isobutyl alcohol have been suggested (Brown et al., 1996; Ferraro and Pressacco, 1996; Gardner, 1997; Oswald, 1977). MS-222 is generally accepted as noneffective in producing anesthesia in decapods (Gardner, 1997; Oswald, 1977) as only very high doses show some effect (>1 g/L) with very long induction time (Brown et al., 1996; Gardner, 1997).

In *crayfish*, lidocaine (0.4–1 mg/g) injected intramuscularly into the tail lasts for about 5–30 minutes, depending on the dose, with an average induction time of 90 seconds (Brown et al., 1996).

Ketamine (0.025–0.1 mg/kg, IV) has been used in the Australian *giant crab* (*Pseudocarcinus gigas*) (Gardner, 1997) and in *crayfish* (40–90 mcg/g) (Brown et al., 1996) with variable results. Ketamine administered intramuscularly to *crayfish* will provide consistent anesthesia (induction time: 1 minute) for over 10 minutes (40 mcg/g) to almost 2 hours (>90 mcg/g) without excitatory effects during induction or recovery (Brown et al., 1996). When ketamine was given intravascularly to the *giant crab* (*P. gigas*), induction time was fast (15–45 seconds), but

there was a short period of excitement (Gardner, 1997). The duration of dose-dependent anesthesia was between 8 and 40 minutes.

When used at doses between 16 and 22 mg/kg, IV, xylazine has shown good anesthetic effects in adult giant crabs (Gardner, 1997) or at 70 mg/kg, IV in common shore crabs (*Carcinus maenas*) (Oswald, 1977). Induction is smooth and fairly fast (3–5 minutes) with immobilization lasting 25–45 minutes (dose dependent). With high doses (70 mg/kg), side effects including bradycardia, dysrhythmias, and extrasystoles have been reported (Oswald, 1977).

Using a small needle (25 gauge), intravascular injections can be given in adult giant crabs through the coxal arthropodial membrane of a cheliped (Gardner, 1997; Oswald, 1977). It is presumed that drugs like ketamine and xylazine can be administered intramuscularly, though this may lead to a slightly longer induction time. No data has been published on combining these drugs or the use of other anesthetic agents like etomidate, metomidate, or propofol.

Procaine (25 mg/kg, IV) has been used in crabs, and provides good anesthesia with a very short induction time (20–30 seconds). This included a 10-second excitatory period that led to tonic contraction before paralysis. The duration was very long (2–3 hours) with slow recoveries (Oswald, 1977). This protocol may be appropriate for long-term experimental anesthesia.

When an IV or IM injection is impractical (e.g., for smaller crabs), clove oil can be used as an immersion anesthetic and, at a dose of >0.125 ml/L, has shown a 16-minute onset of anesthesia and a long recovery phase (2.5 hours). Once the animal is anesthetized, a reduction of anesthetic concentration is necessary, since clove oil at 0.125 ml/L over a longer duration can be used for euthanasia of crustaceans (Gardner, 1997).

Crustacean heart rates can be determined by applying ECG pads with ample gel on the shell above the heart. The normal heart rate for shore crabs is 30–70 beats/min and depends on pH and temperature (Styrishave et al., 2003), while lobsters have rates between 5 and 20 beats/min with a circadian influence (elevated at night) (Aguzzi et al., 2004). Anesthetic depth is evaluated by the relaxation of the body and the animal's ability to withdraw extremities. The anesthetized crustacean will display a very slow antennae withdrawal response to stimuli.

E. Insects

This group of invertebrates has nearly a million described species and is famous for its diversity. Insects are arthropods with three major body segments (head, thorax, and abdomen) and three pairs of legs, which leads to the term Hexapoda, as this group is named by some taxonomists. Well-developed mouthparts, sensory antennae, keen eyesight, and wings are present in most species. The open circulation system contains hemolymph, and gas exchange function is possible through

spiracles that open into a system of tracheae. Insects have been used for years in a variety of research. *Drosophila* may be the best known representative for genetic research studies, but other species are important contributors of information on pathogen–vector interaction in various diseases, metamorphosis and anatomy/physiology (facet eye, senses), ecology and agriculture, pharmaceutical control, etc.

Most insects, depending on size and species, can be manually handled and restrained without risk to the animal or handler. For some species, protective measures are necessary, and gloves or utensils are recommended.

Anesthesia has been used for years in entomological research, but insects are also a big part of answering questions regarding the mechanism of action of anesthetic agents. CO₂ and inhalant agents as well as hypothermia are commonly used. CO₂ is considered the most popular agent, despite the fact that various side effects likely occur, including convulsion and excitation at induction, and that the mortality rate is high (Nicolas and Sillans, 1989; Valles and Koehler, 1994). Its use and analgesic properties remain controversial. Recently, the use of volatile anesthetic agents such as isoflurane or sevoflurane have been advocated and is considered a more progressive approach. This technique requires a chamber apparatus for appropriate delivery and scavenging of the inhalant agent (Walcourt and Ide, 1998). It is still difficult to assess the depth of anesthesia in insects. Although total immobility and absence of righting reflex are the most reliable indicators for assessment (Cooper, 2006), these might not address if the animal is too deeply anesthetized. Hypothermia is used for temporary immobilization of insects to be able to perform diagnostic evaluations, but for surgical or otherwise stressful/painful procedures, its use is discouraged (Cooper, 2006).

F. Nematodes

Nematodes are one of the largest groups of invertebrates with around 500,000 known species (Bodri, 2006). Numerous species have been extensively used in research for plant-parasite effects, diseases, and genetics. *Caenorhabditis elegans* is probably the most researched nematode as it is commonly used as an animal model, due to its size and nervous system. Research on *C. elegans* has led to scientific information about meiosis, nicotine dependence, volatile anesthetics, and genetics. Due to its popularity, most anesthetic agents reported for nematodes are based on the use in *C. elegans*, and their anesthetic effects on the animal is well described (Bodri, 2006).

C. elegans has been anesthetized with CO₂ (Bodri, 2006), 4.5% ethanol (Jones and Candido, 1999), propylene phenoxetol (Nelson, 1984), and inhalants (Morgan and Cascorbi, 1985; Morgan et al., 1990). ED₅₀ values for the different inhalant agents are established in Morgan's studies and the anesthetic chamber for these species is described (Bodri, 2006; Morgan and Cascorbi, 1985).

G. Echinoderms

Familiar members of this entirely marine phylum include the brittle stars, feather stars, sand dollars, sea biscuits, sea cucumbers, sea lilies, sea stars, and sea urchins. Most species can be handled safely and effectively without anesthesia or sedation. Echinoderms tend to be slow moving and quite hardy (one exception being the brittle stars). Some sea urchin species can inflict a painful “sting” with movable, sharp spines. Gloves and nets can aid in the safe handling of many species.

If echinoderms require anesthesia/immobilization, $MgCl_2$ or MS-222 is commonly used (Harms, 2006). Sea stars are anesthetized with their aquarium/tank water (i.e., water of the aquarium is placed into the “anesthesia bucket”) to maintain consistent temperature and water content (including pH, salinity, etc.). To a known amount of clean seawater, $MgCl_2$ is added to produce a 7.5–8% solution. A 1:1 mixture has been reported (McCurley and Kier, 1995) and may be necessary for induction, but adjustments over time during anesthesia may be required (gradually administering more seawater). A concentrated form of MS-222 (1–10 g/L in seawater) can also be used (Hendler et al., 1995; O’Neill, 1994). Other reported anesthetic agents are menthol (2.5–5% in sterile seawater) (Costello and Henley, 1971) and propylene phenoxetol (2 ml/L in seawater) (Hendler et al., 1995; Van den Spiegel and Jangoux, 1987). Sea cucumbers may respond better to propylene phenoxetol than to $MgCl_2$.

III. PAIN AND ANALGESIA IN INVERTEBRATES

More research needs to and likely will occur to answer questions about pain perception by invertebrates. To date the concept that invertebrates “feel” pain is a topic of debate (Sherwin, 2001). One component of this debate is the differentiation between nociception and pain. Nociception describes the neurophysiologic components leading to the sensation of pain, but excludes the central perception of pain. Nociception can lead to pathophysiological changes to various systems in the body (cardiovascular, respiratory, endocrine, etc). Pain is defined as the “subjective sensation or emotional experience” resulting from nociceptive input, an experience created in the cerebral cortex. Invertebrates do not possess a well-described cortex as part of their central nervous system, or a similar structure, although a nociceptive response is present (Tobin and Bargmann, 2004). Nociceptor cells have been identified in invertebrates (Nicholls and Baylor, 1968), and opioid systems have a functional role in invertebrate nociception (Fiorito, 1986; Kavaliers, 1988; Kavaliers et al., 1983; Saksida, 1993; Smith, 1991; Thomas et al., 1997).

No definitive answer exists as to whether invertebrates perceive pain and suffer emotional stress from it. Invertebrates respond to mechanical, chemical, and electrical stimuli by withdrawal and escape behaviors similar to vertebrates. This

response is decreased or slowed when an analgesic is used (Kavalier and Hirst, 1983), but it is not clear if this is due to a sedative effect or an analgesic effect of the drug. Until current pain research answers these questions, more awareness is needed of the animal welfare implications of performing potentially painful procedures. Invertebrate species should be given the benefit of doubt and receive an analgesic when subjected to a painful procedure. The amount of stress and pain to an animal can be reduced by appropriate choices of anesthetic agents (agents with analgesic properties) and the humane handling of the animal. Hypothermia and CO_2 , for example, do not possess analgesic properties and may even show hyperalgesic characteristics. Although inhalant agents do not possess true analgesic properties, they do render vertebrate species insensible to painful stimuli when administered at sufficient doses. However, this insensibility lasts only for the duration the animal is anesthetized; if the procedure is expected to be associated with significant postoperative pain, the administration of an analgesic would be advisable.

The use of analgesic agents in invertebrate species is limited, because few reports can be found in the literature documenting drug administration and dosing, especially in very small species; there is also little information evaluating the effects and impact of different analgesics on the patient, the anesthesia, and the recovery. Local anesthetics are an efficient way to block the nociceptive pathway and, therefore, decrease the pain stimulus, but dosing might be a challenge. Opioids are another good way to provide analgesia. Until the literature expands with research data on drugs, dosages, and species to be treated, the clinician is advised to judiciously extrapolate dosing information from what has been published on the “lower” vertebrates (fishes, amphibians, and reptiles). We realize this is a broad statement, sure to make some veterinarians uncomfortable, but it is a starting point and probably the best option we have at this time. The assessment of pain or discomfort in invertebrates is another difficult task, despite the fact that some avoidance behavior has been described (Mather, 2001; Tobin and Bargmann, 2004). The effect of analgesia is even harder to evaluate.

IV. EUTHANASIA

Invertebrates are not specifically regulated in the United States, and not addressed by the AVMA Panel on Euthanasia (2000), which leaves the researcher with little guidance for euthanasia of invertebrate laboratory animals. Some suggestions for improving animal welfare in invertebrates can be found in the literature coming from Europe and Australia (Cooper, 2006; Reilly, 2001), but more research and regulations are necessary to assure ethically acceptable methods for invertebrate euthanasia (Murray, 2006). The *UFAW Handbook on the Care and Management of Laboratory Animals* (Poole, 1999) provides details of euthanasia methods for “advanced”

invertebrates (cephalopods and crustaceans), and the AAZV recently published the extensive *Guidelines for Euthanasia of Non-domestic Animals* (AAZV, 2006) that includes a section on invertebrate species. Despite the debatable ability of invertebrates to feel pain, it is well recognized that different species of invertebrates show various types of stress responses and reactions to noxious stimuli. Given that the perception of pain is not fully understood, it is our responsibility to treat every living creature with respect, assure the well-being of these animals, and decrease the stress put on the individual animal in the best possible way (Murray, 2006).

Euthanasia should be performed in an effective, fast, pain-free and stress-free manner. Most commonly used methods for euthanasia are terminal anesthesia followed by physical destruction of the nervous system. The physical destruction of the nervous system/primary ganglia may be added to the chemical method, because death is often difficult to verify in invertebrates (Hackendahl, 2002). It is important to keep in mind that the nervous system varies among invertebrate species, and that decapitation alone may not always be a suitable method (Hackendahl, 2002). Other destructive methods may have to be implemented when doubts remain about the confirmation of death from an anesthetic overdose. Methods like hypothermia, hypoxia, hypercapnia, toxins, etc. alone are unsuitable in some invertebrate species due to their ability to adapt to extreme situations and recover from the above-described insults. These methods also may prolong the euthanasia process, add stress, and should not be considered as ideal from an ethical point of view. More information about ideal species-specific methods of euthanasia is needed due to the large variety of invertebrate species. Some recommendations have been made regarding acceptable or recommended euthanasia in specific invertebrate species. Emphasis is placed on methods that reduce stress for the animal until more is known about the effects of stress and pain on these species. Special consideration and adjustments may be necessary for research that relies on preservation of specific tissues or interference of anesthetic agents with the research purpose.

The horseshoe crab can be euthanized with an injection of 1–2 ml of pentobarbital directly into the cardiac sinus (Smith and Berkson, 2005). Recommendations for cephalopods are an overdose of ethanol or MgCl₂, followed by brain destruction (Lewbart, 2006; Murray, 2006; Reilly, 2001; Scimeca, 2006), and an overdose of MS-222 with subsequent brain destruction is considered acceptable (Reilly, 2001). Recommended euthanasia methods for crustaceans are an overdose of ethanol or clove oil followed by brain destruction (Reilly, 2001). Pizzi describes a 70% ethanol immersion after general anesthesia as an acceptable method for euthanasia in spiders (Pizzi, 2002, 2006).

This chapter, with an emphasis on laboratory animals, is a revised and modified version of a chapter recently published by the same authors entitled “Invertebrates” in the book *Zoo and Wildlife Anesthesia and Immobilization* (ed. Heard et al., 2007).

REFERENCES

- AAZV. (2006). “Guidelines for Euthanasia of Non-domestic Animals.” American Association of Zoo Veterinarians, Yulee, FL.
- Aguzzi, J., Abello, P., and Depledge, M.H. (2004). Endogenous cardiac activity rhythms of continental slope *Nephrops norvegicus* (Decapoda: Nephropidea). *Mar. Fresh Behav. Physiol.* **37**(1), 55–64.
- Anderson, R.C., and Wood, J.B. (2001). Enrichment for Giant Pacific octopuses: Happy as a clam? *J. Appl. Anim. Welf. Sci.* **4**(2), 157–168.
- Andrews, P.L.R., and Tansey, E.M. (1981). The effects of some anesthetic agents in *Octopus vulgaris*. *Comp. Biochem. Physiol.* **70C**, 241–247.
- Aquilina, B., and Roberts, R. (2000). A method for inducing muscle relaxation in the abalone, *Haliotis iris*. *Aquaculture* **190**, 403–408.
- AVMA Panel on Euthanasia. (2000). Report of the AVMA Panel on Euthanasia. *J. Am. Vet. Med. Assoc.* **218**(5), 669–696.
- AWIC Resource Series No. 8 (May 2000). Slightly Revised October 2000, edited by M.D. Kreger, MS.
- Bodri, M.S. (2006). Nematodes. In “Invertebrate Medicine.” (G.A. Lewbart ed.), pp 221–234. Blackwell Publishing, Ames, IA.
- Bower, J.R., Sakurai, Y., Yamamoto, J., and Ishii, H. (1999). Transport of the ommastrephid squid *Todarodes pacificus* under cold-water anesthesia. *Aquaculture* **170**, 127–130.
- Brown, P.B., White, M.R., Chaille, J., Russell, M., and Oseto, C. (1996). Evaluation of three anesthetic agents for crayfish (*Orconectes virilis*). *J. Shellfish Res.* **15**(2), 433–435.
- Clark, T.R., Nossou, P.C., Aplan, J.P., and Filbert, M.G. (1996). Anesthetic agents for use in the invertebrate sea snail, *Aplysia californica*. *Contemp. Top. Lab. Anim. Sci.* **35**(5), 75–79.
- Cooper, E.L. (1968). Transplantation immunity in annelids. *Transplantation* **6**(3), 322–337.
- Cooper, E.L., and Roch, P. (1986). Second-set allograft responses in the earthworm *Lumbricus terrestris*. *Transplantation* **41**(4), 514–520.
- Cooper, J.E. (2001). Invertebrate anesthesia. In “Exotic Anesthesia and Analgesia.” (D. Heard, ed.), *Vet. Clin. North Am. Exot. Anim. Pract.* **4**(1), 57–67.
- Cooper, J.E. (2006). Insects. In “Invertebrate Medicine.” (G.A. Lewbart, ed.), pp 205–219. Blackwell Publishing, Ames, IA.
- Costello, D.P., and Henley, C. (1971). “Methods of Obtaining and Handling Marine Eggs and Embryos,” 2nd ed., pp 247–250. Marine Biological Laboratory, Woods Hole, MA.
- Culloty, S.C., and Mulcahy, M.F. (1992). An evaluation of anesthetics for *Ostrea edulis* (L.). *Aquaculture* **107**(2–3), 249–252.
- Dombrowski, D.S. (2006). Laws, rules, and regulating agencies for invertebrates. In “Invertebrate Medicine.” (G.A. Lewbart, ed.), pp 275–295. Blackwell Publishing, Ames, IA.
- Edwards, S., Burke, C., Hindrum, S., and Johns, D. (2000). Recovery and growth effects of anaesthetic and mechanical removal on greenlips (*Haliotis laevigata*) and blacklip (*Haliotis rubra*) abalone. *J. Shellfish Res.* **19**(1), 510.
- Ferraro, E.A., and Pressacco, L. (1996). Anesthetic procedures for crustaceans. An assessment of isobutanol and xylazine as general anaesthetics for *Squilla mantis* (Stomatopoda). *Mem. Biol. Mar. Oceanogr.* **12**, 471–475.
- Fiorito, G. (1986). Is there “pain” in invertebrates? *Behav. Proc.* **12**, 383–388.
- Flores, D.V., Salas, P.J.L., and Vedra, J.P.S. (1983). Electoretinography and ultrastructural study of the regenerated eye of the snail, *Cryptomphallus aspera*. *J. Neurobiol.* **14**(3), 167–176.
- Frye, F. (2006). Scorpions. In “Invertebrate Medicine.” (G.A. Lewbart, ed.), pp 169–177. Blackwell Publishing, Ames, IA.
- Garcia-Franco, M. (1992). Anaesthetics for the squid *Sepioteuthis sepioidea* (Mollusca: Cephalopoda). *Comp. Biochem. Physiol.* **103C**(1), 121–123.
- Gardner, C. (1997). Options for immobilization and killing crabs. *J. Shellfish Res.* **16**(1), 219–224.

- Girdlestone, D., Cruickshank, S.G.H., and Winlow, W. (1989). The actions of 3 volatile anaesthetics on the withdrawal response of the pond snail, *Lymnaea stagnalis*. *Comp. Biochem. Physiol.* **92C**(1), 39–43.
- Gleadow, I.G. (1991). Comparison of anaesthetics for octopuses. *Bull. Mar. Sci.* **49**(1–2), 663.
- Gleadow, I.G. (2006). Personal communication/unpublished data.
- Gore, S.R., Harms, C.A., Kukanich, B., Forsythe, J., Lewbart, G.A., and Papich, M.G. (2005). Enrofloxacin pharmacokinetics in the European cuttlefish, *Sepia officinalis*, after a single i.v. injection and bath administration. *J. Vet. Pharmacol. Ther.* **28**, 433–439.
- Gunkel, C., and Lewbart, G.A. (2007). Invertebrates. In “Zoo Animal & Wildlife Immobilization and Anesthesia”, (G. West, D. Heard, N. Caulkett eds.) pp. 147–158. Blackwell Publishing, Ames, IA.
- Hackendahl, N., and Mashima, T.Y. (2002). Considerations in aquatic invertebrate euthanasia. In “Proceedings of the American Association of Zoo Veterinarians,” pp 324–329. AAZV organization.
- Harms, C.A. (2006). Echinoderms. In “Invertebrate Medicine.” (G.A. Lewbart, ed.), pp 245–256. Blackwell Publishing, Ames, IA.
- Harms, C.A., Lewbart, G.A., Woolard, K.D., McAlarney, R., Christian, L.S., Geissler, K.A., and Lemons, C. (2006). Surgical excision of mycotic (*Cladosporium* sp.) granulomas from the mantle of a cuttlefish (*Sepia officinalis*). *Proc. Int. Assoc. Aquat. Anim. Med.* **37**, 154–155.
- Heasman, M.P., O'Connor, W.A., and Frazer, A.W.J. (1995). Induction of anesthesia in the commercial scallop, *Pecten fumatus* Reeve. *Aquaculture* **131**, 231–238.
- Hendler, G., Miller, J.E., Pawson, D.L., and Kier, P.M. (1995). “Sea Stars, Sea Urchins and Allies: Echinoderms of Florida and the Caribbean,” pp 21–27. Smithsonian Institution Press, Washington, DC.
- Jones, D., and Candido, E.P.M. (1999). Feeding is inhibited by sublethal concentrations of toxicants and by heat stress in the nematode *Caenorhabditis elegans*: Relationship to the cellular stress response. *J. Exp. Zool.* **284**, 147–157.
- Jooisse, J., and Lever, J. (1959). Techniques for narcotization and operation for experiments with *Lymnaea stagnalis* (Gastropoda Pulmonata). *Proc. K. Ned. Akad. Wet. C* **62**, 145–149.
- Kavaliers, M. (1988). Evolutionary and comparative aspects in nociception. *Brain Res. Bull.* **21**, 923–931.
- Kavaliers, M., and Hirst, M. (1983). Tolerance to morphine-induced thermal response in terrestrial snail, *Cepaea nemoralis*. *Neuropharmacology* **22**, 1321–1326.
- Kavaliers, M., Hirst, M., and Teskey, G.C. (1983). A functional role for an opiate system in snail thermal behavior. *Science* **220**(4592), 99–101.
- Lewbart, G. and Riser, N. (1996). Nuchal organs of the polychaete *Parapionosyllis manca* (Syllidae). *Invert. Biol.* **115**(4), 286–298.
- Lewbart, G.A. (2006). In “Invertebrate Medicine.” (G.A. Lewbart, ed.), pp 3–5. Blackwell Publishing, Ames, IA.
- Lewbart, G.A., and Harms, C.A. (1999). Building a fish anesthesia delivery system. *Exot. DVM* **1**(2), 25–28.
- Madsen, B., and Vollrath, F. (2000). Mechanism and morphology of silk dawn from anesthetized spiders. *Naturwissenschaften* **87**, 149–153.
- Marks, D.H., and Cooper, E.L. (1977). *Aeromonas hydrophila* in the coelomic cavity of the earthworms *Lumbricus terrestris* and *Eisenia foetida*. *J. Invertibr. Pathol.* **29**, 382–383.
- Martins-Sousa, R.L., Negrao-Correa, D., Bezerra, F.S.M., and Coelho, P.M.Z. (2001). Anesthesia of *Biomphalaria* spp. (Mollusca, Gastropoda): Sodium pentobarbital is the drug of choice. *Mem. Inst. Oswaldo Cruz* **96**(3), 391–392.
- Mather, J.A. (2001). Animal suffering: An invertebrate perspective. *J. Appl. Anim. Welf. Sci.* **4**(2), 151–156.
- McCurley, R.S., and Kier, W.M. (1995). The functional morphology of starfish tube feet: The role of a crossed-fiber helical array in movement. *Biol. Bull.* **188**, 197–209.
- Melidone, R., and Mayer, J. (2005). How to build an invertebrate surgery chamber. *Exot. DVM* **7**(5), 8–10.
- Messenger, J.B., Nixon, M., and Ryan, K.P. (1985). Magnesium chloride as an anesthetic for cephalopods. *Comp. Biochem. Physiol.* **82C**(1), 203–205.
- Mills, D., Tlili, A., and Norton, J. (1997). Large-scale anesthesia of the silver-lip pearl oyster, *Pinctada maxima* Jameson. *J. Shellfish Res.* **16**(2), 573–574.
- Morgan, P.G., and Cascorbi, H.F. (1985). Effect of anesthetics and a convulsant on normal and mutant *Caenorhabditis elegans*. *Anesthesiology* **62**, 738–744.
- Morgan, P.G., Sedensky, M., and Meneely, P.M. (1990). Multiple site of action of volatile anesthetics in *Caenorhabditis elegans*. *Proc. Natl. Acad. Sci. U.S.A.* **87**, 2965–2985.
- Müller, M.C.M., Berenzen, A., and Westheide, W. (2003). Experiments on anterior regeneration in *Eurythoe complanata* (Polychaeta: Amphinomidae): Reconfiguration of the nervous system and its function for regeneration. *Zoomorphology* **122**(2), 95–103.
- Murray, M.J. (2006). Euthanasia. In “Invertebrate Medicine.” (G.A. Lewbart, ed.), pp 303–304. Blackwell Publishing, Ames, IA.
- Mutani, A. (1982). A technique for anaesthetizing pulmonate snails of medical and veterinary importance. *Z. Parasitenkd.* **68**, 117–119.
- Nelson, F.K., and Riddle, D.L. (1984). Functional study of the *Caenorhabditis elegans* secretory-excretory system using laser microsurgery. *J. Exp. Zool.* **231**, 45–56.
- Nicholls, J.G., and Baylor, D.A. (1968). Specific modalities and receptive fields of sensory neurons in the C leech. *J. Neurophysiol.* **31**, 740–756.
- Nicolas, G., and Sillans, D. (1989). Immediate and latent effects of carbon dioxide on insects. *Ann. Rev. Entomol.* **34**, 97–116.
- Noga, E.J., Hancock, A.L., and Bullis, R.A. (2006). Crustaceans. In “Invertebrate Medicine.” (G.A. Lewbart, ed.), pp 179–193. Blackwell Publishing, Ames, IA.
- Norton, J.H., Dashorst, M., Lansky, T.M., and Mayer, R.J. (1996). An evaluation of some relaxants for use with pearl oysters. *Aquaculture* **144**, 39–52.
- O'Neill, P.L. (1994). The effect of anesthesia on spontaneous contraction of the body wall musculature in the astereroid *Coscinasterias calamaria*. *Mar. Behav. Physiol.* **24**, 137–150.
- Oswald, R.L. (1977). Immobilization of decapod crustaceans for experimental purposes. *J. Mar. Biol. Assoc. U.K.* **57**, 715–721.
- Pizzi, R., and Ezendam, T. (2002). So much for sutures. *Forum Mag Am Tarantula Soc.* **11**, 122–123.
- Pizzi, R. (2006). Spiders. In “Invertebrate Medicine.” (G.A. Lewbart, ed.), pp 143–168. Blackwell Publishing, Ames, IA.
- Poole, T. (1999). “UFAW Handbook on the Care and Management of Laboratory Animals,” Vol. 2, Pt 3, 7th ed. Blackwell Publishing, Ames, IA.
- Redmond, J.R., Jorgensen, D.D., and Bourne G.B. (1982). Circulatory physiology of *Limulus*. *Prog. Clin. Biol. Res.* **81**, 133–146.
- Reilly, R.S. (2001). “Euthanasia of Animals Used for Scientific Purposes,” 2nd ed., pp 98–99. ANZCCART, Adelaide University, Adelaide, Australia.
- Ruppert, E.E., and Barnes, R.D. (1994). “Invertebrate Zoology,” 6th ed., 1056pp. Saunders College Publishing, Saunders, Philadelphia, PA.
- Ruppert, E.E., Fox, R.S., and Barnes, R.D. (2004). “Invertebrate Zoology: A Functional Evolutionary Approach,” 7th ed., 963pp. Thompson-Brooks/Cole, Belmont, CA.
- Saksida, L.M., Galea, L.A., and Kavaliers, M. (1993). Antinociceptive effects of the enkephalinase inhibitor, SCH 34826, in the snail, *Cepaea nemoralis*. *Peptides* **14**(4), 763–765.
- Scimeca, J.M., and Forsythe, J.W. (1999). The use of anesthetic agents in cephalopods. *Proc. Int. Assoc. Aquat. Anim. Med.* **27**, 88.
- Scimeca, J.M. (2006). Cephalopods. In “Invertebrate Medicine.” (G.A. Lewbart, eds), pp 79–89. Blackwell Publishing, Ames, IA.
- Sherwin, C.M. (2001). Can invertebrates suffer? Or, how robust is argument-by-analogy? *Anim. Welf.* **10**, S103–S118.
- Smith, J. (1991). A question of pain in invertebrates. *ILAR J.* **33**(1–2), 25–31.
- Smith, S.A. (2006). Horseshoe crab. In “Invertebrate Medicine” (G.A. Lewbart, ed.), pp 133–142. Blackwell Publishing, Ames, IA.

- Smith, S.A., and Berkson, J. (2005). Laboratory culture and maintenance of the horseshoe crab (*Limulus polyphemus*). *Lab. Anim.* **34**(7), 27–34.
- Spotswood, T., and Smith, S.A. (2007). Cardiovascular and gastrointestinal radiographic contrast studies in the horseshoe crab (*Limulus polyphemus*). *Vet. Radiol. Ultrasound* **48**(1), 14–20.
- Styrishave, B., Andersen, O., and Depledge, M.H. (2003). In situ monitoring of heart rates in shore crabs *Carcinus maenas* in two tidal estuaries: Effects of physico-chemical parameters on tidal and diel rhythms. *Mar. Fresh Behav. Physiol.* **36**(3), 161–175.
- Tettamanti, G., Grimaldi, A., Ferrarese, R., Palazzi, M., Perletti, G., Valvassori, R., Cooper, E.L., Lanzavecchia, G., and de Eguileor, M. (2003). Leech responses to tissue transplantation. *Tissue Cell* **35**, 199–212.
- Thomas, A.W., Kavaliers, M., Prato, F.S., and Ossenkopp, K.P. (1997). Antinociceptive effects of a pulsed magnetic field in the land snail, *Cepaea nemoralis*. *Neurosci. Lett.* **222**(2), 107–110.
- Tobin, D.M., and Bargmann, C.I. (2004). Invertebrate nociception: Behaviors, neurons and molecules. *J. Neurobiol.* **61**, 161–174.
- Valles, S.M., and Koehler, P.G. (1994). Influence of carbon dioxide anesthesia on chlopyrifos toxicity in the German cockroach (Dictyoptera: Blattellidae). *J. Econ. Entomol.* **87**(3), 709–713.
- Van den Spiegel, D., and Jangoux, M. (1987). Cuvierian tubules of the holothuroid *Holothuria forskali* (Echinodermata): A morphofunctional study. *Mar. Biol.* **96**, 263–275.
- Walcourt, A., and Ide, D. (1998). A system for the delivery of general anesthetics and other volatile agents to the fruit-fly *Drosophila melanogaster*. *J. Neurosci. Methods* **84**, 115–119.
- Walls, E.A., Berkson, J., and Smith, S.A. (2002). The horseshoe crab, *Limulus polyphemus*: 200 Million years of existence, 100 years of study. *Rev. Fish. Sci.* **10**, 39–73.
- White, H.I., Hecht, T., and Potgieter, B. (1996). The effect of four anaesthetics on *Halilotis midae* and their suitability for application in commercial abalanone culture. *Aquaculture* **140**, 145–151.
- Wood, J.B., and Anderson, R.C. (2004). Interspecific evaluation of octopus escape behavior. *J. Appl. Anim. Welf. Sci.* **7**(2), 95–106.
- Woodall, A.J., and McCrohan, C.R. (2000). Excitatory actions of propofol and ketamine in the snail *Lymnaea stagnalis*. *Comp. Biochem. Physiol.* **127C**, 297–305.
- Woodall, A.J., Naruo, H., Prince, D.J., Feng, Z.P., Winlow, W., Takasaki, M., and Syed, N.I. (2003). Anesthetic treatment blocks synaptogenesis but not neuronal regeneration of cultured *Lymnaea* neurons. *J. Neurophysiol.* **90**, 2232–2239.

This page intentionally left blank

Section V

**Special Topics in Anesthesia and Analgesia
of Laboratory Animals**

This page intentionally left blank

Pain Testing in the Laboratory Mouse

Dale J. Langford and Jeffrey S. Mogil

I. Introduction	549
II. Experimental Models of Acute/Tonic Pain	550
A. Thermal Assays	551
B. Mechanical Assays	552
C. Chemical Assays	553
III. Experimental Models of Chronic Pain	554
A. Inflammatory Models	554
B. Neuropathic Models	554
IV. Modulating Factors	556
A. Strain Differences	556
B. Sex Differences	556
C. Age Differences	556
D. Circadian Effects	556
E. Experimenter Effects	557
F. Social Context Effects	557
V. New Directions in Animal Pain Testing	557
References	557

I. INTRODUCTION

Pain is a complex, multidimensional, and ultimately subjective experience, importantly influenced by cognitive and sociocultural factors, and thus humans are the ideal subjects for pain research. However, there are obvious limitations to the study of pain in humans, and thus conducting pain research in animals is necessary and unavoidable if we are to attempt to improve on the clinical treatment of pain in our species and others. Such improvement is highly sought after, since

current pain therapies feature limited efficacy and/or problematic side effects. In the laboratory, the vast majority of modern pain research has been performed in the rodent, especially in the rat and the mouse. Given that *Mus musculus* is gaining popularity as a pain research subject (Fig. 23-1) (largely due to the ability to produce transgenic knockouts in this but not other species), and that our particular expertise lies with this species, this chapter will concentrate on pain testing in the laboratory mouse.

Creating reliable and valid models of a complex human condition in a 30 g mammal is hardly trivial and has proceeded

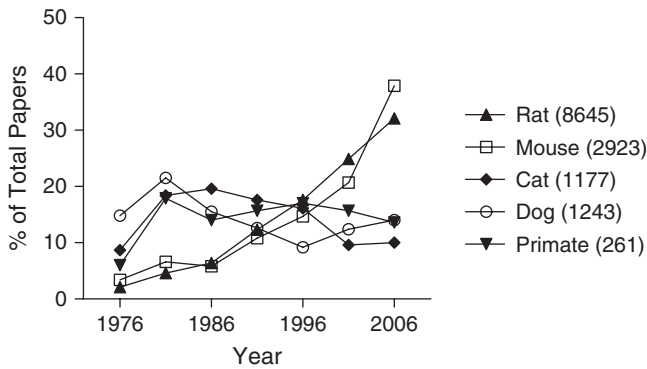

Fig. 23-1 Nonhuman research subjects in pain experiments in the past 30 years. Data are based on a PubMed search conducted on November 16, 2006, using the MeSH term “Pain” combined using the AND operator with the MeSH terms “Rats”, “Mice”, “Cats”, “Dogs” or (“Primates” NOT “Humans”). The total number of hits is given in parentheses beside the species name. Symbols represent percentage of total papers added in the 5-year period ending with the year shown in the ordinate. As can be seen, whereas the use of cats, dogs, and nonhuman primates is steady or declining, the use of rats and mice continues to increase. The last 5-year period saw a large spike in mouse usage in pain research, with 38% of data-based papers in this species published between 2001 and 2006.

continuously for the entire history of pain research. In this chapter, we will present currently used acute, tonic, and chronic models of pain (see Tables 23-1 and 23-2 for a summary). We will discuss their common parameters, advantages, disadvantages, and ethical considerations, as well as important and often overlooked issues to consider during their use. We do not aim to produce an exhaustive list, including only the most popular models at the present time.

A few notes on nomenclature. First, it is considered proper when referring to non-human subjects to refer simply to “nociception” and “antinociception” instead of “pain” and “analgesia.” However, because the former terms are unwieldy and we do not necessarily agree that humans have a qualitatively different experience than nonhuman animals, we have opted to use the words “pain” and “analgesia” throughout. Second, clinical pain syndromes feature, in addition to spontaneous pain, increased sensitivity to thermal (hot and cold) and mechanical evoking stimuli. These symptoms include hyperalgesia (increased responses to noxious stimuli) and allodynia (responses to normally non-noxious stimuli), both of which ultimately represent shifts to the left of the stimulus intensity–response curve. It is difficult to unambiguously separate the two in animal experiments involving threshold measurements, and so we will use the term “hypersensitivity” throughout.

II. EXPERIMENTAL MODELS OF ACUTE/TONIC PAIN

Mammalian nociceptors are activated by a number of stimuli—which may or may not produce frank tissue damage—including heat, cold, mechanical pressure, and chemicals. Many animal models of pain simply involve exposing the subject to such stimuli, and quantifying behavioral responses to them, ranging from reflex withdrawal to organized, recuperative behaviors. Most of these models have been in use for several decades, and are commonly used both to establish baseline pain sensitivity of an individual animal, as well as to quantify injury-induced changes and analgesic ameliorations. As the noxious

TABLE 23-1
COMMON ACUTE/TONIC PAIN ASSAYS IN THE MOUSE, AND THEIR ADVANTAGES AND DISADVANTAGES

Type	Assay	Advantages	Disadvantages
Thermal	Tail-flick	Speed and ease of use	Low clinical relevance
	Tail-withdrawal	No effect of repeated testing	Requires restraint
	Hot-plate	Speed and ease of use No restraint required	Low clinical relevance Complex behaviors Repeated testing effects
	Paw-withdrawal	No restraint required Can test contralateral hindpaw No effect of repeated testing	Low clinical relevance Long habituation time
Cold	Acetone	Speed and ease of use	No response in uninjured subjects
Mechanical	Tail-clip	Speed and ease of use	Repeated testing effects Severely confounded by ataxia
	von Frey filament	Used in humans	Long habituation time Hard to standardize across labs
Chemical	Formalin	Higher clinical relevance Spontaneous behaviors	Complex time course
	Abdominal constriction	Sensitive to weak analgesics	Lack of specificity Nonresponders

TABLE 23-2
COMMON CHRONIC PAIN ASSAYS IN THE MOUSE

Type	Assay	Description
Inflammatory	Complete Freund's adjuvant	Produces inflammation and related pain/hypersensitivity in a target tissue
Neuropathic Surgical	Chronic constriction injury (CCI)	Three or four loose ligatures are tied around the sciatic nerve; resulting local inflammation strangles some proportion of afferent fibers; produces mechanical, cold and heat hypersensitivity of the ipsilateral hindpaw
	Partial sciatic nerve ligation (PSL)	A tight ligation of one-third to one-half of the sciatic nerve is made; produces mechanical, cold and heat hypersensitivity of the ipsilateral hindpaw
	Spinal nerve ligation (SNL)	A tight ligation of the L5 (or L5 + L6) spinal nerve is made, leaving the other spinal nerve(s) intact; produces mechanical, cold and heat hypersensitivity of the ipsilateral hindpaw
	Spared nerve injury (SNI)	A tight ligation of two of the three branches of the sciatic nerve (peroneal, tibial, sural) is made, leaving the third branch intact; produces mechanical and cold hypersensitivity of the ipsilateral hindpaw
Chemotherapeutic	Vincristine, paclitaxel	Subjects given multiple drug administrations over a period of days to weeks; produces whole-body hypersensitivity

stimulus is transient and usually escapable in these tests, their use presents no serious ethical concerns.

A. Thermal Assays

These tests employ the latency to respond to a noxious thermal stimulus as the dependent measure, as a proxy of the nociceptive threshold. In all cases, a "cut-off" latency (e.g., three times the baseline latency) is employed to prevent the possibility of tissue damage in nonresponding subjects. These tests have considerable face validity as models of acute pain, and are effective in predicting the analgesic efficacy of opioids (Taber, 1974) (but not other analgesic drug classes) (Hammond, 1989). Hypersensitivity to thermal stimuli is a common (if easily avoidable) symptom of chronic pain conditions.

1. Tail-Flick (radiant heat) and Tail-Withdrawal (hot water) Tests

In the tail-flick test, the animal is briefly restrained, with its tail extended on a flat surface. A heat stimulus of fixed intensity is applied to the cutaneous skin of the tail (usually from below), and the time required for the animal to flick (i.e., withdraw) its tail from the stimulus is recorded. In the tail-withdrawal test, the animal is gently restrained while the distal half of its tail is immersed in a water bath (46–52°C), and the time elapsed between immersion and purposeful withdrawal of the tail from the bath is recorded. In both cases, the behavior is a (well-studied) spinal reflex (Irwin et al., 1951), albeit one under control of supraspinal structures (Basbaum and Fields, 1984). The two tests differ with respect to the kinetics of heat transfer into the tail, and with respect to stimulated surface areas (Le Bars et al., 2001), but we are unaware of any published

dissociation of results obtained from one vis-à-vis the other. Neither test appears to be sensitive to repeated testing as long as the inter-test interval (i.e., the time between successive latency determinations) is sufficiently long, say, >1–2 minutes (Mogil et al., 2001).

Restraint stress has been shown to significantly modify behavioral and physiological responses to pain (i.e., stress-induced analgesia) (Porro and Carli, 1988), potentially affecting the animal's baseline pain sensitivity. We have shown that gentle restraint in a cloth/cardboard holder produces less stress-induced analgesia than immobilization in a Plexiglas cylinder (Mogil et al., 2001). Another important factor to consider when using these tests is the ambient temperature, which strongly affects the tail temperature (Tjolsen and Hole, 1993).

2. Hot-plate Test

The hot-plate test also utilizes latency measurements to assess acute, cutaneous pain sensitivity; however, in this test the scored behavioral responses are supraspinally organized. Animals are placed, one by one, on a surface maintained at 50–56°C, with their locomotion restricted by a Plexiglas cylinder. The latency to hindpaw licking and/or shaking, or jumping, is recorded, and at this point the animal is immediately removed from the hot plate.

The hot-plate test is also a quick and relatively inexpensive way to assess acute, thermal pain, and an advantage over tail-flick/tail-withdrawal is the opportunity to test thermal sensitivity unconfounded by stress-induced analgesia associated with restraint (see above). However, the hot-plate test is somewhat more complicated than other thermal assays, because rodents (especially rats) exhibit rather complex and subtle behavioral repertoires (Carter, 1991; Espejo and Mir, 1993), and the behaviors can be genotype-dependent (Belknap et al., 1990). Because

these behaviors require motor coordination, longer latencies on the hot-plate test could be due to side effects of the treatment rather than to analgesia per se (Hammond, 1989). The hot-plate test is also very sensitive to repeated measurements, likely via learning (Espejo and Mir, 1994; Milne et al., 1989; Plone et al., 1996), a distinct disadvantage for its use.

3. *Radiant Heat Paw-Withdrawal (Hargreaves') Test*

This assay was developed in 1988 (Hargreaves et al., 1988), with the aim of quantifying changes in thermal pain indicative of hypersensitivity on one side of the body. Animals are placed in Plexiglas cubicles on a glass floor. After habituation to the testing chambers (which in mice, depending on strain, can take several hours), the experimenter positions a light box equipped with a high-intensity bulb below the glass floor. A pilot light (~5% maximum intensity) helps accurately position the stimulus below the appropriate hindpaw, and once positioned the experimenter applies a light beam of a pre-chosen intensity and initiates an internal timer. When the animal lifts, shakes, and/or licks the stimulated hindpaw, the experimenter terminates the stimulus and stops the timer.

Unlike other thermal assays, the paw-withdrawal test allows the independent testing of both sides of the body, affording an internal control (i.e., ipsilateral vs. contralateral paw), increasing power, and reducing the number of animals required for a given experiment. Latencies in this test are unchanged with repeated testing, and it requires less hands-on experimenter interaction, an important source of variability (Chesler et al., 2002a, 2002b; Crabbe et al., 1999).

4. *Cold Stimuli*

It is considerably less common to employ noxious cold stimuli in pain research compared to noxious heat stimuli, although many chronic pain syndromes feature troublesome cold hypersensitivity. Many of the aforementioned heat pain tests have been modified to use cold stimuli, including the cold water/ethanol tail-withdrawal test (Pizziketti et al., 1985) and the cold-plate test (Jasmin et al., 1998).

Acetone application has also been commonly used to assess sensitivity to cold (Choi et al., 1994). Upon contact with the skin, it spreads and evaporates causing a cooling sensation that is normally perceived as innocuous. Nerve-injured rats respond with brisk paw withdrawals and extended bouts of postwithdrawal shaking and licking.

B. Mechanical Assays

Tests of pain using mechanical stimuli are far less reliable than thermal tests, but arguably far more important, since mechanical hypersensitivity (unlike thermal hypersensitivity)

is a major clinical problem. The mechanical allodynia experienced by chronic pain sufferers causes them to avoid any contact with their affected limb, and can render even everyday activities like dressing exquisitely painful. In addition to the two tests described below, the Randall–Selitto test (1957) of withdrawal from pressure applied to the paw is commonly used in the rat, but the level of restraint necessary for its proper use is not practical in the mouse (Mogil et al., 2001).

1. *Tail-Clip Test*

In this test (Haffner, 1929; Takagi et al., 1966), a constant, suprathreshold pressure stimulus is applied to the tail. The animal is briefly restrained and a metal artery or binder clip is applied to the tail near its base. The test animal is then immediately released and the latency to lick, bite, grab, or bring the nose to within 1 cm of the clip is recorded. A cut-off latency is used for nonresponders.

The tail-clip test is very quick and easy to administer, and the force exerted by the clip can be modified according to experimental requirements. However, in our experience the assay is extremely sensitive to repeated testing, so only one measurement per animal may be obtained. Another problem posed by the tail-clip test is placement of the clip. Despite efforts to maintain the same position on each subject, the exact angle and position at which the clip is applied may vary across test subjects. Finally, the test is subject to confounding by motor ataxia, and it may be difficult to dissociate whether a target drug has affected an animal's pain sensitivity, or simply its physical ability to make goal-directed movements.

2. *von Frey Filament Test*

von Frey fibers, originally individual mammalian hairs attached to a rod (von Frey, 1922) and now made of nylon, are used to this day to assess sensory detection thresholds in humans. This test has been used in animal pain research as early as 1960 (see Bove, 2006 for review), and is the most commonly used method of studying mechanical hypersensitivity. The fibers vary in diameter, and are calibrated to exert a maximal vertical force at the point of bending.

Animals are habituated to Plexiglas cubicles (again, requiring several hours in most mouse strains), which rest on a wire mesh floor (and the floor material has been shown to matter; Pitcher et al., 1999). The fiber is applied to the plantar surface of the hindpaw, and the presence or absence of a response (paw withdrawal) is recorded. Several psychophysical protocols of applying these fibers are in common use, and there is an ongoing debate as to which technique yields the most accurate results. The up-down method of Dixon (Chaplan et al., 1994) yields a measure of an individual's 50% withdrawal threshold by applying up to eight fibers in sequential order, with each presentation dependent on prior responses. Alternative methods involve the

use of only two or three fibers (small and large diameter), or the presentation of fibers in an ascending series.

Physical particularities of the fiber, as well as subtle variations in the placement of the fiber, can significantly affect mechanical thresholds making it difficult to standardize testing (Bove, 2006). Rodents display significant variability in this assay (even within-strain), and often, repeated measurements are necessary in order to obtain an accurate threshold. Debate continues among pain researchers as to whether an animal's withdrawal response actually represents a withdrawal from pain, or is simply a response to being repeatedly prodded.

C. Chemical Assays

The following models assay spontaneous pain behaviors elicited by injection of chemical irritants. These assays can be referred to as "tonic" because the pain associated with the stimulus is longer in duration (and inescapable), thus differentiating them from the acute models discussed above. They thus present more serious ethical concerns, but because of their longer duration and spontaneously emitted responses, they may also be more clinically relevant.

1. Formalin Test

The formalin test, originally described by Dubuisson and Dennis (1977), is a model of tonic inflammatory pain associated with tissue damage. This test has been reviewed at length previously (Porro and Cavazzuti, 1993; Tjolsen et al., 1992). After habituation, the animal is injected subcutaneously in the dorsal or (more commonly) plantar surface of the hindpaw with 20–50 μ l (mice—rats) of 1 to 5% formalin. The formalin causes inflammation and stereotypic licking and biting of the affected hindpaw. In the rat, other behaviors are commonly seen, including hindpaw lifting and flinching, but we and others have shown that licking/biting is all that needs to be scored in the mouse (Sufka et al., 1998). Video recording allows for increased convenience and accuracy. Additionally, scoring formalin behaviors using an interval sampling method has been shown to be accurate and significantly more efficient (Abbott et al., 1999; Chesler et al., 2003).

Behaviors are generally scored for 40–90 minutes postinjection, and occur in a biphasic temporal pattern, with an "early" or "acute" phase of licking/biting (5–10 minutes), followed by a quiescent period (10–20 minutes) and then a "late" or "tonic" phase of licking/biting behaviors occurring in bouts of a few minutes each. Early phase licking appears to be due to a direct effect of the formalin injection on nociceptors, and the late phase due to a central sensitization and subsequent peripheral inflammation (Tjolsen et al., 1992). As such, the late phase is generally of greater interest as a clinically relevant model.

Although the formalin test imposes inescapable pain and tissue damage, the duration of pain is relatively brief and justified

for its purposes as a clinically valid model of pain. Normal use of the paw is generally observed within 2 hours of testing (Dubuisson and Dennis, 1977); however, animals are often euthanized immediately post-testing to measure hindpaw edema. We recommend this strongly as a way of identifying "bad" injections evidenced by lack of inflammation.

2. Abdominal Constriction Test

The abdominal constriction test is an experimental model of visceral pain (Koster et al., 1959; Siegmund et al., 1957; van der Wende and Margolin, 1956) (although poorly suited as such because it involves the muscle wall of the abdomen as well), and can be conducted using a number of chemical irritants, such as bradykinin, magnesium sulfate, phenylquinone, hyper- or hypotonic saline, and adenosine triphosphate (ATP). Historically, acetic acid has been the most commonly used irritant.

After habituation, the animal is injected intraperitoneally with 10 ml/kg of 0.1–0.9% glacial acetic acid. Animals are scored for the presence or absence of "writhing"—a stereotypic behavior governed by a brain stem reflex and characterized by lengthwise stretching of the torso with concomitant concave arching of the back and extension of the hindlimbs—for 30–40 minutes postinjection. As with the formalin test, video recording allows for increased efficiency and productivity, and videos can be scored continuously (total number of writhes) or sampled, which we have shown to produce significantly higher inter-rater reliability (Langford et al., 2006).

The writhing test is often criticized for its lack of specificity, as nonanalgesic drugs have been shown to effectively reduce writhing behavior; however, it remains an important experimental model of pain because of its unique sensitivity to weak analgesics (Hammond, 1989). Thus, the pain induced by acetic acid is relatively mild and brief enough in duration to be ethically acceptable. The test has also been criticized for its relatively high proportion of nonresponders (approximately 8%; Ness and Gebhart, 1990), although this proportion can be reduced by using higher doses of acetic acid.

3. Other Tonic Pain Models

The formalin test especially has been criticized for using a highly artificial noxious stimulus (formaldehyde), which produces unnecessary tissue damage. A few alternatives have been developed. Capsaicin (2.5 μ g) injection into the skin produces apparent spontaneous pain behaviors (licking, biting) which last for 5–10 minutes, followed by a hypersensitivity lasting for a few hours. This test is favored by some because capsaicin is used commonly for human experimental pain testing, and because capsaicin acts directly at the transient receptor potential, family V, member 1 (TRPV1) channel, an important transducer molecule for pain (Caterina et al., 1997). A clever variant of the formalin test uses subcutaneous injection of honeybee

venom (Lariviere and Melzack, 1996), which also produces licking/biting behaviors followed by hypersensitivity.

Much clinical pain is of deep muscle tissues and/or visceral organs, and thus an increasing number of researchers have adapted some of these tonic models to specifically study muscle pain or visceral pain. A full review is beyond the scope of this chapter, but popular current models include repeated hypertonic saline injections into muscle (Sluka et al., 2001), cyclophosphamide cystitis of the bladder (Bon et al., 2003; Olivar and Laird, 1999), and colorectal distention with or without irritant injection (Martinez et al., 1996; Ness and Gebhart, 1988).

III. EXPERIMENTAL MODELS OF CHRONIC PAIN

Clinical pain lasting more than a few hours can usually be traced to either ongoing inflammation or nerve damage. (In many cases clinicians can find evidence of neither, but one can still assume their presence.) Once considered entirely different states, many pain researchers now maintain that neuropathic pain and inflammatory pain are far more similar than different (Bennett, 2006). A plethora of models have been developed in an attempt to produce such injury states in animals so that the concomitant pain and hypersensitivity, which lasts from days to months, can be studied. Obviously, the ethical concerns surrounding the use of such models are considerably more serious than those described above, but can be justified based on their more obvious clinical relevance.

A. Inflammatory Models

The high prevalence of arthritis makes this disorder the major focus of chronic inflammatory pain models, and concerted efforts have been made to develop animal models in order to better understand the disease at the cellular and molecular level. Clinically, arthritis is characterized by inflammation of the joint(s), and features spontaneous pain and hypersensitivity to evoking stimuli. Despite the fact that the presenting complaint of arthritis sufferers is pain, arthritis researchers are often uninterested in this symptom, and in the vast majority of studies using arthritis models (e.g., collagen-induced arthritis, oil-induced arthritis, pristane-induced arthritis, streptococcal cell wall arthritis), pain measurement is not attempted.

1. Adjuvant-Induced Arthritis

The systemic administration of adjuvant (e.g., into the tail) (Pearson, 1956; Pircio et al., 1975) results in polyarthritis with severe side effects, imposing extreme discomfort on experimental animals and producing global changes not reflective of arthritis pathology in humans (Butler, 1989). Its use has

thus been diminishing, replaced by various models of unilateral monoarthritis.

Administration (directly into a peripheral joint) of complete Freund's adjuvant (CFA), a commercially available adjuvant comprised of heat-killed *Mycobacterium tuberculosis* in mineral oil, has been established as a model of rheumatoid and osteoarthritis in the rodent (Colpaert et al., 1982; de Castro Costa et al., 1981; Donaldson et al., 1993; Stein et al., 1988). Both CFA and incomplete Freund's adjuvant (i.e., no mycobacteria) injected directly into the hindpaw induce inflammation, but only CFA induces changes in thermal pain sensitivity (Larson et al., 1986). A correlation between inflammation and hypersensitivity is lacking in this model, although this is not necessarily unexpected, as there is a very poor correlation between joint degeneration/inflammation and pain in human arthritis sufferers as well (Gaston-Johansson and Gustafsson, 1990).

2. Other Inflammatory Mediators

A perusal of the literature reveals a large number of noxious substances used by pain researchers to study tonic/chronic inflammatory pain, and especially the activity of nonsteroidal anti-inflammatory drugs (NSAIDs). Typically these compounds are injected into the hindpaw rather than intra-articularly, in order to take advantage of von Frey and paw-withdrawal testing as dependent measures. Those in fairly common current use include carrageenan, endotoxin, mustard oil, zymosan, and kaolin (Maier et al., 1993; Meller and Gebhart, 1997; Winter et al., 1962). Like CFA, there is very little evidence that these compounds produce spontaneous pain, but they all produce robust hypersensitivity and edema over a time course of several hours to days.

B. Neuropathic Models

Although the clinical prevalence of neuropathic pain is likely dwarfed by that of inflammatory pain, it is studied intensely by pain researchers. This is likely because of greater scientific interest (neuropathic pain involves gene expression changes and neural plasticity to a far greater extent than inflammatory pain) and the fact that opioid pharmacotherapy has lower efficacy for neuropathic pain (Arner and Meyerson, 1988), rendering it far more difficult to manage clinically. Early attempts to study neuropathic pain involved peripheral nerve transections (Wall et al., 1979), a model of anesthesia dolorosa and phantom limb pain which features autotomy (i.e., self-mutilation) behavior in rodents. Because of the questionable ethics (although the problem may be more aesthetic than ethical, since mice are completely deafferented) of this paradigm, it is uncommon today. Besides, it is clear that most neuropathic pain syndromes result from *partial* nerve injury, not complete transections. The first behavioral partial deafferentation model was developed in 1988

(Bennett and Xie, 1988), although electrophysiological studies in similar models had been performed previously (Basbaum and Wall, 1976). Since then, a number of additional experimental models of neuropathic pain have been developed in the rat, and later modified for the mouse; the four most commonly used will be described below. What they all have in common is that only *some* of the afferent information from the hindpaw (although some of these models have been adapted to study orofacial pain) has been disrupted. This has allowed the very interesting study of the relative roles of the damaged fibers (i.e., loss of input) and the undamaged fibers (i.e., plasticity) in producing the gain-of-function that is pain and hypersensitivity. Very recently, nonsurgical nerve damage models have been developed based on the clinical findings that painful neuropathy is a dose-limiting side effect of chemotherapy; we will discuss two such models.

All these models produce at least behavioral evidence of mechanical hypersensitivity using punctate stimuli (i.e., von Frey filaments). Some also produce thermal (hot and cold) hypersensitivity, but some do not. The most frequent and troubling symptom of neuropathic pain patients, however, is chronic and/or paroxysmal spontaneous pain, usually described as shooting or burning. For reasons of practicality, relatively little effort has been made to accurately assess spontaneous pain in animals, even though most researchers suspect that it should be there in nerve injury models (Attal et al., 1990; Bennett and Xie, 1988). We believe that this omission represents a key weakness in the usefulness of the models to establish mechanisms and predict drug efficacy in humans (Mogil and Crager, 2004). Others have criticized the reliance on measuring reflex withdrawal thresholds (Jabakhanji et al., 2006; Neubert et al., 2006; Vierck et al., 2004).

1. *Surgical Neuropathic Pain Models*

The original model, called chronic constriction injury (CCI) (Bennett and Xie, 1988), involves exposing the sciatic nerve at mid-thigh level, and tying loose ligatures (silk or chromic gut) around the sciatic nerve. The ligatures are not tied tight enough to transect the nerve, but instead produce local inflammation that effectively strangles some proportion of the afferent fibers. In rats, the model reliably induces mechanical and thermal hypersensitivity, with some evidence of spontaneous pain determined by sudden lifting and licking of the affected hindpaw (Attal et al., 1990; Bennett and Xie, 1988), although the model shows less reliable changes in pain behavior in mice (unpublished observations). It should be noted that although many investigators consider lifting of the hindpaw evidence of spontaneous pain, this behavior could just as easily be due to the animal attempting to avoid mechanical hypersensitivity associated with placing weight on the paw (e.g., when walking). Licking behavior is probably more likely related to spontaneous pain in the hindpaw, but is very rarely observed.

The partial sciatic nerve ligation (PSL) model (Seltzer et al., 1990) also aims directly at the sciatic nerve. The nerve is exposed at high thigh level and one-third to one-half of the diameter of the nerve is isolated and tightly ligated, leaving the remainder of the nerve intact. This manipulation results in rapid onset (1 day), sustained (7–10 weeks) mechanical and thermal hypersensitivity, and apparent spontaneous pain characterized by guarding, and sudden lifting, licking, and biting of the ipsilateral paw. The PSL was the first of these models to be specifically adapted to the mouse (Malmberg and Basbaum, 1998), although all are now done routinely in this species. The PSL model is subject to considerable variability due to the inability to standardize the number of injured fibers; however, the model produces highly reproducible behavioral changes and is less technically difficult than CCI.

Spinal nerve ligation (SNL) (Kim and Chung, 1992) involves tightly ligating the L5 ± L6 spinal nerves, proximal to the dorsal root ganglion, leaving the L4 spinal nerve subserving the hindpaw intact. The surgery results in quick onset of both mechanical and thermal hypersensitivity (evident 4–7 days postsurgery) and also causes sudden bouts of ipsilateral paw licking and toe pulling, behaviors potentially indicative of spontaneous pain. The standardized surgical technique and the ability to specifically injure separate spinal nerves offer an advantage over the previously discussed ligation models; however, the surgical procedure is considerably more invasive and more technically difficult.

A recently developed model gaining great popularity is the spared nerve injury (SNI) model (Decosterd and Woolf, 2000), which involves ligation of branches of the sciatic nerve, and assessing pain sensitivity of the corresponding cutaneous territories. A tight ligature is tied around the common peroneal and tibial branches of the sciatic nerve, leaving the sural branch intact. Robust and sustained (up to 6 months) mechanical hypersensitivity and hypersensitivity to cold (but not heat) stimuli are observed within 1 week of surgery. The authors observed intermittent “sudden sustained spontaneous withdrawal” in the absence of any evoking stimulus, which may represent evidence of spontaneous pain.

2. *Chemotherapeutic Neuropathic Pain Models*

As mentioned above, often painful, neuropathy is a dose-limiting side-effect of a number of commonly used chemotherapeutics. This fact has been exploited to create novel neuropathic pain models whose explication could allow the use of higher and more efficacious doses of drug. The neuropathic symptoms are generally produced using doses lower than those required to cause axonal degeneration in peripheral nerves via their actions on microtubules.

Vincristine (Oncovin[®], Vincasar[®]) injections have been shown to produce neuropathic pain symptoms in the rat (Nozaki-Taguchi et al., 2001; Tanner et al., 1998; Weng et al., 2003) and mouse (Kamei et al., 2005). In mice, animals are injected

(i.p.) with an initial small dose of vincristine, followed by a significantly higher dose administered twice weekly for 6 weeks. Four weeks after the initial injection, mice exhibit significantly increased thermal pain sensitivity on the tail-flick test (Kamei et al., 2005). The signal transduction mechanisms underlying vincristine-induced neuropathic pain have been dissociated from those associated with pain in surgical models (Aley and Levine, 2002).

Also producing neuropathic pain symptoms in rodents is paclitaxel (Taxol[®]) (Authier et al., 2000; Polomano et al., 2001; Smith et al., 2004). In mice (as in rats), four intraperitoneal injections of paclitaxel are administered on alternating successive days, and produce mechanical and cold hypersensitivity (but no heat hypersensitivity), which peaks approximately 11 days post injections. There is evidence that the symptoms (from both drugs) may be secondary to loss of epidermal innervation of sensory fibers (Siau et al., 2006), mitochondrial dysfunction (Flatters and Bennett, 2006), and dysregulation of cellular calcium homeostasis (Siau and Bennett, 2006).

IV. MODULATING FACTORS

A continuing frustration among pain researchers concerns the poor replicability of pain models from one species to another, from one laboratory to another, and even within-laboratory. We have focused over the last 15 years on trying to explain this variability, and find many sources. We hope that the increased attention now being paid to parametric, organismic, and environmental factors impacting laboratory studies of pain will allow more efficient use of animal subjects and more accurate and “translatable” findings. The influence of parametric factors (e.g., stimulus modality, stimulus intensity, stimulus location, time–intensity relationships) has been reviewed at length recently (Le Bars et al., 2001), and so we concentrate below on organismic and environmental modulatory factors.

A. Strain Differences

Our laboratory has documented surprisingly robust differences among inbred laboratory mouse strains on every pain test studied thus far (Lariviere et al., 2002; Mogil et al., 1999a). These strain differences are highly relevant to current murine pain research because the standard background strain on which most transgenic knockouts are bred, C57BL/6, displays very different pain sensitivity than the 129 strains supplying the embryonic stem cells in the creation of those knockouts (Lariviere et al., 2001; Mogil and Grisel, 1998). It is not the case that certain strains are simply more or less sensitive to pain across the board. Instead, we find that sensitivity to pain appears to be inherited in a symptom-specific manner, with particular strains (and thus particular sets of genes) showing sensitivity or

resistance to: (a) thermal pain, (b) chemical pain, (c) afferent-dependent thermal hypersensitivity, (d) afferent-independent thermal hypersensitivity, and (e) mechanical hypersensitivity (Lariviere et al., 2002; Mogil et al., 1999b). We and others have identified a few genes producing some of this variability (Mogil et al., 1997a, 2005; Seltzer et al., 2001), but this task will take a considerable amount of time to complete.

B. Sex Differences

Sex differences in clinical pain prevalence and severity in humans are robust, with females greatly overrepresented as pain patients (Berkley, 1997; Unruh, 1996). In the laboratory, humans display consistent sex-related differences in pain sensitivity, with the effect size dependent on the modality of the noxious stimulus (Fillingim and Maixner, 1995; Riley et al., 1998). However, it has been difficult in rodents to consistently find these differences (Craft, 2003). One complicating factor is the well-established interaction between sex and genotype; sex differences are much larger in some strains than in others (Kest et al., 1999; Mogil, 2003). It is interesting that despite the difficulty in replicating quantitative sex differences in the laboratory, considerable evidence has amassed suggestive of *qualitative* sex differences in the genetic and neurochemical mechanisms underlying pain modulation (Liu and Gintzler, 2000; Mitrovic et al., 2003; Mogil et al., 1993, 1997b; Tershner et al., 2000), including in humans (Mogil et al., 2003).

C. Age Differences

Although a strong (and increasingly important) determinant of pain prevalence and severity in humans exist, there is a paucity of animal data studying the effect of subject age on pain sensitivity (Gagliese and Melzack, 2000), and almost no data whatsoever in the laboratory mouse. In general, the animal and human data both show a curvilinear pattern of changes, with middle-aged subjects showing higher pain levels compared to young and aged subjects (Gagliese and Melzack, 1999). Developmental changes in pain sensitivity are also a topic of considerable research (Fitzgerald, 2005; Hamm and Knisely, 1988). As a practical matter, however, the vast majority of current pain studies in mice use young-adult subjects, between 6 weeks and 4 months of age.

D. Circadian Effects

The chronobiology of pain has been studied in humans since 1912 (Grabfield and Martin, 1912). Perissin et al. (2000, 2003) report decreased sensitivity to thermal pain in rodents' dark (active) phase in the clear majority of existing studies, although rhythm \times genotype interactions have also been

reported (Castellano et al., 1985; Perissin et al., 2000). These findings are of limited relevance since the vast majority of current pain studies in mice are performed within-phase, and usually in the subjects' light (resting) phase. This may represent a major confound of animal pain research (akin to testing humans for pain immediately after waking them up out of their sleep). Alternatively, one could house and test animals on a reverse light–dark cycle. This is somewhat impractical for lab personnel, however, and may be associated with its own confounds. Unless the vivarium, laboratory, and any connecting corridors were all kept completely dark, mice would be exposed to light pulses that might cause circadian phase-shifting, which itself could alter results in chronic pain testing paradigms.

E. Experimenter Effects

A widely cited study by Crabbe et al. (1999) tested mice of various strains in three locations, with all husbandry and testing parameters controlled, and reported large interlaboratory variability on a number of behavioral tests. They concluded that idiosyncratic factors—for example, related to the experimenters themselves—were responsible for much of the observed variance. We performed a reversal of this experiment, using archived data (from 1993 to 2001) to search for intralaboratory factors affecting variability in the 49°C tail-withdrawal test (Chesler et al., 2002a, 2002b). We found specifically that the experimenter performing the test was responsible for more variance than any other single factor, for reasons that remain obscure. More recent data have illustrated that other pain tests too are greatly affected by the experimenter performing the test (Mogil et al., 2006). Striking unpublished data from our laboratory suggest that in tonic assays like the formalin and abdominal constriction test, the mere presence of a human being in the testing room is sufficient to greatly inhibit pain-related behaviors, lending support to efforts to automate procedures as much as possible.

F. Social Context Effects

The data-mining exercise described above revealed the very surprising fact that within-cage order of testing significantly affected thermal pain sensitivity, with later-tested mice showing decreased withdrawal latencies (Chesler et al., 2002a, 2002b). Although we still have no explanation for this observation, it inspired a series of studies designed to investigate whether social communication among mice housed and/or tested together could affect pain behavior. We found that mice tested on the formalin or abdominal constriction test, visually observing their conspecifics also in pain, displayed increased pain behaviors (Langford et al., 2006). Amazingly, the increase was only seen when mice were observing their cagemates; observation of strangers produced no enhancement. This phenomenon could

not be explained by stress/anxiety, and seemed consistent with the possibility that mice are capable of “emotional contagion” for pain, a form of empathy (Preston and de Waal, 2002). We found as well that male (but not female) mice tested for pain in front of an unaffected stranger would often completely inhibit their pain behaviors.

We believe that social factors can indeed affect pain sensitivity in mice and thus represent a major concern for existing animal pain studies. Our current findings suggest that testing mice where they can observe other mice being tested simultaneously is a bad idea.

V. NEW DIRECTIONS IN ANIMAL PAIN TESTING

As we have described in this chapter, advances have been and are continuing to be made in animal pain testing, both in terms of modeling pain-producing injuries and in terms of assessing pain-relevant behaviors. There is ever-more-urgent debate in the pain research community at the present time over whether the reflex withdrawal measures in such common use ought to be supplemented and even replaced by operant techniques, and whether it is worth the effort to try to quantify spontaneously emitted behaviors of animals in chronic pain models. The debate revolves around whether one believes that basic pain researchers have done a good job or a poor job of identifying molecular drug targets for analgesic development. The only clear success in this endeavor is the recent approval by the U.S. Food and Drug Administration of ziconotide (Prialt™; Elan Pharmaceuticals Inc.), a synthetic version of the *Conus magus* toxin which blocks N-type voltage-gated calcium channels, and was thus rationally designed based on the results of rodent experiments (Lyseng-Williamson and Perry, 2006). As a clinical entity, though, ziconotide has limited utility, given that it must be administered intrathecally. Besides ziconotide, the only new classes of compounds used to treat chronic pain developed since opioids, NSAIDs, and acetaminophen, are the antidepressants (McQuay et al., 1996) and the antiepileptics (Wiffen et al., 2005), but these are the result of pure serendipity. Some argue that the failure of any other molecule to make it to the clinic is a result of toxicity and poor clinical trial design, not a lack of efficacy in humans (Kontinen and Meert, 2002). Others point to high-profile failures to translate from rodent to human efficacy, for example the neurokinin-1 receptor antagonists (Hill, 2000), as illustrative of the continuing problems. For the sake of human and animal sufferers of chronic pain, we hope that the situation will improve in the near future.

REFERENCES

- Abbott, F.V., Oevirk, R., Najafee, R., and Franklin, K.B.J. (1999). Improving the efficiency of the formalin test. *Pain* **83**, 561–569.

- Aley, K.O., and Levine, J.D. (2002). Different peripheral mechanisms mediate enhanced nociception in metabolic/toxic and traumatic, painful peripheral neuropathies in the rat. *Neuroscience* **11**, 389–397.
- Arner, S., and Meyerson, B.A. (1988). Lack of analgesic effect of opioids on neuropathic and idiopathic forms of pain. *Pain* **33**, 11–23.
- Attal, N., Jazat, F., Kayser, V., and Guilbaud, G. (1990). Further evidence for 'pain-related' behaviours in a model of unilateral peripheral mononeuropathy. *Pain* **41**, 235–251.
- Authier, N., Gillet, J.P., Fialip, J., Eschalier, A., and Coudore, F. (2000). Description of a short-term Taxol-induced nociceptive neuropathy in rats. *Brain Res.* **887**, 239–249.
- Basbaum, A.I., and Fields, H.L. (1984). Endogenous pain control systems: Brainstem spinal pathways and endorphin circuitry. *Annu. Rev. Neurosci.* **7**, 309–338.
- Basbaum, A.I., and Wall, P.D. (1976). Chronic changes in the response of cells in adult cat dorsal horn following partial deafferentation: The appearance of responding cells in a previously non-responsive region. *Brain Res.* **116**, 181–204.
- Belknap, J.K., Lamé, M., and Danielson, P.W. (1990). Inbred strain differences in morphine-induced analgesia with the hot plate assay: A reassessment. *Behav. Genet.* **20**, 333–338.
- Bennett, G.J. (2006). Can we distinguish between inflammatory and neuropathic pain? *Pain Res. Manag.* **11**(Suppl. A), 11A–15A.
- Bennett, G.J., and Xie, Y.-K. (1988). A peripheral mononeuropathy in rat that produces disorders of pain sensation like those seen in man. *Pain* **33**, 87–107.
- Berkley, K.J. (1997). Sex differences in pain. *Behav. Brain Sci.* **20**, 371–380.
- Bon, K., Lichtensteiger, C.A., Wilson, S.G., and Mogil, J.S. (2003). Characterization of cyclophosphamide cystitis, a model of visceral and referred pain in the mouse: Species and strain differences. *J. Urol.* **170**, 1008–1012.
- Bove, G. (2006). Mechanical sensory threshold testing using nylon monofilaments: The pain field's "Tin Standard". *Pain* **124**, 13–17.
- Butler, S.H. (1989). Animal models and the assessment of chronic pain: Critique of the arthritic rat model. In "Issues in Pain Measurement." (C.R. Chapman and J.D. Loeser, eds.), pp 473–479. Raven Press, New York.
- Carter, R.B. (1991). Differentiating analgesic and non-analgesic drug activities on rat hot plate: Effect of behavioral endpoint. *Pain* **47**, 211–220.
- Castellano, C., Puglisi-Allegra, S., Renzi, P., and Oliverio, A. (1985). Genetic differences in daily rhythms of pain sensitivity in mice. *Pharmacol. Biochem. Behav.* **23**, 91–92.
- Caterina, M.J., Schumacher, M.A., Tominaga, M., Rosen, T.A., Levine, J.D., and Julius, D. (1997). The capsaicin receptor: A heat-activated ion channel in the pain pathway. *Nature* **389**, 816–824.
- Chaplan, S.R., Bach, F.W., Pogrel, J.W., Chung, J.M., and Yaksh, T.L. (1994). Quantitative assessment of tactile allodynia evoked by unilateral ligation of the fifth and sixth lumbar nerves in the rat. *J. Neurosci. Methods* **53**, 55–63.
- Chesler, E.J., Ritchie, J., Kokayeff, A., Lariviere, W.R., Wilson, S.G., and Mogil, J.S. (2003). Genotype-dependence of gabapentin and pregabalin sensitivity: The pharmacogenetic mediation of analgesia is specific to the type of pain being inhibited. *Pain* **106**, 325–335.
- Chesler, E.J., Wilson, S.G., Lariviere, W.R., Rodriguez-Zas, S.L., and Mogil, J.S. (2002a). Identification and ranking of genetic and laboratory environment factors influencing a behavioral trait, thermal nociception, via computational analysis of a large data archive. *Neurosci. Biobehav. Rev.* **26**, 907–923.
- Chesler, E.J., Wilson, S.G., Lariviere, W.R., Rodriguez-Zas, S.L., and Mogil, J.S. (2002b). Influences of laboratory environment on behavior. *Nat. Neurosci.* **5**, 1101–1102.
- Choi, Y., Yoon, Y.W., Na, H.S., Kim, S.H., and Chung, J.M. (1994). Behavioral signs of ongoing pain and cold allodynia in a rat model of neuropathic pain. *Pain* **59**, 369–376.
- Colpaert, F.C., Meert, T., De Witte, P., and Schmitt, P. (1982). Further evidence validating adjuvant arthritis as an experimental model of chronic pain in the rat. *Life Sci.* **31**, 67–75.
- Crabbe, J.C., Wahlsten, D., and Dudek, B.C. (1999). Genetics of mouse behavior: Interactions with laboratory environment. *Science* **284**, 1670–1672.
- Craft, R.M. (2003). Sex differences in opioid analgesia: From mouse to man. *J. Clin. Pain* **19**, 175–186.
- de Castro Costa, M., de Sutter, P., Gybels, J., and van Hees, J. (1981). Adjuvant-induced arthritis in rats: A possible animal model of chronic pain. *Pain* **10**, 173–185.
- Decosterd, I., and Woolf, C.J. (2000). Spared nerve injury: An animal model of persistent peripheral neuropathic pain. *Pain* **87**, 149–158.
- Donaldson, L.F., Seckl, J.R., and McQueen, D.S. (1993). A discrete adjuvant-induced monoarthritis in the rat—effects of adjuvant dose. *J. Neurosci. Methods* **49**, 5–10.
- Dubuisson, D., and Dennis, S.G. (1977). The formalin test: A quantitative study of the analgesic effects of morphine, meperidine, and brain stem stimulation in rats and cats. *Pain* **4**, 161–174.
- Espejo, E.F., and Mir, D. (1993). Structure of the rat's behaviour in the hot-plate test. *Behav. Brain Res.* **56**, 171–176.
- Espejo, E.F., and Mir, D. (1994). Differential effects of weekly and daily exposure to the hot plate on the rat's behavior. *Physiol. Behav.* **55**, 1157–1162.
- Fillingim, R.B., and Maixner, W. (1995). Gender differences in the responses to noxious stimuli. *Pain Forum* **4**, 209–221.
- Fitzgerald, M. (2005). The development of nociceptive circuits. *Nat. Rev. Neurosci.* **6**, 507–520.
- Flatters, S.J., and Bennett, G.J. (2006). Studies of peripheral sensory nerves in paclitaxel-induced painful peripheral neuropathy: Evidence for mitochondrial dysfunction. *Pain* **122**, 245–257.
- Gagliese, L., and Melzack, R. (1999). Age differences in the response to the formalin test in rats. *Neurobiol. Aging* **20**, 699–707.
- Gagliese, L., and Melzack, R. (2000). Age differences in nociception and pain behaviours in the rat. *Neurosci. Biobehav. Rev.* **24**, 843–854.
- Gaston-Johansson, F., and Gustafsson, M. (1990). Rheumatoid arthritis: Determination of pain characteristics of RAI and VAS in its measurement. *Pain* **41**, 35–40.
- Grabfield, G.P., and Martin, E.G. (1912). Variations in the sensory threshold for faradic stimulation in normal human subjects. I. The diurnal rhythm. *Am. J. Physiol.* **31**, 300–308.
- Haffner, F. (1929). Experimentelle prüfung schmerzstellender mittel. *Deutsch. Me. Wochenschr.* **55**, 731–733.
- Hamm, R.J., and Knisely, J.S. (1988). Developmental aspects of nociception. *Brain Res. Bull.* **21**, 933–946.
- Hammond, D.L. (1989). Inference of pain and its modulation from simple behaviors. In "Advances in Pain Research and Therapy: Issues in Pain Management." (C.R. Chapman and J.D. Loeser, eds.), pp 69–91. Raven Press, New York.
- Hargreaves, K., Dubner, R., Brown, F., Flores, C., and Joris, J. (1988). A new and sensitive method for measuring thermal nociception in cutaneous hyperalgesia. *Pain* **32**, 77–88.
- Hill, R. (2000). NK1 (substance P) receptor antagonists—why are they not analgesic in humans? *Trends Pharmacol. Sci.* **21**, 244–246.
- Irwin, S., Houde, R.W., Bennett, D.R., Hendershot, L.C., and Seevers, M.H. (1951). The effects of morphine, methadone, and meperidine on some reflex responses of spinal animals to nociceptive stimulation. *J. Pharmacol. Exp. Ther.* **101**, 132–143.
- Jabakhanji, R., Foss, J.M., Berra, H.H., Centeno, M.V., Apkarian, A.V., and Chialvo, D.R. (2006). Inflammatory and neuropathic pain animals exhibit distinct responses to innocuous thermal and motoric challenges. *Mol. Pain* **2**, 1.
- Jasmin, L., Kohan, L., Franssen, M., Janni, G., and Goff, J.R. (1998). The cold plate as a test of nociceptive behaviors: Description and application to the study of chronic neuropathic and inflammatory pain models. *Pain* **75**, 367–382.
- Kamei, J., Tamura, N., and Saitoh, A. (2005). Possible involvement of the spinal nitric oxide/cGMP pathway in vincristine-induced painful neuropathy in mice. *Pain* **117**, 112–120.

- Kest, B., Wilson, S.G., and Mogil, J.S. (1999). Sex differences in supraspinal morphine analgesia are dependent on genotype. *J. Pharmacol. Exp. Ther.* **289**, 1370–1375.
- Kim, S.H., and Chung, J.M. (1992). An experimental model for peripheral neuropathic produced by segmental spinal nerve ligation in the rat. *Pain* **50**, 355–363.
- Kontinen, V.K., and Meert, T.F. (2002). Predictive validity of neuropathic pain models in pharmacological studies with a behavioral outcome in the rat: A systematic review. In "Proceedings of the 10th World Congress on Pain." (J.O. Dostrovsky, D.B. Carr, and M. Koltzenburg, eds.), pp 489–498. IASP Press, Seattle, Washington, DC.
- Koster, R., Anderson, M., and de Beer, E.J. (1959). Acetic acid for analgesic screening. *Fed. Proc.* **18**, 412.
- Langford, D.L., Crager, S.E., Shehzad, Z., Smith, S.B., Sotocinal, S.G., Levenstadt, J.S., Chanda, M.L., Levitin, D.J., and Mogil, J.S. (2006). Social modulation of pain as evidence for empathy in mice. *Science* **312**, 1967–1970.
- Lariviere, W.R., Chesler, E.J., and Mogil, J.S. (2001). Transgenic studies of pain and analgesia: Mutation or background phenotype? *J. Pharmacol. Exp. Ther.* **297**, 467–473.
- Lariviere, W.R., and Melzack, R. (1996). The bee venom test: A new tonic-pain test. *Pain* **66**, 271–277.
- Lariviere, W.R., Wilson, S.G., Laughlin, T.M., Kokoyeff, A., West, E.E., Adhikari, S.M., Wan, Y., and Mogil, J.S. (2002). Heritability of nociception III. Genetic relationships among commonly used assays of nociception and hypersensitivity. *Pain* **97**, 75–86.
- Larson, A.A., Brown, D.R., El-Atrash, S., and Walser, M.M. (1986). Pain threshold changes in adjuvant-induced inflammation: A possible model of chronic pain in the mouse. *Pharmacol. Biochem. Behav.* **24**, 49–53.
- Le Bars, D., Gozariu, M., and Cadden, S.W. (2001). Animal models of nociception. *Pharmacol. Rev.* **53**, 597–652.
- Liu, N.-J., and Gintzler, A.R. (2000). Prolonged ovarian sex steroid treatment of male rats produces antinociception: Identification of sex-based divergent analgesic mechanisms. *Pain* **85**, 273–281.
- Lyseng-Williamson, K.A., and Perry, C. (2006). Ziconotide. *CNS Drugs* **20**, 331–338.
- Maier, S.F., Wiertelak, E.P., Goehler, L., Martin, D., and Watkins, L.R. (1993). Interleukin-1 mediates the behavioral hyperalgesia produced by lithium chloride and endotoxin. *Brain Res.* **623**, 321–325.
- Malmberg, A.B., and Basbaum, A.I. (1998). Partial sciatic nerve injury in the mouse as a model of neuropathic pain: Behavioral and neuroanatomical correlates. *Pain* **76**, 215–222.
- Martinez, V., Thakur, S., Mogil, J.S., Tache, Y., and Mayer, E.A. (1996). Differential effects of chemical and mechanical colonic irritation on behavioral pain response to intraperitoneal acetic acid in mice. *Pain* **81**, 179–186.
- McQuay, H.J., Tramer, M., Nye, B.A., Carroll, D., Wiffen, P.J., and Moore, R.A. (1996). A systematic review of antidepressants in neuropathic pain. *Pain* **68**, 217–227.
- Meller, S.T., and Gebhart, G.F. (1997). Intraplantar zymosan as a reliable, quantifiable model of thermal and mechanical hyperalgesia in the rat. *Eur. J. Pain* **1**, 43–52.
- Milne, R.J., Gamble, G.D., and Holford, N.H.G. (1989). Behavioral tolerance to morphine analgesia is supraspinally mediated: A quantitative analysis of dose-response relationships. *Brain Res.* **491**, 316–327.
- Mitrovic, I., Margeta-Mitrovic, M., Bader, S., Stoffel, M., Jan, L.Y., and Basbaum, A.I. (2003). Contribution of GIRK2-mediated postsynaptic signaling to opiate and α_2 -adrenergic analgesia and analgesic sex differences. *Proc. Natl. Acad. Sci. U.S.A.* **100**, 271–276.
- Mogil, J.S. (2003). Interaction between sex and genotype in the mediation of pain and pain inhibition. *Semin. Pain Med.* **1**, 197–205.
- Mogil, J.S., Chesler, E.J., Wilson, S.G., Juraska, J.M., and Sternberg, W.F. (2000). Sex differences in thermal nociception and morphine antinociception in rodents depend on genotype. *Neurosci. Biobehav. Rev.* **24**, 375–389.
- Mogil, J.S., and Crager, S.E. (2004). What should we be measuring in behavioral studies of chronic pain in animals? *Pain* **112**, 12–15.
- Mogil, J.S., and Grisel, J.E. (1998). Transgenic studies of pain. *Pain* **77**, 107–128.
- Mogil, J.S., Meirmeister, F., Seifert, F., Strasburg, K., Zimmermann, K., Reinold, H., Austin, J.-S., Bernardini, N., Chesler, E.J., Hoffman, H.A., Hordo, C., Messlinger, K., Nemmani, K.V.S., Rankin, A.L., Ritchie, J., Siegling, A., Smith, S.B., Sotocinal, S.B., Vater, A., Lehto, S.G., Klussmann, S., Quirion, R., Michaelis, M., Devor, M., and Reeh, P.W. (2005). Variable sensitivity to noxious heat is mediated by differential expression of the CGRP gene. *Proc. Natl. Acad. Sci. U.S.A.* **102**, 12938–12943.
- Mogil, J.S., Richards, S.P., O'Toole, L.A., Helms, M.L., Mitchell, S.R., and Belknap, J.K. (1997a). Genetic sensitivity to hot-plate nociception in DBA/2J and C57BL/6J inbred mouse strains: Possible sex-specific mediation by δ_2 -opioid receptors. *Pain* **70**, 267–277.
- Mogil, J.S., Richards, S.P., O'Toole, L.A., Helms, M.L., Mitchell, S.R., Kest, B., and Belknap, J.K. (1997b). Identification of a sex-specific quantitative trait locus mediating nonopioid stress-induced analgesia in female mice. *J. Neurosci.* **17**, 7995–8002.
- Mogil, J.S., Ritchie, J., Sotocinal, S.G., Smith, S.B., Croteau, S., Levitin, D.J., and Naumova, A.K. (2006). Screening for pain phenotypes: Analysis of three congenic mouse strains on a battery of nine nociceptive assays. *Pain* **126**, 24–34.
- Mogil, J.S., Sternberg, W.F., Kest, B., Marek, P., and Liebeskind, J.C. (1993). Sex differences in the antagonism of swim stress-induced analgesia: Effects of gonadectomy and estrogen replacement. *Pain* **53**, 17–25.
- Mogil, J.S., Wilson, S.G., Bon, K., Lee, S.E., Chung, K., Raber, P., Pieper, J.O., Hain, H.S., Belknap, J.K., Hubert, L., Elmer, G.I., Chung, J.M., and Devor, M. (1999a). Heritability of nociception. I. Responses of eleven inbred mouse strains on twelve measures of nociception. *Pain* **80**, 67–82.
- Mogil, J.S., Wilson, S.G., Bon, K., Lee, S.E., Chung, K., Raber, P., Pieper, J.O., Hain, H.S., Belknap, J.K., Hubert, L., Elmer, G.I., Chung, J.M., and Devor, M. (1999b). Heritability of nociception. II. "Types" of nociception revealed by genetic correlation analysis. *Pain* **80**, 83–93.
- Mogil, J.S., Wilson, S.G., Chesler, E.J., Rankin, A.L., Nemmani, K.V.S., Lariviere, W.R., Groce, M.K., Wallace, M.R., Kaplan, L., Staud, R., Ness, T.J., Glover, T.L., Stankova, M., Mayorov, A., Hruby, V.J., Grisel, J.E., and Fillingim, R.B. (2003). The melanocortin-1 receptor gene mediates female-specific mechanisms of analgesia in mice and humans. *Proc. Natl. Acad. Sci. U.S.A.* **100**, 4867–4872.
- Mogil, J.S., Wilson, S.G., and Wan, Y. (2001). Assessing nociception in murine subjects. In "Methods in Pain Research." (L. Kruger, ed.), pp 11–39. CRC Press, Boca Raton, FL.
- Ness, T.J., and Gebhart, G.F. (1988). Colorectal distention as a noxious visceral stimulus: Physiologic and pharmacologic characterization of pseudoaffective responses in the rat. *Brain Res.* **450**, 153–169.
- Ness, T.J., and Gebhart, G.F. (1990). Visceral pain: A review of experimental studies. *Pain* **41**, 167–234.
- Neubert, J.K., Rossi, H.L., Malphurs, W., Vierck, C.J., Jr., and Caudle, R.M. (2006). Differentiation between capsaicin-induced allodynia and hyperalgesia using a thermal operant assay. *Behav. Brain Res.* **170**, 308–315.
- Nozaki-Taguchi, N., Chaplan, S.R., Higuera, E.S., Ajakwe, R.C., and Yaksh, T.L. (2001). Vincristine-induced allodynia in the rat. *Pain* **93**, 69–76.
- Olivar, T., and Laird, J.M.A. (1999). Cyclophosphamide cystitis in mice: Behavioral characterization and correlation with bladder inflammation. *Eur. J. Pain* **3**, 141–149.
- Pearson, C.M. (1956). Development of arthritis, peri-arthritis, and periostosis in rats given Freund's adjuvant. *Proc. Soc. Exp. Biol. Med.* **91**, 95–101.
- Perissin, L., Facchin, P., and Porro, C.A. (2000). Diurnal variations in tonic pain reactions in mice. *Life Sci.* **67**, 1477–1488.
- Perissin, L., Facchin, P., and Porro, C.A. (2003). Tonic pain response in mice: Effects of sex, season, and time of day. *Life Sci.* **72**, 897–907.
- Pircio, A.W., Fedele, C.T., and Bierwagen, M.E. (1975). A new method for the evaluation of analgesic activity using adjuvant-induced arthritis in the rat. *Eur. J. Pharmacol.* **31**, 207–215.

- Pitcher, G.M., Ritchie, J., and Henry, J.L. (1999). Paw withdrawal threshold in the von Frey hair test is influenced by the surface on which the rat stands. *J. Neurosci. Methods* **87**, 185–193.
- Pizziketti, R.J., Pressman, N.S., Geller, E.B., Cowan, A., and Adler, M.W. (1985). Rat cold water tail-flick: A novel analgesic test that distinguishes opioid agonists from mixed agonist-antagonists. *Eur. J. Pharmacol.* **119**, 23–29.
- Plone, M.A., Emerich, D.F., and Lindner, M.D. (1996). Individual differences in the hot-plate test and effects of habituation on sensitivity to morphine. *Pain* **66**, 265–270.
- Polomano, R.C., Mannes, A.J., Clark, U.S., and Bennett, G.J. (2001). A painful peripheral neuropathy in the rat produced by the chemotherapeutic drug, paclitaxel. *Pain* **94**, 293–304.
- Porro, C.A., and Carli, G. (1988). Immobilization and restraint effects on pain reactions in animals. *Pain* **32**, 289–307.
- Porro, C.A., and Cavazzuti, M. (1993). Spatial and temporal aspects of spinal cord and brainstem activation in the formalin pain model. *Prog. Neurobiol.* **41**, 565–607.
- Preston, S.D., and de Waal, F.B.M. (2002). Empathy: Its ultimate and proximate bases. *Behav. Brain Sci.* **25**, 1–72.
- Randall, L.O., and Selitto, J.J. (1957). A method for measurement of analgesic activity on inflamed tissue. *Arch. Int. Pharmacodyn.* **111**, 409–419.
- Riley, J.L. III, Robinson, M.E., Wise, E.A., Myers, C.D., and Fillingim, R.B. (1998). Sex differences in the perception of noxious experimental stimuli: A meta-analysis. *Pain* **74**, 181–187.
- Seltzer, Z., Dubner, R., and Shir, Y. (1990). A novel behavioral model of causalgiform pain produced by partial sciatic nerve injury in rats. *Pain* **43**, 205–218.
- Seltzer, Z., Wu, T., Max, M.B., and Diehl, S.R. (2001). Mapping a gene for neuropathic pain-related behavior following peripheral neurectomy in the mouse. *Pain* **93**, 101–106.
- Siau, C., and Bennett, G.J. (2006). Dysregulation of cellular calcium homeostasis in chemotherapy-evoked painful peripheral neuropathy. *Anesth. Analg.* **102**, 1485–1490.
- Siau, C., Xiao, W., and Bennett, G.J. (2006). Paclitaxel- and vincristine-evoked painful peripheral neuropathies: Loss of epidermal innervation and activation of Langerhans cells. *Exp. Neurol.* **201**, 507–514.
- Siegmund, E., Cadmus, R., and Lu, G. (1957). A method for evaluating both non-narcotic and narcotic analgesics. *Proc. Soc. Exp. Biol. Med.* **95**, 729–731.
- Sluka, K.A., Kalra, A., and Moore, S.A. (2001). Unilateral intramuscular injections of acidic saline produce a bilateral, long-lasting hyperalgesia. *Muscle Nerve* **24**, 37–46.
- Smith, S.B., Crager, S.E., and Mogil, J.S. (2004). Paclitaxel-induced neuropathic hypersensitivity in mice: Responses in 10 inbred mouse strains. *Life Sci.* **74**, 2593–2604.
- Stein, C., Millan, M.J., and Herz, A. (1988). Unilateral inflammation of the hindpaw in rats as a model of prolonged noxious stimulation: Alterations in behavior and nociceptive thresholds. *Pharmacol. Biochem. Behav.* **31**, 455–451.
- Sufka, K.J., Watson, G.S., Nothdurft, R.E., and Mogil, J.S. (1998). Scoring the mouse formalin test: A validation study. *Eur. J. Pain* **2**, 351–358.
- Taber, R.I. (1974). Predictive value of analgesic assays in mice and rats. *Adv. Biochem. Psychopharmacol.* **8**, 191–211.
- Takagi, H., Inukai, T., and Nakama, M. (1966). A modification of Haffner's method for testing analgesics. *Jpn. J. Pharmacol.* **16**, 287–294.
- Tanner, K.D., Reichling, D.B., and Levine, J.D. (1998). Nociceptor hyper-responsiveness during vincristine-induced painful peripheral neuropathic in rat. *J. Neurosci.* **18**, 6480–6491.
- Tershner, S.A., Mitchell, J.M., and Fields, H.L. (2000). Brainstem pain modulating circuitry is sexually dimorphic with respect to mu and kappa opioid receptor function. *Pain* **85**, 153–159.
- Tjolsen, A., Berge, O.-G., Hunskaar, S., Rosland, J.H., and Hole, K. (1992). The formalin test: An evaluation of the method. *Pain* **51**, 5–17.
- Tjolsen, A., and Hole, K. (1993). The tail-flick latency is influenced by skin temperature. *APS J.* **2**, 107–111.
- Unruh, A.M. (1996). Gender variations in clinical pain experience. *Pain* **65**, 123–167.
- van der Wende, C., and Margolin, S. (1956). Analgesic tests based upon experimentally induced acute abdominal pain in rats. *Fed. Proc.* **15**, 494.
- Vierck, C.J., Jr., Kline, R., IV, and Wiley, R.G. (2004). Comparison of operant escape and innate reflex responses to nociceptive skin temperatures produced by heat and cold stimulation of rats. *Behav. Neurosci.* **118**, 627–635.
- von Frey, M. (1922). Verspatete Schmerzempfindungen. *Z. Gesamte Neurol. Psychiatr.* **79**, 324–333.
- Wall, P.D., Devor, M., Inbal, R., Scadding, J.W., Schonfeld, D., Seltzer, Z., and Tomkiewicz, M.M. (1979). Autotomy following peripheral nerve lesions: Experimental anesthesia dolorosa. *Pain* **7**, 103–113.
- Weng, H.R., Cordella, J.V., and Dougherty, P.M. (2003). Changes in sensory processing in the spinal dorsal horn accompany vincristine-induced hyperalgesia and allodynia. *Pain* **103**, 131–138.
- Wiffen, P., Collins, S., McQuay, H., Carroll, D., Jadad, A., and Moore, A. (2005). Anticonvulsant drugs for acute and chronic pain. *Cochrane Database Syst. Rev.* CD00133.
- Winter, C.A., Risley, E.A., and Nuss, G.W. (1962). Carrageenin-induced edema in hind paw of the rat as an assay for anti-inflammatory drugs. *Proc. Soc. Exp. Biol. Med.* **111**, 544–547.

Ethical Issues in Anesthesia and Analgesia in Laboratory Animals

Larry Carbone and Nelson Garnett

I. Introduction	561
A. Descriptive Ethics: The Societal Consensus	562
B. Official Ethics: Professional Codes	562
C. Regulatory Ethics: The Ethical Basis of Regulation in the United States	562
D. Normative Ethics: Making Ethical Choices	563
II. Ethical Issues in Laboratory Animal Anesthesia, Analgesia, and Pain Management	564
A. Withholding Pain Management to Prevent Animal Injury	564
B. Withholding Pain Management for Research Needs	564
C. Reporting Pain and Distress in USDA Categories	564
D. Distress	565
E. Killing Animals	565
F. Fewer Animals/More Pain per Animal or More Animals/Less Pain per Animal?	566
G. IACUCs, Veterinarians, and the Standard of Care	567
Additional Reading	567
References	567

I. INTRODUCTION

Ethics is the inquiry of good and bad, right and wrong. The fundamental ethical question in laboratory animal care is “How should we treat the animals in laboratories?” When is it permissible to use animals at all in laboratories, or to use them in ways that may hurt or harm them? What research projects can justify putting animals in harm’s way? How much must we spend in time, labor, money, or limits on scientific inquiry to minimize their pain and distress? If animal experimentation never

harmed animals, or if animal pain management never conflicted with science, there might be no need for this chapter.

The authors believe that the prime ethical concern in laboratory animal welfare is what animals consciously experience: their pain, distress, fear, boredom, happiness, and psychological well-being. They further believe that regardless of the ethical frameworks under which one operates, most of the ethical work of Institutional Animal Care and Use Committees (IACUCs), scientists and veterinarians require some sort of weighing of costs and benefits, usually the benefits to human

society against the costs in animal welfare. Such cost–benefit analysis requires both clarification of competing values and the best possible scientific knowledge of animal pain, distress, and pain management.

In this chapter, we loosely follow Tannenbaum’s classification, and present (a) descriptive ethics, (b) official ethics, (c) administrative/regulatory ethics, and (d) normative ethics (Tannenbaum, 1995). It is important for veterinarians to know the societal context in which their work is done, to know the standards of their professional associations, and to know the codification of these ethical standards in law. Normative ethics, as Tannenbaum points out, the attempt to discover correct moral or ethical standards, is paramount: “Most veterinarians are interested in ethics because they want to determine how they really should behave, and not just how their fellow professionals, official rules, or governmental bodies say they should” (Tannenbaum, 1995, p 17).

A. Descriptive Ethics: The Societal Consensus

The American public differ in their concern for laboratory animals, from a strongly abolitionist position that would ban animal research to a completely laissez-faire attitude; many are in “the troubled middle,” uneasily accepting the use of animals in some research (Donnelly, 1990). Public opinion polls find that the acceptability of animal-based research requires the effective relief of animal pain. While use of animals in research may be justified, pain and distress must be minimized to the extent possible. Survey respondents, depending on the particular questions asked, will support the use of animals in laboratories, though that support wanes when there are species of high concern involved, or if there is anticipated pain, distress, or suffering (Foundation for Biomedical Research, 2005; Humane Society of the United States, 2001; Plous, 1998; The Gallup Organization, 2007).

B. Official Ethics: Professional Codes

The ethical statements of numerous scientific and veterinary societies reflect this societal consensus: that pain and distress must be minimized if animal-based research is to be ethically acceptable. The position statement of American College of Laboratory Animal Medicine (ACLAM) on pain and distress in laboratory animals starts with its ethical position: “Procedures expected to cause more than slight or momentary pain (e.g., pain in excess of a needle prick or injection) require the appropriate use of pain-relieving measures unless scientifically justified in an approved animal care and use protocol” (ACLAM, 2001). Readers are referred as well to the position statements of American Association for Laboratory Animal Science (AALAS), The Federation of American Societies for Experimental Biology (FASEB), and National Aeronautics and Space Administration (NASA) (AALAS, 2003; FASEB, 2007; NASA, 1996).

Numerous scientific journals now require verification that authors have met ethical standards in their animal care and use.

Veterinarians have a special role in the laboratory animal pain management. The American Veterinary Medical Association holds that “Veterinarians should first consider the needs of the patient: to relieve disease, suffering, or disability while minimizing pain or fear” (American Veterinary Medical Association, 2007a) (p 37).

Veterinarians are expected to have a high commitment to animal health and welfare, as well as have unique advanced training to competently fulfill this commitment. The Veterinary Oath calls on veterinarians to chart an ethical course between helping animals and helping society (as in biomedical research):

Being admitted to the profession of veterinary medicine, I solemnly swear to use my scientific knowledge and skills for the benefit of society through the protection of animal health, the relief of animal suffering, the conservation of animal resources, the promotion of public health, and the advancement of medical knowledge. (American Veterinary Medical Association, 2003)

Laboratory animal veterinarians’ pledge to relieve animal suffering while promoting public health and advancing medical knowledge entails a moral duty to advocate and provide appropriate anesthesia and analgesia to research animals. This oath complements the application of the “Three Rs” (replacement, reduction, and refinement) and the consideration of alternatives, especially refinement alternatives (Russell and Burch, 1959). Clearly, veterinarians have a professional ethical duty to stay current on the best information on animal pain management.

The authors believe that the ethical practice of laboratory animal medicine requires both a commitment to animal welfare and expert knowledge in the recognition, prevention, and treatment of animal pain. Mandatory involvement of veterinarians in institutional programs of animal care and use is an important component of most countries’ animal welfare oversight. This goes beyond the traditional role of veterinarians in clinical care to include direct roles in animal program management, protocol review, and consultation with principal investigators on the selection and use of anesthetics and analgesics during the design of potentially painful experiments. This regulatory prescription appears to presume that the involvement of the veterinarians will provide a certain level of public confidence—consistent with the generally positive public perception of veterinarians—that animals in research will be well cared for (American Veterinary Medical Association, 2007b).

C. Regulatory Ethics: The Ethical Basis of Regulation in the United States

The regulations of laboratory animal pain management are important both as a reflection of ethical thinking and as the way they shape daily practice. The original 1966 Laboratory Animal Welfare Act (LAWA) (United States Congress, 1966) focused primarily on animal acquisition, transportation, sale, and proper

care prior to use in research. However, subsequent changes in the law and implementing regulations have gradually shifted the focus to include major provisions aimed at avoidance or alleviation of pain and distress (Carbone, 2004).

The U.S. Government Principles for the Utilization and Care of Vertebrate Animals Used in Testing, Research, and Training (United States Interagency Research Animal Committee, 1985) reflect the societal values that form the ethical underpinnings of the entire U.S. system of animal welfare oversight, including the Animal Welfare Act (AWA), and are explicitly referenced in the “Public Health Service Policy on Humane Care and Use of Laboratory Animals” (Office of Protection from Research Risks, 1986). The principles most applicable to the issues of anesthesia and analgesia are as follows:

IV. Proper use of animals, including the avoidance or minimization of discomfort, distress, and pain when consistent with sound scientific practices, is imperative. Unless the contrary is established, investigators should consider that procedures that cause pain or distress in human beings may cause pain or distress in other animals.

V. Procedures with animals that may cause more than momentary or slight pain or distress should be performed with appropriate sedation, analgesia, or anesthesia. Surgical or other painful procedures should not be performed on unanesthetized animals paralyzed by chemical agents.

VI. Animals that would otherwise suffer severe or chronic pain or distress that cannot be relieved should be painlessly killed at the end of the procedure or, if appropriate, during the procedure.

Public Health Service (PHS) Policy language describing required information that must be included in PHS grant applications as well as criteria for protocol review by IACUCs, follow the language from the U.S. Government Principles closely. Much of this PHS Policy language was, in turn, adopted verbatim into the current the United States Department of Agriculture (USDA) regulations during their promulgation. The consistency of the various federal regulations and policies is due to the fact that they can all be traced back to the single ethical framework outlined in the U.S. Government Principles.

In 1970, the Congress amended the AWA, specifying “adequate veterinary care,” including pain management under direction of the attending veterinarian (unless not allowed by research needs) (91st Congress, 1970). The 1985 AWA amendment focused heavily on animal pain, and established the Animal Welfare Information Center (AWIC), the purpose of which is to “provide information on improved methods of animal experimentation, including methods which could . . . minimize pain and distress to animals, such as anesthetic and analgesic procedures” (United States Congress, 1985). The 1985 AWA amendment also mandated the role of IACUCs with their role in oversight of efforts to minimize pain and distress.

The ethical theory behind the regulatory mandates is not well articulated except in terms of general public concern. The Congress’ introductory language to the 1985 AWA framed this as but an indirect duty to animals, finding that “measures which help meet the public concern for laboratory animal care and

treatment are important in assuring that research will continue to progress” (United States Congress, 1985).

D. Normative Ethics: Making Ethical Choices

In 1996, NASA’s “Sundowner Principles” articulated three societal principles for the ethical evaluation of animal experimentation: respect for life, societal benefit, and *nonmaleficence*. The principle of *nonmaleficence* means that minimization of distress, pain, and suffering is a moral imperative. *Respect for life* means that causing harm to animals requires justification, while concern for *societal benefit* means that animal research can indeed be justified, if it benefits society. A majority of philosophers converge on the idea that there is no good criterion by which we would exclude nonhumans from these principles, for those animals capable of perceiving noxious stimuli in a way that truly harms them. By contrast, Beauchamp and Childress’ principle of respect for autonomy has less of a place in animal research, as most animals (with the possible exception of great apes, some cetaceans, and possibly some other taxa) appear to lack the degree of self-awareness to be capable of true autonomy (Beauchamp and Childress, 1994).

Animal research is a public and often a publicly funded activity. Because of this, research scientists and veterinarians have an ethical responsibility directly to society (and indirectly to the animals) to respect broad concerns about animal welfare. The authors believe that the principle of nonmaleficence further creates a direct duty to the animals themselves, to take their welfare seriously and to minimize the harmful impact of research procedures on them.

The philosopher David DeGrazia has described a “hedonistic subjectivist” animal ethic (DeGrazia, 1996). That is to say that the moral issues in working with animals revolve largely around how animals feel (i.e., it is hedonistic), and more precisely, how they themselves perceive their own condition (i.e., it is subjective, though limited to the extent that we can divine animal subjects’ minds). DeGrazia’s theory is not exclusively focused on the animal’s subjective feelings, recognizing that it may be the most ethical course to restrain and hurt animals in the short term, such as in performing veterinary care for their long-term health. The ethical concern is not for activation of nociceptive pathways per se, but for the experiential (conscious, emotional) perception of pain (and therefore, sense of suffering) that can accompany nociceptive input. For the purposes of this anesthesia and analgesia text, this means that IACUCs, scientists, and veterinarians must seriously evaluate what the animal may consciously perceive as pain, whether from procedures or illnesses, as well as the ability to control that pain. In addition, the IACUC must consider the distress caused by pain, and even the distress associated with anesthetic induction and recovery.

Putting all of this together, nonmaleficence and respect for life impose a direct duty to take animals’ subjective states (pleasure, pain, etc.) seriously, while societal benefit allows

scientists occasionally to override animal welfare for important research. The most challenging ethical decisions are those in which potential goods (such as science and animal welfare, or refinements and reduction of numbers) or potential harms (such as pain and death) must be weighed against each other. Specific issues and exemplar cases follow.

II. ETHICAL ISSUES IN LABORATORY ANIMAL ANESTHESIA, ANALGESIA, AND PAIN MANAGEMENT

A. Withholding Pain Management to Prevent Animal Injury

The belief that masking pain might actually be detrimental to an animal's well-being was prevalent in veterinary schools years ago, and was not uncommonly held among practicing veterinarians (American College of Veterinary Anesthesiologists, 1998). This belief predates the availability of modern analgesics, and may have been a rationalization for the lack of effective pain medications. There is an evolutionary advantage for animals to develop self-protective behaviors in response to pain, and so an animal would refrain from reinjuring a pinned bone (for example) only if pain prohibited exuberant use of the limb. If current data supported this reasoning, this would be one situation where the animal's subjective state of well-being might be overruled in the interest of longer-term health, where allowing the harm of pain prevents the greater harm of serious injury. This contraindication of analgesics would raise the ethical cost of all surgical procedures in research, even though withholding analgesia was for the animals' health.

The effects of analgesia on healing are complex. In laboratory studies, some nonsteroidal anti-inflammatory drugs (NSAIDs) delay bone healing, while opioids and some other NSAIDs may not, though there may not be a strong enough clinical effect to shape practice (Brown et al., 2004; Clarke and Lecky, 2005). In human patients, numbing a limb can lead to overuse and injury (Edwards et al., 2006). In other models, pain management and analgesic treatment speed healing (Hanson et al., 2005). Despite the complexity, it appears there is neither scientific nor ethical justification for withholding all analgesia from laboratory animals, and a thorough search for current information is essential. For surgical models, analgesic therapy can be supplemented with nursing care, including proper stabilization of fractures, surgical wound management, modifications to nutrition, fluid therapy, etc., often without compromising the research protocol.

B. Withholding Pain Management for Research Needs

In the American regulatory setting, IACUCs may permit withholding pain management when that is scientifically

justified. Examples include studies of pain mechanisms, studies of inflammatory processes, some toxicity testing, and other situations where at the very least an untreated control group may be scientifically necessary. The IACUC must review the investigator's fact-finding and literature searches to verify that pain medications truly might invalidate the data (and correlatively, that pain itself in one cohort of animals is not an experimental variable that must be minimized). Such studies are reported in Column E of the USDA annual report, and are frequently referred to, even for USDA-excluded species, as "Category E" studies (Karas and Silverman, 2007).

Because there is no explicit prohibition against doing such Category E research, the challenge for researchers and IACUCs is not just the factual question of whether anesthesia or analgesia would invalidate the study, but also the ethical judgment whether the potential benefits of the study outweigh the unrelieved pain or distress.

This cost-benefit assessment is necessary not just for Category E studies, but for all animal research, and raises the question of how much the IACUC reviews scientific merit. U.S. Government Principle II states: "Procedures involving animals should be designed and performed with due consideration of their relevance to human or animal health, the advancement of knowledge, or the good of society." The authors maintain that it is impossible for IACUCs to satisfy the federally mandated review criteria without weighing the ethical cost/benefit ratio in studies of this nature. Meritorious research is both important research and research that is designed in a way likely to produce valid scientific data (Prentice et al., 1992). The IACUC may meet this commitment, at least in part, by verifying that a peer review process has found the work to be meritorious.

C. Reporting Pain and Distress in USDA Categories

The AWA regulations require research institutions to report their animal use in several categories. Many American institutions use these categories in-house even for species not reported to the USDA. The reporting categories were introduced in 1971 to address the public concern that scientists performed painful surgeries and other procedures without anesthesia and pain management. Category E studies are those in which some degree of pain or distress are anticipated for the animal subjects, but in which at least some of that must be left untreated, so as not to invalidate the study. In Category D studies, potentially painful procedures are managed with painkillers. Mixed studies are reported in the higher category—for example, using anesthetics and analgesics for surgically placing an intrathecal cannula would result in a Category D report, unless the cannula were used to infuse inflammatory substances for a chronic pain study. This study would then be moved into Category E (USDA, 1977).

This pain categorization is not mere semantics or bureaucracy, but has real implications for how animals are treated. The authors have noted that researchers actively avoid having their

studies placed in Category E, even for those species not publicly reported to the USDA. There is some sort of internal ethical or social pressure to avoid being identified as someone who causes unrelieved pain to animals. This is good when it encourages scientists to seek out earlier end points, more aggressive pain management, and less invasive procedures. This is not good in cases where it merely results in underreporting Category E studies, or worse, when pain management is withheld out of insistence that the procedure is not as painful as it truly might be.

One challenge for IACUCs is temporal: If pain is treated only once it has reached a certain evident level, does the undetected pain leading up to that point place a study in Category E? Or, does the fact that the pain was eventually treated (possibly by euthanasia) keep such a project in Category D? The problem lies in the USDA's system, acknowledging the two extremes where all potential pain is treated (Category D) or where absolutely no pain is treated (Category E), but not really recognizing the multitude of animals that experience something somewhere in the middle.

Consider an inflammation study in which the investigator sets a humane end point, planning to euthanize animals with a sustained fever of 48 hours. Does this intervention—euthanasia once illness is unequivocally established—keep these animals in the lower category? Or, does the illness leading up to the established end point warrant Category E classification? Overuse of Category E classification could rob that designation of the power it has to encourage refinement of experiments. Underuse of Category E classification deprives the affected animals of that impetus to better refine the project.

The authors fear that the relatively low number of Category E animals reported annually lies in part in IACUCs' decisions to finesse the thresholds that might make a study Category E. An IACUC might decide that 48 hours of fever does not reach the Category E threshold, but that never addressing an animal's fever, no matter how long it rages, certainly does cross that threshold. Certainly, 48 hours is more than the AWA's "momentary" threshold of "slight or momentary pain or distress," but does it cross the "slight" threshold? If yes, then that animal must be reported in Category E. If all animals that experienced some significant pain for some time were to be reported in Category E, the numbers would surely shift but the categorization would lose much of its impact.

Note too that the USDA annual report is a retrospective report, not of what the IACUC approved, but of what the animals experienced, over the prior year. To honestly file an accurate report, the institution must have sufficient ongoing monitoring of approved protocols to know whether pain categorization needs to be adjusted.

D. Distress

Nonmaleficent concern for animal welfare entails not just a concern for animal pain, but for animal distress as well. The

Animal Welfare Act regulations (AWR) contain a threshold level of pain (more than slight or momentary, with the exemplar of a simple injection) that requires special pain categorization of the animals (APHIS, 1989). Distress has accompanied pain in the animal welfare regulations since the 1970 AWA amendment (Animal and Plant Health Service, 1971). The USDA has published comparable threshold exemplars for distress, such as food or water deprivation "beyond that necessary for normal presurgical preparation" (USDA, 1997). Other sources of distress include restraint, fear, nausea, depression, and the distress associated with fear (Brown et al., 2006).

Not only is distress harder than pain to define and recognize, but it is also less amenable to medical treatment. Analgesics do not help with fear or anxiety, though sedatives might. None of these drugs are likely to alleviate hunger or thirst. Thus, to the extent that animal husbandry and research practices might exceed the distress threshold that moves them out of Category C, few would get effective drug treatments that would put them in Category D. If that is the case, then the authors fear that Category E distress would be significantly underrecognized and underreported, with potential deleterious outcomes for animals. It is therefore incumbent on IACUCs to standardize the threshold of distress for various types and sources of distress.

E. Killing Animals

Most laboratory animal welfare concerns center around pain and distress. Where does killing animals fit into this? Is euthanasia a harm to a healthy animal if done painlessly and without causing fear? Does animal euthanasia require moral justification?

Animal ethicists have differed on this question. If animals have low levels of consciousness and self-consciousness, and are not really capable of planning a future or envisioning a self that continues through time, if they live only in the present, then perhaps ending their lives is not truly a harm to them (Cigman, 1989). Others argue that killing a healthy animal still deprives that animal of the future good things that life can bring, and so does constitute a harm, albeit a weaker harm than killing a more highly conscious being (DeGrazia, 1996). That is, the animal does not have to know what you are depriving him/her of for that deprivation to be a harm to him/her. Not all vertebrate animals are equal in their degree of self-consciousness. While the authors believe it does constitute a harm to kill a relatively non-self-aware mouse, dog, or monkey, great apes and some cetaceans may be sufficiently self-aware that their deaths are an even greater harm to them (DeGrazia, 1998; Kraus, 1998; NASA, 1996; Regan, 1983).

Animal euthanasia is explicitly mentioned in regulation in two contexts, both dealing with pain, distress, and pain management. The *Guide for the Care and Use of Laboratory Animals* calls for euthanasia that kills animals by inducing "rapid unconsciousness and death without pain or distress" (p 65) (Institute

of Laboratory Animal Resources, 1996). Thus, the same concerns for minimizing pain apply to the act of euthanasia as apply to the acts of surgery or other manipulations. Killing per se is not the issue; pain and distress are.

The other regulatory context for killing is that of euthanasia as the ultimate analgesic. Principle VI of the U.S. Government Principles states: "Animals that would otherwise suffer severe or chronic pain or distress that cannot be relieved should be painlessly killed at the end of the procedure or, if appropriate, during the procedure" (United States Interagency Research Animal Committee, 1985). The *Guide* and the AWA echo this statement.

In public policy, a painless death is not explicitly named as a significant harm to animals. Nonetheless, IACUCs do and should closely consider the second "R"—reduction—even when reviewing animal use protocols that include killing animals with no pain or distress imposed. If animal death were truly ethically neutral, there would never be reason to question the number of animals euthanized. To illustrate this, consider an IACUC reviewing two protocols. Investigator A wants to observe several thousand birds through binoculars as they migrate to their breeding grounds. Investigator B wants to painlessly kill two dozen birds to collect tissues. Of the two, who is more likely to be pushed to consider the second "R," reduction, the one with thousands of subjects or the one with dozens? If killing animals were a zero-cost procedure, then even thousands of animals killed should raise no ethical concern. Killing may have a lower ethical cost than severe, untreated pain, but it is not zero.

IACUCs must weigh pain against killing. If death were always preferable to any degree of animal pain, then that would preclude some activities we think of as being done for the animals' benefit (as opposed to being required for the science). Examples of this would be surgically removing a monkey's implants so that he or she can be placed in a sanctuary, or spaying or neutering a retired research dog or cat for placement as a household pet.

F. Fewer Animals/More Pain per Animal or More Animals/Less Pain per Animal?

IACUCs face an additional ethical dilemma: how to balance the principle of reduction of animal numbers used against the principle of reducing the amount of pain or distress experienced by an individual animal. The question arises: how many procedures per animal is it ethical to perform? In this section, we focus more on the harms of pain and distress, rather than the harms of killing. We assume that even those survival surgeries conducted with full anesthesia and analgesia will cause some degree of pain and distress to the animals.

The pain of multiple procedures may be additive, but often the calculus is less simple. In some cases, multiple procedures may lead to qualitatively more severe animal pain or distress. For example, bilateral procedures on the same animal may have a sparing effect on animal numbers, but these procedures may

subject the same animal to more than doubled pain or distress. Bilateral ocular procedures may allow an animal to serve as its own control but may also cause blindness. There are not just double procedures, but a qualitatively impaired state, as blindness will affect many sight-dependent animals far more than monocular visual deprivation would. Similarly, bilateral orthopedic procedures do not just double the number of surgeries compared to unilateral procedures, but force the painful use of an operated extremity, without a healthy unoperated leg to support the other. Bilateral procedures may be a necessary component of the research design; however, IACUCs must guard against rationalizations that are based on cost or convenience.

Multiple survival procedures have received special caution in public policy since the 1978 *Guide*, and are now part of the AWR as well (Institute of Laboratory Animal Resources, 1978). Sometimes, sequential procedures are required to achieve research aims. An example might be the surgical creation of a heart failure model followed weeks later by surgical repair; both must be done on the same subject for the study to be meaningful. Regulatory policy clearly allows for multiple surgeries in cases like this.

Another justification for multiple surgeries might be when a long-term or difficult preparation fails prematurely. At that point, the choice may be between an additional survival surgery to salvage the failed preparation versus euthanasia of the animal involved. To kill the animal means wasting all of the prior expense, effort, surgical pain, and the animal's life. To achieve the research aims, an additional animal would likely be used to replace the data from the one lost.

At the other extreme, regulatory policy clearly discourages cycling an animal from an invasive craniotomy project (for example) to an invasive and completely unrelated laparotomy project. While some may argue that the greater harm is to waste the animal, there is a clear bias in policy and regulation in favor of increasing the number of animals versus performing more surgeries per animal. The AWA regulations prohibit multiple survival surgeries with three possible exceptions: (a) necessary components of the same experimental design, (b) directions from the attending veterinarian for clinical veterinary reasons, or (c) prior approval from the administrator of Animal and Plant Inspection Service (APHIS). The *Guide* adds a fourth: conservation of valuable or scarce resources. However, it is clear that this is not a rationale that would comply with USDA regulation unless approved in advance by the APHIS Administrator.

Neither the *Guide* nor the AWA states precisely why multiple survival surgeries are to be avoided, nor is this prohibition extended to other sources of pain (not even to Category E studies). There are cases where the harm of survival surgeries is multiplicative rather than merely additive, for example, when prior abdominal surgeries have sensitized visceral nociceptors and caused adhesions that make subsequent surgeries more painful; in this case, the ethical presumption against multiple surgeries is self-evident. More typically, surgeries are essentially separate, additive events: Consider the case of cycling

a guinea pig from a craniotomy project onto one that requires abdominal surgery. In this case, the prior surgery has a neutral effect on the pain and distress of the subsequent surgery, though the regulatory presumption would still be in favor of killing the first animal and replacing with another. Finally, there might be cases where there is less cumulative pain and distress when performing multiple surgeries on fewer animals. Consider an animal already carrying multiple implants for single-cell brain recording, possibly a recording cylinder, a head restrainer, and some electromyogram leads on the arm muscles. Creating a second craniotomy to study a different part of the brain (say, for hearing research instead of the initial study's psychomotor investigations) means less total surgery than putting a head restrainer and a recording cylinder on a new animal.

What criteria can guide an IACUC's review of whether to approve multiple major survival surgeries on an animal? Perhaps there is some unarticulated notion of fairness that limits surgery per animal (notice the inherent assumption that death is generally preferable to undergoing major survival surgery), though this still begs the regulatory question why surgery is singled out among painful procedures for special caution. The authors believe that IACUCs certainly should consider the sum of the animal's experiences and the impact multiple procedures are likely to have. However, the regulations give no reason for the proscription against multiple survival surgeries, and American IACUCs have limited flexibility to seriously evaluate animal welfare as the basis for their determination (Carbone, 1997).

G. IACUCs, Veterinarians, and the Standard of Care

IACUCs balance the potential harms to animals against experimental needs, but also against financial costs, convenience, availability of highly skilled experimenters, the harmful side effects of painkillers, and even tradition. They must decide how activist they want to be in pushing for change. A principal investigator may have good experience with what many would consider an outmoded anesthetic regimen. Forced by the IACUC to shift to a different anesthetic, there may be an increase in animal suffering and death, either because of inexperience with the newer method or because of previously unknown strain effects. The IACUC must be cautious about forcing change that could harm the animals. Similarly, the authors caution against excessive IACUC-mandated pilot studies. Investigators should certainly be asked to report on early or pilot animals when embarking on work with a new or unfamiliar model. In some situations—one example might be looking for subtle effects of analgesics on certain biochemical parameters—a pilot study will fail to find a real effect simply because the effect is too small for the sample size to detect.

Scientists, IACUCs, and veterinarians often work with incomplete or probabilistic knowledge of the pain entailed in experiments, and of the efficacy of pain management strategies. A general principle of "when in doubt, treat for pain"

may be well in most situations, but it must acknowledge that analgesic use itself can have negative effects on animals, and carries costs of time, effort, money, documentation, and more for staff. Consider a protocol in which mice will receive post-surgical buprenorphine at 10 p.m. and will next be assessed at 8 a.m. If there is a slight risk that at least some animals may be in pain by 4 a.m., must the scientist come in then for an assessment? Can he/she rely instead on the presumption that buprenorphine should give adequate analgesia for most such animals? Who gets the benefit of doubt—the sleep-deprived investigator or the (potential) outlier mouse?

Advances in pain recognition in laboratory animals (Roughan and Flecknell, 2000) will increasingly take the guesswork out of protocol review. Careful prospective planning and retrospective/ongoing assessment allow the scientist and IACUC to negotiate a frequency of assessment and treatment that efficiently optimizes pain management.

The importance of training and competence in the minimization of pain and distress cannot be overemphasized. While this may seem self-evident, it is not unusual to see institutional training programs based on a process that puts more emphasis on documenting attendance of training than on evaluating competence. While both are important, the performance goal is really dependent on how well the individual actually performs a given task. In the case of hands-on animal procedures, this involves a combination of manual skills, experience, and also a large dose of the human element. We know that the same procedure in different hands may have very different outcomes. Accordingly, it is important to factor in such things as a caring attitude, attention to detail, and work ethic into the total picture of evaluating how effectively pain and distress are minimized in a given situation. Training must include assessment of the animal, and in particular, methods for detecting pain and distress.

All medical practice entails setting a standard of care, charting a course between "best practice" (in a mythical realm of unlimited skill and resources) and "good enough." We encourage laboratory animal veterinarians to aim always for best practice that truly minimizes animal pain and distress, and for IACUCs and scientists to closely follow their lead.

ADDITIONAL READING

- Kraus, A.L., and Renquist, D. (eds.) (2000). "Bioethics and the Use of Laboratory Animals: Ethics in Theory and Practice." George C. Benoit Publishing, Dubuque, IA.
- Nuffield Council on Bioethics. (2005). "The Ethics of Research Involving Animals." Latimer Trend & Co., London.
- ILAR Journal 1999 issue on ethics: http://dels.nas.edu/ilar_n/ilarjournal/40_1/
 Web sites: http://bioethics.net/resources/index.php?t=sub_pages&cat=64
<http://bioethics.od.nih.gov/animals.html>

REFERENCES

- 91st Congress. (1970). Animal Welfare Act of 1970, Public Law 91-579.

- American Association for Laboratory Animal Science (AALAS). (2003). AALAS position statement: Recognition and alleviation of pain and distress in laboratory animals. Available on-line at http://www.aalas.org/association/position_statements.asp
- American College of Laboratory Animal Medicine (ACLAM). (2001). Position statement on pain and distress in laboratory animals. Available on-line at http://www.aclam.org/education/guidelines/position_pain-distress.html
- American College of Veterinary Anesthesiologists. (1998). American College of Veterinary Anesthesiologists' position paper on the treatment of pain in animals. *J. Am. Vet. Med. Assoc.* **213**(5), 628–630.
- American Veterinary Medical Association. (2003). Veterinarian's Oath (updated November 1999). In "AVMA Membership Directory and Resource Manual." p 398. American Veterinary Medical Association, Schaumburg, IL.
- American Veterinary Medical Association. (2007a). Principles of veterinary medical ethics of the American Veterinary Medical Association. In "AVMA Membership Directory and Resource Manual." p 1046. The American Veterinary Medical Association, Schaumburg, IL.
- American Veterinary Medical Association. (2007b). Veterinarians rate high on honesty, ethics. *J. Am. Vet. Med. Assoc.* **230**(3), 332.
- Animal and Plant Health Inspection Service, USDA (APHIS). (1989). Animal Welfare; final rules. *Fed. Regist.* **54**(168), 36112–36163.
- Animal and Plant Health Service, USDA. (1971). Title 9: Animals and animal products. *Fed. Regist.* **36**, 24917.
- Beauchamp, T.L., and Childress, J.F. (1994). "Principles of Biomedical Ethics." Oxford University Press, New York.
- Brown, K.M., Saunders, M.M., Kirsch, T., Donahue, H.J., and Reid, J.S. (2004). Effect of COX-2-specific inhibition on fracture-healing in the rat femur. *J. Bone Joint Surg. Am.* **86**-A(1), 116–123.
- Brown, M., Carbone, L., Conlee, K.M., Dawkins, M.S., Duncan, I.J., Fraser, D., Griffin, G., Hampshire, V.A., Lambert, L.A., Mench, J.A., Morton, D., Richmond, J., Rollin, B.E., Rowan, A.N., Stephens, M.L., and Wurbel, H. (2006). Report of the Working Group on Animal Distress in the Laboratory. *Lab. Anim. (NY)* **35**(8), 26–30.
- Carbone, L. (1997). SVME issues forum. *Soc. Vet. Med. Ethics Newsl.* **3**(1), 2–3.
- Carbone, L. (2004). "What Animals Want: Expertise and Advocacy in Laboratory Animal Welfare Policy." Oxford University Press, New York.
- Cigman, R. (1989). Why death does not harm animals. In "Animal Rights and Human Obligations." (T. Regan, and P. Singer, eds.), pp 150–152. Prentice Hall, Englewood Cliffs, NJ.
- Clarke, S., and Lecky, F. (2005). Best evidence topic report. Do non-steroidal anti-inflammatory drugs cause a delay in fracture healing? *Emerg. Med. J.* **22**(9), 652–653.
- DeGrazia, D. (1996). "Taking Animals Seriously." Cambridge University Press, Cambridge.
- DeGrazia, D. (1998). Moral pluralism in animal ethics: An approach neither utilitarian nor rights-based. In "Bioethics and the Use of Laboratory Animals: Ethics in Theory and Practice." (A.L. Kraus, and D. Renquist, eds.). George C. Benoit Publishing, Dubuque, IA.
- Donnelly, S. (1990). Introduction: The troubled middle in media res. *Hastings Cent. Rep. Special Supplement* (May/June), 2–4.
- Edwards, J.L., Pandit, H., and Poppet, M.T. (2006). Perioperative analgesia: A factor in the development of heel pressure ulcers? *Br. J. Nurs.* **15**(6), S20–S25.
- Foundation for Biomedical Research. (2005). Poll shows majority of Americans support animal research (unpublished press release). Available on-line at http://www.fbresearch.org/Journalists/Polls/HartPoll_4_15_05.htm
- Hanson, C.A., Weinholt, P.S., Afshari, H.M., and Dahners, L.E. (2005). The effect of analgesic agents on the healing rat medial collateral ligament. *Am. J. Sports Med.* **33**(5), 674–679.
- Humane Society of the United States. (2001). Americans disapprove of animal research (unpublished press release). Available on-line at http://www.hsus.org/animals_in_research/pain_distress/opinion_poll_on_pain_and_distress_in_research.html
- Institute of Laboratory Animal Resources. (1996). "Guide for the Care and Use of Laboratory Animals." National Academy Press, Washington, D.C.
- Institute of Laboratory Animal Resources, National Research Council. (1978). "Guide for the Care and Use of Laboratory Animal Resources." National Institutes of Health, Bethesda, MD.
- Karas, A., and Silverman, J. (2007). Pain and distress. In "The IACUC Handbook." (J. Silverman, M.A. Suckow, and S. Murthy, eds.), 2nd ed., pp 241–286. CRC Press, Boca Raton, FL.
- Kraus, A.L. (1998). Opening remarks of the ACLAM Forum, May 1998. In "Bioethics and the Use of Laboratory Animals: Ethics in Theory and Practice." (A.L. Kraus, and D. Renquist, eds.). George C. Benoit Publishing, Dubuque, IA.
- National Aeronautics and Space Administration (NASA). (1996). NASA Principles for the Ethical Care and Use of Animals (Sundowner Report). Available on-line at <http://www.quest.nasa.gov/neuron/events/habitat/NASAprin.html>
- Office of Protection from Research Risks. (1986). "Public Health Service Policy on Humane Care and Use of Laboratory Animals." National Institutes of Health, Bethesda, MD. Available on-line at <http://grants.nih.gov/grants/olaw/references/phspol.htm>
- Plous, S. (1998). Opinion Research on Animal Experimentation: Areas of Support and Concern. Proceedings for Pain Management and Humane Endpoints, Washington D.C.; published on-line by Johns Hopkins Center for Alternatives to Animal Testing. Available on-line at <http://altweb.jhsph.edu/meetings/pain/plous.htm>
- Prentice, E.D., Crouse, D.A., and Mann, M.D. (1992). Scientific merit review: The role of the IACUC. *ILAR News* **34**(1–2), 15–19.
- Regan, T. (1983). "The Case for Animal Rights." University of California Press, Berkeley, CA.
- Roughan, J.V., and Flecknell, P.A. (2000). Effects of surgery and analgesic administration on spontaneous behaviour in singly housed rats. *Res. Vet. Sci.* **69**(3), 283–288.
- Russell, W.M.S., and Burch, R.L. (1959). "The Principles of Humane Experimental Technique." Methuen & Co. Ltd, London.
- Tannenbaum, J. (1995). "Veterinary Ethics: Animal Welfare, Client Relations, Competition and Collegiality." Mosby, St. Louis, MI.
- The Federation of American Societies for Experimental Biology (FASEB). (2007). Statement of principles for the use of animals in research and education. Available on-line at http://opa.faseb.org/pages/PolicyIssues/animal_research_restatement.htm
- The Gallup Organization. (2007). Moral issues. Available on-line at <http://www.galluppoll.com/content/?ci=1681&pg=1>
- United States Congress. (1966). Laboratory Animal Welfare Act of 1966, Public Law 89-544. Available on-line at <http://www.nal.usda.gov/awic/legislat/pl89544.htm>
- United States Congress. (1985). Food Security Act of 1985, Public Law 99-198. Title XVII, Subtitle F: Animal welfare. Available on-line at <http://www.nal.usda.gov/awic/legislat/pl99198.htm>
- United States Department of Agriculture (USDA). (1977). Animal welfare: Definition of terms. *Fed. Regist.* **42**(117), 31022–31029.
- United States Department of Agriculture, Animal and Plant Health Inspection Service, Animal Care (USDA). (1997). "Animal Care Resource Guide, Policy No. 11: Painful/Distressful Procedures." Available on-line at <http://www.aphis.usda.gov/ac/publications/policy/policy11.pdf>
- United States Interagency Research Animal Committee. (1985). Principles for the utilization and care of vertebrate animals used in testing, research, and training. *Fed. Regist.* **50**, 20864–20865.

Regulatory Issues

Laura A. Conour, Sonja T. Chou, and Lynn C. Anderson

I. Introduction	569
II. US Animal Welfare Regulations, Policies, and Standards	570
A. Animal Welfare Act and USDA Regulations	570
B. Public Health Service Policy on Humane Care and Use of Laboratory Animals	571
C. Guide for the Care and Use of Laboratory Animals	572
D. Association for Assessment and Accreditation of Laboratory Animal Care—International	572
E. Institutional Policies	573
III. Drug Enforcement Regulations and Policies	573
A. Controlled Substances Act, Title 21 CFR	573
B. Drug Schedules (Title 21 CFR Appendix)	575
C. State Regulations	575
D. Professional Organization Position Statements	576
E. Institutional Policies	576
IV. Occupational Health and Safety Considerations	576
A. Anesthetic Safety Issues	576
B. Drug Abuse Regulations and Issues	576
C. Needle and Syringe Safety Issues	577
V. International Considerations	577
A. Canada	577
B. Europe	577
C. Elsewhere Around the World	578
References	579
Bibliography	579
Laws, Regulations, and Policies	580

I. INTRODUCTION

The purpose of this chapter is to provide a review of the regulations, policies, and standards governing the proper use of anesthesia, analgesia, tranquilizers, and other agents used

to prevent or minimize pain and distress in animals used in research, teaching, and testing. The Animal Welfare Act (AWA)/US Department of Agriculture (USDA) regulations, the Public Health Service Policy on Humane Care and Use of Laboratory Animals, and the *Guide for the Care and Use of*

Laboratory Animals (Guide), which include requirements and guidance regarding the responsibilities of veterinarians, Institutional Animal Care and Use Committees (IACUCs), and research scientists for eliminating or controlling animal pain and distress, are summarized. A brief overview of the US federal and state regulations for the management and use of controlled substances, as well as occupational health and safety concerns associated with anesthetic and analgesic drug use, is also included. In addition, a brief description of related international regulations and policies is provided. For a more comprehensive overview on the laws, regulations, and policies affecting the general use of laboratory animals, please consult *Laboratory Animal Medicine*, 2nd edition (Fox et al., 2002).

II. US ANIMAL WELFARE REGULATIONS, POLICIES, AND STANDARDS

A. Animal Welfare Act and USDA Regulations

The United States Public Law (PL) 89-544, commonly referred to as the AWA, was signed into law in August 1966 (PL 89-544, 1966). The original intent of the AWA was to protect pet animals from being used in biomedical research. However, amendments to the AWA in PL 91-579 (1970), PL 94-279 (1976), PL 99-198 (1985), and PL 101-624 (1990) significantly expanded the scope of the regulations. The amendments led to the establishment of minimal standards for the care and use of animals used in research, teaching, and testing, and added institutional responsibilities for oversight of animal care and use. The amendments also led to regulations for the sale, exhibition, and commercial transport of animals.

Regulations and standards based on the AWA are developed and administered through the USDA, Animal and Plant Health Inspection Service (APHIS), Animal Care (AC). These regulations and standards, published in the Code of Federal Regulations (CFR), Title 9, Animals and Animal Products, Subchapter A, Animal Welfare, Parts 1–4 (2006), require each research facility to identify an Institutional Official (IO) who is authorized to legally commit on behalf of the facility that the USDA requirements will be met.

The USDA regulations provide minimal requirements for the humane handling, care, and treatment of dogs, cats, guinea pigs, hamsters, rabbits, nonhuman primates, and other warm-blooded species used in research, teaching, and testing. However, the regulations specifically exclude from USDA oversight some other commonly used species of laboratory animals, including purpose-bred birds, mice of the genus *Mus* and rats of the genus *Rattus*, and farm animals used for production agriculture research. These regulations also emphasize the need to provide adequate veterinary care for laboratory animals and prescribe the responsibilities of the attending veterinarian (AV), investigators and the research institution to minimize animal pain and

distress. The USDA “Animal Care Policy Manual,” which does not have the force of regulation, further clarifies the intent of the regulations and standards and provides additional guidance for research institutions.

The AV for each research institution has the authority to ensure the provision of adequate veterinary care and to oversee the adequacy of other aspects of animal care and use. Adequate veterinary care must include appropriate facilities, personnel, equipment, and services within the research institution to comply with the USDA regulations. Appropriate methods to prevent, control, diagnose, and treat diseases and injuries, and the availability of emergency, weekend, and holiday care must also be made available for all the animals regulated by the AWA. Daily observations must be performed to assess animal health and well-being. The veterinarian must also provide guidance to principal investigators and other personnel involved in the care and use of animals regarding handling, immobilization, anesthesia, analgesia, tranquilization, and euthanasia of animals. For surgical procedures, all pre- and post-procedural care must be performed in accordance with currently established veterinary medical and nursing procedures, including the relief of pain and distress (9 CFR, Chapter 1, Subchapter A, Part 2, Section 2.33, 1989). Drugs administered to relieve pain or distress and emergency drugs must not be used beyond their expiration date. Expired medical materials, such as sutures, may be used for acute terminal procedures, provided that this practice does not adversely affect the animal’s well-being or compromise the validity of the scientific study; however, proper anesthesia, analgesia, and euthanasia with non-expired agents are required for all terminal and nonterminal procedures. Pharmaceutical-grade agents should be used, unless the use of non-pharmaceutical grade has been specifically reviewed and approved by the IACUC on the basis of scientific necessity (USDA/APHIS/AC Policy No. 3, 2007).

To help assure humane use of experimental animals, the 1985 amendment to the AWA required every animal research facility to establish an Institutional Animal Care Committee, designated by the USDA as an IACUC, to assess the research facility’s program of animal care, procedures, and facilities. At a minimum, this committee must be comprised of three members, including a community member and a veterinarian. One of the many functions of the IACUC is to review and approve or require modifications prior to approval of all proposed research activities or significant changes in those activities. Prior to approving the proposed research activity, the IACUC shall ensure that all aspects of the research will be conducted in accordance with USDA regulations, performed by appropriately qualified and trained personnel, and that animal discomfort, distress, and pain will be avoided or minimized. If the procedures may cause more than momentary or slight pain or distress, the investigator must consult a veterinarian to ensure that appropriate sedatives, analgesics, and/or anesthetics will be provided. The IACUC must also be assured that the procedures will be performed with appropriate use of pain-relieving agents. In addition, the

IACUC shall determine if the principal investigator has considered alternatives and provided a written narrative of the methods and sources used to determine that no alternatives to minimize or eliminate pain and distress are available. Paralytics must not be used without anesthesia. If it is necessary to withhold such agents to meet research objectives, then scientific justification must be provided in the research proposal and approved by the IACUC. Any unrelieved pain or distress may continue only for the necessary period of time. Animals that would otherwise experience severe or chronic pain or distress that cannot be relieved must be euthanized during or at the end of the procedure, using methods consistent with the current Report of the American Veterinary Medical Association (AVMA) Panel on Euthanasia (9 CFR, Chapter 1, Subchapter A, Part 2, Section 2.31). Authors note: Subsequent to the publication of the revised USDA regulations on January 1, 2005, the AVMA reissued the Report of the AVMA Panel on Euthanasia as the AVMA Guidelines on Euthanasia (AVMA, 2007).

If the proposed animal activities involve surgery, the veterinarian must be consulted to assure that appropriate provisions, including the use of appropriate anesthesia and analgesia, will be provided. Pre- and post-operative care must also be discussed with the veterinarian during the activity-planning phase (9 CFR, Chapter 1, Subchapter A, Part 2, Sections 2.31 and 2.32). The provision of medical or nursing care must be described in the animal activity proposal, although the veterinarian has the authority to change postoperative care as necessary to ensure the comfort of the animals (USDA/APHIS/AC Policy No. 3, 2007).

The research facility is responsible for ensuring that all scientists, research technicians, animal technicians, and other personnel involved in animal care, treatment, and use are qualified to perform their duties. Instruction must be provided on (1) the humane methods of animal maintenance and experimentation; (2) the concept, availability, and use of research or testing methods that limit the use of animals or minimize animal distress; (3) the proper use of anesthetics, analgesics, and tranquilizers for animal species used by the facility, and (4) informational resources available to train employees on appropriate animal care and use (9 CFR, Chapter 1, Subchapter A, Part 2, Section 2.31 and 2.32).

B. Public Health Service Policy on Humane Care and Use of Laboratory Animals

The first Public Health Service (PHS) policy regarding research animal care and use was issued in 1973 and evolved from the 1971 National Institutes of Health (NIH) Policy, "Care and Treatment of Laboratory Animals." When the PHS policy was revised in 1979, it required each institution receiving PHS grants to have a committee (IACUC) to maintain oversight of its animal care program. It also expanded the definition of animal to include all vertebrates. The revised policy also required each

institution to submit an Animal Welfare Assurance Statement to the Office for Protection of Research Risks (OPRR) (now Office of Laboratory Animal Welfare, OLAW) that it would comply with the PHS policy requirements and provisions of the *Guide*. Like the 1973 PHS policy, the 1979 revision accepted accreditation by the American Association for Accreditation of Laboratory Animals Care (AAALAC) (now Association for the Assessment and Accreditation of Laboratory Animal Care—International) as a means of assuring conformance with the *Guide*.

The PHS policy was revised again in 1986 and incorporated provisions of the Health Research Extension Act of 1985, Animals in Research, Section 495, which mandated the Secretary of Health and Human Services to establish guidelines for the proper care and treatment of animals used in biomedical and behavioral research funded by the PHS (PL 99-158, 1985). The Act specifically required the appropriate use of tranquilizers, analgesics, anesthetics, paralytics, and euthanasia. The Act also mandated animal care committees, appointed by the chief executive officer of each institution, that included at least three members. One member must be an individual not affiliated with the institution and another member must be a doctor of veterinary medicine. The PHS policy requires each committee to have a minimum of five members (unlike the Act, itself), including a veterinarian, a practicing scientist with experience in research involving animals, a member whose primary concerns are in a nonscientific area, and a nonaffiliated member. It also allows an individual who meets the requirements of more than one of these categories to fulfill more than one requirement. The Act and the 1986 edition of the PHS policy also required research institutions to provide training for scientists, animal technicians, and others involved in animal care, treatment, or use. This training or instruction must include information on humane animal care and use, and research or training methods that would minimize the number of animals required to obtain valid results and minimize animal distress. In 2002, the PHS policy was amended to permit institutions with PHS Animal Welfare Assurances to submit verification of IACUC approval of competing applications or research proposals subsequent to peer review but prior to award. However, the principles regarding pain and distress remained unchanged.

The 1986 PHS Policy on Humane Care and Use of Laboratory Animals (PHS policy) also endorsed and incorporated the nine "U.S. Government Principles for the Utilization and Care of Vertebrate Animals Used in Testing, Research, and Training," (U.S. Government Principles) which were promulgated in 1985 by the Interagency Research Animal Committee (IRAC). The IRAC included representatives of all federal agencies that use or require the use of experimental animals. To this day, all the US government agencies that develop requirements for studies involving the use of vertebrate animals must consider these principles. Furthermore, agencies that perform or sponsor such studies must, through their IO, assure that those individuals who perform the studies adhere to the principles. Three of these

principles specifically address pain and distress. Principle IV states, "avoidance or minimization of discomfort, distress and pain when consistent with sound scientific practices, is imperative." This principle also states, "unless the contrary is established, investigators should consider that procedures that cause pain or distress in human beings may cause pain or distress in other animals." Principle V requires that "procedures with animals that may cause more than momentary or slight pain or distress should be performed with appropriate sedation, analgesia, or anesthesia. Surgical or other painful procedures should not be performed on unanesthetized animals paralyzed by chemical agents." Principle VI requires that "animals that would otherwise suffer severe or chronic pain or distress that cannot be relieved should be painlessly killed at the end of the procedure or, if appropriate, during the procedure."

The implementation, interpretation, and evaluation of facility compliance with the PHS policy are performed by the NIH OLAW. Any institutions receiving support through the PHS for animal research, teaching, testing, or animal-related activities must provide written assurance of their compliance with the PHS policy. In their PHS Animal Welfare Assurance Statement, each institution must include a synopsis of the training or instruction that is offered to all animal users, including the humane practice of animal care and use, and research or testing methods that minimize animal pain and distress. The PHS policy also requires institutions to use the *Guide* (NRC, 1996; or subsequent editions) as the basis for developing and implementing their institution's animal care and use program.

C. Guide for the Care and Use of Laboratory Animals

The *Guide* provides guidance based on the U.S. Government Principles and is used as the basis for institutional animal care and use program development. Written and published by the Institute for Laboratory Animal Research (ILAR), Commission on Life Sciences, National Research Council, this document establishes performance standards for the care and use of all vertebrate animals. It is recognized by both the PHS and the AAALAC as the primary reference on laboratory animal care and use programs.

Similar to the USDA regulations and the PHS policy, the *Guide* holds the research institution responsible for ensuring that investigators, technical personnel, trainees, and visiting investigators who perform animal anesthesia, surgery, or other experimental manipulations are qualified through training or experience to accomplish these tasks in a humane and scientifically acceptable manner. Each institution should provide for formal or on-the-job training to facilitate effective implementation of the program and humane care and use of animals.

In contrast to the USDA regulations and the 1985 Health Research Extension Act, the *Guide* does not specify a minimum number of members, but recommends that the IACUC

consist of a doctor of veterinary medicine, at least one practicing scientist experienced in research involving animals, and at least one public member to represent the community's interests.

The *Guide* also reinforces that veterinary medical care is an essential part of an animal care and use program and specifies the responsibility of the AV. An effective veterinary medical program should incorporate aspects of recognizing and managing animal pain and distress. This should include proper management of protocol-associated disease or disability, anesthesia and analgesia use, surgery, pre- and post-surgical care, and euthanasia.

The *Guide* acknowledges, "pain is a stressor and, if not relieved, can lead to unacceptable levels of stress and distress in animals." Minimization of pain, stress, and distress may be accomplished, in part, through the provision of proper guidance on appropriate animal handling, immobilization, and euthanasia to all research and husbandry personnel involved in animal care and use. The *Guide* also asserts that the "proper use of anesthetics and analgesics in research animals is an ethical and scientific imperative." Veterinary medical guidance or oversight of surgery programs and pre- and post-surgical care is essential to prevent or minimize pain. Other classes of drugs such as sedatives, anxiolytics, and neuromuscular blocking agents are not analgesic or anesthetic and thus do not relieve pain, but they may be used in conjunction with analgesics and anesthetics to alleviate animal pain and distress.

Investigators preparing animal use protocols, and IACUC members reviewing such protocols, must consider alternative, less-invasive procedures to avoid pain or distress. The IACUC must also, on behalf of the institution, ensure the adequacy of training and experience of personnel performing the procedure. In addition, the IACUC must ensure that the protocol: (1) includes the use of appropriate sedation, analgesia, and anesthesia during major operative procedures; (2) provides for proper pre- and post-procedural care; (3) articulates the criteria and process for timely intervention, if necessary; and (4) describes the endpoints for removal of animals from a study. Euthanasia should be conducted if unrelieved painful or stressful outcomes are anticipated.

D. Association for Assessment and Accreditation of Laboratory Animal Care—International

AAALAC International is a private, nonprofit organization that promotes the humane treatment of animals in science. The AAALAC accreditation program started in 1965 as an activity of the American Association for the Accreditation of Laboratory Animal Care, which accredited hundreds of institutional animal care and use programs throughout the United States. In 1996, the name was changed to underscore that AAALAC International accredits institutional animal care and use programs around the world. This voluntary accreditation and assessment program is based primarily on the *Guide*. Other references listed

on the AAALAC International website (<http://www.aaalac.org>) may also be used as the basis for assessing animal care and use programs. AAALAC International publishes position statements that can be used as supplemental guidelines in dealing with issues such as the use of farm animals, occupational health and safety, and adequate veterinary care.

AAALAC International recognizes that veterinary care is an essential part of an animal care program and supports the regulations and policies that require the veterinarian to either be board certified by the American College of Laboratory Animal Medicine or have training or experience in laboratory animal science and medicine in the species being housed and used. The veterinarian should also contribute to the establishment of appropriate policies and procedures for ancillary aspects of veterinary care. The veterinarian must provide guidance to all personnel involved in the care and use of animals to ensure appropriate animal handling, immobilization, sedation, analgesia, anesthesia, and euthanasia, as well as provide oversight of animal surgery, and pre- and post-surgical care.

By attaining AAALAC accreditation, a research institution demonstrates that it has established practices that meet or exceed existing regulations and standards to achieve excellence in animal care and use. Institutions that apply for AAALAC accreditation must provide a written program description covering: (1) institutional policies and responsibilities; (2) animal environment, housing, and management; (3) veterinary medical care; and (4) physical plant. Under the section on veterinary medical care, surgical activities, assessment of animal pain and distress, use of analgesia and anesthesia, euthanasia methods, and drug storage and control are described in detail.

E. Institutional Policies

Each research institution should develop, communicate, and implement policies that support the humane care and use of animals within their institution. These policies should help to assure compliance with applicable laws, regulations, and policies, and address the specific requirements of the institution. The scope and complexity of institutional policies will depend on the nature of the research and species of animals used and may exceed the minimal regulatory requirements. For example, an institution may appoint more than the minimal number of members required to serve on the IACUC. Institutional policies may also address the specific provisions for preventing pain or distress and the use of pain-relieving agents. Another example would be a policy outlining the institution-specific process for IACUC review of concerns involving the care and use of animals. As described in the USDA regulations, these concerns may result from public complaints received and from reports of noncompliance received by research facility personnel or employees. This may include investigating inappropriate use of anesthetics or analgesics or withholding the use of pain-relieving agents when it is warranted.

III. DRUG ENFORCEMENT REGULATIONS AND POLICIES

Many of the agents used to prevent or minimize pain in laboratory animals are subject to laws and regulations that govern their manufacture, importation, possession, and distribution. In general, these are referred to as “controlled substances.” There are three tiers of law that provide the structure governing the medical use and diversion of controlled substances: International Treaties (2), Federal Laws and Regulations, and State Laws and Regulations. These laws are supplemented by policy statements on the responsible use of controlled substances by a number of veterinary and medical practitioner organizations and state and federal governmental departments (Joranson and Gilson, 1994).

The 1961 Single Convention on Narcotic Drugs (INCB, 1961) and the 1971 Convention on Psychotropic Substances (also known as the Vienna Convention; INCB, 1971) are the two conventions that govern international manufacture, use, and distribution of controlled substances. These two treaties are governed by the World Health Organization (WHO). The UN Commission on Narcotic Drugs is the office responsible for maintaining and updating the controlled drug schedules in these two conventions.

The first US federal legislation to regulate the prescription of drugs was enacted in 1914 as The Harrison Narcotic Act. In 1970, the Office for Drug Abuse Law Enforcement and the Office of National Narcotics Intelligence were merged to form the Drug Enforcement Administration within the Department of Justice. As a result, a single federal statute regulates the manufacture, importation, possession, and distribution of controlled substances in the United States [The Controlled Substances Act (CSA), 21 CFR]. The Practitioners Manual (2006) published by the Drug Enforcement Agency (DEA) is a comprehensive document to guide practitioner’s in the prescription, administration, and dispensing of controlled substances. Individuals establishing controlled substances record-keeping and acquisition systems for a laboratory animal facility should consult this document.

A. Controlled Substances Act, Title 21 CFR

The CSA is administered by the Secretary of Health and Human Services and enforced by the DEA. An underlying purpose of the CSA is to enable the United States to meet all of its obligations under international treaties. It was amended in 1978 by the Psychotropic Substances Act to add provisions implemented by the Convention on Psychotropic Substances. It was amended again in 1984 by the Controlled Substances Penalties Amendments Act and, in 1988, The Chemical Diversion and Trafficking Act added provisions implementing the United Nations Convention Against Illicit Traffic in Narcotic Drugs and

TABLE 25-1

SUMMARY OF CONTROLLED SUBSTANCES SCHEDULES

Schedule I

- The drug or other substance has a high potential for abuse
- The drug or other substance has no currently accepted medical use in treatment in the United States
- There is a lack of accepted safety for use of the drug or other substances under medical supervision

Examples include heroin, Ecstasy, and LSD

Schedule II

- The drug or other substance has a high potential for abuse
- The drug or other substance has a currently accepted medical use in treatment in the United States or a currently accepted medical use with severe restrictions
- Abuse of the drug or other substances may lead to severe psychological or physical dependence

Examples include cocaine (used as a topical anesthetic), morphine, oxycodone, pentobarbital

Schedule III

- The drug or other substance has a potential for abuse less than the drugs or other substances in Schedules I and II
- The drug or other substance has a currently accepted medical use in treatment in the United States
- Abuse of the drug or other substance may lead to moderate or low physical dependence or high psychological dependence

Examples include buprenorphine and ketamine

Schedule IV

- The drug or other substance has low potential for abuse relative to the drugs or other substances in Schedule III
- The drug or other substance has a currently accepted medical use in treatment in the United States
- Abuse of the drug or other substance may lead to limited physical dependence or psychological dependence relative to drugs or substances in Schedule III

Examples include phenobarbital, Talwin, Valium, chloral hydrate

Schedule V

- The drug or other substance has low potential for abuse relative to the drugs or other substances in Schedule IV
- The drug or other substance has a currently accepted medical use in treatment in the United States
- Abuse of the drug or other substance may lead to limited physical dependence or psychological dependence relative to drugs or substances in Schedule IV

Examples include cough suppressants containing small amounts of codeine

Source: Adapted from CSA Section 812. Also available at <http://www.deadiversion.usdoj.gov/21cfr/21usc/812.htm>

Psychotropic Substances. Federal controlled substances laws also work in tandem with state controlled substances legislation and the requirements set forth by professional licensing boards.

The CSA sets forth the federal laws regarding both legitimate and illicit use of controlled substances. This law also strives to provide a balanced policy of promoting pain relief while preventing abuse of pain-relieving medications. The DEA's statutory responsibility is "to prevent diversion and abuse of these drugs while ensuring an adequate and uninterrupted supply is available to meet the country's legitimate medical, scientific, and research needs."

The international treaties and the CSA established a system for classifying controlled substances according to Schedules I–V, with Schedule I drugs being the most strictly controlled (Table 25-1). Any new or revised scheduling on controlled substances is published in the Federal Register with final ruling issued by the Deputy Administrator of the DEA. Any number of agencies or organizations can recommend scheduling of certain substances with advisement frequently made by the FDA and the Department of Health and Human Services (DHHS).

The aim of this law is to establish a "closed system" of legitimate handling of controlled substances to include manufacturers, distributors, physicians, pharmacies, and researchers. Institutions or individuals who are registered with the DEA must strictly account for any distribution of controlled substances.

The requirement for registration is waived for any practitioner prescribing, administering, or dispensing controlled substances within the Armed Forces, the PHS, or the Bureau of Prisons.

Applicants must register with the DEA using DEA Form 224. The practitioner must also be registered in each state where they prescribe, administer, or dispense controlled substances. A separate registration is required for each "principal place of business" where controlled substances are stored, dispensed, or maintained. Upon approval, applicants are assigned a DEA registration number and given a certificate of registration. A modification of registration must be submitted with a change in physical location of the practitioner's activities.

Storage of Schedules II–V controlled substances in a "securely locked, substantially constructed cabinet" is required. Schedule I controlled substances must be stored in a US Government Class V security container (Practitioner's Manual, 2006).

A number of forms are required for registration with the DEA and prescription of controlled substances. All receiving records must be retained and DEA Form 222 (triplicate form) must be used for receipt of Schedule II drugs. For Schedules III–V drugs, supplier invoices must be retained. Physical records must be maintained of the inventory of controlled substances received, dispensed, or administered, with all records retained for at least a 2-year period.

A “complete and accurate record of the controlled substances on hand” must be maintained. Inventories must be conducted every 2 years. The inventory must contain the date on which the inventory is conducted, the names of the controlled substances, the dosage unit and types, the number of dosage units, the number of commercial containers, and the record of disposition. Any samples received from pharmaceutical companies must also be inventoried (Practitioner’s Manual, 2006).

Theft or “significant loss” of controlled substances requires immediate reporting (within one business day) to the DEA upon discovery of the loss or theft. DEA Form 106 must be completed and filed. Breakage or spillage of controlled substances does not constitute a “loss” of controlled substances. If the controlled substances are not recoverable as a result of breakage or spillage, the circumstances surrounding the breakage must be documented within the inventory records. Two witnesses who observed the breakage must sign the inventory records indicating the circumstances that they witnessed. When disposal of controlled substances occurs, it must, however, be reported to the DEA using DEA Form 41.

Diversion is the illicit use of prescribed drugs for recreational purposes. Illegal distribution of controlled substances or significant record-keeping violations will result in judicial action pursued by the DEA. The Office of Diversion Control within the Drug Enforcement Administration monitors and has authority over the diversion of controlled pharmaceuticals and controlled chemicals. Details regarding Office of Diversion Control Program Description may be found at DEA website (http://www.deadiversion.usdoj.gov/prog_dscrpt/index.html).

Controlled substances can also be surrendered to an area DEA Field Office in person or via mail, with the exception of Schedule I controlled substances. Dispensing expired medications is in direct violation of the federal Food, Drug, and Cosmetic Act and/or the CSA. Most short-dated or expired medications (not Controlled Substances) can be returned to the manufacturer via the Customer Service department or their local sales representative (Crimmins, 2001). For disposal of expired, damaged, or unwanted controlled substances, a reverse distributor should be utilized. Most reverse distributors will accept Schedules II–V controlled substances as well as unused sharps and other non-controlled drugs. Check with your distributors about inventory pickup or mail-in service offerings. DEA Form 222 should be used to transfer Schedules I and II controlled substances to a reverse distributor, while invoices will suffice for transfer for Schedules III–V controlled substances. All documentation of transfers should be maintained for 2 years. The reverse distributor is authorized to destroy controlled substances. A list of area reverse distributors is maintained at each DEA field office.

With cessation of activities involving controlled substances, a written notification of termination of registration must be submitted to the nearest DEA field office. The DEA certificate of registration and any unused order forms (DEA Form 222) must be surrendered along with the written notification (Practitioner’s Manual, 2006).

The CSA also regulates retail sales of over-the-counter pseudoephedrine, phenylpropanolamine, and combination ephedrine products to a specific amount for a single transaction limit. These restrictions were placed in effect to regulate the purchases of these substances for use in the manufacture of methamphetamine or amphetamine.

The Anabolic Steroids Control Act of 1990 (ASCA, Title XIX of PL 101-647) classified anabolic steroids into Schedule III of the CSA. The DEA excluded three veterinary anabolic steroid implants for use in cattle or nonhuman species. Anabolic steroids include hormonal substances related to testosterone. This definition does not include hormonal substances related to estrogen, progestins, and corticosteroids.

B. Drug Schedules (Title 21 CFR Appendix)

The five schedules of controlled substances are published annually in Sections 1308.11–1308.15 of 21 CFR (CSA). Controlled substances are scheduled based on “current accepted medical use in treatment in the US, the relative abuse potential, and the likelihood of causing dependence when abused” (Practitioner’s Manual, 2006). A drug is placed into a schedule as the result of an international treaty, convention, or protocol, or as the result of the findings or criteria for each schedule. These findings are summarized in Table 25-1. Different formulations of the same drug or substance may be contained within different schedules (Sapienza, 2006). Drugs can be added to a schedule, reclassified into a new schedule, or omitted from a schedule at any time throughout the course of the year. The examples provided in Table 25-1 are not the definitive list of scheduled controlled substances; the complete list of Controlled Substances Schedules may be found under Section 812 of 21 CFR.

Substances listed in Schedule I are only permitted for research use. The FDA must qualify researchers and approve research protocols using Schedule I substances and a separate registration to conduct research with a Schedule I controlled substance (Practitioner’s Manual, 2006).

C. State Regulations

The Pain and Policy Studies Group maintains the Database of State Laws, Regulations, and Other Official Governmental Policies, which provides a current resource for all laws, guidelines, and schedules of controlled substances by state applicability (Pain and Policy Studies Group, 2007). While it is based on responsibilities and obligations of human medical doctors, it provides a valuable resource of state statutes relating to controlled substances. Additionally, the National Association of State Controlled Substances Authorities (NASCSA) is an organization which provides a forum for state and federal agencies to work together to provide uniformity in controlled substances

medical use and diversion abuse. Full membership is restricted to those state agencies which are responsible for controlled substances regulations, while associate membership is available to those state and federal organizations that have a stated interest in the uniform regulation of controlled substances but no direct regulatory responsibility.

Registration with the DEA grants practitioners federal authority to handle controlled substances, while the state law for the jurisdiction where the practice is located governs the activities conducted by the DEA-registered practitioner. The practitioner must "abide by the more stringent aspects of both the federal and state requirements;" the state is often more strict than the federal government (Practitioner's Manual, 2006). For example, several states regulate the disposal of controlled substances and these processes take precedence over any DEA procedures. Most investigations of controlled substances violations are carried out by state authorities. If a license to practice is revoked by a state, DEA requests voluntary surrender of the practitioner's DEA registration.

Prescription monitoring programs (PMPs) have been implemented on the state level to monitor the prescription of many controlled substances in an effort to detect those trends indicating illegal prescription or distribution of these drugs. Seventeen states, as of 2002, have implemented PMPs to monitor the prescription of several controlled substances (Joranson et al., 2002).

D. Professional Organization Position Statements

Position statements published by many associations affiliated with various health care professions are intended to support federal and state laws and also substantiate a code of professional ethics. For example, AVMA published a position statement on controlled substances that was approved by the AVMA House of Delegates in 1993 (AVMA, April 2007). This statement recommends the use of controlled substances in accordance with the CSA and for the purpose of humane euthanasia of animals and to reduce the risk of drug abuse. The administration of controlled substances under the direct supervision of a licensed veterinarian is also recommended.

E. Institutional Policies

As noted in Section II, institutions may need to develop specific policies to enforce the relevant laws regarding controlled substances. For example, the institution may establish policies that identify specific requirements for employees who are responsible for receipt, storage, and record-keeping of controlled substances, according to the regulations. They may also determine specifically which employees are permitted to administer controlled substances under the institution's DEA license.

IV. OCCUPATIONAL HEALTH AND SAFETY CONSIDERATIONS

A. Anesthetic Safety Issues

The United States Occupational Safety and Health Administration (OSHA) obligates employers to provide a hazard-free workplace environment. OSHA establishes many hazard-specific safety and health standards, including guidelines for workplace exposure to anesthetic gases. While these guidelines do not represent legally binding requirements, they fulfill a specific need for additional details in this area. These guidelines were originally published in 1999 by the OSHA Directorate for Technical Support in the Office of Science and Technical Assessment and were revised in 2000 (OSHA, 2000).

Waste anesthetic gases (WAGs) are those anesthetic gases that may expose personnel to health hazards during research procedures. WAGs include nitrous oxide, halothane, methoxyflurane, enflurane, isoflurane, desflurane, and sevoflurane. For WAGs, OSHA sets permissible exposure limits (PELs) to protect users against overexposure to hazardous substances. PELs pertain to concentrations of a substance in the air or on the skin, and are based on an 8-hour time-weighted average (TWA) exposure. Many substances have established PELs but in this context, reference to PELs is for gas anesthesia usage available from OSHA website (OSHA, 2006). An effective waste anesthetic gas management program should be designed and implemented where gas anesthesia is utilized in a research facility. This program should not only provide for environmental mechanisms for adequate WAG scavenging to minimize employee exposure but also include a written hazard communication program. Additionally, monitoring of the environment should be performed either continuously or periodically.

OSHA also maintains standards for storage and use of compressed gases in any number of work scenarios. These industry standards from 29 CFR 1910 should be utilized in determining the proper storage conditions of compressed gas cylinders as well as the procedures to secure cylinders in use. Many states have additional standards and policies regarding storage and use of compressed gas cylinders, some of which are OSHA approved and similar to those standards set forth by federal OSHA guidelines. Refer to each individual state's statutes for applicable guideline for your state, available at <http://www.osha.gov/SLTC/compressedgasequipment/standards.html> (OSHA, February 2007).

B. Drug Abuse Regulations and Issues

There are a number of case reports in the literature that describe abuse, injury, and death with misuse of veterinary drugs, many of which are controlled substances (Arditti et al., 2001; Elejalde et al., 2003; Fritz and Neimczyk, 2002; Quail

et al., 2001 and Spoerke et al., 1986). Ketamine[®] (Fort Dodge) is the most commonly abused veterinary drug used in laboratory animals today with the first documentation of recreational use in North America reported as early as 1971 (Kelly, 1999).

For drug abuse treatment options by employers, OSHA, US Department of Labor's Working Partners for an Alcohol and Drug-free Workplace Program, and the Substance Abuse and Mental Health Services Administration (SAMHSA) Division of Workplace Programs all provide a framework for employers to provide employees with drug treatment and rehabilitation options as well as foster a drug-free workplace, and more information may be found at <http://www.osha.gov/SLTC/substanceabuse/index.html> (OSHA, July 2007).

C. Needle and Syringe Safety Issues

In 1991, OSHA issued the Bloodborne Pathogens Standard (29 CFR 1910.1030) (CFR, 1991). In response to the Needlestick Safety and Prevention Act (PL 106-430, 2000), the Bloodborne Pathogens Standard was revised in 2001 to provide standards for the use of safer needle devices as well as requirement for logs of sharps-related injuries (OSHA, May 2007).

V. INTERNATIONAL CONSIDERATIONS

A. Canada

Federal Canadian legislation governing the welfare of all animals, regardless of their purpose, is contained in the Criminal Code of Canada, Section 446, Cruelty to Animals (R.S., 1985, c. C-46). Two Canadian provinces have enacted legislation that specifically addresses animals used in experimentation: Ontario's Animals for Research Act and Alberta's Universities Act. The Health of Animals Act, enacted in 1990 and revised in 1992, primarily addresses prevention and control of livestock diseases. However, it also states, "the Governor in Council may make regulations for the purposes of protecting human and animal health. . . including regulations for the humane treatment of animals and generally governing the care, handling and disposition of (farm) animals." Agriculture Canada has published Codes of Practice for farm animals and ranched fox and mink, which represent the industry standards for humane treatment of these animals.

Animals used for testing new drugs and vaccines or toxins in foods are protected under the 1982 Canadian Food and Drug Act and Regulations. Canada's Bureau of Biologics has the responsibility for monitoring the virulence and efficacy of biologics, most of which are tested in live animals.

The use of experimental animals in Ontario is governed by its Animals for Research Act, enacted in 1980. This act, which is administered by the Ontario Ministry of Agriculture and Food, requires annual registration of all research facilities in

the province. It specifically addresses the use of anesthetics and analgesics to prevent animal suffering and unnecessary pain, Animal Care Committees (ACCs) that include a veterinarian, and minimum standards of care, housing, and procedures.

Alberta passed the Universities Act in 1966, which forbids research institutions from purchasing random source dogs for use in research, but required pounds to make all unclaimed dogs available to medical facilities upon request. In 1972, Alberta Regulation 33-72 was expanded to include the treatment of animals, and specifically required the use of anesthesia, analgesia, and standards of postsurgical treatment of animals. It also addresses the transportation, maintenance, use, and disposal of animals.

The Canadian Council on Animal Care (CCAC) is a national organization that sets and maintains standards for the care and use of animals used in research, teaching, and testing throughout Canada. Federal Canadian agencies, including the Natural Sciences and Engineering Research Council of Canada, the Canadian Institution of Health Research, and the Social Sciences and Humanities Research Council of Canada, actively support the CCAC's mission to assure ethical and proper treatment of animals used in research, including consideration of the 3Rs. Any institutions that receive funding from these agencies must monitor ongoing research involving vertebrates and cephalopods (squid and octopi) and assure compliance with federal and provincial laws, regulations, and guidelines. Furthermore, these institutions must participate in the CCAC's assessment program and hold a valid Certificate of Good Animal Practice confirming compliance with CCAC guidelines and policies. The basis for the CCAC guidelines can be found in the two volumes of *Guide to the Care and Use of Experimental Animals*, with Chapter XI of Volume 1 focusing on anesthesia, available at CCAC website-http://www.ccac.ca/en/CCAC_Programs/Guidelines_Policies/GDLINES/Guidelis.htm (CCAC, 2005).

The Canadian Controlled Drugs and Substances Act (1996, c. 19) is the primary governing piece of legislation related to the use of controlled drugs and substances in Canada. Additional regulations are promulgated by the various provinces within Canada, similar to the state regulations with the United States.

B. Europe

1. United Kingdom

The Animals (Scientific Procedures) Act of 1986 governs the use of laboratory animals in the United Kingdom. The Act assigns responsibility for evaluating the scientific merit of all animal-based research to the Home Secretary. Project licenses are granted by the Secretary of State after considering the potential benefits and likely adverse effects of the proposed research. The Act also requires a 21-member Animal Procedures Committee to advise the Home Secretary on animal use, including the methods used to prevent pain and distress in laboratory animals.

The Misuse of Drugs Act was passed in 1971 by the House of Parliament. This law categorizes controlled substances by classes (<http://drugs.homeoffice.gov.uk/drugs-laws/misuse-of-drugs-act/>):

- Class A for the most harmful substances such as Ecstasy, LSD, heroin, cocaine, magic mushrooms, and amphetamines
- Class B for amphetamines, Ritalin, and pholcodeine
- Class C for cannabis, tranquilizers, GHB, and “some painkillers”

The Inspectorate and Licensing Section of the Home Office Drug Branch is the authority for this Act. A Home Office domestic license is required for the production, supply, or possession of controlled drugs. Security and SOPs compliance must be documented. An annual statement of compliance with the requirements of the Misuse of Drugs legislation is necessary.

Ketamine is not currently classified as a controlled drug in the UK, while it has been classified as a Schedule III controlled substance in the US since 1999 (Wolff and Winstock, 2006).

2. *European Economic Communities*

In 1986, the Council of Ministers of the European Economic Communities (EEC) adopted Directive 86/609/EEC for the Protection of Vertebrates used for Experimental and Other Scientific Purposes. This Directive was intended to assure the approximation of laws, regulations, and administrative provisions of the EEC Member States regarding the protection of experimental animals, and to help avoid differences that might affect the common market. The EEC Directive required all Member States to establish national legislation that would meet the minimal requirements of the Directive. Specifically, the individual country regulations must address methods used to prevent unnecessary pain or distress to animals. Article 8 states, “All experiments must be carried out under general or local anesthesia” unless anesthesia would be more traumatic than the procedure itself or is incompatible with the experimental purpose. If anesthesia is not possible, or after the animal has recovered from anesthesia, analgesics or other appropriate methods should be used, in a timely manner, to limit pain and distress.

C. **Elsewhere Around the World**

Although many countries have had animal welfare laws in place for decades, countries that have recently experienced social and economic development have also promulgated new laws or guidelines to support animal welfare. Prevention and minimization of pain and distress in animals used for research and testing is a recurrent theme in these regulations and guidelines worldwide. Many of them are based, at least in part, on the internationally recognized “3R” principles first proposed by Russell and Burch (1959) that encourage the replacement of

animals by in vitro methods where possible; reduce the number of animals used; and refine techniques to prevent or minimize pain or distress. While a comprehensive review of the regulations governing laboratory animal care and use in every country is not feasible in this chapter, examples of animal welfare laws, regulations, and policies beyond those described for North America and Europe are summarized. Individuals who have responsibility for laboratory animals should understand and help to assure compliance with the prevailing regulations in the country where the animals are being used for research, teaching, or testing.

In Australia, each state and territory is responsible for establishing its respective animal welfare legislation. However, the Australian National Health and Medical Research Council provides guidance for such legislation and helps to ensure the ethical and humane care and use of laboratory animals through the Australian Code of Practice for the Care and Use of Animals for Scientific Purposes (2004). The code stresses the responsibilities of research scientists and investigators and institutions to refine methods and procedures to avoid pain or distress in animals used in scientific and teaching activities.

Animal use in research, testing, and teaching in New Zealand is strictly controlled under the 1999 AWA. Institutions using animals must appoint an Animal Ethics Committee (AEC) to review and monitor research projects according to their code of welfare and must use measures to minimize animal pain or suffering.

Japan’s laboratory animal research is governed by the Law for the Humane Treatment and Management of Animals and the Standards Relating to the Care and Management of Laboratory Animals and Relief of Pain, although no inspections or reports are required. The Fundamental Guidelines for Proper Conduct of Animal Experiment and Related Activities compiled by related government agencies, the Guidelines for Proper Conduct of Animal Experiments developed by the Japan Science Council, and the Guidelines for Animal Experimentation published by the Japanese Association for Laboratory Animal Science also help to promote proper management of laboratory animals and to minimize pain during experimental procedures.

Korean Animal Protection Law also requires the minimization of pain with additional guidance provided by the Korean Association of Laboratory Animal Science’s *Guidelines for Animal Experimentation*.

In Singapore, the Agri-Food and Veterinary Authority (AVA) issues licenses for research animal facilities according to the Animal and Birds (Care and Use of Animals for Scientific Purposes) rules. To secure a license, research facilities must comply with guidelines for the proper treatment and utilization of laboratory animals established by the National Advisory Committee for Laboratory Animal Research (NACLAR) published in 2004. Institutions are required to appoint IACUCs to monitor compliance with the guidelines, and the AVA conducts inspections of the research facilities.

In 1988, the State Science and Technology Commission of the People's Republic of China issued Regulations for the Administration of Laboratory Animals, and the Ministry of Health subsequently provided guidance for those regulations, "Implementing Detailed Rules of Medical Laboratory Animal Administration." In 2001, Regulation GB14925-2001, "Laboratory Animal—Requirement of Environment and Housing Facilities," was issued by China's General Administration of Quality Supervision. These regulations mandate requirements for facility construction; separation of animals according to species and strain disease status and experimental use; food, water, and bedding quality; quarantine; preventative medicine; and animal transportation. The People's Republic of China, Ministry of Science and Technology, issued guidelines for the humane treatment of laboratory animals in 2006 that requires administrators and technicians to assure animal welfare.

The President of Taiwan promulgated the Animal Protection Law in 1998. Chapter III of this Act, "Scientific Application of Animals," mandates that the scientific use of animals "shall inflict the least pain or hurt on the animals" and requires institutions to establish a management panel to supervise the scientific application of animal experiments. In addition, the central government must establish an ethics committee for laboratory animals to supervise and manage the use of animals in research.

The Hong Kong Animal Welfare Advisory Group of the Agriculture, Fisheries and Conservation Department developed the Code of Practice for the Care and Use of Animals for Experimental Purposes published in 2004. This relatively comprehensive document is also based on the "3R" concept of replacement, reduction, and refinement and emphasizes the responsibilities of investigators and institutions to assure animal welfare. Experiments that cause pain or distress for which anesthesia would normally be used in medical or veterinary practice must be carried out using anesthesia appropriate to the species and procedure. Pain management appropriate to the species, the procedure, and the circumstances must be provided, and analgesic and tranquilizer usage should at least parallel usage in medical or veterinary practice. When it is not possible to use anesthetics or analgesics for certain protocols, the endpoint of the experiment must be as early as possible to avoid or minimize animal pain or distress, and death as an endpoint must be avoided whenever possible. If severe pain cannot be alleviated promptly, the animal must be euthanized. Alleviation of pain or distress must take precedence over finishing a research project.

India enacted the Prevention of Cruelty to Animals Act in 1960 to prevent unnecessary animal pain or suffering and established rules for experiments conducted on animals. The Act was amended in 1998 to require each research institution utilizing animals to establish an Institutional Animals Ethics Committee. These committees are responsible for reviewing and supervising the conduct of experiments and compliance with the Act. It also requires the minimization of pain during experimentation and oversight of experimental procedures by

veterinarians or medical doctors. Most research institutions voluntarily follow the 1992 Guidelines for Care and Use of Animals in Scientific Research developed by the Indian National Science Academy. These guidelines describe standards for genetics and breeding, housing and environment, nutrition and feeding, hygiene and disease control, use of anesthetics, euthanasia, personnel training, and animal transportation. The government subsequently appointed the Committee for the Purpose of Control and Supervision of Experiments on Animals (CPCSEA) to develop guidelines to promote the humane care of animals used in biomedical and behavioral research and testing. These guidelines also require scientists to ensure that potentially painful procedures to be conducted under appropriate anesthesia. Unless it is contrary to the research objectives, sedatives and analgesics should also be used to control pain or distress.

REFERENCES

Bibliography

- Arditti, J., Spadari, M., de Haro, L., Brun, A., Bourdon, J.H., and Valli, M. (2001). Ketamine—Dreams and realities. *Acta Clin. Belg. Suppl. 1*, 31–33.
- Bayne, K., and deGreeve, P. (2003). An overview of global legislation, regulation, and policies on the use of animals for scientific research, testing, or education. In "Handbook of Laboratory Animal Science." (J. Hau and G.L. Van Hoosier, eds.), 2nd ed., Vol. 1: Essential principles and practices. CRC Press, Boca Raton, FL.
- Crimmins, W.F. (2001). Disposing of expired drugs: A matter of policy. *J. Am. Vet. Med. Assoc.* **218**, 10.
- Elejalde, J.I., Jouis, C.J., Elzuaz, R., and Pinillos, M.A. (2003). Drug abuse with inhaled xylazine. *Eur. J. Emerg. Med.* **10**(3), 252–253.
- Fox, J.G., Anderson, L.C., Loew, F.M., Quimby, F.W., et al. (2002). "Laws, regulations, and policies affecting the use of laboratory animals. Laboratory animal medicine." 2nd ed., pp 19–33. Academic Press, New York.
- Fritz, G.A., and Neimeczyk, W.E. (2002). Propofol dependency in a lay person. *Anesthesiology* **96**, 505–506.
- Joranson, D.E., Carron, G.M., Ryan, K.M., Schaefer, L., Gilson, A.M., Good, P., Eadie, J., Peine, S., and Dahl, J.L. (2002). Pain management and prescription monitoring. *J. Pain Symptom Manage.* **23**, 231–238.
- Joranson, D.E., and Gilson, A.M. (1994). Controlled substances, medical practices, and the law. In "Psychiatric Practice Under Fire: The Influence of Government, the Media and Special Interests on Somatic Therapies." (H.I. Schwartz, ed.), pp 173–194. American Psychiatric Press, Inc., Washington DC, Reprinted with permission on: <http://www.painpolicy.wisc.edu/publicat/94apps.html>
- Kelly, K. (1999). "The Little Book of Ketamine." Ronin Publishing Co, Berkeley, CA.
- Russell, W.M.S., and Burch, R.L. (1959). "The Principles of Humane Experimental Technique." Methuen & Co. LTD, London (reissued Universities Federation for Animal Welfare, Herts, London, England, 1992; it is available online at: http://altweb.jhsph.edu/publications/humane_exp/het-toc.htm).
- Quail, M.T., Weimersheimer, P., Woolf, A.D., and Magnani, B. (2001). Abuse of telazol: An animal tranquilizer. *J. Toxicol. Clin. Toxicol.* **39**, 399–402.
- Sapienza, F.L. (2006). Abuse deterrent formulations and the Controlled Substances Act. *Drug Alcohol Depend.* **83**(Suppl. 1), S23–S30.
- Spoerke, D.G., Hall, A.H., Grimes, M.J., Honea, B.N. III, and Rumack, B.H. (1986). Human overdose with the veterinary tranquilizer xylazine. *Am. J. Emerg. Med.* **4**, 222–224.

Wolff, K., and Winstock, A.R. (2006). Ketamine: From medicine to misuse. *CNS Drugs* 20, 199–218.

Laws, Regulations, and Policies

Australian Code of Practice for the Care and Use of Animals for Scientific Purposes. (2004). (7th ed.). National Health and Medical Research Council. Australian Government. Available online (http://www.nhmrc.gov.au/publications/synopses/_files/ea16.pdf), accessed on September 3, 2007.

AVMA. (April 2007). The AVMA's position statement on controlled substances approved by the AVMA House of Delegates. 1993. Available online (http://www.avma.org/issues/policy/controlled_substances.asp), accessed on August 3, 2007.

AVMA. (2007). AVMA Guidelines on Euthanasia (formerly "Report of the AVMA Panel on Euthanasia"). Available online (<http://www.avma.org/resources/euthanasia.pdf>), accessed on September 3, 2007.

CCAC. (1993). The Care and Use of Experimental Animals, 2nd ed., Vol. 1. Available online (http://www.ccac.ca/en/CCAC_Programs/Guidelines_Policies/GDLINES/Guidelis.htm), accessed on August 4, 2007.

CFR [Code of Federal Regulations]. (1989). Final Rules: Animal Welfare; 9 CFR Parts 1 and 2. Federal Register, Vol. 54, No. 168, August 31, 1989, pp 36112–36163. Office of the Federal register, Washington, DC.

CFR [Code of Federal Regulations]. (1991). Bloodborne Pathogens. 29 CFR Occupational Safety and Health Standards, Subpart Z Section 1910.1030. Office of the Federal Register, Washington, DC.

CFR [Code of Federal Regulations]. (2006). Title 9, Subchapter A—Animal Welfare, Parts 1–3. Office of the Federal Register, Washington, DC.

China State Science and Technology Commission. (1988). Regulations for the Administration of Affairs Concerning Experimental Animals.

China. (2001). Chinese General Administration of Quality Supervision, Inspection, and Quarantine. "Laboratory Animal—Requirements of Environment and Housing Facilities." Regulation GB14925-2001 (issued August 29, 2001, implemented May 1, 2002).

Controlled Drugs and Substances Act. (1996, c. 19). Department of Justice, Canada. Also available online (<http://laws.justice.gc.ca/en/C-38.8/index.html>), accessed on August 4, 2007.

Criminal Code. (R.S., 1985, c. C-46). Cruelty to Animals. Part XI, Section 446. Available online (<http://laws.justice.gc.ca/en/C-46>), accessed on August 4, 2007.

DEA Office of Diversion Control Program Description. Available online (http://www.deadiversion.usdoj.gov/prog_dscrpt/index.html), accessed on November 30, 2007.

House of Parliament. (1971). The Misuse of Drugs Act 1971. Available online (<http://drugs.homeoffice.gov.uk/drugs-laws/misuse-of-drugs-act>), accessed on August 31, 2007.

Interagency Research Animal Committee. (1985). "U.S. Government Principles for Utilization and Care of Vertebrate Animals Used in Testing, Research, and Training." Federal Register (May 20, 1985).

International Narcotics Control Board. (1961). "Single Convention on Narcotic Drugs, 1961" New York, New York, USA, 1961. Available online (http://www.incb.org/pdf/e/conv/convention_1961_en.pdf), accessed on September 3, 2007.

International Narcotics Control Board. (1971). "Convention on Psychotropic Substances 1971," Vienna, Austria, 1971. Available online (http://www.incb.org/pdf/e/conv/convention_1971_en.pdf), accessed on September 3, 2007.

Ministry of Agriculture and Forestry. (December 1999). Guide to the Animal Welfare Act 1999. Policy Information Paper No. 27, New Zealand.

Available online (<http://www.biosecurity.govt.nz/legislation/animal-welfare-act/guide/awguide.pdf>), accessed on August 31, 2007.

National Research Council. (1996). "Guide for the Care and Use of Laboratory Animals." National Academy Press, Washington, DC.

OSHA. (May 2000). Anesthetic Gases: Guidelines for Workplace Exposures. Available online (<http://www.osha.gov/dts/osta/anestheticgases/index.html>), accessed on August 4, 2007.

OSHA. (October 2006). Permissible Exposure Limits (PELs). Available online (<http://www.osha.gov/SLTC/pel/index.html>), accessed on August 3, 2007.

OSHA. (February 2007). Compressed Gas and Equipment OSHA Standards. Available online (<http://www.osha.gov/SLTC/compressedgasequipment/standards.html>), accessed on August 4, 2007.

OSHA. (May 2007). Bloodborne Pathogens and Needlestick Prevention. Available online (<http://www.osha.gov/SLTC/bloodbornepathogens/index.html>), accessed on August 3, 2007.

OSHA. (July 2007). Workplace Substance Abuse. Available online (<http://www.osha.gov/SLTC/substanceabuse/index.html>), accessed on August 4, 2007.

Pain and Policy Studies Group. (Last update on August 22, 2007). Database of State Laws, Regulations, and Other Official Governmental Policies. Available online (<http://www.painpolicy.wisc.edu/matrix.htm>), accessed on August 31, 2007.

PL [Public Law] 89-544. (1966). Act of August 24, 1966. Commonly referred to as the Laboratory Animal Welfare Act. Title 7, USC, Sections 2131–2156. GPO, Washington, DC.

PL [Public Law] 91-513, 84 Stat 1242. (1970). Controlled Substances Act of 1970, 21 United States Code (USC) 801–890, DEA Regulations, Title 21, Code of Federal Regulations, Parts 1300–1316, enacted October 28, 1970. GPO, Washington, DC. Available online (<http://www.deadiversion.usdoj.gov/21cfr/21usc>), accessed on August 1, 2007.

PL [Public Law] 91-579. (1970). Animal Welfare Act of 1970, enacted December 24, 1970. GPO, Washington, DC.

PL [Public Law] 94-279. (1976). Animal Welfare Act Amendment of 1976, enacted April 22, 1976. GPO, Washington, DC.

PL [Public Law] 99-158. (1985). Health Research Extension Act of 1985, enacted November 20, 1985. Also known as the "Animals in Research" act. GPO, Washington, DC.

PL [Public Law] 99-198. (1985). Food Security Act of 1985, Subtitle F—Animal Welfare. Also called Improved Standards for Laboratory Animals Act, enacted December 23, 1985. GPO, Washington, DC.

PL [Public Law] 101-624. (1990). Food, Agriculture, Conservation, and Trade Act of 1990, Section 2503—Protection of Pets, enacted November 28, 1990. GPO, Washington, DC.

PL [Public Law] 101-647, Title XIX. (1990). Anabolic Steroids Control Act of 1990, enacted November 29, 1990. GPO, Washington, DC.

PL [Public Law] 106-430. (2000). Needlestick Safety and Prevention Act, enacted November 6, 2000. GPO, Washington, DC.

PL [Public Law] 107-171. (2002). Farm Security and Rural Investment Act of 2002, Title X-Miscellaneous, Subtitle D—Animal Welfare, Section 2132–2156, enacted May 13, 2002. Amended Sections 2132 and 2156 of the Animal Welfare Act. GPO, Washington, DC.

PHS [Public Health Service]. (2002). Public Health Service Policy on Humane Care and Use of Laboratory Animals. Department of Health and Human Services, Washington, DC. National Institute of Health, Office of Laboratory Animal Welfare.

Practitioner's Manual (An Informative Outline of the Controlled Substances Act). (2006). Office of Diversion Control. DEA. USDOJ.

USDA Animal and Plant Health Inspection Animal Care Policy Manual. (July 2007). Available online (http://www.aphis.usda.gov/animal_welfare/policy.shtml), accessed on September 7, 2007.

Management of Chronic Pain

George J. DeMarco

I. Introduction	581
A. Definition and Characterization of Chronic Pain	581
B. Prevalence of Chronic Pain	582
C. Impact on Research	582
II. Diagnosis	583
A. Diagnosing Neuropathic Pain	584
III. Treatment	585
A. Ion Channel Modulators	585
B. Tricyclic Antidepressants	586
C. Opioids	586
D. Corticosteroids	587
E. Nonsteroidal Anti-Inflammatory Drugs	587
F. NMDA Receptor Antagonists	587
References	588

I. INTRODUCTION

Chronic pain encompasses a constellation of clinical disorders arising from diverse and dynamic mechanisms. Some chronic pain conditions have no discernable organic cause and many are refractory to therapy. Thus, chronic pain is arguably the most complex and challenging facet of pain medicine.

The clinical management of chronic pain is a daunting task for laboratory animal veterinarians. The difficulties involved in the diagnosis and treatment of chronic pain are compounded by the variety of species encountered, numbers of animals cared for, and the requirements of myriad animal use protocols in research, teaching, and testing. The situation is exacerbated by the scant (if any) training veterinarians receive with

respect to chronic pain in veterinary college and post-graduate programs.

The goals of this chapter are to present a comprehensive review of chronic pain pathophysiology and provide diagnostic and treatment options for this multifarious clinical problem. The author hopes this work will serve to guide veterinarians, investigators, and Institutional Animal Care and Use Committee (IACUC) members in devising rational strategies for managing chronic pain in laboratory animals.

A. Definition and Characterization of Chronic Pain

Several concepts are critical to understanding chronic pain. One is that chronic pain constitutes enduring syndromes,

characterized by unpleasant sensations or distress. Most important is comprehending that chronic pain is pathologic function of the nervous system not simply persistent acute pain (Breen, 2002; Grachev et al., 2000).

In human medicine, chronic pain has been defined as “pain which persists past the normal time of healing” (Bonica, 1953). This definition has significant shortcomings since healing may never occur in chronic pain associated diseases like arthritis, healing may never be recognized as in forms of neuropathic pain, or pain may remit and relapse over time. In light of this, the International Association for the Study of Pain (IASP) has adopted temporal endpoints based on common medical experience to classify chronic pain. The IASP regards 3 months of pain as the most expedient point at which to define the transition from acute to chronic nonmalignant pain (Merskey and Bogduk, 1994). Both operational and temporal definitions have merit and neither has been adopted as the clinical standard. It is noteworthy that these definitions encompass many patterns of occurrence and pain does not need to be continuous in order to be classified as chronic. Since the pain literature is rife with misquotations of this report, the reader is strongly encouraged to read the original second edition of the IASP Classification of Chronic Pain (Merskey and Bogduk, 1994).

The treatment and diagnosis of chronic pain in veterinary medicine is hampered by two glaring deficiencies. One is that no reliable and widely accepted definition for chronic pain exists for animals. The other is that a consistent system for classification and scoring chronic pain in veterinary medicine has not been developed. Although well beyond the scope of this work to define and classify chronic pain in animals, guidelines to facilitate the diagnosis of chronic pain will be suggested.

Although the exact mechanisms responsible for the development of chronic pain have yet to be elucidated, neuroplasticity is likely critical to the conversion from acute to chronic pain (Jabbur and Saade, 1999; Ji and Woolf, 2001). In neuropathic, inflammatory, and cancer models, neuroplastic changes proposed to be involved with chronic pain developed 2–3 weeks after pain induction or lesioning (Cain et al., 2001; Calza et al., 1998; Hains et al., 2003; Schwei et al., 1999; Sharif Naeini et al., 2005; Shimoyama et al., 2005; Wang et al., 2002; Yen et al., 2006), some of which peak 4–6 weeks (Brenowitz, 1983; Yen et al., 2006) or sometime between 3 and 11 weeks (Calza et al., 2000) post pain initiation. Until unequivocal endpoints are established, these data and clinical experience (Muir et al., 2004) support considering pain persisting for 1 month or more as a practical point at which to define the transition from acute to chronic pain in animals. Despite evidence that malignancy-induced pain and bone-cancer pain in particular may be “unique” (Schwei et al., 1999; Urch et al., 2003), there is insufficient data to espouse a separate endpoint for defining cancer-related chronic pain in animals.

Human classification schemes have been adapted for use in dogs and cats to assess pain. Extant methods utilize descriptive categorization of pain based on etiology, embryonic

origin, anatomic location, organ system, duration, and severity (Mathews, 2000; Muir et al., 2004; Wiese et al., 2005). While such systems have utility, the drawback inherent in the clinical application of descriptive pain taxonomy is a failure to identify mechanisms responsible for chronic pain. To best guide the diagnosis and treatment of chronic pain, a clinically valid mechanism-based classification system needs to be developed (Muir and Woolf, 2001; Woolf, 2004).

B. Prevalence of Chronic Pain

The prevalence of chronic pain in laboratory animals is for the most part unknown. A dearth of appropriate methods and the logistics of determining the prevalence of chronic pain across numerous species and facilities make it unlikely that such information will be forthcoming. However, by utilizing existing data, inferences may be drawn that could help institutions judge the potential for chronic pain within a given vivarium. For example, a study of outpatients at a veterinary teaching hospital demonstrated that the prevalence of chronic pain is higher in older populations (Muir et al., 2004). Naturally occurring hyperalgesia, allodynia (Kitagawa et al., 2005; Lovell et al., 2000; Novak et al., 1999), and chronic pain-related neuroplasticity (Iwata et al., 2002; Ramer and Bisby, 1998) occur in aged rats. The prevalence of osteoarthritis, a known etiology for chronic pain, is significantly greater in older macaques (Carlson et al., 1996; Lim et al., 1996; Rothschild et al., 1999), baboons (reviewed in Black and Lane, 2002), cats, rats, mice, and guinea pigs (Bendele, 2001; Clarke and Bennett, 2006). Thus, the prevalence of chronic pain is likely high in populations of aged animals. Conversely, data with respect to gender and chronic pain paints a different picture. In humans, the prevalence of chronic pain is considerably influenced by gender and found to be greater in female populations (Marcus, 2003; Meana et al., 2004; Orfila et al., 2006; Rustoen et al., 2004). Sexual dimorphism relevant to chronic pain has also been demonstrated in rodent models. When compared to male rats, female rats have more persistent induced thermal hyperalgesia (Tall et al., 2001), greater induced mechanical allodynia (DeLeo and Rutkowski, 2000; LaCroix-Fralish et al., 2005), and reduced antinociception (Gaumond et al., 2005). The experimental data in this case points to gender as a factor in the development of induced chronic pain. Contrary to age, a link between female sex and increased prevalence of chronic pain in animals is not compelling or supported by clinical evidence (Muir et al., 2004).

C. Impact on Research

Numerous studies demonstrate that chronic pain exerts both physiologic and behavioral effects, which may influence or bias experimental data. The following section will discuss the

immune, endocrine, and behavioral effects noted in models of chronic pain.

1. Immunologic

Peripheral immunomodulation has been shown in rat models of chronic neuropathic pain. Sciatic nerve chronic constrictive injury (CCI) in rat causes a neuron-dependent increase in delayed-type hypersensitivity (DTH) and decreased antigen-specific IgG (Herzberg et al., 1994, 1996b). The neuropathic enhancement of DTH was ascribed to an increase in substance P release in CCI rats and activation of NK-1 receptors (Herzberg et al., 1996a). Upregulation of mRNA for the potent immunomodulating bradykinin receptor in lumbar dorsal horn ganglia (Levy and Zochodne, 2000) and increased levels of IL-1 β , IL-2, IL-6, and IL-10 in sciatic nerve (Romero-Sandoval and Eisenach, 2006) have also been demonstrated in neuropathic rat models.

Neuroimmune activation (NA) is defined as production of substances and the expression of surface antigens from endothelial and glial cells that enhance CNS immune cascades (DeLeo and Yeziarski, 2001). Activated astrocytes are the glial cells likely responsible for NA-mediated effects in chronic pain (DeLeo et al., 2004; Gordh et al., 2006). Astrocyte activation has been demonstrated in neuropathic and inflammatory models of chronic pain (Garrison et al., 1994; Herzberg and Sagen, 2001; Raghavendra et al., 2004; Tanga et al., 2004) and shown to persist for 150 days in a neuropathic model (Zhang and De Koninck, 2006). Once activated, astrocytes release proinflammatory and neuroexcitatory chemicals such as cytokines, reactive nitrogen species, prostaglandins, and glutamate (Liu et al., 2004; reviewed in Wieseler-Frank et al., 2004, 2005). Astrocytes also regulate numerous aspects of neuronal physiology including modulation of synaptic activity (Araque et al., 1999b). As such the potential exists for chronic pain-activated astrocytes to influence a wide range of neuronal functions (Araque, 2006; Araque et al., 1999a; Eddleston and Mucke, 1993; Mucke and Eddleston, 1993).

2. Endocrine

The hypothalamic–pituitary–adrenal (HPA) axis plays a central role in neuroendocrine responses to chronic pain. In humans, chronic pain can result in altered HPA function and stress-related syndromes associated with functional disturbances in the HPA (Gaab et al., 2005; McBeth et al., 2005). Although not thoroughly investigated, chronic pain-altered HPA function has been demonstrated in rats and appears to be very model dependent. Changes in HPA function have been well documented in a rat model of induced inflammatory chronic pain but not in neuropathic models (Bomholt et al., 2005; Ulrich-Lai et al., 2006). Most if not all of the extant data on the relationship between HPA function and chronic pain has been elucidated in the rat adjuvant-induced inflammatory arthritis (AA) model.

HPA alterations noted in the AA model include increased basal plasma ACTH and corticosterone, increased hypothalamic vasopressin, induction of arginine vasopressin mRNA in the paraventricular nucleus (PVN) and proopiomelanocortin mRNA expression in the anterior pituitary, decreased portal (brain) corticotropin releasing hormone (CRH) concentrations, and decreased expression of PVN CRH, and hippocampal mineralocorticoid and glucocorticoid receptor (GR) mRNA (reviewed in Blackburn-Munro, 2004; Blackburn-Munro and Blackburn-Munro, 2001; Bomholt et al., 2004). Most importantly, AA blunts acute physical and psychological stress-induced increases in plasma ACTH and cortisone (Aguilera et al., 1997; Harbuz et al., 1997; Windle et al., 2001) and their normal circadian fluctuations (Persellin et al., 1972; Sarlis et al., 1992).

3. Behavioral

Chronic pain reportedly causes depression, anxiety, and impaired emotional decision-making in people (Apkarian et al., 2004; Dworkin and Gitlin, 1991; Wilson et al., 2001). Anxiogenic effects of induced chronic pain have been demonstrated in mouse and rat. Chronic inflammatory and neuropathic pain in mouse causes anxiety-like behaviors in the light–dark and elevated plus-maze tests (Narita et al., 2006a, 2006b). Chronic pain has also been shown to alter gene expression (NK-1 receptor, BDNF, CRH, GR mRNA) and neurogenesis in limbic brain areas of rat, changes associated with anxiety and depression (Dranovsky and Hen, 2006; Duric and McCarron, 2006; Ulrich-Lai et al., 2006).

In summary, chronic pain can significantly influence immunologic and endocrine function and behavior. Since investigation of the effects of chronic pain on these systems is nascent, the list and variety of consequences will surely expand over time. Considering the substrates for behavior, immune, and endocrine functions are interrelated with numerous physiologic processes, there is great potential for chronic pain to bias research in many fields.

II. DIAGNOSIS

Accurate diagnosis of chronic pain requires appropriate characterization of clinical signs, in particular their temporal characteristics. Signs of pain that persist for a month or more should be classified as chronic. Pain that persists beyond the time wound or lesion healing is expected to be complete certainly constitutes pathologic pain. Mechanistically, it may or may not be chronic if the duration is less than 1 month. The laboratory animal veterinarian, IACUC members, and investigator should take advantage of extant knowledge regarding disease models and experimental procedures involving animals. Animals undergoing procedures or administered chemicals known to be risk factors for inducing chronic pain (e.g., those that cause chronic inflammation or nervous system injury or disease) should be

monitored for the development of chronic pain. Likewise, if a human or animal disease is associated with chronic pain, it should heighten awareness for the development of chronic pain in animal models. It should also be kept in mind that frequently in people no proximate physical cause for chronic pain can be determined and a similar phenomenon may occur in animals.

Although hyperalgesia, allodynia, and spontaneous pain are hallmarks, no single clinical sign is pathognomonic for chronic pain (Wallace, 2005), nor have chronic pain ethograms been established in veterinary medicine. However, methods relevant to diagnosing and measuring chronic osteoarthritic pain and its effects on quality of life in dog have been described (Hielm-Bjorkman et al., 2003; Wiseman-Orr et al., 2004). Similar techniques may be useful in other species and chronic pain syndromes. As with any condition, accurately diagnosing chronic pain requires a good and thorough history, observation, and physical and neurologic examinations. Observation is particularly important for species requiring sedation for complete physical examination, which often confounds or makes a neurologic examination difficult. For descriptions of clinical signs and diagnostic paradigms relevant to inflammatory and neoplastic pain, the reader is referred to standard veterinary texts and the following studies: Duncan et al. (1991) and Hielm-Bjorkman et al. (2003). Here, specific consideration will be given to neuropathic pain, which is generally not described.

A. Diagnosing Neuropathic Pain

Clinical signs of neuropathic pain can be spontaneous, evoked, or combinations of both. Signs may be continuous, intermittent or paroxysmal, and varied in intensity. In human medicine, positive (“electric-shock,” “burning,” “tingling,” “cold,” “pricking,” and “itching”) and negative (sensory deficits, numbness) sensations are characteristic of neuropathic pain. Since animals cannot communicate the nature of what they sense to this degree, veterinarians are dependent on signalment (genotype, expected phenotype), anamnesis (experimental history, duration of signs), and physical/neurologic examination. On physical examination, the presence of sensory, motor, and/or proprioceptive deficits along with signs of pain suggests a neuropathic etiology. Behaviors associated with spontaneous pain include licking/directed grooming (Grelak et al., 2005), biting, autotomy, scratching, lameness, paw lifting or shaking (Santos Tde et al., 1999), and guarding the affected area (Kingery and Vallin, 1989; Xu et al., 1997). Evoked pain (allodynia and hyperalgesia) may manifest as nocifensive behaviors elicited by routine procedures or handling and are evaluated by the somatosensory component of the neurologic examination. Allodynia can be static or dynamic and may be evoked by thermal and/or mechanical stimuli. Dynamic allodynia can be assessed by light strokes with a fingertip, cotton swab, or paintbrush, and

static allodynia by slow application of perpendicular pressure with a pencil eraser or cotton swab (Herr, 2004). Thermal allodynia may be determined by application of a dry glass or metal object cooled in a refrigerator or warmed to 45°C. Hyperalgesia is diagnosed if the animal exhibits exaggerated responses to single or multiple pinpricks. Summation, which is increasing pain with repeated stimuli of the same intensity, and after-sensation, which is a prolonged response to stimuli, are also characteristic of neuropathic pain (Wallace, 2005). Somatosensory examination of the area from which pain is noted and surrounding (uninjured) areas is important to assess peripheral and central sensitization.

Determining the location and distribution of signs is important and should be performed. This information often correlates with the extent of the lesions and with few exceptions, the distribution of pain-related signs matching the anatomic level of the lesion (Chong and Bajwa, 2003; Hansson, 2002). Constructing a dermatome chart can be very useful in recognizing nerve-related patterns and the topographic distribution of signs noted on physical examination can help guide refinement by the neurologic examination. The diagnosis of neuropathic pain is derived almost exclusively from the history and physical/neurologic examination. Clinical pathology, imaging, or neurophysiologic tests cannot measure pain, do not assess function of nociceptive pathways, and may be normal in an individual with significant pain (Jensen and Baron, 2003). At best, diagnostic testing provides correlates to clinical information or can confirm or exclude the presence of a nerve lesion or dysfunction (Cruccu and Truini, 2006; Herr, 2004; Wallace, 2005). With that in mind, if the following criteria are met, a diagnosis of neuropathic pain can be made with a high degree of certainty:

1. Pain in a neuroanatomically defined area, i.e., corresponding to a peripheral or central innervation territory
2. A history of relevant disease or lesion in the nervous system, which is temporally related to development of pain
3. Partial or complete sensory loss in all or part of the painful area
4. Confirmation of a lesion or disease by a specific test, e.g., surgical evidence, imaging, clinical neurophysiology, and biopsy

It should be noted that criterion 3 may be very difficult to assess in animals because sensory loss may be masked by hypersensitivity within and around innervation territories of damaged nerves (Kehlet et al., 2006, reprinted with permission from Elsevier).

Ideally, diagnosis and treatment of chronic pain would be mechanism based (Jensen and Baron, 2003; Woolf and Max, 2001). Until such methods are available every attempt should be made to determine if chronic pain is inflammatory, neuropathic, or neoplastic in origin as this may influence initial treatment choices. Table 26-1 outlines clinical findings that may help distinguish neuropathic from inflammatory chronic pain.

TABLE 26-1

CHARACTERISTIC FEATURES OF NEUROPATHIC AND INFLAMMATORY PAIN		
	Neuropathic pain	Inflammatory pain
Positive signs		
Spontaneous pain	Yes	Yes
Heat hyperalgesia	Rarely	Often
Cold allodynia	Often	Rarely
Aftersensations	Often	Rarely
Paroxysms	Often	Rarely
Hyperpathia (increased threshold and hyperalgesia)	Often	Never
Negative signs		
Sensory loss in damaged nerve territory	Yes	No
Motor deficit in damaged nerve territory	Often	No

Modified from Kehlet et al. (2006), with permission from Elsevier.

III. TREATMENT

The title of this chapter is most apt, because once chronic pain develops, treatment involves a management endeavor, likely for the life of the afflicted. From the previous discussion two concepts should be evident: (1) the development of chronic pain should be prevented if possible and (2) the ideal goal of treatment should be to return pathologic systems neurologic-endocrine-immune responsible for chronic pain to normal function. Unfortunately, it is painfully evident from human medicine that neither has had tremendous success. In people, the prevalence of persistent pain associated with surgical procedures is about 10–50%. Postsurgical chronic pain can arise from inflammation or more likely from iatrogenic nerve damage (Kehlet et al., 2006). Although risk factors for the development of postsurgical chronic pain in animals have not been identified, good tissue handling, avoiding damage to major nerves, and using minimally invasive techniques (e.g., laparoscopic, thoracoscopic) during surgical procedures may help reduce the potential for developing chronic pain (Kehlet et al., 2006). It is also noteworthy that intense, acute, postoperative pain is a risk factor for the development of chronic pain (Perkins and Kehlet, 2000).

Although probably efficacious for preventing chronic inflammatory pain, preemptive and aggressive multimodal analgesia have not proven to be prophylactic “magic-bullets” for the development of postsurgical neuropathic pain (reviewed in Brennan and Kehlet, 2005). Experimental and clinical evidences suggest that extended duration of complete nerve blockade combined with drugs to prevent glial activation will be needed to prevent postsurgical neuropathic pain. Clearly, novel strategies targeting neuronal and nonneuronal mechanisms need to be explored to better manage postsurgical pain.

Considering the complexity of the laboratory animal environment and the fact that there are few clinically tested regimes for managing chronic pain in animals, making specific treatment

recommendations would not be productive. Therefore, the following section and references Amir et al. (2006), Backonja et al. (2006), Chevlen et al. (2005), Leo (2006), and Schnitzer (2006) are intended to serve as guidelines for treatment. Veterinary-specific options for treating chronic pain (osteoarthritis, cancer, oral) may be found in Beckman (2006), Flecknell (2001), Lester and Gaynor (2000), and McLaughlin (2000). Doses and additional information for many of the drugs described may be found in Gaynor and Muir (2002) and Plumb (1999).

A. Ion Channel Modulators

1. Sodium (Na) Channel Blockers

a. Lidocaine, mexiletine

Na channel blockers suppress spontaneous ectopic discharges at drug concentrations that do not inhibit normal impulse generation and propagation. As a result, these drugs can relieve chronic neuropathic pain with a high therapeutic index. Intravenous lidocaine and 5% lidocaine patches (first drug FDA-approved for postherpetic neuralgia) have both been shown efficacious for the treatment of neuropathic pain in people. Intravenous lidocaine has been shown to relieve neuropathic pain in rat (infusion) and people (bolus, infusion, and bolus plus infusion) for 3–21 days (Chaplan et al., 1995; Mao and Chen, 2000). Using published doses and infusion rates, lidocaine may prove effective in other species as well. Although the pharmacokinetics of 5% lidocaine patch has been reported in dog (Weiland et al., 2006) and appears to be well tolerated, no clinical studies have been performed. Mexiletine is an oral congener of lidocaine demonstrating variable success in human clinical trials (Duby et al., 2004; Kingery, 1997). Some evidence suggests that a positive test with IV lidocaine predicts pain relief with mexiletine (Galer et al., 1996). Although used as an antiarrhythmic in veterinary medicine, mexiletine’s efficacy for neuropathic pain in animals is unknown.

b. Phenytoin

The anticonvulsant phenytoin is a classic neuroactive drug reportedly effective in treating neuropathic pain in humans (reviewed in Markman and Dworkin, 2006) but with variable efficacy in experimental rat models (Hunter et al., 1997; Ko et al., 2006). Phenytoin’s mechanism of action appears to be Na-channel blockade and inhibition of presynaptic glutamate release (Yaari et al., 1986). Although used as an anticonvulsant, its utility for managing chronic pain in animals is unexplored. Excessive sedation, ataxia, hepatocellular toxicity, and potential drug interactions may be limiting factors for its use.

2. Calcium Channel Blockers

Gabapentin and pregabalin are GABA analogs that bind to the $\alpha 2\beta$ subunit of N-type calcium channels, a subunit

upregulated by tissue inflammation and nerve injury. Although their definitive mechanism of action is unknown, gabapentin and pregabalin are postulated to inhibit pronociceptive neurotransmitter release from sensory nerve terminals (reviewed in McGivern, 2006). Gabapentin (and likely pregabalin) does not have any intrinsic analgesic activity and can be pronociceptive in the absence of clinical or pathologic pain (Gaynor and Muir, 2002). Both drugs are labeled for the treatment of a variety of neuropathic pain syndromes in people with pregabalin having improved potency and superior bioavailability. Experimental studies in rat and mouse demonstrate that gabapentin and pregabalin may be viable drugs for treating neuropathic pain in animals (Field et al., 1999; Laughlin et al., 2002; Peters et al., 2005; Walczak and Beaulieu, 2006; Walczak et al., 2006) and may be able to prevent the development of neuropathic pain if administered before nerve injury (Yasuda et al., 2005). Both drugs may be used for monotherapy or combined with other medications (Gilron et al., 2006), and some evidence suggests that gabapentin may be more effective when combined with morphine (Baillie and Power, 2005).

B. Tricyclic Antidepressants

Tricyclic antidepressants (TCA) are considered first-line drugs for the treatment of neuropathic pain and are used to treat a wide variety of chronic pain syndromes. Both experimental and clinical evidences indicate that these drugs have analgesic activity independent of their mood-altering properties (Fishbain et al., 2000; Max et al., 1987).

Amitriptyline is the gold standard for analgesic antidepressants. Together with its metabolite nortriptyline, this drug has the best-documented efficacy in the treatment of neuropathic and many nonneuropathic pain syndromes (Bryson and Wilde, 1996; Saarto and Wiffen, 2005). Amitriptyline's analgesic mechanism of action has been ascribed to enhancing the activity of antinociceptive bulbospinal pathways by decreasing reuptake of serotonin and norepinephrine at either spinal terminals or the brain stem (reviewed in Esser and Sawynok, 1999). Additional central and peripheral mechanisms for amitriptyline analgesia have been proposed. These include modulating central cytokine release and function (Obuchowicz et al., 2006; Reynolds et al., 2004) and, peripheral analgesia through blockade of tetrodotoxin-resistant Na channels (Brau et al., 2001) and reduced adenosine reuptake (Lynch et al., 2005; Sawynok et al., 1999, 2005).

Amitriptyline is used to treat idiopathic feline lower urinary tract disease (Chew et al., 1998) and may be effective for other chronic pain syndromes in animals. Experimentally, amitriptyline has been shown to be pro- and antinociceptive or nonefficacious depending on the model used, route of administration, and behavioral endpoint (Beyreuther et al., 2006; Esser et al., 2001; LaBuda and Little, 2005; Walczak et al., 2005, 2006).

C. Opioids

As a class, opioids are some of the most potent and controversial drugs available for the treatment of chronic pain regardless of etiology. Opioids have both central and peripheral effects mediated by complex interactions with mu, kappa, and delta receptors. Requisite dosing intervals (q 2–6 hours) make most current opioid formulations impractical for the management of chronic pain in laboratory animals. Patch, implant, or depo formulations (fentanyl and buprenorphine) (Kleppner et al., 2006) may be useful, and the development of liposome-encapsulated oxycodone holds great promise as well (Smith et al., 2003). Oral sustained-release preparations (morphine oxycodone, buprenorphine, dihydrocodeine) are available but may be poorly and erratically absorbed (KuKanich et al., 2005).

Opioids are most effective in treating inflammatory and malignancy-related chronic pain but questions persist about their use in the treatment of neuropathic pain. Although effective in many neuropathic conditions, their usefulness in central pain is still equivocal (reviewed in Katz and Benoit, 2005). Rodent studies indicate that buprenorphine (Christoph et al., 2005; Kouya et al., 2002), morphine (Decosterd et al., 2004; Walczak et al., 2005; Yasuda et al., 2005), and fentanyl (Stewart and Martin, 2003; Womer and Shannon, 2000; Zurek et al., 2001) are effective in the treatment of neuropathic pain. As with TCAs, opioid efficacy varies in experimental studies by drug, model, route of administration, and dependent measure (reviewed in Martin and Eisenach, 2001).

In human medicine, transdermal fentanyl is recommended for and shown to be efficacious in the management of osteoarthritis and other conditions that do not respond well to nonopioid analgesics (Babic-Naglic et al., 2002; Langford et al., 2006; Le Loet et al., 2005). Transdermal fentanyl has demonstrated use for acute pain in cat, dog, and pig (Harvey-Clark et al., 2000; Hofmeister and Egger, 2004; Lafuente et al., 2005; Malavasi et al., 2006; Romans et al., 2005), and the author's institution uses fentanyl patches for small ruminants and rabbits as well. Although cost, application, and disposal concerns may be limiting factors, there is no clinical or experimental evidence to contraindicate the use of transdermal fentanyl for chronic pain in animals. To the author's knowledge, the clinical use of transdermal buprenorphine has yet to be evaluated in species other than humans.

Excepting experimental rodent and cat models, no studies have evaluated the effects of chronic opioid treatment in animals. Tolerance, withdrawal, sleep disturbances, and altered function of primary visual cortical neurons have been demonstrated with chronic morphine administration in cats (Borrell, 1975 #1; De Andres and Caballero, 1989; Guaza, 1979 #2; He, 2005a #501; He, 2005b #500; Jhamandas, 1984 #3). However, extrapolating these results to clinical use may not be appropriate since all the cited studies employed supra-analgesic doses of morphine.

D. Corticosteroids

Corticosteroids as a group may be used as primary or adjunctive treatment for chronic pain. In people, corticosteroids are used as adjuncts in the management of cancer-related chronic pain (Lussier, 2004 #508) and may be a primary treatment for some neuropathic pain syndromes (Dabby et al., 2006; Kingery, 1997). Experimental models show dichotomous data with respect to glucocorticoids and neuropathic pain. Several studies suggest that glucocorticoids can inhibit and reverse neuropathic pain, possibly by inhibiting glial activation (Takeda et al., 2004) or central cytokine production (Xie et al., 2006). Others show upregulation of glucocorticoid receptors in response to induced neuropathic pain and a role for glucocorticoid receptor antagonists as treatment (Takasaki et al., 2005; Wang et al., 2004). When used judiciously, experimental study in *Macaca nemestrina* (Leverenz et al., 1999) and clinical use in cat and dog demonstrate that corticosteroids can be used for months with mild adverse effects (Cizinauskas et al., 2000; Preziosi et al., 2003).

E. Nonsteroidal Anti-Inflammatory Drugs

Nonsteroidal anti-inflammatory drugs (NSAIDs) are the most commonly used analgesic drugs in veterinary medicine. They also have the distinction of being the only medications with documented clinical efficacy and safety in the treatment of chronic pain (osteoarthritis). The pharmacology and toxicology of NSAIDs are discussed in Chapter 4. NSAIDs are primarily indicated for the treatment of pain arising from inflammatory musculoskeletal disease and osteoarthritis. Although not front-line drugs or universally effective, NSAIDs can have a place in the management of chronic neuropathic or cancer pain (Robertson, 2005; Suyama et al., 2004) and can be synergistic with opioids. Other advantages of NSAIDs include the commercial availability of a wide variety of drugs in enteral and parenteral forms, which are useful in numerous species. Initial drug selection is usually based on clinical experience, and is not always effective. For reasons unknown, animals (including people) may respond to one NSAID but not another, necessitating empirical trials to find an effective drug. For example, an arthritic 30-year-old stump-tail macaque (*Macacca arctoides*), previously well managed with celecoxib, has been successfully treated by the author using etodolac (5 mg/kg PO, SID) after an unsuccessful trial with meloxicam. To avoid toxicity or potentially fatal effects with long-term NSAID use, it is critical to use the lowest possible effective dose, never exceed approved or published dosage, and never initiate use of another NSAID or corticosteroid without an appropriate washout time (5–10 days) between drugs (Boston et al., 2003; KuKanich et al., 2005; Lascelles et al., 2005a, 2005b; Nakagawa et al., 2005; Reed, 2002). Periodic monitoring for fecal occult blood and evaluation of complete blood count (CBC) and serum chemistry are prudent during chronic NSAID treatment as well.

For chronic use (weeks to years), a COX-2 selective NSAID may afford a greater margin of safety over a nonselective drug with respect to gastrointestinal and renal toxicity. However, all NSAIDs have ulcerogenic and nephrotoxic potential, and COX-2 selectives have been postulated to be prothrombotic, atherogenic, and hypertensive (Bolten, 2006; Krotz et al., 2005; Wang et al., 2005; Weir et al., 2003).

In the author's experience, meloxicam, ibuprofen, and etodolac have been safe and effective for long-term use (weeks to years) in rhesus and stump-tail macaques and may be appropriate for other nonhuman primates. Dogs are afforded a wide selection of NSAIDs and benefit from a fair body of experimental and clinical studies regarding their safety and efficacy. Although other NSAIDs are labeled for use in dog, carprofen, meloxicam, deracoxib, etodolac, and firocoxib are labeled for long-term use. NSAID use in proper form for reference to the species is singular cat is problematic due to the substantial potential for toxicity and lack of (as in none) NSAIDs labeled for chronic administration in this species. However, two sources have described regimes for long-term meloxicam treatment in cats (Gaynor and Muir, 2002; Robertson, 2005).

At the author's institution, meloxicam, carprofen, and ibuprofen are used for acute pain in rat and mouse. The effect of long-term PO use at recommended doses in these species has not been evaluated (see <http://info.med.yale.edu/iacuc/policies/postopanalgesia.html>). High doses of meloxicam (≥ 3.75 mg/kg) and ibuprofen (≥ 25 mg/kg) are predictably ulcerogenic in several rodent models (Bonabello et al., 2003; Khan and Akhter, 2005). Some experimental evidence suggests that COX-2 selective agents have reduced ulcerogenic potential in rodents and may be safe for long-term use at recommended doses (Brown et al., 2000; Rainsford, 1987). A wide variety of NSAIDs are used acutely in ruminants, swine, lagomorphs, birds, and rodents. To the author's knowledge, the long-term (weeks to years) administration of NSAIDs in these species has not been evaluated.

F. NMDA Receptor Antagonists

Ketamine, dextromethorphan, and amantadine are NMDA receptor (NMDAR) antagonists used in veterinary medicine that appear to have a role in the management of chronic pain (Fisher et al., 2000). NMDAR antagonists can inhibit the development and maintenance of central sensitization and are synergistic with opioids and NSAIDs (Petrenko et al., 2003; Visser and Schug, 2006). Thus, the primary indication for the use of NMDAR antagonists appears to be adjunctive or part of multimodal therapy with the goal of controlling central sensitization. Regrettably, their use is often limited by difficulty in administration and/or unacceptable adverse effects. Ketamine is one of the most potent NMDAR antagonists available and one case report describes its use in the management of postamputation clinical signs in a cat (O'Hagan, 2006). Unfortunately, ketamine is rather difficult to use in the management of chronic

pain since this application generally requires infusion protocols. Dextromethorphan has been used for years as an antitussive and doses of 2 mg/kg BID PO appear to be well tolerated in dog over 2 weeks (Dodman et al., 2004). However, the pharmacokinetic profile and adverse effects of dextromethorphan may limit its utility in the management of chronic pain (Kukanich and Papich, 2004). Amantadine is another oral form of NMDAR antagonist suggested for treating chronic pain in dog and cat (Gaynor and Muir, 2002). None of the NMDAR antagonists have been evaluated in veterinary clinical trials for the management of chronic pain. For an excellent review of NMDAR antagonists including referenced doses see Pozzi et al. (2006).

REFERENCES

- Aguilera, G., Jessop, D.S., Harbuz, M.S., Kiss, A., and Lightman, S.L. (1997). Differential regulation of hypothalamic pituitary corticotropin releasing hormone receptors during development of adjuvant-induced arthritis in the rat. *J. Endocrinol.* **153**(2), 185–191.
- Amir, R., Argoff, C.E., Bennett, G.J., Cummins, T.R., Durieux, M.E., Gerner, P., Gold, M.S., Porreca, F., and Strichartz, G.R. (2006). The role of sodium channels in chronic inflammatory and neuropathic pain. *J. Pain* **7**(5 Suppl. 3), S1–S29.
- Apkarian, A.V., Sosa, Y., Krauss, B.R., Thomas, P.S., Fredrickson, B.E., Levy, R.E., Harden, R.N., and Chialvo, D.R. (2004). Chronic pain patients are impaired on an emotional decision-making task. *Pain* **108**(1–2), 129–136.
- Araque, A. (2006). Astrocyte-neuron signaling in the brain—Implications for disease. *Curr. Opin. Investig. Drugs* **7**(7), 619–624.
- Araque, A., Parpura, V., Sanzgiri, R.P., and Haydon, P.G. (1999a). Tripartite synapses: Glia, the unacknowledged partner. *Trends Neurosci.* **22**(5), 208–215.
- Araque, A., Sanzgiri, R.P., Parpura, V., and Haydon, P.G. (1999b). Astrocyte-induced modulation of synaptic transmission. *Can. J. Physiol. Pharmacol.* **77**(9), 699–706.
- Babic-Naglic, D., Jajic, Z., Gnjidic, Z., and Stambuk, B. (2002). Treatment of chronic pain—Use of transdermal fentanyl (Durogesic TTS). *Reumatizam* **49**(2), 33–37.
- Backonja, M.M., Irving, G., and Argoff, C. (2006). Rational multidrug therapy in the treatment of neuropathic pain. *Curr. Pain Headache Rep.* **10**(1), 34–38.
- Baillie, J.K., and Power, I. (2005). Morphine, gabapentin, or their combination for neuropathic pain. *N. Engl. J. Med.* **352**(25), 2650–2651 (author reply 2650–2651).
- Beckman, B.W. (2006). Pathophysiology and management of surgical and chronic oral pain in dogs and cats. *J. Vet. Dent.* **23**(1), 50–60.
- Bendele, A.M. (2001). Animal models of osteoarthritis. *J. Musculoskelet. Neuronal Interact.* **1**(4), 363–376.
- Beyreuther, B., Callizot, N., and Stohr, T. (2006). Antinociceptive efficacy of lacosamide in a rat model for painful diabetic neuropathy. *Eur. J. Pharmacol.* **539**(1–2), 64–70.
- Black, A., and Lane, M.A. (2002). Nonhuman primate models of skeletal and reproductive aging. *Gerontology* **48**(2), 72–80.
- Blackburn-Munro, G. (2004). Hypothalamo-pituitary-adrenal axis dysfunction as a contributory factor to chronic pain and depression. *Curr. Pain Headache Rep.* **8**(2), 116–124.
- Blackburn-Munro, G., and Blackburn-Munro, R.E. (2001). Chronic pain, chronic stress and depression: Coincidence or consequence? *J. Neuroendocrinol.* **13**(12), 1009–1023.
- Bolten, W.W. (2006). Problem of the atherothrombotic potential of non-steroidal anti-inflammatory drugs. *Ann. Rheum. Dis.* **65**(1), 7–13.
- Bomholt, S.F., Harbuz, M.S., Blackburn-Munro, G., and Blackburn-Munro, R.E. (2004). Involvement and role of the hypothalamo-pituitary-adrenal (HPA) stress axis in animal models of chronic pain and inflammation. *Stress* **7**(1), 1–14.
- Bomholt, S.F., Mikkelsen, J.D., and Blackburn-Munro, G. (2005). Normal hypothalamo-pituitary-adrenal axis function in a rat model of peripheral neuropathic pain. *Brain Res.* **1044**(2), 216–226.
- Bonabello, A., Galmozzi, M.R., Canaparo, R., Isaia, G.C., Serpe, L., Muntoni, E., and Zara, G.P. (2003). Dexibuprofen (S(+)-isomer ibuprofen) reduces gastric damage and improves analgesic and antiinflammatory effects in rodents. *Anesth. Analg.* **97**(2), 402–408, Table of Contents.
- Bonica, J. (1953). “The Management of Pain.” Lea and Febiger, Philadelphia, PA.
- Boston, S.E., Moens, N.M., Kruth, S.A., and Southorn, E.P. (2003). Endoscopic evaluation of the gastroduodenal mucosa to determine the safety of short-term concurrent administration of meloxicam and dexamethasone in healthy dogs. *Am. J. Vet. Res.* **64**(11), 1369–1375.
- Brau, M.E., Dreimann, M., Olschewski, A., Vogel, W., and Hempelmann, G. (2001). Effect of drugs used for neuropathic pain management on tetrodotoxin-resistant Na(+) currents in rat sensory neurons. *Anesthesiology* **94**(1), 137–144.
- Breen, J. (2002). Transitions in the concept of chronic pain. *Adv. Nurs. Sci.* **24**(4), 48–59.
- Brennan, T.J., and Kehlet, H. (2005). Preventive analgesia to reduce wound hyperalgesia and persistent postsurgical pain: Not an easy path. *Anesthesiology* **103**(4), 681–683.
- Brenowitz, G.L. (1983). Timecourse for receptive field plasticity following spinal cord hemisection. *Brain Res.* **279**(1–2), 250–253.
- Brown, W.A., Skinner, S.A., Malcontenti-Wilson, C., Misajon, A., DeJong, T., Voggiagis, D., and O’Brien, P.E. (2000). Non-steroidal anti-inflammatory drugs with different cyclooxygenase inhibitory profiles that prevent aberrant crypt foci formation but vary in acute gastrotoxicity in a rat model. *J. Gastroenterol. Hepatol.* **15**(12), 1386–1392.
- Bryson, H.M., and Wilde, M.I. (1996). Amitriptyline. A review of its pharmacological properties and therapeutic use in chronic pain states. *Drugs Aging* **8**(6), 459–476.
- Cain, D.M., Wacnik, P.W., Turner, M., Wendelschafer-Crabb, G., Kennedy, W.R., Wilcox, G.L., and Simone, D.A. (2001). Functional interactions between tumor and peripheral nerve: Changes in excitability and morphology of primary afferent fibers in a murine model of cancer pain. *J. Neurosci.* **21**(23), 9367–9376.
- Calza, L., Pozza, M., Arletti, R., Manzini, E., and Hokfelt, T. (2000). Long-lasting regulation of galanin, opioid, and other peptides in dorsal root ganglia and spinal cord during experimental polyarthritis. *Exp. Neurol.* **164**(2), 333–343.
- Calza, L., Pozza, M., Zanni, M., Manzini, C.U., Manzini, E., and Hokfelt, T. (1998). Peptide plasticity in primary sensory neurons and spinal cord during adjuvant-induced arthritis in the rat: An immunocytochemical and in situ hybridization study. *Neuroscience* **82**(2), 575–589.
- Carlson, C.S., Loeser, R.F., Purser, C.B., Gardin, J.F., and Jerome, C.P. (1996). Osteoarthritis in cynomolgus macaques. III: Effects of age, gender, and subchondral bone thickness on the severity of disease. *J. Bone Miner. Res.* **11**(9), 1209–1217.
- Chaplan, S.R., Bach, F.W., Shafer, S.L., and Yaksh, T.L. (1995). Prolonged alleviation of tactile allodynia by intravenous lidocaine in neuropathic rats. *Anesthesiology* **83**(4), 775–785.
- Chevlen, E., Davis, P.S., and Rhiner, M. (2005). From mechanisms to management: Translating the neuropathic pain consensus recommendations into clinical practice. *J. Am. Acad. Nurse Pract.* **17**(6 Suppl.), 3–17 (quiz 18).
- Chew, D.J., Buffington, C.A., Kendall, M.S., DiBartola, S.P., and Woodworth, B.E. (1998). Amitriptyline treatment for severe recurrent idiopathic cystitis in cats. *J. Am. Vet. Med. Assoc.* **213**(9), 1282–1286.
- Chong, M.S., and Bajwa, Z.H. (2003). Diagnosis and treatment of neuropathic pain. *J. Pain Symptom Manage.* **25**(5 Suppl.), S4–S11.
- Christoph, T., Kogel, B., Schiene, K., Meen, M., De Vry, J., and Friderichs, E. (2005). Broad analgesic profile of buprenorphine in rodent models of acute and chronic pain. *Eur. J. Pharmacol.* **507**(1–3), 87–98.

- Cizinauskas, S., Jaggy, A., and Tipold, A. (2000). Long-term treatment of dogs with steroid-responsive meningitis-arteritis: Clinical, laboratory and therapeutic results. *J. Small Anim. Pract.* **41**(7), 295–301.
- Clarke, S.P., and Bennett, D. (2006). Feline osteoarthritis: A prospective study of 28 cases. *J. Small Anim. Pract.* **47**(8), 439–445.
- Cruccu, G., and Truini, A. (2006). Assessment of neuropathic pain. *Neurol. Sci.* **27**(Suppl. 4), s288–s290.
- Dabby, R., Gilad, R., Sadeh, M., Lampl, Y., and Waternberg, N. (2006). Acute steroid responsive small-fiber sensory neuropathy: A new entity? *J. Peripher. Nerv. Syst.*, **11**(1), 47–52.
- De Andres, I., and Caballero, A. (1989). Chronic morphine administration in cats: Effects on sleep and EEG. *Pharmacol. Biochem. Behav.* **32**(2), 519–526.
- Decosterd, I., Allchorne, A., and Woolf, C.J. (2004). Differential analgesic sensitivity of two distinct neuropathic pain models. *Anesth. Analg.* **99**(2), 457–463, Table of Contents.
- DeLeo, J.A., and Rutkowski, M.D. (2000). Gender differences in rat neuropathic pain sensitivity is dependent on strain. *Neurosci. Lett.* **282**(3), 197–199.
- DeLeo, J.A., Tanga, F.Y., and Tawfik, V.L. (2004). Neuroimmune activation and neuroinflammation in chronic pain and opioid tolerance/hyperalgesia. *Neuroscientist* **10**(1), 40–52.
- DeLeo, J.A., and Yezierski, R.P. (2001). The role of neuroinflammation and neuroimmune activation in persistent pain. *Pain* **90**(1–2), 1–6.
- Dodman, N.H., Shuster, L., Nesbitt, G., Weissman, A., Lo, W.Y., Chang, W.W., and Cottam, N. (2004). The use of dextromethorphan to treat repetitive self-directed scratching, biting, or chewing in dogs with allergic dermatitis. *J. Vet. Pharmacol. Ther.* **27**(2), 99–104.
- Dranovsky, A., and Hen, R. (2006). Hippocampal neurogenesis: Regulation by stress and antidepressants. *Biol. Psychiatry* **59**(12), 1136–1143.
- Duby, J.J., Campbell, R.K., Setter, S.M., White, J.R., and Rasmussen, K.A. (2004). Diabetic neuropathy: An intensive review. *Am. J. Health Syst. Pharm.* **61**(2), 160–173 (quiz 175–176).
- Duncan, I.J., Beatty, E.R., Hocking, P.M., and Duff, S.R. (1991). Assessment of pain associated with degenerative hip disorders in adult male turkeys. *Res. Vet. Sci.* **50**(2), 200–203.
- Duric, V., and McCarron, K.E. (2006). Persistent pain produces stress-like alterations in hippocampal neurogenesis and gene expression. *J. Pain* **7**(8), 544–555.
- Dworkin, R.H., and Gitlin, M.J. (1991). Clinical aspects of depression in chronic pain patients. *Clin. J. Pain* **7**(2), 79–94.
- Eddleston, M., and Mucke, L. (1993). Molecular profile of reactive astrocytes—implications for their role in neurologic disease. *Neuroscience* **54**(1), 15–36.
- Esser, M.J., Chase, T., Allen, G.V., and Sawynok, J. (2001). Chronic administration of amitriptyline and caffeine in a rat model of neuropathic pain: Multiple interactions. *Eur. J. Pharmacol.* **430**(2–3), 211–218.
- Esser, M.J., and Sawynok, J. (1999). Acute amitriptyline in a rat model of neuropathic pain: Differential symptom and route effects. *Pain* **80**(3), 643–653.
- Field, M.J., McCleary, S., Hughes, J., and Singh, L. (1999). Gabapentin and pregabalin, but not morphine and amitriptyline, block both static and dynamic components of mechanical allodynia induced by streptozocin in the rat. *Pain* **80**(1–2), 391–398.
- Fishbain, D.A., Cutler, R., Rosomoff, H.L., and Rosomoff, R.S. (2000). Evidence-based data from animal and human experimental studies on pain relief with antidepressants: A structured review. *Pain Med.* **1**(4), 310–316.
- Fisher, K., Coderre, T.J., and Hagen, N.A. (2000). Targeting the N-methyl-D-aspartate receptor for chronic pain management. Preclinical animal studies, recent clinical experience and future research directions. *J. Pain Symptom Manage.* **20**(5), 358–373.
- Flecknell, P.A. (2001). Analgesia of small mammals. *Vet. Clin. North Am. Exot. Anim. Pract.* **4**(1), 47–56, vi.
- Gaab, J., Baumann, S., Budnoik, A., Gmunder, H., Hottinger, N., and Ehlert, U. (2005). Reduced reactivity and enhanced negative feedback sensitivity of the hypothalamus–pituitary–adrenal axis in chronic whiplash-associated disorder. *Pain* **119**(1–3), 219–224.
- Galer, B.S., Harle, J., and Rowbotham, M.C. (1996). Response to intravenous lidocaine infusion predicts subsequent response to oral mexiletine: A prospective study. *J. Pain Symptom Manage.* **12**(3), 161–167.
- Garrison, C.J., Dougherty, P.M., and Carlton, S.M. (1994). GFAP expression in lumbar spinal cord of naive and neuropathic rats treated with MK-801. *Exp. Neurol.* **129**(2), 237–243.
- Gaumond, I., Arsenault, P., and Marchand, S. (2005). Specificity of female and male sex hormones on excitatory and inhibitory phases of formalin-induced nociceptive responses. *Brain Res.* **1052**(1), 105–111.
- Gaynor, J., and Muir, W. (2002). “Handbook of Veterinary Pain Management.” Mosby, St. Louis, MO.
- Gilron, I., Watson, C.P., Cahill, C.M., and Moulin, D.E. (2006). Neuropathic pain: A practical guide for the clinician. *Can. Med. Assoc. J.* **175**(3), 265–275.
- Gordh, T., Chu, H., and Sharma, H.S. (2006). Spinal nerve lesion alters blood-spinal cord barrier function and activates astrocytes in the rat. *Pain* **124**(1–2), 211–221.
- Grachev, I.D., Fredrickson, B.E., and Apkarian, A.V. (2000). Abnormal brain chemistry in chronic back pain: An in vivo proton magnetic resonance spectroscopy study. *Pain* **89**(1), 7–18.
- Grelik, C., Bennett, G.J., and Ribeiro-da-Silva, A. (2005). Autonomic fibre sprouting and changes in nociceptive sensory innervation in the rat lower lip skin following chronic constriction injury. *Eur. J. Neurosci.* **21**(9), 2475–2487.
- Hains, B.C., Willis, W.D., and Hulsebosch, C.E. (2003). Temporal plasticity of dorsal horn somatosensory neurons after acute and chronic spinal cord hemisection in rat. *Brain Res.* **970**(1–2), 238–241.
- Hansson, P. (2002). Neuropathic pain: Clinical characteristics and diagnostic workup. *Eur. J. Pain* **6**(Suppl. A), 47–50.
- Harbuz, M.S., Conde, G.L., Marti, O., Lightman, S.L., and Jessop, D.S. (1997). The hypothalamic–pituitary–adrenal axis in autoimmunity. *Ann. N. Y. Acad. Sci.* **823**, 214–224.
- Harvey-Clark, C.J., Gillespie, K., and Riggs, K.W. (2000). Transdermal fentanyl compared with parenteral buprenorphine in post-surgical pain in swine: A case study. *Lab. Anim.* **34**(4), 386–398.
- Herr, K. (2004). Neuropathic pain: A guide to comprehensive assessment. *Pain Manag. Nurs.* **5**(4 Suppl. 1), 9–18.
- Herzberg, U., Brown, D.R., Mullett, M.A., and Beitz, A.J. (1996a). Increased delayed type hypersensitivity in rats subjected to unilateral mononeuropathy is mediated by neurokinin-1 receptors. *J. Neuroimmunol.* **65**(2), 119–24.
- Herzberg, U., Murtaugh, M., and Beitz, A.J. (1994). Chronic pain and immunity: Mononeuropathy alters immune responses in rats. *Pain* **59**(2), 219–225.
- Herzberg, U., Murtaugh, M.P., Carroll, D., and Beitz, A.J. (1996b). Spinal cord NMDA receptors modulate peripheral immune responses and spinal cord c-fos expression after immune challenge in rats subjected to unilateral mononeuropathy. *J. Neurosci.* **16**(2), 730–743.
- Herzberg, U., and Sagen, J. (2001). Peripheral nerve exposure to HIV viral envelope protein gp120 induces neuropathic pain and spinal gliosis. *J. Neuroimmunol.* **116**(1), 29–39.
- Hjelm-Bjorkman, A.K., Kuusela, E., Liman, A., Markkola, A., Saarto, E., Hutunnen, P., Leppaluoto, J., Tulamo, R.M., and Raekallio, M. (2003). Evaluation of methods for assessment of pain associated with chronic osteoarthritis in dogs. *J. Am. Vet. Med. Assoc.* **222**(11), 1552–1558.
- Hofmeister, E.H., and Egger, C.M. (2004). Transdermal fentanyl patches in small animals. *J. Am. Anim. Hosp. Assoc.* **40**(6), 468–478.
- Hunter, J.C., Gogas, K.R., Hedley, L.R., Jacobson, L.O., Kassotakis, L., Thompson, J., and Fontana, D.J. (1997). The effect of novel anti-epileptic drugs in rat experimental models of acute and chronic pain. *Eur. J. Pharmacol.* **324**(2–3), 153–160.
- Iwata, K., Fukuoka, T., Kondo, E., Tsuboi, Y., Tashiro, A., Noguchi, K., Masuda, Y., Morimoto, T., and Kanda, K. (2002). Plastic changes in nociceptive transmission of the rat spinal cord with advancing age. *J. Neurophysiol.* **87**(2), 1086–1093.
- Jabbur, S.J., and Saade, N.E. (1999). From electrical wiring to plastic neurons: Evolving approaches to the study of pain. *Pain* **82**(Suppl. 6), S87–S92.

- Jensen, T.S., and Baron, R. (2003). Translation of symptoms and signs into mechanisms in neuropathic pain. *Pain* **102**(1–2), 1–8.
- Ji, R.R., and Woolf, C.J. (2001). Neuronal plasticity and signal transduction in nociceptive neurons: Implications for the initiation and maintenance of pathological pain. *Neurobiol. Dis.* **8**(1), 1–10.
- Katz, N., and Benoit, C. (2005). Opioids for neuropathic pain. *Curr. Pain Headache Rep.* **9**(3), 153–160.
- Kehlet, H., Jensen, T.S., and Woolf, C.J. (2006). Persistent postsurgical pain: Risk factors and prevention. *Lancet* **367**(9522), 1618–1625.
- Khan, M.S., and Akhter, M. (2005). Synthesis, pharmacological activity and hydrolytic behavior of glyceride prodrugs of ibuprofen. *Eur. J. Med. Chem.* **40**(4), 371–376.
- Kingery, W.S. (1997). A critical review of controlled clinical trials for peripheral neuropathic pain and complex regional pain syndromes. *Pain* **73**(2), 123–139.
- Kingery, W.S., and Vallin, J.A. (1989). The development of chronic mechanical hyperalgesia, autotomy and collateral sprouting following sciatic nerve section in rat. *Pain* **38**(3), 321–332.
- Kitagawa, J., Kanda, K., Sugiura, M., Tsuboi, Y., Ogawa, A., Shimizu, K., Koyama, N., Kamo, H., Watanabe, T., Ren, K., and Iwata, K. (2005). Effect of chronic inflammation on dorsal horn nociceptive neurons in aged rats. *J. Neurophysiol.* **93**(6), 3594–3604.
- Kleppner, S.R., Patel, R., McDonough, J., and Costantini, L.C. (2006). In-vitro and in-vivo characterization of a buprenorphine delivery system. *J. Pharm. Pharmacol.* **58**(3), 295–302.
- Ko, S.H., Jochowitz, N., Lenkowski, P.W., Batts, T.W., Davis, G.C., Martin, W.J., Brown, M.L., and Patel, M.K. (2006). Reversal of neuropathic pain by alpha-hydroxyphenylamide: A novel sodium channel antagonist. *Neuropharmacology* **50**(7), 865–873.
- Kouya, P.F., Hao, J.X., and Xu, X.J. (2002). Buprenorphine alleviates neuropathic pain-like behaviors in rats after spinal cord and peripheral nerve injury. *Eur. J. Pharmacol.* **450**(1), 49–53.
- Krotz, F., Schiele, T.M., Klauss, V., and Sohn, H.Y. (2005). Selective COX-2 inhibitors and risk of myocardial infarction. *J. Vasc. Res.* **42**(4), 312–324.
- KuKanich, B., Lascelles, B.D., and Papich, M.G. (2005). Pharmacokinetics of morphine and plasma concentrations of morphine-6-glucuronide following morphine administration to dogs. *J. Vet. Pharmacol. Ther.* **28**(4), 371–376.
- Kukanich, B., and Papich, M.G. (2004). Plasma profile and pharmacokinetics of dextromethorphan after intravenous and oral administration in healthy dogs. *J. Vet. Pharmacol. Ther.* **27**(5), 337–341.
- LaBuda, C.J., and Little, P.J. (2005). Pharmacological evaluation of the selective spinal nerve ligation model of neuropathic pain in the rat. *J. Neurosci. Methods* **144**(2), 175–181.
- LaCroix-Fralish, M.L., Rutkowski, M.D., Weinstein, J.N., Mogil, J.S., and Deleo, J.A. (2005). The magnitude of mechanical allodynia in a rodent model of lumbar radiculopathy is dependent on strain and sex. *Spine* **30**(16), 1821–1827.
- Lafuente, M.P., Franch, J., Durall, I., Diaz-Bertrana, M.C., and Marquez, R.M. (2005). Comparison between meloxicam and transdermally administered fentanyl for treatment of postoperative pain in dogs undergoing osteotomy of the tibia and fibula and placement of a uniplanar external distraction device. *J. Am. Vet. Med. Assoc.* **227**(11), 1768–1774.
- Langford, R., McKenna, F., Ratcliffe, S., Vojtassak, J., and Richarz, U. (2006). Transdermal fentanyl for improvement of pain and functioning in osteoarthritis: A randomized, placebo-controlled trial. *Arthritis Rheum* **54**(6), 1829–1837.
- Lascelles, B.D., Blikslager, A.T., Fox, S.M., and Reece, D. (2005a). Gastrointestinal tract perforation in dogs treated with a selective cyclooxygenase-2 inhibitor: 29 cases (2002–2003). *J. Am. Vet. Med. Assoc.* **227**(7), 1112–1117.
- Lascelles, B.D., McFarland, J.M., and Swann, H. (2005b). Guidelines for safe and effective use of NSAIDs in dogs. *Vet. Ther.* **6**(3), 237–251.
- Laughlin, T.M., Tram, K.V., Wilcox, G.L., and Birnbaum, A.K. (2002). Comparison of antiepileptic drugs tiagabine, lamotrigine, and gabapentin in mouse models of acute, prolonged, and chronic nociception. *J. Pharmacol. Exp. Ther.* **302**(3), 1168–1175.
- Le Loet, X., Pavelka, K., and Richarz, U. (2005). Transdermal fentanyl for the treatment of pain caused by osteoarthritis of the knee or hip: An open, multicentre study. *BMC Musculoskelet. Disord.* **6**, 31.
- Leo, R.J. (2006). Treatment considerations in neuropathic pain. *Curr. Treat. Options Neurol.* **8**(5), 389–400.
- Lester, P., and Gaynor, J.S. (2000). Management of cancer pain. *Vet. Clin. North Am. Small Anim. Pract.* **30**(4), 951–966, ix.
- Leverenz, J.B., Wilkinson, C.W., Wamble, M., Corbin, S., Grabber, J.E., Raskind, M.A., and Peskind, E.R. (1999). Effect of chronic high-dose exogenous cortisol on hippocampal neuronal number in aged nonhuman primates. *J. Neurosci.* **19**(6), 2356–2361.
- Levy, D., and Zochodne, D.W. (2000). Increased mRNA expression of the B1 and B2 bradykinin receptors and antinociceptive effects of their antagonists in an animal model of neuropathic pain. *Pain* **86**(3), 265–271.
- Lim, K.K., Kessler, M.J., Pritzker, K.P., Turnquist, J.E., and Dieppe, P.A. (1996). Osteoarthritis of the hand in nonhuman primates: A clinical, radiographic, and skeletal survey of Cayo Santiago rhesus macaques. *J. Med. Primatol.* **25**(4), 301–308.
- Liu, Q.S., Xu, Q., Arcuino, G., Kang, J., and Nedergaard, M. (2004). Astrocyte-mediated activation of neuronal kainate receptors. *Proc. Natl. Acad. Sci. U S A* **101**(9), 3172–3177.
- Lovell, J.A., Novak, J.C., Stuesse, S.L., Cruce, W.L., and Crisp, T. (2000). Changes in spinal serotonin turnover mediate age-related differences in the behavioral manifestations of peripheral nerve injury. *Pharmacol. Biochem. Behav.* **66**(4), 873–878.
- Lynch, M.E., Clark, A.J., Sawynok, J., and Sullivan, M.J. (2005). Topical amitriptyline and ketamine in neuropathic pain syndromes: An open-label study. *J. Pain* **6**(10), 644–649.
- Malavasi, L.M., Nyman, G., Augustsson, H., Jacobson, M., and Jensen-Waern, M. (2006). Effects of epidural morphine and transdermal fentanyl analgesia on physiology and behaviour after abdominal surgery in pigs. *Lab. Anim.* **40**(1), 16–27.
- Mao, J., and Chen, L.L. (2000). Systemic lidocaine for neuropathic pain relief. *Pain* **87**(1), 7–17.
- Marcus, D.A. (2003). Gender differences in chronic pain in a treatment-seeking population. *J. Gen. Specif. Med.* **6**(4), 19–24.
- Markman, J.D., and Dworkin, R.H. (2006). Ion channel targets and treatment efficacy in neuropathic pain. *J. Pain* **7**(1 Suppl. 1), S38–S47.
- Martin, T.J., and Eisenach, J.C. (2001). Pharmacology of opioid and nonopioid analgesics in chronic pain states. *J. Pharmacol. Exp. Ther.* **299**(3), 811–817.
- Mathews, K.A. (2000). Pain assessment and general approach to management. *Vet. Clin. North Am. Small Anim. Pract.* **30**(4), 729–755, v.
- Max, M.B., Culnane, M., Schafer, S.C., Gracely, R.H., Walther, D.J., Smoller, B., and Dubner, R. (1987). Amitriptyline relieves diabetic neuropathy pain in patients with normal or depressed mood. *Neurology* **37**(4), 589–596.
- McBeth, J., Chiu, Y.H., Silman, A.J., Ray, D., Morriss, R., Dickens, C., Gupta, A., and Macfarlane, G.J. (2005). Hypothalamic-pituitary-adrenal stress axis function and the relationship with chronic widespread pain and its antecedents. *Arthritis Res. Ther.* **7**(5), R992–R1000.
- McGivern, J.G. (2006). Targeting N-type and T-type calcium channels for the treatment of pain. *Drug Discov. Today* **11**(5–6), 245–253.
- McLaughlin, R. (2000). Management of chronic osteoarthritic pain. *Vet. Clin. North Am. Small Anim. Pract.* **30**(4), 933–949, ix.
- Meana, M., Cho, R., and DesMeules, M. (2004). Chronic pain: The extra burden on Canadian women. *BMC Women's Health* **4**(Suppl. 1), S17.
- Merskey, H., and Bogduk, N. (1994). Classification of chronic pain. In “Descriptions of Chronic Pain Syndromes and Definitions of Pain Terms.” pp 1–215. IASP Press, Seattle.
- Mucke, L., and Eddleston, M. (1993). Astrocytes in infectious and immune-mediated diseases of the central nervous system. *FASEB J.* **7**(13), 1226–1232.
- Muir, W.W., III, Wiese, A.J., and Wittum, T.E. (2004). Prevalence and characteristics of pain in dogs and cats examined as outpatients at a veterinary teaching hospital. *J. Am. Vet. Med. Assoc.* **224**(9), 1459–1463.

- Muir, W.W., III, and Woolf, C.J. (2001). Mechanisms of pain and their therapeutic implications. *J. Am. Vet. Med. Assoc.* **219**(10), 1346–1356.
- Nakagawa, K., Yamagami, T., and Takemura, N. (2005). Hepatocellular toxicosis associated with the alternate administration of carprofen and meloxicam in a Siberian Husky. *J. Vet. Med. Sci.* **67**(10), 1051–1053.
- Narita, M., Kaneko, C., Miyoshi, K., Nagumo, Y., Kuzumaki, N., Nakajima, M., Nanjo, K., Matsuzawa, K., Yamazaki, M., and Suzuki, T. (2006a). Chronic pain induces anxiety with concomitant changes in opioidergic function in the amygdala. *Neuropsychopharmacology* **31**(4), 739–750.
- Narita, M., Kuzumaki, N., Kaneko, C., Hareyama, N., Miyatake, M., Shindo, K., Miyoshi, K., Nakajima, M., Nagumo, Y., Sato, F., Wachi, H., Seyama, Y., and Suzuki, T. (2006b). Chronic pain-induced emotional dysfunction is associated with astrogliosis due to cortical delta-opioid receptor dysfunction. *J. Neurochem.* **97**(5), 1369–1378.
- Novak, J.C., Lovell, J.A., Stuesse, S.L., Cruce, W.L.R., McBurney, D.L., and Crisp, T. (1999). Aging and neuropathic pain. *Brain Res.* **833**(2), 308–310.
- Obuchowicz, E., Kowalski, J., Labuzek, K., Krysiak, R., Pendzich, J., and Herman, Z.S. (2006). Amitriptyline and nortriptyline inhibit (interleukin) IL-1 release by rat mixed glial and microglial cell cultures. *Int. J. Neuropsychopharmacol.* **9**(1), 27–35.
- O'Hagan, B.J. (2006). Neuropathic pain in a cat post-amputation. *Aust. Vet. J.* **84**(3), 83–86.
- Orfila, F., Ferrer, M., Lamarca, R., Tebe, C., Domingo-Salvany, A., and Alonso, J. (2006). Gender differences in health-related quality of life among the elderly: The role of objective functional capacity and chronic conditions. *Soc. Sci. Med.*
- Perkins, F.M., and Kehlet, H. (2000). Chronic pain as an outcome of surgery. A review of predictive factors. *Anesthesiology* **93**(4), 1123–1133.
- Persellin, R.H., Kittinger, G.W., and Kendall, J.W. (1972). Adrenal response to experimental arthritis in the rat. *Am. J. Physiol.* **222**(6), 1545–1549.
- Peters, C.M., Ghilardi, J.R., Keyser, C.P., Kubota, K., Lindsay, T.H., Luger, N.M., Mach, D.B., Schwei, M.J., Sevcik, M.A., and Mantyh, P.W. (2005). Tumor-induced injury of primary afferent sensory nerve fibers in bone cancer pain. *Exp. Neurol.* **193**(1), 85–100.
- Petrenko, A.B., Yamakura, T., Baba, H., and Shimoji, K. (2003). The role of *N*-methyl-D-aspartate (NMDA) receptors in pain: A review. *Anesth. Analg.* **97**(4), 1108–1116.
- Plumb, D. (1999). "Veterinary Drug Handbook." Iowa State University Press, Ames.
- Pozzi, A., Muir, W.W., and Traverso, F. (2006). Prevention of central sensitization and pain by *N*-methyl-D-aspartate receptor antagonists. *J. Am. Vet. Med. Assoc.* **228**(1), 53–60.
- Preziosi, D.E., Goldschmidt, M.H., Greek, J.S., Jeffers, J.G., Shanley, K.S., Drobatz, K., and Mauldin, E.A. (2003). Feline pemphigus foliaceus: A retrospective analysis of 57 cases. *Vet. Dermatol.* **14**(6), 313–321.
- Raghavendra, V., Tanga, F.Y., and DeLeo, J.A. (2004). Complete Freund's adjuvant-induced peripheral inflammation evokes glial activation and proinflammatory cytokine expression in the CNS. *Eur. J. Neurosci.* **20**(2), 467–473 (doi:10.1111/j.1460-9568.2004.03514.x).
- Rainsford, K.D. (1987). Gastric ulcerogenicity of non-steroidal anti-inflammatory drugs in mice with mucosa sensitized by cholinomimetic treatment. *J. Pharm. Pharmacol.* **39**(8), 669–672.
- Ramer, M.S., and Bisby, M.A. (1998). Normal and injury-induced sympathetic innervation of rat dorsal root ganglia increases with age. *J. Comp. Neurol.* **394**(1), 38–47.
- Reed, S. (2002). Nonsteroidal anti-inflammatory drug-induced duodenal ulceration and perforation in a mature rottweiler. *Can. Vet. J.* **43**(12), 971–972.
- Reynolds, J.L., Ignatowski, T.A., Gallant, S., and Spengler, R.N. (2004). Amitriptyline administration transforms tumor necrosis factor- α regulation of norepinephrine release in the brain. *Brain Res.* **1023**(1), 112–120.
- Robertson, S.A. (2005). Managing pain in feline patients. *Vet. Clin. North Am. Small Anim. Pract.* **35**(1), 129–146.
- Romans, C.W., Gordon, W.J., Robinson, D.A., Evans, R., and Conzemius, M.G. (2005). Effect of postoperative analgesic protocol on limb function following onychectomy in cats. *J. Am. Vet. Med. Assoc.* **227**(1), 89–93.
- Romero-Sandoval, A., and Eisenach, J.C. (2006). Perineural clonidine reduces mechanical hypersensitivity and cytokine production in established nerve injury. *Anesthesiology* **104**(2), 351–355.
- Rothschild, B.M., Hong, N., and Turnquist, J.E. (1999). Skeletal survey of Cayo Santiago rhesus macaques: Osteoarthritis and articular plate excrescences. *Semin. Arthritis Rheum.* **29**(2), 100–111.
- Rustoen, T., Wahl, A.K., Hanestad, B.R., Lerdal, A., Paul, S., and Miaskowski, C. (2004). Gender differences in chronic pain—Findings from a population-based study of Norwegian adults. *Pain Manag. Nurs.* **5**(3), 105–117.
- Saarto, T., and Wiffen, P.J. (2005). Antidepressants for neuropathic pain. *Cochrane Database Syst. Rev.* (3), CD005454.
- Santos Tde, J., de Castro-Costa, C.M., Giffoni, S.D., Santos, F.J., Ramos, R.S., and Gifoni, M.A. (1999). The effect of baclofen on spontaneous and evoked behavioural expression of experimental neuropathic chronic pain. *Arq. Neuropsiquiatr.* **57**(3B), 753–760.
- Sarlis, N.J., Chowdrey, H.S., Stephanou, A., and Lightman, S.L. (1992). Chronic activation of the hypothalamo-pituitary-adrenal axis and loss of circadian rhythm during adjuvant-induced arthritis in the rat. *Endocrinology* **130**(4), 1775–1779.
- Sawynok, J., Reid, A.R., and Esser, M.J. (1999). Peripheral antinociceptive action of amitriptyline in the rat formalin test: Involvement of adenosine. *Pain* **80**(1–2), 45–55.
- Sawynok, J., Reid, A.R., Liu, X.J., and Parkinson, F.E. (2005). Amitriptyline enhances extracellular tissue levels of adenosine in the rat hindpaw and inhibits adenosine uptake. *Eur. J. Pharmacol.* **518**(2–3), 116–122.
- Schnitzer, T.J. (2006). Update on guidelines for the treatment of chronic musculoskeletal pain. *Clin. Rheumatol.* **25**(Suppl. 7), 22–29.
- Schwei, M.J., Honore, P., Rogers, S.D., Salak-Johnson, J.L., Finke, M.P., Ramnaraine, M.L., Clohisey, D.R., and Mantyh, P.W. (1999). Neurochemical and cellular reorganization of the spinal cord in a murine model of bone cancer pain. *J. Neurosci.* **19**(24), 10886–10897.
- Sharif Naeni, R., Cahill, C.M., Ribeiro-da-Silva, A., Menard, H.A., and Henry, J.L. (2005). Remodelling of spinal nociceptive mechanisms in an animal model of monoarthritis. *Eur. J. Neurosci.* **22**(8), 2005–2015.
- Shimoyama, M., Tatsuoka, H., Ohtori, S., Tanaka, K., and Shimoyama, N. (2005). Change of dorsal horn neurochemistry in a mouse model of neuropathic cancer pain. *Pain* **114**(1–2), 221–230.
- Smith, L.J., Krugner-Higby, L., Clark, M., Wendland, A., and Heath, T.D. (2003). A single dose of liposome-encapsulated oxymorphone or morphine provides long-term analgesia in an animal model of neuropathic pain. *Comp. Med.* **53**(3), 280–287.
- Stewart, L.S., and Martin, W.J. (2003). Influence of postoperative analgesics on the development of neuropathic pain in rats. *Comp. Med.* **53**(1), 29–36.
- Suyama, H., Kawamoto, M., Gaus, S., and Yuge, O. (2004). Effect of etodolac, a COX-2 inhibitor, on neuropathic pain in a rat model. *Brain Res.* **1010**(1–2), 144–150.
- Takasaki, I., Kurihara, T., Saegusa, H., Zong, S., and Tanabe, T. (2005). Effects of glucocorticoid receptor antagonists on allodynia and hyperalgesia in mouse model of neuropathic pain. *Eur. J. Pharmacol.* **524**(1–3), 80–83.
- Takeda, K., Sawamura, S., Sekiyama, H., Tamai, H., and Hanaoka, K. (2004). Effect of methylprednisolone on neuropathic pain and spinal glial activation in rats. *Anesthesiology* **100**(5), 1249–1257.
- Tall, J.M., Stuesse, S.L., Cruce, W.L., and Crisp, T. (2001). Gender and the behavioral manifestations of neuropathic pain. *Pharmacol. Biochem. Behav.* **68**(1), 99–104.
- Tanga, F.Y., Raghavendra, V., and DeLeo, J.A. (2004). Quantitative real-time RT-PCR assessment of spinal microglial and astrocytic activation markers in a rat model of neuropathic pain. *Neurochem. Int. Glial Biol. Funct. Interact. Glia Neurons* **45**(2–3), 397–407.
- Ulrich-Lai, Y.M., Xie, W., Meij, J.T., Dolgas, C.M., Yu, L., and Herman, J.P. (2006). Limbic and HPA axis function in an animal model of chronic neuropathic pain. *Physiol. Behav.* **88**(1–2), 67–76.
- Urch, C.E., Donovan-Rodriguez, T., and Dickenson, A.H. (2003). Alterations in dorsal horn neurons in a rat model of cancer-induced bone pain. *Pain* **106**(3), 347–356.

- Visser, E., and Schug, S.A. (2006). The role of ketamine in pain management. *Biomed. Pharmacother.* **60**(7), 341–348.
- Walczak, J.S., and Beaulieu, P. (2006). Comparison of three models of neuropathic pain in mice using a new method to assess cold allodynia: The double plate technique. *Neurosci. Lett.* **399**(3), 240–244.
- Walczak, J.S., Pichette, V., Leblond, F., Desbiens, K., and Beaulieu, P. (2005). Behavioral, pharmacological and molecular characterization of the saphenous nerve partial ligation: A new model of neuropathic pain. *Neuroscience* **132**(4), 1093–1102.
- Walczak, J.S., Pichette, V., Leblond, F., Desbiens, K., and Beaulieu, P. (2006). Characterization of chronic constriction of the saphenous nerve, a model of neuropathic pain in mice showing rapid molecular and electrophysiological changes. *J. Neurosci. Res.*, **83**(7), 1310–1322.
- Wallace, M.S. (2005). Diagnosis and treatment of neuropathic pain. *Curr. Opin. Anaesthesiol.* **18**(5), 548–554.
- Wang, D., Wang, M., Cheng, Y., and Fitzgerald, G.A. (2005). Cardiovascular hazard and non-steroidal anti-inflammatory drugs. *Curr. Opin. Pharmacol.* **5**(2), 204–210.
- Wang, H., Sun, H., Della Penna, K., Benz, R.J., Xu, J., Gerhold, D.L., Holder, D.J., and Koblan, K.S. (2002). Chronic neuropathic pain is accompanied by global changes in gene expression and shares pathobiology with neurodegenerative diseases. *Neuroscience* **114**(3), 529–546.
- Wang, S., Lim, G., Zeng, Q., Sung, B., Ai, Y., Guo, G., Yang, L., and Mao, J. (2004). Expression of central glucocorticoid receptors after peripheral nerve injury contributes to neuropathic pain behaviors in rats. *J. Neurosci.* **24**(39), 8595–8605.
- Weiland, L., Croubels, S., Baert, K., Polis, I., De Backer, P., and Gasthuys, F. (2006). Pharmacokinetics of a lidocaine patch 5% in dogs. *J. Vet. Med. A Physiol. Pathol. Clin. Med.* **53**(1), 34–39.
- Weir, M.R., Sperling, R.S., Reicin, A., and Gertz, B.J. (2003). Selective COX-2 inhibition and cardiovascular effects: A review of the rofecoxib development program. *Am. Heart J.* **146**(4), 591–604.
- Wiese, A.J., Muir, W.W., III, and Wittum, T.E. (2005). Characteristics of pain and response to analgesic treatment in dogs and cats examined at a veterinary teaching hospital emergency service. *J. Am. Vet. Med. Assoc.* **226**(12), 2004–2009.
- Wieseler-Frank, J., Maier, S.F., and Watkins, L.R. (2004). Glial activation and pathological pain. *Neurochem. Int.* **45**(2–3), 389–395.
- Wieseler-Frank, J., Maier, S.F., and Watkins, L.R. (2005). Immune-to-brain communication dynamically modulates pain: Physiological and pathological consequences. *Brain Behav. Immun.* **19**(2), 104–111.
- Wilson, K.G., Mikail, S.F., D'Eon, J.L., and Minns, J.E. (2001). Alternative diagnostic criteria for major depressive disorder in patients with chronic pain. *Pain* **91**(3), 227–234.
- Windle, R.J., Wood, S.A., Kershaw, Y.M., Lightman, S.L., Ingram, C.D., and Harbuz, M.S. (2001). Increased corticosterone pulse frequency during adjuvant-induced arthritis and its relationship to alterations in stress responsiveness. *J. Neuroendocrinol.* **13**(10), 905–911.
- Wiseman-Orr, M.L., Nolan, A.M., Reid, J., and Scott, E.M. (2004). Development of a questionnaire to measure the effects of chronic pain on health-related quality of life in dogs. *Am. J. Vet. Res.* **65**(8), 1077–1084.
- Womer, D.E., and Shannon, H.E. (2000). Pharmacologic reversal of pertussis toxin-induced thermal allodynia in mice. *Neuropharmacology* **39**(10), 1732–1739.
- Woolf, C.J. (2004). Pain: Moving from symptom control toward mechanism-specific pharmacologic management. *Ann. Intern. Med.* **140**(6), 441–4451.
- Woolf, C.J., and Max, M.B. (2001). Mechanism-based pain diagnosis: Issues for analgesic drug development. *Anesthesiology* **95**(1), 241–249.
- Xie, W., Liu, X., Xuan, H., Luo, S., Zhao, X., Zhou, Z., and Xu, J. (2006). Effect of betamethasone on neuropathic pain and cerebral expression of NF-kappaB and cytokines. *Neurosci. Lett.* **393**(2–3), 255–259.
- Xu, X.J., Hao, J.X., Andell-Jonsson, S., Poli, V., Bartfai, T., and Wiesenfeld-Hallin, Z. (1997). Nociceptive responses in (interleukin) IL-6-deficient mice to peripheral inflammation and peripheral nerve section. *Cytokine* **9**(12), 1028–1033.
- Yaari, Y., Selzer, M.E., and Pincus, J.H. (1986). Phenytoin: Mechanisms of its anticonvulsant action. *Ann. Neurol.* **20**(2), 171–184.
- Yasuda, T., Miki, S., Yoshinaga, N., and Senba, E. (2005). Effects of amitriptyline and gabapentin on bilateral hyperalgesia observed in an animal model of unilateral axotomy. *Pain* **115**(1–2), 161–170.
- Yen, L.D., Bennett, G.J., and Ribeiro-da-Silva, A. (2006). Sympathetic sprouting and changes in nociceptive sensory innervation in the glabrous skin of the rat hind paw following partial peripheral nerve injury. *J. Comp. Neurol.* **495**(6), 679–690.
- Zhang, J., and De Koninck, Y. (2006). Spatial and temporal relationship between monocyte chemoattractant protein-1 expression and spinal glial activation following peripheral nerve injury. *J. Neurochem.* **97**(3), 772–783.
- Zurek, J.R., Nadeson, R., and Goodchild, C.S. (2001). Spinal and supraspinal components of opioid antinociception in streptozotocin induced diabetic neuropathy in rats. *Pain* **90**(1–2), 57–63.

Anaesthesia and Analgesia in the Foetus and Neonate

J.C. Murrell, D.J. Mellor, and C.B. Johnson

I. Introduction	594
II. Is the Foetus Conscious?	594
A. Development of Neuroanatomical Pathways	595
B. Is the Neurologically Mature Foetus Maintained in a 'Sleep-Like' State?	595
C. Are Neurologically Immature Foetuses Ever Conscious?	596
D. Key Point 1: Prerequisites for Pain Experience	596
III. Does Foetal Unconsciousness Persist During Noxious Interventions?	596
A. Key Point 2: Foetus is Almost Certainly Unconscious Throughout Gestation	597
IV. Does Noxious Stimulation Activate the Foetal Stress Response?	597
A. Key Point 3: Stress Responses and Analgesics	597
V. Might Noxious Stimulation of the Foetus Cause Long-Term Changes in Pain Processing?	597
A. Key Point 4: Foetal Pharmacokinetics and Pharmacodynamics	598
B. Key Point 5: Foetus is not an Unborn Neonate	598
VI. Anaesthesia of the Dam for Foetal Surgery	598
A. Inhalational Agents	599
B. Propofol	599
C. Thiopental	599
D. Ketamine	599
E. Alpha ₂ Adrenoreceptor Agonists	599
F. Opioids	600
G. Key Point 6: Foetal Responses to Opioids Can Vary Between Drugs and Species	600
H. Non-Steroidal Anti-Inflammatory Drugs (NSAIDs)	600
VII. Epidural Analgesia/Anaesthesia	600
VIII. Prevention of Post-Operative Pre-Term Labour	601
A. Key Point 7: Prevention of Pre-Term Parturition	601
IX. Functional Maturity of Key Organ Systems in Newborn Animals	601
A. Cardiovascular Physiology	601
B. Respiratory System	601
C. Urinary System	602
D. Hepatobiliary System	602

X.	Anaesthesia of Neonatal Animals	602
A.	Key Point 8: Balanced Anaesthesia	602
B.	Drug Selection	602
C.	Key Point 9: Monitoring During Anaesthesia	603
XI.	Supportive Measures During Neonatal Anaesthesia	603
A.	Body Temperature	603
B.	Blood Glucose	604
XII.	Post-Operative Period	604
XIII.	Neonatal Analgesia	604
A.	Key-point 10: Multi-Modal Analgesia	605
B.	Key Point 11: Pain Assessment	605
C.	Opioids	605
D.	Non-Steroidal Anti-Inflammatory Drugs	605
XIV.	Concluding Comments	605
	References	606

I. INTRODUCTION

Increasing attention is currently being given to foetal and neonatal anaesthesia and analgesia by members of the medical and veterinary professions and animal research community. In contrast to human medicine, in veterinary clinical practice interventions are rarely carried out on the foetuses of any species prior to labour. However, surgical or other invasive procedures in animals have been an integral part of foetal and neonatal research for many decades. For instance, animal models have been and are commonly used to advance the clinical management of human infants before, during and after birth (Mellor and Gregory, 2003) and to refine surgical techniques for in utero procedures in human foetuses, such as intrauterine treatments for spina bifida (Eggink et al., 2005; Michejda, 1984). Favoured models for this work have usually employed foetal sheep, in part because they are neurologically mature at birth as is the human foetus. Clearly, the findings of such work and its experimental approach have direct relevance in the veterinary context. Thus, foetal and neonatal instrumentation techniques employing surgery have also been directed at, for example, the causes and prevention of perinatal mortality and morbidity in farm livestock (Mellor, 1988; Mellor and Gregory, 2003; Mellor and Stafford, 2004), the clinical management of dystocia (Mellor and Gregory, 2003) and humane slaughter techniques for pregnant ruminants (Mellor and Gregory, 2003; van der Valk et al., 2004). Such research has employed anaesthesia of the pregnant dam and/or newborn but, until relatively recently, the use of intra- or post-operative analgesia has rarely been considered.

The need for foetal anaesthesia or analgesia is an area of current debate in human medicine. It is uncertain at what age a human foetus may be capable of experiencing or perceiving pain, or indeed whether a foetus can ever *experience* pain in utero (Lee et al., 2005; Mellor et al., 2005). The answer to this question will have a huge impact on attitudes towards the need for anaesthesia or analgesia in foetuses undergoing surgery or invasive procedures. Further, the longer-term consequences arising from invasive procedures on the foetus, regardless of

whether the stimuli so generated are perceived as painful or not, are unknown. Such stimuli can cause activation of the stress response, and may potentially have a long-term influence on the processing of noxious stimuli (Mellor et al., 2005). These sequelae may justify the use of anaesthesia and/or analgesia, even if the foetus is unconscious and unable to experience pain at the time of the intervention.

In the veterinary context, however, an additional factor needs to be considered. It is the neurological maturity of the foetus at birth, because the implications for foetal and neonatal anaesthesia and analgesia differ depending on whether the young are mature (precocial), as in cattle, deer, goats, sheep, horses, pigs and guinea pigs (Ellingson and Rose, 1970; Mellor and Diesch, 2006; Mellor and Gregory, 2003; Mellor and Stafford, 2004), or relatively immature (altricial), as in cats, dogs, mice, rats and rabbits (Ellingson and Rose, 1970). Although most consideration to date has been given to the former category, we shall also provide comment on the latter.

In this chapter ‘foetus’ refers to the antenatal individual during at least the last two-thirds of pregnancy including birth, and ‘neonate’ or ‘newborn’ to mammalian young within the first few days after birth.

In order to provide a balanced discussion on the need for anaesthesia and analgesia in foetal animals, we will first provide an overview of the literature pertaining to foetal consciousness in species that are neurologically mature at birth and we will then consider those that are less mature at birth.

II. IS THE FOETUS CONSCIOUS?

As pain is a sensory and emotional experience that requires the presence of consciousness to permit recognition of a stimulus as unpleasant (IASP, 2004), by definition, in order to experience pain the foetus must be conscious. Neurological maturity at birth has direct relevance to this because of two preconditions for animals to be able to *experience* any sensations, including pain (Mellor and Diesch, 2006). The

nervous system must first develop the capacity for sentience, that is, the neurological apparatus must allow perception by the senses; and second, the brain must also be in a state of consciousness. The evidence suggests that in precocial young the foetal brain is too immature initially to support sentience or any state resembling consciousness, and subsequently, that when the capacity for sentience does appear, sleep-like states of unconsciousness are maintained continuously by neuroinhibitory factors that operate in the in utero environment (Mellor and Diesch, 2006, 2007; Mellor et al., 2005). In altricial young, however, neurological immaturity apparently persists throughout pregnancy and the capacity for sentience does not seem to develop until after birth (Ellingson and Rose, 1970). These observations are consistent with the view that mammalian foetuses cannot *experience* any sensations, including pain, at any stage before birth.

A. Development of Neuroanatomical Pathways

The processing of nociceptive stimuli requires peripheral sensory receptors, afferent and efferent sensory and motor pathways and subcortical and cortical neural integration of the related impulse traffic (Almeida et al., 2004). The thalamus plays a crucial role in integrating the transmission of noxious information between the periphery and the cortex and it is recognised that thalamocortical connections must be intact to allow noxious stimuli to be perceived as pain by the foetus (Smith et al., 2000). The exact stage at which these thalamocortical connections become functional in human foetuses is unknown. Between 22 and 26 weeks of gestation the subplate zone of the cortex contains an abundant mixture of cholinergic, thalamocortical and corticocortical waiting neurones (Glover and Fisk, 1999; Kostovic and Goldman-Rakic, 1984). There are also transient foetal synaptic circuits between the subplate and cortical plate neurones during this period (Glover and Fisk, 1999), suggesting that maturation occurs gradually within this 22–26-week time window. Once these connections are complete the neuroanatomical pathways required for cortical processing of noxious information are intact. These observations are reinforced by the knowledge that otherwise healthy babies born prematurely during the last 10 weeks of the usual 40-week human pregnancy are clearly capable of consciousness and respond to auditory, visual, taste, thermal, touch, painful and other stimuli (Lee et al., 2005; Mellor et al., 2005). A similar pattern of development is considered to occur in foetal sheep (Mellor and Diesch, 2006; Mellor et al., 2005), which at birth are neurologically somewhat more mature than human infants. Differentiation of electroencephalographic activity into rapid-eye-movement (REM) and non-REM patterns occurs (Mellor et al., 2005) after about 80% of pregnancy has elapsed in such foetuses (Ellingson and Rose, 1970; Mellor et al., 2005). However, in the altricial newborns of dogs, cats, mice, rats and rabbits REM–non-REM differentiation does not apparently

occur until between 3 and 14 days after birth depending on the species (Ellingson and Rose, 1970).

B. Is the Neurologically Mature Foetus Maintained in a ‘Sleep-Like’ State?

Clinical and experimental literature suggests the foetus is maintained in ‘sleep-like’ states, and is therefore unconscious (Mellor et al., 2005). This is supported by electroencephalographic studies demonstrating that from mid-gestation the foetal electroencephalogram (EEG) begins to evolve from a discontinuous pattern into coherent discrete states that are suggestive of sleep and referred to as sleep states (Okai et al., 1992; Precht and Nijhuis, 1983). In late gestation two distinct sleep patterns are recognised. They are REM or active sleep, characterised by high-frequency, low-amplitude EEG activity, and non-REM or quiet sleep, characterised by low-frequency, high-amplitude EEG activity (Mellor et al., 2005; Rigatto, 2004). These two patterns form the dominant foetal state for at least 95% of the time. It is noteworthy that the remaining 5% represent the sum total of numerous epochs of a few seconds duration each during frequent transitions between REM and non-REM sleep-like states (Mellor et al., 2005). Although until now there has been no consensus on whether movement behaviours and EEG patterns recorded during these short epochs represent unconscious or conscious wakefulness or continuing unconsciousness (Crossley et al., 1997; de Vries et al., 1988; Jansen and Chernick, 1991), a recent re-evaluation (Mellor et al., 2005) led to the conclusion that these periods of so-called wakefulness actually represent sleep transitions similar to those described as ‘indeterminate sleep’ in the newborn (Ferri et al., 2003). Thus, the increasing occurrence of this state with increasing foetal age reflects an increased rate of switching between sleep states with advancing gestational age, rather than indicating that the foetus is increasingly likely to become conscious (Mellor et al., 2005; Szeto and Hinman, 1985; van den Pas et al., 1994). Indeed, during labour foetal unconsciousness becomes deeper because of an increase in the proportion of time spent in the non-REM sleep-like state (Shinozuka and Nathanielsz, 1998).

The uterus evidently plays a key role in providing chemical and physical factors that together help to keep the foetus in continuous sleep-like states during late pregnancy (Mellor et al., 2005). All factors identified have demonstrable inhibitory effects on the foetal EEG. Thus it has been proposed that a range of in utero neuroinhibitory factors secreted by the placenta and foetus, as well as warmth, buoyancy and cushioned tactile stimulation within the uterine environment, together act to maintain foetal states of unconsciousness before and throughout the period after the capacity for sentience has developed in precocial young (Mellor and Gregory, 2003; Mellor et al., 2005).

Adenosine, a potent neural inhibitor which promotes sleep and/or unconsciousness (Dunwiddie and Masino, 2001), is produced by placental and foetal tissues in quantities that maintain

its circulating concentrations two- to fourfold higher in the foetus than in the mother, and is a proven suppressor of foetal EEG activity (Mellor et al., 2005). Allopregnanolone and pregnanolone are neuroactive steroids with anaesthetic, hypnotic and analgesic effects (Majewska, 1992; Miller and Martin, 1998). They are produced from cholesterol or progesterone by the placenta and the foetal brain, exhibit high circulating concentrations in the foetus and have suppressive effects on foetal EEG, eye movements, breathing movements and postural changes (Crossley et al., 1997; Hirst et al., 2000). Prostaglandin D₂ is a potent sleep-inducing agent in adult animals. It is an active suppressor of eye, breathing and postural muscle movements and associated EEG activity in the late gestation foetus (Lee et al., 2002). Likewise, a possible placental peptide inhibitor, warmth, cushioned tactile stimulation and buoyancy are also considered to contribute to the maintenance of sleep-like EEG activity in the foetus until birth (Mellor and Gregory, 2003; Mellor et al., 2005).

C. Are Neurologically Immature Foetuses Ever Conscious?

The electrical activity in the cerebral cortex is of particular note here because, as already stated, it is an index of the degree of functional maturation of the cortex that is required for consciousness to occur (Ellingson and Rose, 1970; Mellor and Diesch, 2007; Mellor et al., 2005). Pre-cortical and cortical structures are electrically silent early in foetal life—there is no recordable EEG activity. The EEG then exhibits sporadic spikes, which evolve into short periods of sustained activity against a background of electrical silence. Continuous mixed sleep-like EEG activity then appears and this subsequently matures into differentiated and alternating REM and non-REM sleep-like patterns. As just noted, this whole progression occurs before birth in species that produce precocial newborns, including those of cattle, deer, goats, sheep, horses, pigs and guinea pigs. However, in the altricial newborns of species such as the cat, dog, mouse, rat and rabbit only the early developmental stages occur prenatally. Thus, their EEGs variously exhibit the following characteristics at birth (Ellingson and Rose, 1970): electrical silence or very low-voltage activity, intermittent activity, or continuous and undifferentiated activity. Only after 3–14 days does REM–non-REM differentiation occur, and EEG evidence of conscious wakefulness is not apparent before this. The conclusion that may be drawn from these observations is that the young of these species are unconscious before birth and therefore they cannot experience pain or any other sensations until the capacity for consciousness develops after birth.

D. Key Point 1: Prerequisites for Pain Experience

In order to experience pain the foetus must be conscious. The development of the neurological apparatus required for the

conscious perception of pain is incomplete in species that give birth to neurologically immature (altricial) young, whereas in young that are neurologically mature at birth (precocial) sufficient development occurs by about 80% of pregnancy. Therefore anaesthesia and analgesia solely to prevent foetal pain perception during foetal interventions is not apparently required in altricial young, nor during at least the first half of pregnancy in precocial young. Although the latter group develops the capacity for sentience prenatally, a large body of evidence suggests that in normal circumstances such foetuses are maintained in sleep-like, unconscious states until after birth (Mellor and Diesch, 2006; Mellor and Gregory, 2003; Mellor et al., 2005). This would also remove the need to provide anaesthesia and analgesia to prevent pain perception during the second half of gestation, provided that such foetuses are not aroused to consciousness by noxious stimulation.

III. DOES FOETAL UNCONSCIOUSNESS PERSIST DURING NOXIOUS INTERVENTIONS?

This question is clearly not relevant to any foetuses of altricial species because their brains are apparently too neurologically immature to support states of consciousness until after birth. Nor is it relevant during at least the first half of pregnancy in species that give birth to precocial young. In the latter group, however, it is worthwhile to consider whether or not, during the last half of pregnancy and in spite of the neuroinhibitors that usually keep precocial foetuses in unconscious states, such mature foetuses can be aroused to consciousness by noxious stimuli that are known to potently arouse newborns from sleep.

Some observations in foetal sheep suggest that the foetus is not arousable. Vibroacoustic stimulation of sufficient intensity to induce auditory pain in conscious humans and movements in foetal sheep does not cause the foetal EEG to change from sleep-like to aroused or conscious patterns (Leader et al., 1988; Schwab et al., 2000). In addition, hypoxaemia and hypercapnoea, which potently arouse newborns, lead instead to deeper states of unconsciousness in mature foetuses (Hunter et al., 2003; Mallard et al., 1992; Mellor et al., 2005; Watson et al., 2002) because of an adenosine-induced shutdown of EEG activity during foetal hypoxaemia (Kubonoya and Power, 1997).

There remains the question of the impact, if any, of surgical stimulation on foetal unconsciousness. Foetal movements begin early in pregnancy, occurring spontaneously and also in response to noxious stimulation (Mellor and Gregory, 2003). However until the cortex has developed to the stage of being a functional unit, these movements are reflexes (i.e. an involuntary response to a stimulus) rather than a conscious response to pain perception. Even after the maturation of neuroanatomical pathways required for consciousness, the existence of reflex actions simply demonstrates that nerve connections to the spinal cord and return motor circuits are functional. Reflex and pain circuits

are separate, such that reflexes can occur without pain perception, and pain perception can occur without concurrent reflex activation. Thus, the movements elicited in unanaesthetised foetuses by invasive procedures and their absence when the dam is given general anaesthesia and sufficient time is allowed for it to act (Mellor and Gregory, 2003) do not unequivocally indicate that the foetus has been aroused to consciousness. Indeed, EEG patterns at post-operative stages after foetal instrumentation when general anaesthesia would have waned suggest that any noxious sensory input during that period is not arousing in the foetus (Mellor et al., 2005). However, a definitive experiment evaluating EEG responses to surgery conducted on foetuses well after recovery from the original anaesthesia and instrumentation has not apparently been done.

A. Key Point 2: Foetus is Almost Certainly Unconscious Throughout Gestation

In summary, in addition to the strong evidence indicating that 'non-stimulated' mature foetuses remain in continuous states of sleep-like unconsciousness throughout the last half of pregnancy, and that these states are actively maintained by a range of in utero neuroinhibitors, there are also clear indications that noxious auditory stimulation and hypoxaemia/hypercapnoea, which would awaken newborns from sleep, do not elicit arousal in mature foetuses. Moreover, although the definitive experiment remains to be done and despite physical movements in response to invasive procedures in unanaesthetised foetuses, there is some evidence that surgical stimulation does not arouse foetuses to consciousness either.

IV. DOES NOXIOUS STIMULATION ACTIVATE THE FOETAL STRESS RESPONSE?

Noxious stimulation causes physiological changes in the foetus, particularly activation of the hypothalamic–pituitary–adrenal (HPA) and hypothalamic–adrenomedullary stress responses (Giannakouloupoulos et al., 1999; Smith et al., 2000), which are characterised by increases in circulating plasma concentrations of cortisol, β endorphin and noradrenaline (Giannakouloupoulos et al., 1994, 1999; Houfflin-Debarge et al., 2005). Moreover, nociceptive stimuli have also been shown to increase plasma cortisol concentration and increase pulmonary vascular resistance in foetal sheep (Houfflin-Debarge et al., 2005). However, hormonal and cardiovascular responses to noxious stimulation do not constitute definitive evidence of the conscious perception of pain as such stress responses do not require cortical activation (Lee et al., 2005; Mellor et al., 2005).

Although administration of fentanyl prior to intrauterine needling in human foetuses between 20 and 35 weeks of gestation (Fisk et al., 2001) and giving sufentanil to mature sheep

foetuses exposed to nociceptive stimuli (Houfflin-Debarge et al., 2005) blunt the foetal stress responses that occur if analgesia is not provided, the implicit assumption that such stress responses are bad needs to be questioned. It is important to recall that the functional purpose of stress responses is to maintain or restore homeostasis (Taylor et al., 1997b; Watt and Ledingham, 1984), not, as may be presumed clinically, to help us to assess presumed pain. Accordingly, in situations where pain *experience* is not apparently of concern, as in the foetus, minimising physiological stress responses may deprive the foetus of the associated benefits. Moreover, we are profoundly ignorant of the actions, dosage, clearance and side effects within the foetus of numerous analgesics that are efficacious in the newborn, and some deleterious effects of some analgesics on the foetus have been demonstrated (Bennet et al., 1986; Doyle et al., 2005; Taylor et al., 1997a). On this basis, therefore, we strongly recommend caution when contemplating applying analgesia to the foetus, at the very least until we understand better what we are doing. Evidence from animal studies that activation of foetal stress responses may have some long-term negative effects on hippocampal development and stress behaviour (Clarke et al., 1994; Meaney and Aitken, 1985; Schneider et al., 1992; Uno et al., 1990) should stimulate us to actively seek that improved understanding.

A. Key Point 3: Stress Responses and Analgesics

Although it is recognised in adult animals that activation of appropriate stress responses to factors such as noxious stimulation and trauma is important for survival (Watt and Ledingham, 1984), and that short-term stress responses to noxious stimulation of the foetus may be beneficial (Taylor et al., 1997b), the implications of long-term foetal stress responses, which may be deleterious, are not fully understood. Nor are the actions of most analgesics that are known to be efficacious in newborn and young animals. This is an area that clearly merits further investigation.

V. MIGHT NOXIOUS STIMULATION OF THE FOETUS CAUSE LONG-TERM CHANGES IN PAIN PROCESSING?

In adult animals it is accepted that pain pathways are not hard wired and are able to change in response to nociceptive input. Repeated noxious stimulation causes an increased sensitivity to pain due to changes in both the peripheral and central nervous system (Woolf and Salter, 2000), such that pain can be more difficult to manage in a clinical arena once these changes have occurred (Ma and Woolf, 1995). Whether similar changes in the pain pathway occur in response to noxious stimuli in utero is not known. In human infants, behavioural or

physiological responses attributed to the pain associated with vaccination several months after birth are reportedly greater in infants that required instrumentally assisted birth compared to those who did not (Taylor et al., 2000), and in infants who were circumcised as newborns compared to those who were not (Taddio et al., 1997). It is important to appreciate, however, that there are apparently no studies that have robustly tested such phenomena in the foetus. Thus, there are no empirical foetal data to demonstrate a causal relationship between noxious sensory inputs and the presumed potential for subsequent greater sensitivity to pain (Mellor et al., 2005), whether that might occur before or after birth. Indeed, robust postnatal clinical studies of young human infants are increasingly suggesting that this is not an important effect at least in the newborn (Moiniche et al., 2002).

A. Key Point 4: Foetal Pharmacokinetics and Pharmacodynamics

The relevance of these findings to the foetus is uncertain. It is possible that application of noxious stimuli without analgesia causes similar changes in developing foetal pain pathways, which may result in altered pain perception in the newborn or even adult animal. This possibility might support the use of analgesia in the foetus. However caution must always be exercised before the administration of analgesic drugs directly to the foetus. Responses to analgesic agents in prematurely born neonates cannot be directly extrapolated to foetuses of similar gestational age (see Key Point 5). Data pertaining to the pharmacokinetics and dynamics of analgesic and anaesthetic drugs in foetuses are lacking, and until these data are available the potential for negative consequences of foetal drug administration must always be considered.

B. Key Point 5: Foetus is not an Unborn Neonate

The foetus is not simply a newborn that happens to still occupy the uterus. The foetal brain and other vital organs operate in an entirely different physiological environment from that of the newborn (Mellor et al., 2005), and the foetus and newborn have demonstrably different responses to putatively arousing, painful and/or distressing stimuli (see above), and to at least one analgesic (morphine) (Mellor et al., 2005). Regarding foetal analgesia, we are largely ignorant of the pharmacokinetics, pharmacodynamics, efficacy and short- or long-term deleterious effects of analgesic drugs in the foetus. There is some evidence to suggest that managing the foetal stress responses and minimising the activation of foetal pain pathways with analgesic and anaesthetic drugs may be beneficial. In veterinary practice this can be provided by anaesthetising the dam and allowing sufficient time for the agents to cross the placenta to the foetus before the start of surgery.

VI. ANAESTHESIA OF THE DAM FOR FOETAL SURGERY

Pregnancy causes many physiological changes in the dam that will influence the pharmacokinetics and pharmacodynamics of administered anaesthetic and analgesic drugs. Changes in maternal physiology during pregnancy that may affect drug pharmacology include:

- Reduction in gastrointestinal motility
- Increase in cutaneous blood flow
- Increase in volume of distribution (due to the water associated with the placenta, foetus and increase in circulating blood volume)
- Increase in total body fat which may influence the distribution of lipophilic drugs
- Changes in hepatic enzyme function
- Increase in renal excretion which may increase the clearance of some drugs

For more details see Martin (1996).

The clinical impact of these changes on anaesthetic drug selection and dose in different animal species has not been investigated. Most of the recommendations regarding drug administration to pregnant animals are derived from the human literature. Given the paucity of data describing the pharmacokinetics and pharmacodynamics of anaesthetic drugs in pregnant animals, anaesthetic drugs should be given 'to effect' to avoid inadvertent drug over or under dosing. This may be difficult to do with rodents, as many of the most popular anaesthetics are given by routes other than inhalation or intravenous (IV) injection. Under these circumstances, extra care should be taken to utilise appropriate doses.

There are several sources of variability in determining the effect of maternally given drugs on the foetal central nervous system. The placental barrier is a lipoprotein, so that drugs with lipid solubility will cross the placenta to exert an anaesthetic action on the foetus. The thickness of the placenta decreases throughout gestation, which facilitates diffusion of drugs across the placenta in older foetuses. However the stage of gestation may also affect foetal drug metabolism. The liver is able to metabolise drugs in the maturing human foetus, which influences foetal drug metabolism (Wunsch et al., 2003). The foetal liver in dogs has little capability to metabolise drugs, whereas the situation in other animal species is unknown.

Goals of maternal anaesthesia/analgesia:

- Prevent or minimise pain resulting from surgery to the dam and foetus
- Maintain the dam in a quiet and non-stressed state
- Prevent or reduce the likelihood of foetal abortion after the end of the procedure

Goals of maternal anaesthesia/analgesia for the foetus

- Manage foetal stress responses (but see Key Point 3)

- Prevent or minimise changes in the pain pathway that may lead to changes in pain perception in postnatal life (but see Key Point 4)
- Obtund the potential for awareness and possible pain perception (but see Key Point 1)
- Prevent foetal movements that may make the surgical procedure difficult to carry out

The choice of anaesthetic protocol for the individual patient will be determined by the species, the invasiveness of the procedure to be carried out on the foetus and the stage of gestation. The foetal lamb is widely used for biomedical and veterinary studies of foetal and neonatal physiology, such that most experimental data describing the effects of anaesthetics on foetal circulation have been obtained from experiments carried out in a sheep model. Therefore general recommendations pertaining to maternal anaesthesia for foetal surgery are usually derived from studies in sheep and extrapolated across species. A full description of different suggested anaesthesia protocols across species is beyond the scope of this chapter. In general the same principles of anaesthesia apply to pregnant animals as to any individual, particularly with regard to monitoring and maintenance of cardiovascular and respiratory function with supportive measures such as fluid therapy. We will highlight experimental data that support selection of particular anaesthetic agents or techniques for foetal surgery—for the most part these recommendations are derived from ovine studies.

A. Inhalational Agents

Inhalational agents cause uterine relaxation that can facilitate conditions for foetal surgery (Yoo et al., 2006). Work in sheep suggests that the foetus requires a lower concentration of inhalant agent to achieve the same level of anaesthesia as the adult (Gregory et al., 1983), so that anaesthetic concentrations sufficient to anaesthetise the dam will also anaesthetise the foetus. A number of studies have investigated the effects of maternally administered inhalant agents on the foetal circulation. These studies were not designed to investigate the comparative effects of the commonly used inhalant agents, halothane, sevoflurane and isoflurane, so that comparison between agents is difficult. Sabik et al. (1993) found that halothane significantly decreased foetal cardiac output and placental blood flow, while significantly increased total vascular resistance, such that placental gas exchange was impaired. It has been suggested that the immature lamb heart is very sensitive to the calcium channel blocking properties of halothane, which may result in adverse effects of halothane on cardiac function in the foetus (Davis et al., 1995). Halothane also has a lesser effect on uterine relaxation compared to other volatile agents (Yoo et al., 2006). Evidence suggests that isoflurane compared to halothane has a less marked effect on the foetal cardiovascular system (Bachman et al., 1986; Palmisano et al., 1994). In a goat model, sevoflurane was associated with significant hypotension in the foetus

(Setoyama et al., 2003), although sevoflurane is widely used to provide anaesthesia for caesarean section in women without reported adverse foetal effects (Olthoff and Rohrbach, 1998). In summary, these data suggest that although halothane has been used for many years for maternal anaesthesia for foetal surgery, the newer volatile agents provide better maternal and foetal cardiovascular stability. There are insufficient data to support the recommendation of isoflurane over sevoflurane or vice versa.

B. Propofol

Propofol is routinely used for induction of anaesthesia for caesarean section in women (Moore et al., 1989) and is recognised to be a safe and efficacious agent. Propofol has also been widely investigated for induction or maintenance of anaesthesia in pregnant sheep, and effects of the drug on the foetal circulation have been studied. Alon et al. (1993) compared foetal circulatory parameters during maternal anaesthesia with either IV propofol or isoflurane and found that propofol compared to isoflurane was not associated with circulatory compromise. Studies in other species have found similar results (Abboud et al., 1995; Andaluz et al., 2005; Setoyama et al., 2003), supporting the safety of propofol for maternal induction or maintenance of anaesthesia (by continuous rate infusion) during foetal surgery.

C. Thiopental

The pharmacokinetic characteristics of thiopental render it unsuitable for maintenance of anaesthesia; however, thiopental is widely used as an induction agent in pregnant animals. A number of studies have compared thiopental and propofol for caesarean section in women and found the two drugs to be equally safe in terms of neonatal outcome (Siafaka et al., 1992). However, thiopental for induction of anaesthesia for caesarean section in pregnant bitches was found to be associated with increased puppy mortality compared to propofol (Funkquist et al., 1997). Thiopental has also been evaluated as an induction agent in pregnant sheep and found to have minimal effects on the foetal circulation (Alon et al., 1993; McClaine et al., 2005).

D. Ketamine

Ketamine is widely used for the anaesthesia of pregnant sheep, and maternal ketamine administration is not associated with adverse effects on the foetus in this species (Strumper et al., 2004; Swartz et al., 1987). The effects of ketamine on the foetal rodent have not been reported.

E. Alpha₂ Adrenoreceptor Agonists

Drugs stimulating alpha₂ adrenoreceptors increase the contractility of the pregnant and non-pregnant uterus (Jedruch et al.,

1989b; Rexroad and Barb, 1978), resulting in an increase in intrauterine pressure. Xylazine has been associated with abortion when administered in the last third of pregnancy to cattle, presumably due to uterine contraction following drug administration (Hodgson et al., 2002). However, administration of medetomidine and detomidine to pregnant dogs and horses does not appear to increase the risk of abortion in these species (Jedruch et al., 1989a, 1989b).

Alpha₂ agonists are recognised to have profound effects on uterine blood flow, although whether this is a direct effect or results from increased uterine activity is unknown (Jansen et al., 1984; Sakamoto et al., 1996, 1997). However, the reduction in uterine blood flow associated with this class of drugs suggests that they should be avoided for maternal anaesthesia for foetal surgery in all species.

F. Opioids

Short-term administration of opioids to foetuses, either directly or via the maternal circulation, is not considered to be associated with adverse foetal effects in humans; however, this cannot be extrapolated across species. Morphine administration directly to foetal lambs caused hyperventilation which could potentially result in foetal hypoxia due to increased oxygen consumption associated with increased respiratory effort (Bennet et al., 1986). Longer-term opioid administration (few weeks) in humans may cause low birth weights and behavioural deficits in the newborn, and similar effects have been reported in laboratory animals (McLaughlin et al., 1978).

In animal models involving foetal surgery, opioid analgesia is more commonly provided to the dam. There are differences in placental transfer between opioids. A single dose of buprenorphine is associated with low placental transfer, resulting in limited availability to the foetal circulation (Nanovskaya et al., 2002), although with repeated doses the availability to the foetus increases (Fischer et al., 2000). Fentanyl and sufentanil are both rapidly transferred across the placenta to the foetal circulation, although rapid maternal reuptake of sufentanil limits foetal exposure compared to fentanyl (Loftus et al., 1995). Morphine can cross the placental barrier, and a continuous rate of infusion has been reported to increase maternal and foetal anaesthesia/analgesia after open foetal surgery in a primate model (Santolaya-Forgas et al., 2006).

G. Key Point 6: Foetal Responses to Opioids Can Vary Between Drugs and Species

While current evidence suggests that administration of judicious doses of some opioids to foetuses for short periods may have few long-term detrimental effects in man and primates and may reduce the foetal stress response to noxious stimuli (Fisk et al., 2001), there appear to be species differences in

foetal responses to individual opioid agents. A complete review of opioid effects in the foetus across different laboratory animal species is beyond the scope of this chapter, and for many species and opioid drugs data are lacking. Caution is advised before administration of opioid drugs to the foetus, and knowledge of the current literature pertaining to the individual species and drug is recommended. Administration of opioids to the dam will contribute to provision of a balanced anaesthetic technique and will reduce the dose requirement for volatile agents. Further studies investigating the optimal opioid drug and dose for foetal and maternal analgesia across species are required.

H. Non-Steroidal Anti-Inflammatory Drugs (NSAIDs)

NSAIDs inhibit cyclo-oxygenase production with a subsequent reduction in prostaglandin synthesis. NSAIDs are associated with a number of adverse effects in the human foetus, which result from inhibition of foetal prostaglandin synthesis. These effects include premature closure of the ductus arteriosus and foramen ovale, and pulmonary hypertension, nephrotoxicity, and abnormalities of foetal haemostasis. The potential for these adverse effects in animal species is unknown. Prevention of prostaglandin synthesis in newborn male rats by short exposure to an NSAID (indomethacin) impaired male sexual behaviour, while developmental (in utero) exposure to aspirin diminished sexual behaviour in the adult male rat (Amateau and McCarthy, 2004). The clinical relevance of these experimental findings is currently unknown. Prostaglandins also play an important role in maintenance of uterine and umbilical blood flow. The clinical significance of NSAIDs in maintenance of adequate placental blood flow, particularly during maternal systemic hypotension, is unknown. Administration of a single dose of an NSAID to a cardiovascularly stable dam after surgery is a common practice throughout pregnancy and is unlikely to be associated with adverse foetal effects, but prolonged NSAID administration during pregnancy is currently not recommended (Boubred et al., 2006).

VII. EPIDURAL ANALGESIA/ANAESTHESIA

Surgery on unanaesthetised foetuses of ewes given epidural anaesthesia alone elicits strong leg, trunk and/or neck movements in the foetus, especially after 120 days gestation (Mellor and Gregory, 2003). These movements can make it difficult to carry out surgery on the foetus; therefore, epidural anaesthesia alone is rarely used to provide maternal anaesthesia and analgesia in experimental models. However epidural or intrathecal drug administration can be a useful adjunct to volatile agent anaesthesia in the dam, and may contribute to a balanced anaesthetic technique. Studies in human demonstrate that low doses of intrathecal or epidural opioids and local anaesthetics

are not associated with adverse neonatal effects (Capogna and Camorcia, 2004).

VIII. PREVENTION OF POST-OPERATIVE PRE-TERM LABOUR

Pre-term labour is the most common complication of foetal surgery. No single anaesthetic agent has been implicated as a causative factor and it is more likely that stress response of the dam to surgery results in physiological changes that can trigger pre-term labour. Continued progesterone secretion is essential for the maintenance of pregnancy in mammals, but there are differences in the principal site of progesterone secretion between species. In sheep, similar to human, after approximately the first 55 days of pregnancy, the placenta produces sufficient progesterone to maintain pregnancy, whereas the corpus luteum is essential for progesterone secretion and maintenance of pregnancy in, for example, swine, cattle, goat and horses. The source of progesterone will determine the efficacy of some drugs (e.g. NSAIDs) to reduce the potential for pre-term labour in different species.

A. Key Point 7: Prevention of Pre-Term Parturition

Strategies should be adopted to reduce the risk of pre-term labour after foetal surgery. Optimising the anaesthesia regimen by moderating the stress response in the dam and foetus, combined with reducing post-operative pain in the dam, can contribute to a reduced likelihood of abortion (Goodman, 2002). The applicability of specific pharmacological therapies such as NSAIDs and tocolytics is species dependent, and prior review of the current literature pertaining to the individual species is advised.

IX. FUNCTIONAL MATURITY OF KEY ORGAN SYSTEMS IN NEWBORN ANIMALS

Across species there are huge differences in the stage of maturation of the animal at birth. In marsupial species the young are born very immature and complete their embryonic development in the maternal pouch (marsupium). Relative to marsupial species, rats are more mature at birth, but are still neurologically immature, hairless, blind, and therefore completely dependent on their mother to feed and protect them. In contrast, lambs and other domesticated herbivores are neurologically precocious at birth. They are born with wool or hair covering their body, open eyes, and are able to stand and run very shortly after birth. These differences have impact on the approaches to anaesthesia of the newborn animal.

Profound changes in physiology occur in every animal at birth. In particular, the cardiovascular and respiratory systems must rapidly adapt to the environment outside the uterus and to gas exchange occurring in the lungs rather than the placenta. Although physiological changes continue after birth over the following days and weeks, the magnitude and speed of these changes slows with increasing age. Anaesthesia of neonatal animals in the first 24 hours after birth is uncommon in clinical or research practice. However, it is important to be aware of differences between neonatal and adult physiology in order to make informed decisions about anaesthetic management of neonatal patients. Species differences in neonatal physiology are evident and to a certain extent are influenced by the maturity or precociousness of the neonate at birth. We provide a broad overview of the physiology of organ systems that are significantly influenced by anaesthesia, but avoid an account of physiological changes in individual species as that is beyond the scope of the chapter.

A. Cardiovascular Physiology

The neonate has a low-pressure, low-volume and low-peripheral resistance circulatory system compared to the adult animal (Adelman and Wright, 1985). Consequently, in order to maintain adequate peripheral perfusion in the face of these physiological changes, the neonate has a higher heart rate, cardiac output, plasma volume and central venous pressure compared to the adult. Neonates are more dependent on heart rate to maintain adequate cardiac output than adults and may therefore be more at risk of negative cardiovascular consequences from a relative bradycardia. Sympathetic innervation of the heart is incomplete in some neonates (Mace and Levy, 1983). Although there is evidence for structural maturity of the parasympathetic nervous system, the reduced responsiveness of neonatal heart rate to atropine suggests that vagal tone is reduced compared to adults (Fox, 1966; Mace and Levy, 1983). Hypoxia also causes a bradycardia in neonates (Stowe et al., 1985; Swann et al., 1954), which is in direct contrast to the effect of hypoxia in adults. It is likely that the incomplete maturity of the autonomic nervous system reduces the ability of the neonatal cardiovascular system to respond to physiological stresses such as the cardiovascular effects of most anaesthetic drugs.

B. Respiratory System

The mechanisms that control physiological function in the newborn develop before birth but require maturation in the postnatal period (Haddad and Mellins, 1984). Neonates show a biphasic response to hypoxia: initially hypoxia causes an increase in minute ventilation, which is followed by a return to baseline levels if hypoxia persists (Haddad and Mellins, 1984; Nock et al., 2004). The early excitatory phase of the hypoxic ventilatory response is caused by peripheral chemoreceptor stimulation (Miller and Martin, 1998). The decline in

ventilation is thought to be secondary to hypoxaemia-induced central depression of respiration overriding the initial peripheral chemoreceptor stimulation (Hanson and Kumar, 1994). This may make neonates more vulnerable to apnoea, due to hypoxic respiratory depression impairing the ventilatory response to apnoeic periods.

The compliance of the chest wall is higher in neonates compared to adults and decreases during development (Papastamelos et al., 1995). Neonatal differences between chest wall and lung compliance predispose the neonate to alveolar collapse because of difficulties in passively maintaining residual lung volume (Papastamelos et al., 1995). In order to maintain functional residual capacity, neonates adopt an augmented breathing pattern with a high frequency of respiration combined with a relatively long expiratory time (Frappell and MacFarlane, 2005). Anaesthesia may negatively influence gas exchange in neonates due to the respiratory depressant effects of most anaesthetic agents. The expiratory resistance imposed by some anaesthesia circuits may also further impair ventilation in spontaneously breathing animals.

C. Urinary System

There is significant variation in the degree of renal maturation at birth across species. Renal function reaches maturity in the first 2 weeks after birth in ruminants and pigs (Baggot and Short, 1984), whereas in other domestic species such as horses and dogs renal function matures over the first 4 weeks (Baggot and Short, 1984). Individual species differences will influence the rate of changes in renal function with age. However generally in neonates renal blood flow is directly correlated with arterial blood pressure, and adult control of renal blood flow by angiotensin secretion is not fully developed at birth (Kleinman and Reuter, 1973). Neonates compared to adults are also less able to concentrate or dilute urine and are more at risk of fluid derangements caused by anaesthesia and surgery. Functional immaturity of the kidneys decreases the renal excretion of polar drugs and drug metabolites, which may alter the pharmacokinetics of anaesthetic and analgesic drugs.

D. Hepatobiliary System

During pregnancy the placenta carries out many of the functions performed by the liver in the adult animal. During the first week after birth dramatic changes in hepatic physiology occur, coupled with the loss of umbilical blood flow, increasing hepatic portal vein flow and closure of the ductus venosus (Gow et al., 2001). The hepatic expression of P₄₅₀ cytochromes matures and changes during the early neonatal period (Gow et al., 2001) and the glucuronide metabolic pathway is not fully developed for at least 6 weeks. The liver is therefore functionally immature at birth and functionality increases over the subsequent weeks, although the rate of maturation varies between species

(Baggot and Short, 1984). Clinically this results in decreased hepatic metabolism of many anaesthetic and analgesic drugs, and drug doses should be adjusted accordingly. The proportionally larger blood volume of neonatal animals compared to adults will also increase the volume of distribution and therefore pharmacokinetics of some drugs.

X. ANAESTHESIA OF NEONATAL ANIMALS

Clearly the approach to anaesthesia of the neonate will be determined by the age, species and size of the animal coupled with a consideration of the procedure to be carried out. Smaller animals, such as neonatal mice and rats, pose challenges to anaesthesia based on size alone, resulting in practical difficulties such as establishing IV access and airway management. A comprehensive guide to neonatal anaesthesia of all species is beyond the scope of this chapter; therefore, we will focus on general principles that can be applied across species to all neonates.

A. Key Point 8: Balanced Anaesthesia

General anaesthesia can be defined as a reversible, drug-induced loss of consciousness associated with a lack of responsiveness to noxious stimulation. The three essential components of anaesthesia, termed the triad of anaesthesia, are hypnosis, muscle relaxation and analgesia. Together these elements ensure that the patient is unconscious, that adequate muscle relaxation is present to allow the surgical procedure to be carried out and that analgesia is provided to reduce pain resulting from the surgical intervention after the end of anaesthesia. No single anaesthetic agent is able to provide all elements of the anaesthesia triad. Therefore, the modern approach adopted by anaesthetists is the principle of balanced anaesthesia, that is, using different classes of drugs in combination, so that the dose of each individual agent can be reduced. Since the side effects associated with most anaesthetic agents are also dose related, balanced anaesthesia can result in a more cardiovascularly stable anaesthesia protocol. A clinical example of balanced anaesthesia for orthopaedic surgery in dogs is pre-medication with a sedative and analgesic drug combination (e.g. acepromazine and morphine), induction with an IV hypnotic agent (e.g. propofol) and maintenance of anaesthesia with a volatile agent combined with a continuous rate IV infusion of a potent opioid. This multi-modal approach allows the dose of volatile agent to be reduced and provides better cardiovascular stability and analgesia compared to using a volatile agent alone.

B. Drug Selection

The majority of anaesthetic drugs are metabolised in the liver; therefore, the half-life of most anaesthetic drugs will be longer

in neonates compared to adults due to the immaturity of this organ (see Section IX.D). In order to avoid the detrimental effects of a prolonged recovery from anaesthesia it is advisable to choose short acting drugs for induction and maintenance of anaesthesia. Drug doses must also be adjusted to account for a more prolonged duration of action, particularly when giving repeated doses or a continuous rate infusion of injectable agents. Differences between the neonatal and adult blood–brain barrier may also contribute to altered dose requirements. Propofol is a potent lipophilic anaesthetic agent, formulated in 10% soya bean emulsion (Baker and Naguib, 2005), which is more rapidly metabolised than thiopental in adult animals (Short and Bufalari, 1999). Propofol rather than thiopental should be used for induction of anaesthesia in species where IV induction of anaesthesia is possible (Chaffin et al., 1997). Propofol infusion syndrome is a recognised complication of prolonged propofol infusion in paediatric patients, and is characterised by metabolic acidosis, rhabdomyolysis and cardiac failure (Bray, 2002; Coetzee and Coetzer, 2003). The precise aetiology of this syndrome is unknown, although it has been proposed that prolonged propofol administration may induce a deficiency in mitochondrial oxidative processes in this patient population (Coetzee and Coetzer, 2003). Although this syndrome has not been reported in animals, it is possible that prolonged infusions of propofol in neonatal animals may cause similar adverse effects.

Induction and maintenance of anaesthesia with inhalational agents can be a useful technique in neonatal animals because of the minimal requirement for hepatic metabolism of the agents for recovery from anaesthesia. Induction can be achieved by placing the animal in an anaesthetic chamber and increasing the concentration of delivered inhalant agent until the animal is anaesthetised. Placement of an endotracheal tube for delivery of gases and airway maintenance can be difficult in some species. Traumatic intubation of small body weight animals (<1 kg) can cause permanent damage to the trachea or larynx, so that the advantages of orotracheal intubation must be balanced against the risk of airway damage. Narrow diameter endotracheal tubes also pose a high resistance to respiration and are at risk of obstruction from bronchial secretions. A tracheotomy may be a suitable alternative to endotracheal intubation in some circumstances. Inhalant agents can also be delivered via an anaesthesia breathing system and face mask. It is important that the face mask is tightly fitting to minimise exposure of staff to anaesthetic gases, and systems to scavenge waste anaesthesia gases must be used. Halothane, isoflurane and sevoflurane are the three most commonly used volatile agents in veterinary anaesthesia. The three agents have different physicochemical properties, particularly with regard to blood–gas solubility. Sevoflurane has the lowest and halothane the highest solubility in blood, such that the time required for induction and recovery from anaesthesia is in the following order: sevoflurane > isoflurane > halothane. Halothane is also more fat soluble than the other two agents and undergoes significant liver metabolism, factors which may also slow recovery

after prolonged halothane anaesthesia. In order to minimise the duration of recovery from anaesthesia in neonates, it is advantageous to choose isoflurane or sevoflurane rather than halothane for volatile agent anaesthesia.

Ketamine is widely used in human neonates for anaesthesia and sedation and few adverse effects have been reported (Green et al., 2001; Pees et al., 2003). In adults, ketamine has a favourable cardiovascular profile because of its sympathomimetic effects. The autonomic nervous system is not fully mature at birth; however, studies in pre-term infants suggested that ketamine provided better cardiovascular stability compared to the volatile anaesthetic agents (Friesen and Henry, 1986). Ketamine can be given intravenously or intramuscularly (which is advantageous if IV access is problematic) and can be used to provide a short duration (30–40 minutes) of general anaesthesia. Most species are very sensitive to the central nervous system excitatory effects of ketamine, so that it should be combined with a sedative to prevent overt excitation. Midazolam is a suitable sedative to combine with ketamine, and only has minimal effects on cardiovascular function.

C. Key Point 9: Monitoring During Anaesthesia

Monitoring during anaesthesia of neonates of all species is vital to warn of impending complications and allow early intervention. Manual monitoring of pulse rate and quality and observation of respiration is easy and simple in animals heavier than 1–2 kg. Use of monitoring tools such as electrocardiography, blood pressure measurement, pulse oximetry, capnometry and body temperature provides more detailed and precise information about the physiological status of the patient during anaesthesia and are useful techniques for smaller animals where the manual monitoring of parameters is more challenging. The risk of physiological derangements is greater during longer and more invasive procedures in sicker animals, so that the importance of using monitoring equipment is greater in this patient group. Monitoring equipment must be suitable for the size of the individual animal. Apparatus used in adult cats and dogs is usually suitable for use in neonates of these species, as well as some foals, calves and pigs (depending on size). Specialised equipment tailored to the small size and physiological variables (such as heart rate) is required for neonatal rats and mice.

XI. SUPPORTIVE MEASURES DURING NEONATAL ANAESTHESIA

A. Body Temperature

Neonatal animals are usually at a higher risk of hypothermia than adults, and smaller animals, due to their relatively larger surface area to volume ratio, are more susceptible to

hypothermia than are larger animals. In the first few days after birth the physiological adaptations to cold, such as vasoconstriction and shivering, are poorly developed (Lyon et al., 1997). Anaesthesia further predisposes the neonate to hypothermia because of the depressant effects of anaesthetic agents on the thermoregulatory centre and the lack of muscle activity. Significant hypothermia (body temperature $\leq 35^{\circ}\text{C}$) during anaesthesia has a wide range of deleterious effects on the body. The dose requirement of anaesthetic agents is reduced, making inadvertent anaesthetic overdose more likely unless this is taken into account during drug administration. The rate of drug metabolism will also be reduced, contributing to a more prolonged recovery from anaesthesia. Negative cardiovascular effects include bradycardia, a predisposition for cardiac arrhythmias, and impaired blood clotting, which may result in increased blood loss during surgery. Monitoring body temperature is vital in order to prevent and manage hypothermia during anaesthesia in neonates. Reducing heat loss by increasing the ambient environmental temperature and ensuring the animal does not lie on cold surfaces are vital to prevent heat loss. Care should also be taken during preparation of the skin for surgery to prevent excessive wetting of the body with cold fluids. Measures to maintain normothermia during anaesthesia include use of forced air-warming devices (for example a Bair Hugger[®]), heating blankets and wrapping the animal in an insulating material. Most of these devices can be easily modified for use in small animals such as rodents. Hyperthermia and skin burns can occur due to overzealous heating and lack of attention to body temperature monitoring, particularly because the animal is immobile and unable to move away from direct heat sources. Measures to prevent skin burns (particularly when using heating devices in hairless animals) must be adopted.

B. Blood Glucose

Blood glucose concentration is under tight metabolic control and is maintained within normal limits by glycogenolysis, gluconeogenesis, glycolysis and insulin/glucagon secretion. In the first few hours after birth, neonates are at high risk of hypoglycaemia because of limited glycogen stores at birth combined with the cessation of placental glucose supply at birth (Mellor and Cockburn, 1986). This is especially so when colostrum or milk intake is inadequate. Anaesthesia further increases the risk of hypoglycaemia in all neonates because feeding is suspended during the period of anaesthesia. Clinical signs of hypoglycaemia, such as changes in consciousness, can also not be considered during anaesthesia to act as a warning sign of impending hypoglycaemia.

Monitoring of blood glucose concentration during anaesthesia is important. Portable hand-held glucometers developed for use in human diabetic patients are recognised to be reasonably accurate in man (compared to conventional laboratory testing) and are a useful bedside monitor to use in theatre (Devreese and

Leroux-Roels, 1993). Only tiny (1 drop) amounts of blood are required for each test, which can be collected easily and repeatedly during anaesthesia of larger neonates. The frequency of testing can be adjusted depending on the stability of the measured blood glucose concentration. Glucose can be given by parenteral injection or, preferably, IV infusion to raise blood glucose concentration when hypoglycaemia is detected; formulae are available to calculate the required infusion rate of glucose (mmol/(kg h)) depending on blood glucose concentration. As the risk of hypoglycaemia remains until the animal is able to resume normal feeding from the dam, monitoring of blood glucose should continue through the immediate post-operative period. Additional nutritional support can be provided to larger neonates by tube feeding maternal milk or colostrum via the mouth into the distal oesophagus. This should not be undertaken until the neonate is able to swallow in order to reduce the risk of aspiration associated with this intervention.

XII. POST-OPERATIVE PERIOD

The recovery period is recognised to be a relatively high-risk period in veterinary anaesthesia. The cardiovascular and respiratory side effects of anaesthetic drugs remain until the animal is fully conscious, yet during the recovery period animals are often not monitored or observed and supportive measures to prevent hypothermia, hypovolaemia and hypoxia are commonly not implemented. Derangements in fluid and energy balance may persist until the animal is able to maintain normal fluid and electrolyte balance and food intake. Continuous observation and monitoring during the recovery period is vital to prevent or manage complications. Oxygen should be supplemented using a face mask or oxygen tent until the animal is fully awake. An incubator can be a good environment in which to recover small neonatal animals. The environmental temperature can be controlled to prevent hypothermia and the air in the incubator can easily be enriched with oxygen to make an oxygen tent. Pain should also be frequently assessed during the post-operative period using behavioural indicators appropriate for that species.

XIII. NEONATAL ANALGESIA

Traditionally, there has been a reluctance to use analgesics in neonates because of concern about altered drug pharmacokinetics that leads to drug overdose. However, the importance of adequate pain management in neonates is now recognised, particularly in human medicine (Anand and Scalzo, 2000). The potential for early pain experiences to alter the developing nervous system and change pain perception to future painful stimuli is accepted, although precisely how long these alterations in pain processing persist is unknown (Taddio et al., 1997).

Moreover, such effects have yet to be convincingly demonstrated (Moiniche et al., 2002).

Behavioural assessment of pain is difficult in neonatal animals. Recognising pain behaviour in adult animals is problematic (Moloney and Kent, 1997), and neonates of any given species may be insufficiently mature to show the same behavioural response to pain as the adult. However, assessing pain using dynamic interaction with the patient and application of gentle pressure at the site of tissue injury is important. Response to pain assessment combined with inferred knowledge about the painfulness of the procedure that was carried out can improve decision-making about provision of post-operative analgesia. This can result in better post-operative pain management in neonatal animals.

Neonates present a number of challenges in the provision of effective analgesia in the peri-operative period. In order to optimise pain management in neonates, it is useful to apply the same principles utilised in adults, namely multi-modal analgesia, pre-emptive analgesia and regular assessment of pain-related behaviour. Neonatal rodents present particular challenges for pain assessment due to their small size and lack of active behaviours (Henare et al., 2008). These animals are moderately immature at birth and recent evidence suggests that these animals are not able to experience pain as neonates (Diesch et al., 2007).

A. Key-Point 10: Multi-Modal Analgesia

The pain pathway is complex, with multiple neurotransmitters and receptors involved in the transmission of noxious information from the periphery to the central nervous system and cortex. It is therefore extremely difficult to achieve effective analgesia by using a single class of analgesic drug alone. Multi-modal analgesia uses different classes of analgesic drugs, which act at different sites in the pain pathway, in combination. The side effects of different drug classes are usually different, so that, with the exception of NSAIDs and steroids, combining drug classes will also not lead to exacerbation of drug side effects. Synergism between drug classes (e.g. between α_2 adrenoreceptor agonists and opioids) also allows the dose of individual agents to be reduced when used in combination, which may be advantageous.

B. Key Point 11: Pain Assessment

Despite the difficulties of pain assessment in neonates across species, assessment of pain is integral to effective pain management. Abnormal behaviour in the post-operative period is commonly related to pain and should be assumed to be so unless proven otherwise. Changes in behaviour in response to analgesic drug administration can be used to confirm whether behaviours are pain related and used as a basis for further analgesic drug administration.

C. Opioids

Dosing regimens of opioids for neonates of different species have not been investigated experimentally and there is a paucity of information in the clinical literature. An increased sensitivity of puppies to the sedative and respiratory depressant effects of opioids is reported (Luks et al., 1998), and this may apply to other species. It is advisable to initially give low doses of opioids (e.g. half adult dose), and increase the dose depending on the level of analgesia achieved. This is a safer way to achieve effective analgesia without excessive side effects. Side effects are less likely to occur following partial opioid agonists such as buprenorphine, although the analgesic efficacy of partial agonists is also less than that of full agonists such as morphine. Reversal of excessive opioid side effects can be achieved with naloxone (an OP3 receptor antagonist), although administration of naloxone may potentially reverse endogenous opioid analgesia and potentially expose the neonate to pain.

D. Non-Steroidal Anti-inflammatory Drugs

NSAIDs form a valuable component to peri-operative pain control in adult animals; however, recommendations for NSAID administration to neonates vary between species. NSAIDs are not advised in puppies and kittens less than 6 weeks of age because the immaturity of the hepatorenal system increases the risk of adverse side effects in these species (Mathews, 2005). Compared to cats and dogs, cattle and horses appear to be at a reduced risk of renal and gastrointestinal side effects from NSAIDs, and this class of drugs is commonly administered to horses and calves less than 1-month-old (Crisman et al., 1996; Semrad, 1993). The pharmacokinetics of flunixin meglumine and ketoprofen in foals younger than 24 hours old have been studied and are altered compared to adults (Crisman et al., 1996; Wilke et al., 1998). This is likely to be the case in other neonatal species and requires dose adjustment to prevent overdose and obtain therapeutic plasma concentrations.

XIV. CONCLUDING COMMENTS

As outlined in the above sections, we have attempted to introduce and discuss important concepts relevant to anaesthesia and analgesia in the foetus and neonate. We did not intend to be exhaustive in our coverage of individual drug protocols or species. We hope that this chapter will form a secure foundation of the principles peculiar to anaesthesia and analgesia of the foetus and neonate, which will guide researchers in their selection and administration of anaesthetic protocols in a wide variety of situations.

REFERENCES

- Abboud, T., Zhu, J., Richardson, M., Silva, E.P.D., and Donovan, M. (1995). Intravenous propofol vs. thiamylal-isoflurane for caesarian section, comparative maternal and neonatal effects. *Acta Anaesthesiol. Scand.* **39**, 205–209.
- Adelman, R., and Wright, J. (1985). Systolic blood pressure and heart rate in the growing beagle puppy. *Dev. Pharm. Ther.* **8**, 396–401.
- Almeida, T., Rozenblatt, S., and Tufik, S. (2004). Afferent pain pathways: A neuroanatomical review. *Brain Res.* **1000**, 40–56.
- Alon, E., Ball, R., Gillie, M., Parer, J., Rosen, M., and Shnider, S. (1993). Effects of propofol and thiopental on maternal and fetal cardiovascular and acid-base variables in the pregnant ewe. *Anesthesiology* **78**, 562–576.
- Amateau, S.K., and McCarthy, M.M. (2004). Induction of PGE2 by estradiol mediates masculinization of sex behavior. *Nat. Neurosci.* **7**, 643–650.
- Anand, K., and Scalzo, F. (2000). Can adverse neonatal experiences alter brain development and subsequent behaviour?. *Biol. Neonate* **77**, 69–82.
- Andaluz, A., Trasserras, O., and Garcia, F. (2005). Maternal and fetal effects of propofol anaesthesia in the pregnant ewe. *Vet. J.* **170**, 77–83.
- Bachman, C., Biehl, D., Sitar, D., Cumming, M., and Pucci, W. (1986). Isoflurane potency and cardiovascular effects during short exposures in the foetal lamb. *Can. Anaesth. Soc. J.* **33**, 41–47.
- Baggot, J., and Short, C. (1984). Drug disposition in the neonatal animal, with particular reference to the foal. *Equine Vet. J.* **16**, 364–367.
- Baker, M., and Naguib, M. (2005). Propofol: The challenges of formulation. *Anesthesiology* **103**, 860–876.
- Bennet, L., Johnston, B., and Gluckman, P. (1986). The central effects of morphine on fetal breathing movements in the fetal sheep. *J. Dev. Physiol.* **8**, 297–305.
- Boubred, F., Vendemmia, M., Garcia-Meric, P., Buffat, C., Millet, V., and Simeoni, U. (2006). Effects of maternally administered drugs on the fetal and neonatal kidney. *Drug Saf.* **29**, 397–419.
- Bray, R. (2002). The propofol infusion syndrome in infants and children: Can we predict the risk? *Curr. Opin. Anaesthesiol.* **15**, 339–342.
- Capogna, G., and Camorcia, M. (2004). Epidural analgesia for childbirth: Effects of newer techniques on neonatal outcome. *Paediatr. Drugs* **6**, 375–386.
- Chaffin, M., Walker, M., McArthur, N., Perris, E., and Matthews, N. (1997). Magnetic resonance imaging of the brain of normal neonatal foals. *Vet. Radiol. Ultrasound* **38**, 102–111.
- Clarke, A., Wittwer, D., Abbott, D., and Schneider, M. (1994). Long term effects of prenatal stress on HPA axis activity and in juvenile rhesus monkeys. *Dev. Psychobiol.* **27**, 257–269.
- Coetzer, J., and Coetzer, M. (2003). Propofol in paediatric anaesthesia. *Curr. Opin. Anaesthesiol.* **16**, 285–290.
- Crisman, M., Wilcke, J., and Sams, R. (1996). Pharmacokinetics of flunixin meglumine in healthy foals less than twenty-four hours old. *Am. J. Vet. Res.* **57**, 1759–1761.
- Crossley, K., Nicol, M., Hurst, J., Walker, D., and Thornburn, G. (1997). Suppression of arousal by progesterone in fetal sheep. *Reprod. Fertil. Dev.* **9**, 767–773.
- Davis, D., Speziali, G., Wagerie, L., Heckman, J., and Russo, P. (1995). Effects of halothane on the immature lamb heart. *Ann. Thorac. Surg.* **59**, 695–698.
- Devreese, K., and Leroux-Roels, G. (1993). Laboratory assessment of five glucose meters designed for self-monitoring of blood glucose concentration. *Eur. J. Clin. Chem. Clin. Biochem.* **31**, 829–837.
- de Vries, J., Visser, G., and Prectl, H. (1988). The emergence of fetal behaviour: III. Individual differences and consistencies. *Early Hum. Dev.* **74**, 85–103.
- Diesch, T.J., Mellor, D.J., Johnson, C.B., and Lentle, R.G. (2007). Responsiveness to painful stimuli in anaesthetised newborn and young animals of varying neurological maturity (wallaby joeys, rat pups and lambs). In “Proceedings of the Sixth World Congress on Alternatives and Animal Use in the Life Sciences—Review Progress Made Towards the 3Rs.” Abstracts. 135 pp.
- Doyle, N., Gardner, M., Wells, L., Qualls, C., and Papile, L. (2005). Outcome of very low birth weight infants exposed to antenatal indomethacin for tocolysis. *J. Perinatol.* **25**, 336–340.
- Dunwiddie, T., and Masino, S. (2001). The role and regulation of adenosine in the central nervous system. *Annu. Rev. Neurosci.* **24**, 31–55.
- Eggink, A., Roelofs, L., Feitz, W., Wijnen, R., Mullaart, R., Grotenhuis, J., van Kuppevelt, T., Ellingson, R.J., and Rose, G.H. (1970). Ontogenesis of the electroencephalogram. In “Developmental Neurobiology.” (W. Himwich, ed.), pp 441–474. Charles C Thomas, Springfield, IL.
- Ellingson and Rose, R. (1970). J Ontogenesis of evoked potentials. In “Developmental Neurobiology.” (W.A. Himwich Ed.). Charles C. Thomas, Springfield, III.
- Ferri, R., Chiamonti, R., Elia, M., Musumeci, S., Ragazzoni, A., and Stam, C. (2003). Nonlinear EEG analysis during sleep in premature and full-term newborns. *Clin. Neurophysiol.* **114**, 1176–1180.
- Fischer, G., Rolley, J., and Eder, H. (2000). Treatment of opioid-dependent pregnant women with buprenorphine. *Addiction* **95**, 239–244.
- Fisk, N., Gitau, R., Teixeira, J., Giannakouloupoulos, X., Cameron, A., and Glover, V. (2001). Effect of direct fetal opioid analgesia on fetal hormonal and hemodynamic stress response to intrauterine needling. *Anesthesiology* **95**, 828–835.
- Fox, M. (1966). Developmental physiology and behaviour. In “Canine Pediatrics.” (M. Fox and W. Himwich, eds.), pp 22–25. Charles C Thomas, Springfield, IL.
- FrapPELL, P., and MacFarlane, P. (2005). Development of mechanics and pulmonary reflexes. *Respir. Physiol. Neurobiol.* **149**, 143–154.
- Friesen, R., and Henry, D. (1986). Cardiovascular changes in preterm neonates receiving isoflurane, halothane, fentanyl, and ketamine. *Anesthesiology* **64**, 238–242.
- Funquist, P.M., Nyman, G.C., Lofgren, A.J., and Fahlbrink, E.M. (1997). Use of propofol-isoflurane as an anaesthetic regimen for cesarean section in dogs. *J. Am. Vet. Med. Assoc.* **211**, 313–317.
- Giannakouloupoulos, X., Sepulveda, W., Kourtis, P., Glover, V., and Fisk, N. (1994). Fetal plasma cortisol and beta-endorphin response to intrauterine needling. *Lancet* **344**, 77–81.
- Giannakouloupoulos, X., Teixeira, J., Fisk, N., and Glover, V. (1999). Human fetal and maternal noradrenaline responses to invasive procedures. *Pediatr. Res.* **45**, 494–499.
- Glover, V., and Fisk, N. (1999). Fetal pain: Implications for research and practice. *Br. J. Obstet. Gynaec.* **106**, 881–886.
- Goodman, S. (2002). Anaesthesia for non obstetric surgery in the pregnant patient. *Semin. Perinatol.* **26**, 135–45.
- Gow, P., Ghabrial, H., Smallwood, R., Morgan, D., and Ching, M. (2001). Neonatal hepatic drug elimination. *Pharmacol. Toxicol.* **88**, 3–15.
- Green, S., Denmark, T., Cline, J., Roghair, C., Allah, S.A., and Rothrock, S. (2001). Ketamine sedation for pediatric critical care procedures. *Pediatr. Emerg. Care* **17**, 244–248.
- Gregory, G., Wade, J., Beihl, D., Ong, B., and Sitar, D. (1983). Fetal anaesthetic requirement (MAC) for halothane. *Anaesth. Analg.* **62**, 9–14.
- Haddad, G., and Mellins, R. (1984). Hypoxia and respiratory control in early life. *Annu. Rev. Physiol.* **46**, 629–643.
- Hanson, M., and Kumar, P. (1994). Chemoreceptor function in the fetus and neonate. In “Arterial Chemoreceptors: Cell to System.” (R. O’Regan, ed.), pp 99–108. Plenum Press, New York.
- Henare, S.J., Mellor, D.J., Lentle, R.G., and Moughan, P.J. (2008). An appraisal of the strengths and weaknesses of newborn and juvenile rat models for researching gastrointestinal development. *Lab. Anim.* (in press).
- Hirst, J., Egodagamage, K., and Walker, D. (2000). Effect of a neuroactive steroid infused into the cerebral ventricles of fetal sheep in utero using small infusion volumes. *J. Neurosci. Methods* **97**, 37–44.
- Hodgson, D., Dunlop, C., Chapman, P., and Smith, J. (2002). Cardiopulmonary effects of xylazine and acepromazine in pregnant cows in late gestation. *Am. J. Vet. Res.* **63**, 1695–1699.

- Houfflin-Debarge, V., Delelis, A., Jaillard, S., Larrue, B., Deruelle, P., Ducloy, A., Puech, F., and Storme, L. (2005). Effects of nociceptive stimuli on the pulmonary circulation in the ovine fetus. *Am. J. Physiol. Regul. Integr. Comp. Physiol.* **288**, R547–R553.
- Hunter, C.J., Bennet, L., Power, G.G., Roelfsema, V., Blood, A.B., Quaedackers, J.S., George, S., Guan, J., and Gunn, A.J. (2003). Key neuroprotective role for endogenous adenosine A1 receptor activation during asphyxia in the fetal sheep. *Stroke* **34**, 2240–2245.
- IASP (2004). IASP Pain Terminology. <http://www.iasp-pain.org/terms-p.html>
- Jansen, A., and Chernick, V. (1991). Fetal breathing and development of control of breathing. *J. Appl. Physiol.* **70**, 1431–1446.
- Jansen, C., Lowe, K., and Nathanielsz, P. (1984). The effects of xylazine on uterine activity, fetal and maternal oxygenation, cardiovascular function, and fetal breathing. *Am. J. Obstet. Gynecol.* **148**, 386–390.
- Jedruch, J., Gajewski, Z., and Kuussaari, J. (1989a). The effect of detomidine hydrochloride on the electrical activity of the uterus in pregnant mares. *Acta Vet. Scand.* **30**, 307–311.
- Jedruch, J., Gajewski, Z., and Ratajska-Michalczak, K. (1989b). Uterine motor responses to an alpha2 adrenergic agonist medetomidine hydrochloride in bitches during the end of gestation and post-partum period. *Acta Vet. Scand.* **85**, 129–134.
- Kleinman, L., and Reuter, J. (1973). Maturation of glomerular blood flow distribution in the newborn dog. *J. Physiol.* **228**, 91–103.
- Kostovic, I., and Goldman-Rakic, P. (1984). Development of prestriate visual projections in the monkey and human fetal cerebrum revealed by transient cholinesterase staining. *J. Neurosci.* **4**, 25–42.
- Kubonoya, K., and Power, G. (1997). Plasma adenosine responses during repeated episodes of umbilical cord occlusion. *Am. J. Obstet. Gynecol.* **177**, 395–401.
- Leader, L., Stevens, A., and Lumbers, E. (1988). Measurement of fetal responses to vibroacoustic stimuli. Habituation in fetal sheep. *Biol. Neonate* **53**, 73–85.
- Lee, B., Hirst, J., and Walker, D. (2002). Prostaglandin D synthase in the prenatal ovine brain and effects of its inhibition with selenium chloride on fetal sleep/wake activity in utero. *J. Neurosci.* **22**, 5679–5686.
- Lee, S.J., Peter Ralston, H.J., Drey, E.A., Partridge, J.C., and Rosen M.A. (2005). Fetal pain: A systematic multidisciplinary review of the evidence. *J. Am. Med. Assoc.* **294**, 947–954.
- Loftus, J., Hill, H., and Cohen, S. (1995). Placental transfer and neonatal effects of epidural sufentanil and fentanyl administered with bupivacaine during labor. *Anesthesiology* **83**, 300–308.
- Luks, A., Zwass, M., and Brown, R. (1998). Opioid-induced analgesia in neonatal dogs: Pharmacodynamic differences between morphine and fentanyl. *J. Appl. Physiol.* **284**, 136.
- Lyon, A., Pikaar, M., Badger, P., and McIntosh, N. (1997). Temperature control in very low birthweight infants during the first five days of life. *Arch. Dis. Child Fetal Neonatal. Ed.* **76**, F47–F50.
- Ma, Q., and Woolf, C. (1995). Noxious stimuli induce an N-methyl-D-aspartate receptor dependent hypersensitivity of the flexion withdrawal reflex to touch: Implications for the treatment of mechanical allodynia. *Pain* **61**, 383–390.
- Mace, S., and Levy, M. (1983). Neural control of heart rate: A comparison between puppies and adult animals. *Pediatr. Res.* **17**, 422–428.
- Majewska, M. (1992). Neurosteroids: Endogenous bimodal modulators of the GABAA receptor. Mechanisms of action and physiological significance. *Prog. Neurobiol.* **38**, 379–395.
- Mallard, E.C., Gunn, A.J., Williams, C.E., Johnston, B.M., and Gluckman, P.D. (1992). Transient umbilical cord occlusion causes hippocampal damage in the fetal sheep. *Am. J. Obstet. Gynecol.* **167**, 1423–1430.
- Martin, D.D. (1996). Cesarean section patients. In “Veterinary Anaesthesia.” (J.C. Thurmon, W.J. Tranquilli, and G.J. Benson, eds.), 3rd ed. Williams and Wilkins, Baltimore.
- Mathews, K. (2005). Analgesia for the pregnant, lactating and neonatal to pediatric cat and dog. *J. Vet. Emerg. Crit. Car.* **15**, 273–284.
- McClaine, R., Uemura, K., de le Fuente, S., Manson, R., Booth, J., White, W., Campbell, K., McClaine, D., Benni, P., Eubanks, W., and Reynolds, J. (2005). General anaesthesia improves fetal cerebral oxygenation without evidence of subsequent neuronal injury. *J. Cereb. Blood Flow Metab.* **25**, 1060–1069.
- McLaughlin, P., Zagon, I., and White, W. (1978). Perinatal methadone exposure in rats. Effects on body and organ development. *Biol. Neonate* **34**, 48–54.
- Meaney, M., and Aitken, D. (1985). The effects of early postnatal handling on hippocampal glucocorticoid receptor concentrations: Temporal parameters. *Brain Res.* **354**, 301–304.
- Mellor, D. (1988). Integration of perinatal events, pathophysiological changes and consequences for the newborn lamb. *Br. Vet. J.* **144**, 552–569.
- Mellor, D., and Cockburn, F. (1986). A comparison of energy metabolism in the newborn infant, piglet and lamb. *Q. J. Exp. Physiol.* **71**, 361–379.
- Mellor, D., and Diesch, T. (2006). Onset of sentience: The potential for suffering in fetal and newborn farm animals. *Appl. Anim. Behav. Sci.* **100**, 48–57.
- Mellor, D., and Diesch, T. (2007). Birth and hatching: Key events in the onset of ‘awareness’ in lambs and chicks. *N. Z. Vet. J.* **55**, 51–60.
- Mellor, D., Diesch, T., Gunn, A., and Bennet, L. (2005). The importance of “awareness” for understanding fetal pain. *Brain Res. Rev.* **49**, 455–471.
- Mellor, D., and Gregory, N. (2003). Responsiveness, behavioural arousal and awareness in fetal and newborn lambs: Experimental, practical and therapeutic implications. *N. Z. Vet. J.* **51**, 2–13.
- Mellor, D., and Stafford, K. (2004). Animal welfare implications of neonatal mortality and morbidity in farm animals. *Vet. J.* **168**, 118–133.
- Michejda, M. (1984). Interuterine treatment of spina bifidia: Primate model. *Z. Kinderchir.* **39**, 259–261.
- Miller, M., and Martin, R. (1998). Pathophysiology of apnoea of prematurity. In “Fetal and Neonatal Physiology.” (R. Polin and W. Fox, eds.). W.B. Saunders, Philadelphia.
- Moiniche, S., Kehlet, H., and Dahl, J. (2002). A qualitative and quantitative systematic review of preemptive analgesia for postoperative pain relief: The role of timing of analgesia. *Anesthesiology* **96**, 725–741.
- Moloney, V., and Kent, J. (1997). Assessment of acute pain in farm animals using behavioral and physiological measurements. *J. Anim. Sci.* **75**, 266–272.
- Moore, J., Bill, K., Flynn, R., McKeating, K., and Howard, P. (1989). A comparison between propofol and thiopental as induction agents in obstetric anaesthesia. *Anaesthesia* **44**, 753–757.
- Nanovskaya, T., Deshmukh, S., Brooks, M., and Ahmed, M.S. (2002). Transplacental transfer and metabolism of buprenorphine. *J. Pharmacol. Exp. Ther.* **300**, 26–33.
- Nock, M., DiFore, J., Arko, M., and Martin, R. (2004). Relationship of the ventilatory response to hypoxia with neonatal apnea in preterm infants. *J. Pediatr.* **144**, 291–295.
- Okai, T., Kozuma, S., Shinozuka, N., Kuwabara, Y., and Mizuno, A. (1992). A study on the development of sleep-wakefulness cycle in the human fetus. *Early Hum. Dev.* **29**, 391–396.
- Olthoff, D., and Rohrbach, A. (1998). Sevoflurane in obstetric anaesthesia. *Anaesthetist* **47**, S63–S69.
- Palmisano, B., Mehner, R., Stowe, D., Bosnjak, Z., and Kampine, J. (1994). Direct myocardial effects of halothane and isoflurane. Comparison between adult and infant rabbits. *Anesthesiology* **81**, 718–729.
- Papastamelos, C., Panitch, H., England, S., and Allen, J. (1995). Developmental changes in chest wall compliance in infancy and early childhood. *J. Appl. Physiol.* **78**, 179–184.
- Pees, C., Haas, N., Ewert, P., Berger, F., and Lange, P. (2003). Comparison of analgesic/sedative effect of racemic ketamine and S(+)-ketamine during cardiac catheterization in newborns and children. *Pediatr. Cardiol.* **24**, 424–429.
- Prechtel, H., and Nijhuis, J. (1983). Eye movements in the human fetus and newborn. *Behav. Brain Res.* **10**, 119–124.
- Rexroad, C., and Barb, C. (1978). Contractile response of the uterus of the estrous ewe to adrenergic stimulation. *Biol. Reprod.* **19**, 297–305.

- Rigatto, H. (2004). Control of breathing in fetal life and onset and control of breathing in the neonate. In "Fetal and Neonatal Physiology." (R. Polin, W. Fox, and S. Abman, eds.). W.B. Saunders, Philadelphia.
- Sabik, J., Assad, R., and Hanley, F. (1993). Halothane as an anaesthetic for fetal surgery. *J. Pediatr. Surg.* **28**, 542–546.
- Sakamoto, H., Kirihara, H., Fujiki, M., Miura, N., and Misumi, K. (1997). The effects of medetomidine on maternal and fetal cardiovascular and pulmonary function, intrauterine pressure and uterine blood flow in pregnant goats. *Exp. Anim.* **46**, 67–73.
- Sakamoto, H., Misumi, K., Nakama, M., and Aoki, Y. (1996). The effects of xylazine on intrauterine pressure, uterine blood flow, maternal and fetal cardiovascular and pulmonary function in pregnant goats. *J. Vet. Med. Sci.* **58**, 211–217.
- Santolaya-Forgas, J., Romero, R., and Mehendale, R. (2006). The effect of continuous morphine administration on maternal plasma oxytocin concentration and uterine contractions after open fetal surgery. *J. Matern. Fetal Neonatal Med.* **19**, 231–234.
- Schneider, M., Coe, C., and Lubach, G. (1992). Endocrine activation mimics the adverse effects of prenatal stress on the neuromotor development of the infant primate. *Dev. Psychobiol.* **25**, 427–439.
- Schwab, M., Schmidt, K., Witte, H., and Abrams, M. (2000). Investigation on nonlinear ECoG changes during spontaneous sleep state changes and cortical arousal in fetal sheep. *Cereb. Cortex* **10**, 142–148.
- Semrad, S. (1993). Comparison of flunixin, prednisolone, dimethyl sulfoxide, and a lazaroid (U74389F) for treating endotoxemic neonatal calves. *Am. J. Vet. Res.* **54**, 1517–1522.
- Setoyama, K., Shinzato, T., Misumi, K., Fujiki, M., and Sakamoto, H. (2003). Effects of propofol-sevoflurane anaesthesia on the maternal and fetal haemodynamics blood gases, and uterine activity in pregnant goats. *J. Vet. Med. Sci.* **65**, 1075–1081.
- Shinozuka, N., and Nathanielsz, P.W. (1998). Electrocardiac activity in fetal sheep in the last seven days of gestation. *J. Physiol., Lond.* **513**, 273–281.
- Short, C., and Bufalari, A. (1999). Propofol anaesthesia. *Vet. Clin. North Am. Small Anim. Pract.* **29**, 747–748.
- Siafaka, I., Vadalouca, A., Gatzidou, B., Petropoulos, G., and Salamalekis, E. (1992). A comparative study of propofol and thiopental as induction agents for elective caesarian section. *Clin. Exp. Obstet. Gynecol.* **19**, 93–96.
- Smith, R., Gitau, R., Glover, V., and Fisk, N. (2000). Pain and stress in the human fetus. *Eur. J. Obstet. Gyn.* **92**, 161–165.
- Stowe, D., Bosnjak, Z., and Kampine, J. (1985). Effects of hypoxia on adult and neonatal pacemaker rates. *Obstet. Gynecol.* **66**, 649–656.
- Strumper, D., Gogarten, W., Durieux, M., Hartleb, K., Aken, H.V., and Marcus, M. (2004). The effects of S+ ketamine and racemic ketamine on uterine blood flow in chronically instrumented pregnant sheep. *Anaesth. Analg.* **98**, 497–502.
- Swann, H., Christian, J., and Hamilton, C. (1954). The process of anoxic death in newborn pups. *Surg. Gynecol. Obstet.* **99**, 5–8.
- Swartz, J., Cumming, M., and Biehl, D. (1987). The effect of ketamine anaesthesia on the acidotic fetal lamb. *Can. J. Anaesth.* **34**, 233–237.
- Szeto, H., and Hinman, D. (1985). Prenatal development of sleep-wake patterns in sheep. *Sleep* **8**, 347–355.
- Taddio, A., Katz, J., Ilersich, A., and Koren, G. (1997). Effect of neonatal circumcision on pain response during subsequent routine vaccination. *Lancet* **349**, 599–603.
- Taylor, A., Fisk, N., and Glover, V. (2000). Mode of delivery and subsequent stress response. *Lancet* **355**, 120.
- Taylor, C., Soong, Y., Wu, D., Yee, J., and Szeto, H. (1997a). Morphine stimulates adrenocorticotropin and cortisol release in the late-term ovine fetus. *Pediatr. Res.* **41**, 411–415.
- Taylor, C., Wu, D., Soong, Y., Yee, J., and Szeto, H. (1997b). Dynorphin A 1-13 stimulates ovine fetal pituitary-adrenal function through a novel nonopioid mechanism. *Pharm. Exp. Ther.* **280**, 416–421.
- Uno, H., Lohmiller, L., Thieme, C., Kemnitz, J., Engle, M., Roecker, E., and Farrell, P. (1990). Brain damage induced by prenatal exposure to dexamethasone in fetal rhesus macaques I. Hippocampus. *Dev. Brain Res.* **53**, 157–167.
- van den Pas, M., Nijhuis, J., and Jongsma, H. (1994). Fetal development in uncomplicated pregnancies after 41 weeks of gestation. *Early Hum. Dev.* **40**, 29–38.
- van der Valk, J., Mellor, D., Brands, R., Fischer, R., Gruber, F., Gstraunthaler, G., Hellebrekers, L., Hyllner, J., Jonker, H., Prieto, P., Thalen, M. and Baumans, V. (2004). The humane collection of fetal bovine serum and possibilities for serum-free cell and tissue culture. *Toxicol. In Vitro* **18**, 1–12.
- Watson, C.S., Schaefer, R., White, S.E., Homan, J.H., Fraher, L., Harding, R., and Bocking, A.D. (2002). Effect of intermittent umbilical cord occlusion on fetal respiratory activity and brain adenosine in late-gestation sheep. *Reprod. Fertil. Dev.* **14**, 35–42.
- Watt, I., and Ledingham, I. (1984). Mortality amongst multiple trauma patients admitted to an intensive therapy unit. *Anaesthesia* **39**, 973–981.
- Wilke, J., Crisman, M., Scarratt, W., and Sams, R. (1998). Pharmacokinetics of ketoprofen in healthy foals less than twenty-four hours old. *Am. J. Vet. Res.* **59**, 290–292.
- Wolf, C., and Salter, M. (2000). Neuronal plasticity: Increasing the gain in pain. *Science* **288**, 1765–1769.
- Wunsch, M., Stanard, V., and Schnoll, S. (2003). Treatment of pain in pregnancy. *Clin. Pain J.* **19**, 148–155.
- Yoo, K., Lee, J., Yoon, M., Shin, M., Kim, S., Kim, Y., Song, T., and Lee, J. (2006). The effects of volatile anaesthetics on spontaneous contractility of isolated human pregnant uterine muscle: A comparison among sevoflurane, desflurane, isoflurane, and halothane. *Anaesth. Analg.* **103**, 443–447.

Novel Delivery Systems for Analgesic Drugs in Laboratory Animals

Lisa Krugner-Higby, Lesley J. Smith, and Timothy D. Heath

I. Introduction	609
A. Difficulties of Administering Effective Analgesics in Laboratory Animals	609
B. Why Buprenorphine Is Not Enough?	610
II. Other Approaches to Analgesic Drug Delivery in Laboratory Animals	611
A. Polymers Embedded with Opioid Drugs	611
B. Long-Acting Oral or Transdermal Formulations of Opioid Drugs	611
C. Analgesic Drugs Loaded into Pellets or Osmotic Pumps	612
D. Liposomal Formulations of Analgesic Drugs	613
E. Topical Delivery of NSAIDs and Other Anti-Inflammatory Medications	614
F. Anesthetic Catheters Delivering Continuous Infusions of Local Anesthetics	616
III. Conclusion	616
References	616

I. INTRODUCTION

A. Difficulties of Administering Effective Analgesics in Laboratory Animals

The effective treatment of pain is an integral part of the practice of laboratory animal medicine. However, there are significant barriers to the delivery of the most effective analgesics in laboratory animal species. Opioid drugs that act principally on the mu receptor, such as morphine sulfate, hydromorphone, and oxymorphone, are the most effective drugs for the treatment of somatic or visceral pain (Jaffe and Martin, 1985). In

small rodents such as mice and rats, these drugs have extremely short dosing intervals. For example, the dosing interval for morphine sulfate in mice is q1–2h for conventional subcutaneous (SC) administration (Hawk, 1999). The dosing interval for the same drug in rats is q2–4h. Oxymorphone, an opioid drug with approximately 10 times the potency of morphine sulfate, and hydromorphone, with potency approximately 5 times that of morphine, are empirically recommended to be given q4h (Hawk, 1999; Jaffe and Martin, 1985; Plumb, 1995).

Short dosing intervals for common laboratory species mean that small rodents, which comprise 95–98% of all animals used in biomedical research, must be repeatedly handled and stressed

to receive analgesic medications. Repeated handling also means there are increased opportunities for both animal and human injuries. Repeated dosing increases personnel time necessary for an experiment and places personnel in the animal facility after hours, making facility security more difficult. Short dosing intervals also mean that drug security is more complicated and there are more opportunities for illicit diversion of opioid analgesic drugs. Because of these concerns, these effective analgesics are greatly underutilized in laboratory animal medicine. The response of the research community has been to select analgesic agents that produce acceptable, if not optimal, analgesia and that last longer than the pure μ (mu opioid receptor) agonist drugs. Nonsteroidal anti-inflammatory drugs (NSAIDs), such as carprofen, ketoprofen, and meloxicam, are often used in laboratory animals for mild to moderate pain, but NSAIDs may be associated with gastrointestinal ulceration and hemorrhage, especially with oral dosing (Dial et al., 2005; Papich, 1997). The most commonly used drug for laboratory animals for moderate pain is the partial μ agonist buprenorphine. A PubMed database literature search using the search terms “buprenorphine,” “oxymorphone,” and “hydromorphone,” in the journal *Laboratory Animal Science/Comparative Medicine*, returned 12 citations for buprenorphine and only the same 3 citations each for the other two drugs. Buprenorphine has a slower onset compared to the pure μ agonist analgesics, and a ceiling effect on sedation, hypotension, and respiratory depression (Jaffe and Martin, 1985; Yu et al., 2006). The ceiling effects of buprenorphine mean that it is associated with less severe dose-dependent side effects than pure μ agonist analgesics, but it does not mean that the use of the drug is devoid of such side effects. The very neurochemical characteristics that make buprenorphine an attractive drug for treating pain in laboratory animals also make it less than optimal for some types of pain.

B. Why Buprenorphine Is Not Enough?

In addition to a ceiling on undesirable side effects, buprenorphine has a ceiling effect with respect to the analgesia it provides. Whereas pure μ agonist drugs, such as morphine sulfate, oxymorphone, and hydromorphone, have a linear increase in the amount of analgesia for a given dose of drug, there is a point at which the analgesia provided by buprenorphine does not increase with an increase in the dosage of the drug (Gillingham et al., 2001; Jaffe and Martin, 1985). Therefore, buprenorphine can be problematic in treating more severe forms of pain, such as that from visceral or orthopedic surgeries. The use of higher dosages of buprenorphine to try to treat more severe pain can also be associated with several adverse side effects, including pica, especially in Sprague-Dawley rats (Clark et al., 1997; Thompson et al., 2004), intestinal and urinary bladder ileus, and agitation or profound sedation. High dosages of buprenorphine can also be associated with behavioral changes such as chewing on the feet or tail (autotomy), possibly as a result of opioid-induced histamine release (Gillingham et al., 2001).

The pharmacokinetics of buprenorphine allow for a longer dosing interval than pure μ opioids (q6–12h for mice and q12–24h for rats based on a dosing interval of approximately 2–4 half-lives of the drug in serum) (Table 28-1). The experimentally derived half-life of buprenorphine in the rabbit falls within the 6–12 hours dosing regimen, and it is 8–24 hours in humans. Dogs have been reported to have a serum half-life of buprenorphine of 19.5 hours. This result would indicate a dosing interval of 40–80 hours (Yu et al., 2006). However, dosage of 1.42 mg/kg used in that study was higher than current recommendations of 0.01–0.005 mg/kg for intramuscular, SC, or intravenous (IV) administration in this species (Hawk et al., 2005). The practical concerns of personnel, labor costs, and animal handling are still relevant even at these dosing intervals.

TABLE 28-1

A SUMMARY OF PHARMACOKINETIC STUDIES OF INTRAVENOUSLY ADMINISTERED BUPRENORPHINE REPORTED IN THE LITERATURE

	Yu et al., 2006	Gopoi, 2000	Ohtani, 1994	Ho, 1991	Ho, 1991	Garnett, 1985
Species	Mouse	Rat	Rat	Rabbit	Human	Dog
Dose (mg/kg)	2.4	3	0.6	0.3	0.006	1.42
No. of compartments	3	3	2	3	3	3
λ_1 (per hour)	12.7	8.76	3.76	45.5	31.4	40.8
λ_2 (per hour)	2.13	1.24	0.26	4.74	1.68	1.66
λ_z (per hour)	0.239	0.09	n/a	0.24	0.18	0.036
$t_{1/2z}$ (hour)	2.9	7.7	2.7	2.9	3.9	19.5
Cl (l/h/kg)	4.3	2.8	4.1	1.8	0.269	1.1
V _{ss} (l/kg)	6.5	8.4	1.5	n/a	n/a	n/a

Note: λ_1 , exponent for the first phase; λ_2 , exponent for the second phase; λ_z , exponent for the terminal phase; $t_{1/2z}$, half-life of the terminal phase; Cl, clearance; V_{ss}, volume of distribution at steady state; n/a, not applicable.

Source: Reproduced by permission of *J. Am. Assoc. Lab. Anim. Sci.* and the corresponding author (Yu et al., 2006).

II. OTHER APPROACHES TO ANALGESIC DRUG DELIVERY IN LABORATORY ANIMALS

A. Polymers Embedded with Opioid Drugs

Formulations of morphine sulfate and hydromorphone hydrochloride have been made using impregnation of these analgesic drugs into water-soluble polymer gels that may be administered by the oral route, IV infusion, or SC implantation (Lesser et al., 1996). This approach is also applied to delivery of antibiotics such as rifampicin for the treatment of tuberculosis, because this infectious disease requires long courses of therapy, and medication compliance is absolutely necessary to prevent the development of multidrug-resistant strains of the organism (Quenelle et al., 2004; Zahoor et al., 2005). Morphine sulfate embedded in chitosan gel, when injected subcutaneously in dogs, has a pharmacokinetic profile consistent with clinical administration of the drug every 12–24 hours. Some stiffness is associated with the injection of the preparation between the shoulder blades; however, this is resolved spontaneously by 48 hours postinjection (Tasker et al., 1997). Some drug formulations in polymerized gels have much longer kinetics (up to 4 weeks for rabbits *in vivo* for a hydromorphone preparation) than either oral or parenteral formulations of the same drugs (Lesser et al., 1996). Extremely long release kinetics is achieved at the cost of lower peak drug concentrations in peripheral blood than with other methods of administration. Such formulations may be optimal for treating chronic pain, such as that from arthritis or cancer, instead of acute postoperative pain management where release of the drug optimally occurs over a period of hours to days, and where peak blood drug levels decline 48–72 hours postoperatively. Polymer gels would also require minor surgery to periodically replace the gel for animals undergoing treatment of pain associated with long-term chronic conditions such as osteoarthritis.

B. Long-Acting Oral or Transdermal Formulations of Opioid Drugs

Oral opioid formulations, both short-acting and long-acting forms, are the mainstay of pain medication for humans. Codeine, which is used either alone or in combination with acetaminophen or other NSAIDs, is used to treat mild to moderate pain, generally associated with acute procedures such as dental extractions. Short-acting opioids with greater analgesic efficacy, such as morphine sulfate, hydromorphone, or oxycodone, are used to treat acute and chronic, moderate-to-severe pain, or to treat “breakthrough” pain in humans; and chronic pain is managed with extended-release opioids. The dose of extended-release opioids should be carefully titrated to match the severity of the pain, and clinicians should be aware that it might take some time for the effects of dose changes to be

seen (Gourlay, 1998). There is essentially no data on the clinical administration of any of these agents for pain management in laboratory animal species. Some long-acting forms of morphine sulfate have been available in the United States for many years. The forms marketed as MS-Contin® (Perdue Frederick, Stamford, CT) (Fig. 28-1) and Oramorph (Roxane Pharmaceuticals, Columbus, OH) must be swallowed whole without chewing or breaking (Gourlay, 1998). These formulations would be more practical for larger laboratory animal species such as dogs and, perhaps, pigs, where the pill could be either manually placed in the back of the throat or delivered there with a mechanical device. If the pills are damaged before reaching the stomach, there is a potential for overdose requiring treatment with reversal agents such as naloxone. Reduced therapeutic efficacy induced by a significant first-pass effect is a problem in dogs that have been administered oral opioids, including extended release preparations. MS-Contin does not achieve therapeutic blood levels in dogs when it is administered every 12 hours. Blood concentrations can be improved by dosing every 8 hours, but more frequent dosing obviates one of the benefits of using extended-release medications (Dohoo, 1997; Dohoo and Tasker, 1997). It may also be possible to compensate for the first-pass effect by increasing the dose of extended-release morphine formulations in dogs. It is unknown whether a first-pass effect could affect oral administration of extended-release morphine sulfate formulations in other laboratory animal species. An oral extended-release formulation of oxycodone, marketed as



Fig. 28-1 MS-Contin tablets, morphine sulfate controlled-release. These tablets are meant to be swallowed whole, but can be dosed once to twice a day. Chewing or splitting the tablets can result in unintentional overdose. Used with permission of Perdue Frederick, Stamford, CT.

OxyContin® (Perdue Frederick, Stamford, CT), could also be used for treating mild-to-moderate pain in laboratory animals. OxyContin also needs to be swallowed whole to avoid overdose. OxyContin has recently emerged as a significant diversion risk, and this may limit the use of this formulation.

Kapanol® (GlaxoSmithKline, Australia) is a long-acting granular formulation of morphine sulfate developed for oral administration every 12–24 hours in humans. The Kapanol granules can be swallowed in a single dose as a gelatin capsule, or the granules may be dispersed in liquid or semisolid food material such as fruit juice or yogurt (Egger et al., 1998; Gourlay, 1998). A dispersible granular formulation of a long-acting opioid medication could potentially be administered to rodents by gavage or in small amounts of highly palatable soft foods such as peanut butter or Transgenic Dough Diet (Bioserv Inc., Frenchtown, NJ). Kapanol has also been shown to be effective for treating pain when administered intrarectally in patients who are unable to swallow (Gourlay, 1998). Unfortunately, Kapanol is not marketed commercially in the United States. Two other granular formulations of extended-release morphine sulfate have recently been approved for use in the United States (Broomhead et al., 1997; Caldwell, 2004; Caldwell et al., 2002). Avinza® (Ligand Pharmaceuticals, San Diego, CA) (Fig. 28-2) is a novel morphine formulation that contains both immediate-release granules and extended-release granules. When extended-release granules in Avinza come into contact with gastrointestinal fluid, they swell and release morphine into the gastrointestinal tract (Caldwell, 2004; Caldwell et al., 2002). Kadian® (Alpharma Inc., Fort Lee, NJ) is an extended-release morphine sulfate preparation that is similar to Kapanol in formulation and has a similar pharmacokinetic profile in humans (Broomhead et al., 1997).



Fig. 28-2 Avinza capsule, morphine sulfate controlled-release. Avinza capsules can be swallowed whole or the capsule can be pulled apart and the granules disbursed in a small volume of highly palatable food or juice. The granules could potentially be administered by gavage or placed in soft glycerin and administered intrarectally to rodents.

Fentanyl is a synthetic, short-acting, and highly lipophilic opioid that has the potency approximately 80 times that of morphine sulfate (Jaffe and Martin, 1985). Because the drug is highly lipophilic, fentanyl may be administered transdermally (Jeal and Benfield, 1997) (Duragesic®, Janssen L.P., Titusville, NJ). A transdermal patch formulation that lasts up to 72 hours is available for use in humans, and fentanyl patches have been used successfully to treat postoperative pain in larger species of laboratory animals such as dogs and pigs. Broader use of the patch is hampered by several problems. Differences in skin thickness between humans and laboratory animals make onset of drug absorption variable and species dependent. In laboratory animals (e.g., dogs), the fentanyl patch must be placed 24 hours prior to the procedure for effective blood levels to be present at the time that analgesia is required. Dog studies have shown that there is a wide individual variation in the amount of drug absorbed (Kyles, 1996; Kyles et al., 1996), so analgesic needs are not always met when a fentanyl patch has been placed, or higher blood levels than are desired may occur with the attendant side effects of sedation and respiratory depression (Egger et al., 1998; Kyles, 1996; Kyles et al., 1996; Mills et al., 2004).

C. Analgesic Drugs Loaded into Pellets or Osmotic Pumps

Osmotic pumps (Alzet Corporation, Cupertino, CA) (Fig. 28-3A–C) and commercially prepared time-release pellets (Innovative Research Products Inc., Sarasota, FL; NIDA, Bethesda, MD) are commonly used to deliver test compounds in rodents. This strategy is not often used in clinical practice for pain control in laboratory animals and, therefore, very little is known about their use in the clinical setting. There is extensive literature on the use of Alzet pumps to deliver opioid compounds to rats and mice to achieve research objectives, and this literature could be extrapolated for clinical use (Behm, 1985; Behm et al., 1985; Martucci et al., 2004; Schmidt et al., 1985). Oxymorphone delivered via an intraperitoneal osmotic pump has been shown to be effective in managing postoperative pain in rats after intestinal resection surgery (Gillingham, 2001; Gillingham et al., 2001). Placement of the pumps was facilitated by the open abdomen required for the surgical procedure. If the animal was not euthanized at the end of the pump's delivery period, that pump would have to be removed and a new one implanted.

Time-release pellets are available from commercial sources for use with compounds that are not controlled substances (Innovative Research Products Inc., Sarasota, FL), or containing morphine from NIDA (El-Hage et al., 2006; Feng et al., 2006; Freier and Fuchs, 1993; Fuchs and Pruett, 1993; Latham et al., 2003). Use of controlled-release pellets has not been described for treating postoperative or chronic pain in laboratory animals, but the experimental literature could be used as a guide for clinical trials. Osmotic pumps, prefabricated

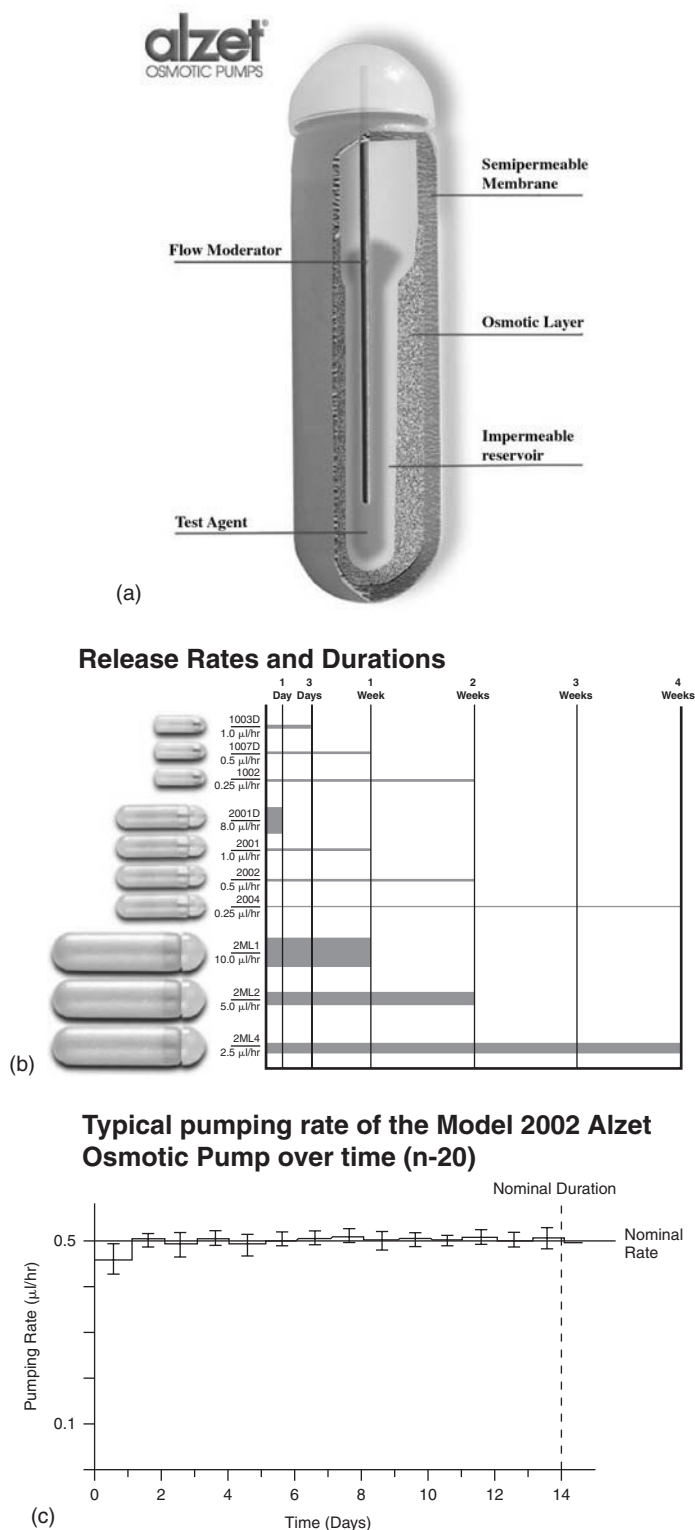

Fig. 28-3 (A) Internal diagram of an Alzet[®] osmotic pump. The device is loaded under aseptic conditions. A large body of experimental literature exists on the use of Alzet pumps loaded with opioid analgesic drugs. Used with permission of Alzet Corporation, Cupertino, CA. (B) Alzet osmotic pumps come in a variety of sizes and release rates. (C) Alzet osmotic pumps deliver essentially zero-order kinetics for the release life of the pump.

time-release pellets, and other extended-release preparations are expensive compared to conventional parenteral solutions of opioid analgesic drugs (Table 28-2). However, if the personnel time required for appropriate administration of an opioid drug such as oxymorphone is factored into the cost of experiment, the use of these delivery devices would become more acceptable to investigators.

D. Liposomal Formulations of Analgesic Drugs

Many of the delivery methods or devices previously mentioned suffer from a paucity of data with respect to their use in laboratory animals. They also suffer from a lack of commercially available dosage forms or formulations suitable for rodents. There is one commercially available liposomal formulation of morphine sulfate (DepoDur[®], SkyePharma Inc., San Diego, CA) (Fig. 28-4A–C) for which there is at least some data in rodent species (Kim et al., 1993, 1996; Yaksh et al., 1999, 2000). Administration of a single SC dose of liposomal formulation of morphine sulfate equivalent to DepoDur (2.8 mg/kg) will prevent the development of neuropathic pain in rats caused by sciatic nerve ligation. Pharmacokinetic studies on this liposomal morphine sulfate formulation indicate that the preparation lasts at least 48–72 hours *in vivo* (Smith et al., 2003). A slightly different liposomal formulation of morphine sulfate will produce therapeutic serum concentrations of drug for 5–6 days in mice after SC administration (Kim et al., 1993). The principal disadvantage of the DepoDur product is the high cost. It is currently marketed at approximately \$1,000 for five 10 mg ampoules; it would cost \$450 to inject ten 300 g rats at a dose of 3 mg/kg. If the ampoules are purchased individually, the price drops to approximately \$180 for all the rats in the experiment (Table 28-2). Work in our laboratory has shown that liposomal formulations of oxymorphone and hydromorphone have pharmacokinetic profiles in rats, which suggests the drug will remain in serum for 48–72 hours after administration when egg phosphatidylcholine (PC) is used as a lipid shell (Smith et al., 2003). Additional studies using liposomes made with dipalmitoyl phosphatidylcholine (DPPC) and cholesterol in the lipid shell suggest that drug release may be extended to 96 hours (Krugner-Higby, unpublished data). Pharmacokinetic studies using liposomal oxymorphone made with egg PC in dogs indicate that therapeutic concentrations are present in serum for up to 48 hours after SC administration (Smith et al., 2004). Liposomal formulations of ketamine hydrochloride and lidocaine hydrochloride have been evaluated for preliminary pharmacokinetics in rats after SC administration. The best formulation of ketamine hydrochloride using egg PC and cholesterol is present in serum for up to 48–72 hours; the DPPC formulation of lidocaine is present in serum for up to 96 hours. Studies are planned to test these drugs in models of neuropathic and somatic pain (Krugner-Higby, unpublished data). Additionally, changes in the formulation of the liposomes containing these drugs, such

TABLE 28-2

COMPARISON OF DIFFERENT DELIVERY SYSTEMS USED TO PROVIDE MORPHINE SULFATE POSTOPERATIVE ANALGESIA TO 10 LABORATORY RATS FOR 3 DAYS

Product	Approximate duration of effective analgesia	Route of administration	Approximate dosage	Approximate cost per ten 300 g adult rats
Granular extended-release morphine (Kadian)	12–24 hours	Oral gavage, intrarectal	30 mg/day, divided into 15 mg q12h	Thirty 30 mg capsules, of approximately \$100
Modified granular extended-release morphine (Avinza)	12–24 hours	Oral gavage, intrarectal	30 mg/day, divided into 15 mg q12h	Thirty 30 mg capsules, of approximately \$100
Osmotic pump (Alzet)	3–7 days	Subcutaneous implant	1 mg/kg/day	Three-day pump: \$170; 7-day pump: \$200; Sigma morphine: \$27.20
Parenteral liposomal morphine (DepoDur)	48–72 hours	Subcutaneous injection	2.5–3 mg/kg	Individual ampoules: \$180

as the use of pH gradients for drug loading or the use of sphingomyelin in place of PC, may alter the pharmacokinetics of the liposomal preparation such that the preparations persist for weeks to months *in vivo* and could be used for chronic, low-intensity pain such as that produced by osteoarthritis (Allen and Cullis, 2004; Waterhouse et al., 2005; Zhigaltsev et al., 2005).

In addition to preliminary pharmacokinetic work, liposomal preparations of oxymorphone and hydromorphone have been shown clinically to provide analgesia in laboratory animals. Liposomal oxymorphone and hydromorphone administered subcutaneously at equipotent dosages to the standard drug (1.2 and 4.0 mg/kg, respectively) prevent the development of neuropathic pain in rats in the sciatic ligation model (Smith et al., 2003, 2006). A single dose of liposomal oxymorphone has been shown to treat postoperative visceral pain associated with intestinal resection in rats as effectively as q4h or q8h SC injections of oxymorphone (Krugner-Higby et al., 2003). Liposomal oxymorphone has been shown to provide superior analgesia compared to buprenorphine in mice after splenectomy (Clark et al., 2004). These formulations are not yet commercially available, but they are actively under development.

Liposomal formulations of fentanyl have been developed for inhalant administration. They merit only a brief mention because this route of administration would not be practical for most laboratory animal species (Hung et al., 1995).

E. Topical Delivery of NSAIDs and Other Anti-Inflammatory Medications

Effective delivery of NSAIDs and other anti-inflammatory compounds without the undesirable side effects seen with systemic administration (Dial et al., 2005; Papich, 1997) has long been a goal in human and veterinary medicine. Aspercreme[®] (topical aspirin) has been marketed over the counter for human use, and dimethyl sulfoxide (DMSO) has been marketed for veterinary use for many years. This method of delivery has been

plagued by poor efficacy in the case of Aspercreme and by unacceptable side effects ranging from rash at the site of application to a garlic-like flavor in mouth of human patients in the case of DMSO (Preston, 2006; Santos et al., 2003). More effective NSAIDs, such as ketorolac, ketoprofen, and diclofenac, and better topical delivery methodologies have made this route of administration more practical and effective (Niethard et al., 2005; Toker et al., 2006), although meta-analysis of the available published studies has not always upheld the use of even the newer topical NSAIDs (Lin et al., 2004; Mason et al., 2004a, 2004b). Some topical NSAIDs have been found to have undesirable side effects. Topical ketoprofen has a propensity for producing allergic and photosensitizing reactions (Diaz et al., 2006). Most topical NSAID preparations are used in human medicine for arthritis and other rheumatic conditions (Niethard et al., 2005), or for the treatment of pain associated with athletic injuries (White, 2006).

Recently, two different calcineurin inhibitors have been approved for use in the topical treatment of atopic dermatitis (AD) as an alternative to topical steroids: pimecrolimus (Elidel[®], Novartis Pharma AG, Basel, Switzerland) and tacrolimus (Protopic[®], Astellas Pharma, Deerfield, IL) (Sunderkotter et al., 2006). These drugs inhibit IL-2-dependent T-cell activation (Krummen et al., 2006). They have minimal systemic absorption, excellent efficacy against the pruritis associated with AD, and few side effects. Most of the literature pertaining to these preparations is focused on the use of these preparations for pain and/or pruritis associated with AD (Kaufmann et al., 2006; Lakhanpaul et al., 2006; Lubbe et al., 2006; Paul et al., 2006; Sunderkotter et al., 2006). Other uses for this novel class of compounds include treatment of seborrheic dermatitis or granulomatous rosacea (Cunha, 2006; Cunha and Rossi, 2006). Laboratory animal professionals are usually called upon to treat acute postoperative pain rather than chronic inflammatory conditions. However, some of the discomfort, pain, and/or pruritis associated with surgical skin wounds may be amenable to treatment with these compounds (Clark et al., 2006; Malmberg et al., 1997; Santos et al., 2003).

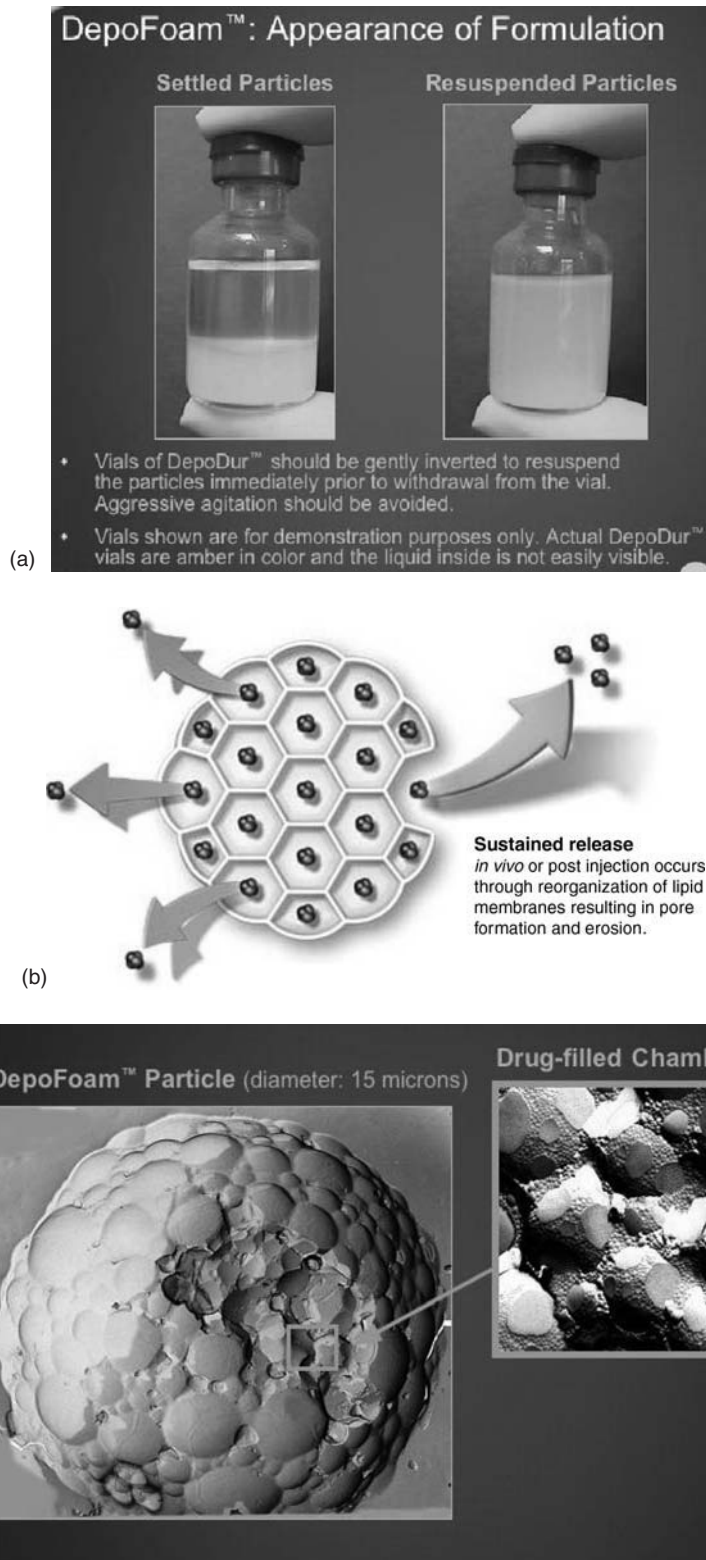

Fig. 28-4 (A) DepoDur is a suspension of liposomal morphine sulfate. The suspension must be gently mixed before it is administered. Liposomal products, including liposomal opioids, should be withdrawn from the bottle with a large-bore needle (18 gauge or larger) and then administered slowly using a small-bore needle (23–25 gauge). Used with permission of SkyePharma Inc., San Diego, CA. (B) A sketch of a multilamellar liposome. This type of liposome makes up the suspension of DepoDur. The drug trapped within the membrane-bound vesicles is released as the membranes break down. (C) A scanning electron photomicrograph of a multilamellar liposome. Morphine sulfate is released as the small vesicles break down.

Two preparations of liposomal topical anesthetics have been tested in companion and laboratory animals (Erkert et al., 2005; Flecknell et al., 1990; Gibbon et al., 2003). EMLA cream is a eutectic mixture of 2.5% liposomal lidocaine and 2.5% prilocaine (EMLA cream, AstraZeneca LP, Wilmington, DE). A preparation of 4% of lidocaine is also available (Fransson et al., 2002). Both products may be used to produce a small area of skin analgesia for minor procedures such as venipuncture and jugular catheter placement. EMLA cream has been used to facilitate venipuncture in laboratory animals, including dogs, cats, and rabbits. But it will not work on rattails (Flecknell et al., 1990). The chief disadvantage of EMLA cream is that it requires the placement of an occlusive dressing and further requires 60–90 minutes for full efficacy (Erkert et al., 2005; Flecknell et al., 1990; Gibbon et al., 2003). The 4% lidocaine preparation does not require application of an occlusive dressing, and efficacy can be achieved after 20 minutes (Fransson et al., 2002).

F. Anesthetic Catheters Delivering Continuous Infusions of Local Anesthetics

Special catheters, called “soaker catheters,” capable of delivering a continuous infusion of analgesic drug into a surgical site, have recently found use in human medicine. The use of a continuous rate infusion catheter has been shown to be superior to epidural opioid drug alone in treating pain associated with thoracotomy in humans (Wheatley et al., 2005). This type of device, while impractical for small rodents, could find use in treating postsurgical pain in large animals such as dogs, pigs, or sheep.

III. CONCLUSION

Medicine, both human and veterinary, has come a long way toward recognizing the value of analgesia in the return to function and quality of life for patients. In laboratory animal medicine, there are constraints placed on our ability to deliver the most potent opioid analgesics in an appropriate manner. The widespread use of buprenorphine hydrochloride by laboratory animal professionals has largely been a response to the short half-life of many pure agonist drugs such as morphine sulfate, oxymorphone, and hydromorphone. The use of buprenorphine has been a good beginning, but the limitations of the drug should encourage additional research in a number of directions, including new methods of delivery of existing analgesic drugs, and the development of new analgesics. We hope this chapter will stimulate additional research in the field of animal pain control, especially for procedures that cause moderate-to-severe pain in small rodents, which are increasingly used as surgical and disease models.

REFERENCES

- Allen, T.M., and Cullis, P.R. (2004). Drug delivery systems: Entering the mainstream. *Science* **303**, 1818–1822.
- Behm, M.C., Stout-Caputi, M.V., Mahalik, M.P., and Gautiere, R.F. (1985). Evaluation of the teratogenic potential of hydromorphone administered via a miniature implantable pump in mice. *Res. Commun. Subst. Abuse* **6**, 165–177.
- Broomhead, A., Kerr, R., Tester, W., O'Meara, P., Maccarrone, C., Bowles, R., and Hodsman, P. (1997). Comparison of a once-a-day sustained-release morphine formulation with standard oral morphine treatment for cancer pain. *J. Pain Symptom Manage.* **14**, 63–73.
- Caldwell, J.R. (2004). Avinza: 24-h sustained-release oral morphine therapy. *Expert Opin. Pharmacother.* **5**, 469–472.
- Caldwell, J.R., Rapoport, R.J., Davis, J.C., Offenber, H.L., Marker, H.W., Roth, S.H., Yuan, W., Eliot, L., Babul, N., and Lynch, P.M. (2002). Efficacy and safety of a once-daily morphine formulation in chronic, moderate-to-severe osteoarthritis pain: Results from a randomized, placebo-controlled, double-blind trial and an open-label extension trial. *J. Pain Symptom Manage.* **23**, 278–291.
- Clark, J.A., Jr., Myers, P.H., Goelz, M.F., Thigpen, J.E., and Forsythe, D.B. (1997). Pica behavior associated with buprenorphine administration in the rat. *Lab. Anim. Sci.* **47**, 300–303.
- Clark, J.D., Qiao, Y., Li, X., Shi, X., Angst, M.S., and Yeomans, D.C. (2006). Blockade of the complement C5a receptor reduces incisional allodynia, edema, and cytokine expression. *Anesthesiology* **104**, 1274–1282.
- Clark, M.D., Krugner-Higby, L., Smith, L.J., Heath, T.D., Clark, K.L., and Olson, D. (2004). Evaluation of liposome-encapsulated oxymorphone hydrochloride in mice after splenectomy. *Comp. Med.* **54**, 558–563.
- Cunha, P.R. (2006). Pimecrolimus cream 1% is effective in seborrheic dermatitis refractory to treatment with topical corticosteroids. *Acta Derm. Venereol.* **86**, 69–70.
- Cunha, P.R., and Rossi, A.B. (2006). Pimecrolimus cream 1% is effective in a case of granulomatous rosacea. *Acta Derm. Venereol.* **86**, 71–72.
- Dial, E.J., Dohrman, A.J., Romero, J.J., and Lichtenberger, L.M. (2005). Recombinant human lactoferrin prevents NSAID-induced intestinal bleeding in rodents. *J. Pharm. Pharmacol.* **57**, 93–99.
- Diaz, R.L., Gardezabal, J., Manrique, P., Raton, J.A., Urrutia, I., Rodriguez-Sasiain, J.M., and Aguirre, C. (2006). Greater allergenicity of topical ketoprofen in contact dermatitis confirmed by use. *Contact Dermat.* **54**, 239–243.
- Dohoo, S. (1997). Steady-state pharmacokinetics of oral sustained release morphine sulphate in dogs. *J. Vet. Pharmacol. Ther.* **20**, 129–133.
- Dohoo, S.E., and Tasker, R.A. (1997). Pharmacokinetics of oral morphine sulfate in dogs: A comparison of sustained release and conventional formulations. *Can. J. Vet. Res.* **61**, 251–255.
- Egger, C.M., Duke, T., Archer, J., and Cribb, P.H. (1998). Comparison of plasma fentanyl concentrations by using three transdermal fentanyl patch sizes in dogs. *Vet. Surg.* **27**, 159–166.
- El-Hage, N., Wu, G., Wang, J., Ambati, J., Knapp, P.E., Reed, J.L., Bruce-Keller, A.J., and Hauser, K.F. (2006). HIV-1 Tat and opiate-induced changes in astrocytes promote chemotaxis of microglia through the expression of MCP-1 and alternative chemokines. *Glia* **53**, 132–146.
- Erkert, R.S., Macallister, C.G., Campbell, G., Payton, M.E., Shawley, R., and Clarke, C.R. (2005). Comparison of topical lidocaine/prilocaine anesthetic cream and local infiltration of 2% lidocaine for episiotomy in mares. *J. Vet. Pharmacol. Ther.* **28**, 299–304.
- Feng, P., Rahim, R.T., Cowan, A., Liu-Chen, L.Y., Peng, X., Gaughan, J., Meissler, J.J., Jr., Adler, M.W., and Eisenstein, T.K. (2006). Effects of mu, kappa or delta opioids administered by pellet or pump on oral *Salmonella* infection and gastrointestinal transit. *Eur. J. Pharmacol.* **534**, 250–257.
- Flecknell, P.A., Liles, J.H., and Williamson, H.A. (1990). The use of lignocaine–prilocaine local anaesthetic cream for pain-free venepuncture in laboratory animals. *Lab. Anim.* **24**, 142–146.

- Fransson, B.A., Peck, K.E., Smith, J.K., Anthony, J.A., and Mealey, K.L. (2002). Transdermal absorption of a liposome-encapsulated formulation of lidocaine following topical administration in cats. *Am. J. Vet. Res.* **63**, 1309–1312.
- Freier, D.O., and Fuchs, B.A. (1993). Morphine-induced alterations in thymocyte subpopulations of B6C3F1 mice. *J. Pharmacol. Exp. Ther.* **265**, 81–88.
- Fuchs, B.A., and Pruett, S.B. (1993). Morphine induces apoptosis in murine thymocytes in vivo but not in vitro: Involvement of both opiate and glucocorticoid receptors. *J. Pharmacol. Exp. Ther.* **266**, 417–423.
- Gibbon, K.J., Cyborski, J.M., Guzinski, M.V., Viviano, K.R., and Trepanier, L.A. (2003). Evaluation of adverse effects of EMLA (lidocaine/prilocaine) cream for the placement of jugular catheters in healthy cats. *J. Vet. Pharmacol. Ther.* **26**, 439–441.
- Gillingham, M.B., Clark, M.D., Dahly, E.M., Krugner-Higby, L.A., and Ney, D.M. (2001). A comparison of two opioid analgesics for relief of visceral pain induced by intestinal resection in rats. *Contemp. Top. Lab. Anim. Sci.* **40**, 21–26.
- Gourlay, G.K. (1998). Sustained relief of chronic pain. Pharmacokinetics of sustained release morphine. *Clin. Pharmacokinet.* **35**, 173–190.
- Hawk, C., Leary, S.L., and Morris, T.M. (2005). "Formulary for Laboratory Animals." 3rd ed., p 19. Iowa State University Press, Ames, IA.
- Hung, O.R., Whynot, S.C., Varvel, J.R., Shafer, S.L., and Mezei, M. (1995). Pharmacokinetics of inhaled liposome-encapsulated fentanyl. *Anesthesiology* **83**, 277–284.
- Jaffe, J.H., and Martin, W.R. (1985). Opioid analgesics and antagonists. In "Goodman and Gilman's the Pharmacological Basis of Therapeutics." (A.G. Gilman, L.S. Goodman, T.W. Rall, and F. Murad, eds.), pp 491–531. Macmillan Publishing Company, New York.
- Jeal, W., and Benfield, P. (1997). Transdermal fentanyl: A review of its pharmacologic properties and therapeutic efficacy in pain control. *Drugs* **53**, 109–138.
- Kaufmann, R., Bieber, T., Helgesen, A.L., Andersen, B.L., Luger, T., Poulin, Y., Al-Hafidh, J., and Paul, C. (2006). Onset of pruritus relief with pimecrolimus cream 1% in adult patients with atopic dermatitis: A randomized trial. *Allergy* **61**, 375–381.
- Kim, T., Kim, J., and Kim, S. (1993). Extended-release formulation of morphine for subcutaneous administration. *Cancer Chemother. Pharmacol.* **33**, 187–190.
- Kim, T., Murdande, S., Gruber, A., and Kim, S. (1996). Sustained release morphine for epidural analgesia in rats. *Anesthesiology* **85**, 1–15.
- Krugner-Higby, L., Smith, L., Clark, M., Heath, T.D., Dahly, E., Schiffman, B., Hubbard-VanStelle, S., Ney, D., and Wendland, A. (2003). Liposome-encapsulated oxymorphone hydrochloride provides prolonged relief of postsurgical visceral pain in rats. *Comp. Med.* **53**, 270–279.
- Krummen, M.B., Varga, G., Steinert, M., Stuetz, A., Luger, T.A., and Grabbe, S. (2006). Effect of pimecrolimus vs. corticosteroids on murine bone marrow-derived dendritic cell differentiation, maturation and function. *Exp. Dermatol.* **15**, 43–50.
- Kyles, A.E., Papich, M., and Hardie, E.M. (1996). Disposition of transdermally administered fentanyl in dogs. *Am. J. Vet. Res.* **57**, 715–719.
- Latham, K.A., Zamora, A., Drought, H., Subramanian, S., Matejuk, A., Offner, H., and Rosloniec, E.F. (2003). Estradiol treatment redirects the isotype of the autoantibody response and prevents the development of autoimmune arthritis. *J. Immunol.* **171**, 5820–5827.
- Lakhanpaul, M., Davies, T., Allen, B.R., and Schneider, D. (2006). Low systemic exposure in infants with atopic dermatitis in a 1-year pharmacokinetic study with pimecrolimus cream 1%. *Exp. Dermatol.* **15**, 138–141.
- Lesser, G.J., Grossman, S.A., Leong, K.W., Lo, H., and Eller, S. (1996). In vitro and in vivo studies of subcutaneous hydromorphone implants designed for the treatment of cancer pain. *Pain* **65**, 265–272.
- Lin, J., Zhang, W., Jones, A., and Doherty, M. (2004). Efficacy of topical non-steroidal anti-inflammatory drugs in the treatment of osteoarthritis: Meta-analysis of randomised controlled trials. *BMJ* **329**, 324.
- Lubbe, J., Friedlander, S.F., Cribier, B., Morren, M.A., Garcia-Diez, A., Gelmetti, C., Hofmann, H., Houwing, R.H., Kownacki, S., Langley, R.G., Virtanen, M., Wolff, K., Wisseh, S., McGeown, C., Abrams, B., and Schneider, D. (2006). Safety, efficacy, and dosage of 1% pimecrolimus cream for the treatment of atopic dermatitis in daily practice. *Am. J. Clin. Dermatol.* **7**, 121–131.
- Malmberg, A.B., Brandon, E.P., Idzerda, R.L., Liu, H., McKnight, G.S., and Basbaum, A.I. (1997). Diminished inflammation and nociceptive pain with preservation of neuropathic pain in mice with a targeted mutation of the type I regulatory subunit of cAMP-dependent protein kinase. *J. Neurosci.* **17**, 7462–7470.
- Martucci, C., Panerai, A.E., and Sacerdote, P. (2004). Chronic fentanyl or buprenorphine infusion in the mouse: Similar analgesic profile but different effects on immune responses. *Pain* **110**, 385–392.
- Mason, L., Moore, R.A., Edwards, J.E., Derry, S., and McQuay, H.J. (2004a). Topical NSAIDs for acute pain: A meta-analysis. *BMC Fam. Pract.* **5**, 10.
- Mason, L., Moore, R.A., Edwards, J.E., Derry, S., and McQuay, H.J. (2004b). Topical NSAIDs for chronic musculoskeletal pain: Systematic review and meta-analysis. *BMC Musculoskelet. Disord.* **5**, 28.
- Mills, P.C., Magnusson, B.M., and Cross, S.E. (2004). Investigation of in vitro transdermal absorption of fentanyl from patches placed on skin samples obtained from various anatomic regions of dogs. *Am. J. Vet. Res.* **65**, 1697–1700.
- Niethard, F.U., Gold, M.S., Solomon, G.S., Liu, J.M., Unkauf, M., Albrecht, H.H., and Elkik, F. (2005). Efficacy of topical diclofenac diethylamine gel in osteoarthritis of the knee. *J. Rheumatol.* **32**, 2384–2392.
- Papich, M.G. (1997). Principles of analgesic drug therapy. *Semin. Vet. Med. Surg. Small Anim.* **12**, 80–93.
- Paul, C., Cork, M., Rossi, A.B., Papp, K.A., Barbier, N., and de Prost, Y. (2006). Safety and tolerability of 1% pimecrolimus cream among infants: Experience with 1133 patients treated for up to 2 years. *Pediatrics* **117**, e118–e128.
- Plumb, D.C. (1995). Oxymorphone. In "Veterinary Drug Handbook." (D.C. Plumb, ed.), 2nd ed., pp 455–458. Iowa State University Press, Ames, IA.
- Preston, I. (2006). Reflections on a career in communication research as used in investigating puffery and other internet advertising claims for deceptiveness. *Int. J. Adv. Media Commun.* **1**, 111–121.
- Quenelle, D., Winchester, G.A., Staas, J.K., Hoskins, D.E., Barrow, E.W., and Barrow, W.W. (2004). Sustained release characteristics of rifampin-loaded microsphere formulations in nonhuman primates. *Drug Deliv.* **11**, 239–246.
- Santos, N.C., Figueira-Coelho, J., Martins-Silva, J., and Saldanha, C. (2003). Multidisciplinary utilization of dimethyl sulfoxide: Pharmacological, cellular, and molecular aspects. *Biochem. Pharmacol.* **65**, 1035–1041.
- Schmidt, W.K., Tam, S.W., Shotzberger, G.S., Smith, D.H., Jr., Clark, R., and Vernier, V.G. (1985). Nalbuphine. *Drug Alcohol Depend.* **14**, 339–362.
- Smith, L.J., Krugner-Higby, L., Clark, M., Wendland, A., and Heath, T.D. (2003). A single dose of liposome-encapsulated oxymorphone or morphine provides long-term analgesia in an animal model of neuropathic pain. *Comp. Med.* **53**, 280–287.
- Smith, L.J., Krugner-Higby, L., Flaska, D., Joers, V., and Hutson, P. (2004). Pharmacokinetics and sedative effects of a novel slow-release formulation of oxymorphone in dogs. *J. Vet. Pharmacol. Ther.* **27**, 1–4.
- Smith, L.J., Valenzuela, J.R., Krugner-Higby, L.A., Brown, C., and Heath, T.D. (2006). A single dose of liposome-encapsulated hydromorphone provides extended analgesia in a rat model of neuropathic pain. *Comp. Med.* **56**, 487–492.
- Sunderkotter, C., Weiss, J.M., Bextermoller, R., Loffler, H., and Schneider, D. (2006). Post-marketing surveillance on treatment of 5,665 patients with atopic dermatitis using the calcineurin inhibitor pimecrolimus: Positive effects on major symptoms of atopic dermatitis and on quality of life. *J. Dtsch. Dermatol. Ges.* **4**, 301–306.
- Tasker, R.A., Ross, S.J., Dohoo, S.E., and Elson, C.M. (1997). Pharmacokinetics of an injectable sustained-release formulation of morphine for use in dogs. *J. Vet. Pharmacol. Ther.* **20**, 362–367.

- Thompson, A.C., Kristal, M.B., Sallaj, A., Acheson, A., Martin, L.B., and Martin, T. (2004). Analgesic efficacy of orally administered buprenorphine in rats: Methodologic considerations. *Comp. Med.* **54**, 293–300.
- Toker, M.I., Erdem, H., Erdogan, H., Arici, M.K., Topalkara, A., Arslan, O.S., and Pahsa, A. (2006). The effects of topical ketorolac and indomethacin on measles conjunctivitis: Randomized controlled trial. *Am. J. Ophthalmol.* **141**, 902–905.
- Waterhouse, D.N., Madden, T.D., Cullis, P.R., Bally, M.B., Mayer, L.D., and Webb, M.S. (2005). Preparation, characterization, and biological analysis of liposomal formulations of vincristine. *Methods Enzymol.* **391**, 40–57.
- Wheatley, G.H. III, Rosenbaum, D.H., Paul, M.C., Dine, A.P., Wait, M.A., Meyer, D.M., Jessen, M.E., Ring, W.S., and DiMaio, J.M. (2005). Improved pain management outcomes with continuous infusion of a local anesthetic after thoracotomy. *J. Thorac. Cardiovasc. Surg.* **130**, 464–468.
- White, R.L. (2006). Ketoprofen gel as an adjunct to physical therapist management of a child with sever disease. *Phys. Ther.* **86**, 424–433.
- Yaksh, T.L., Provencher, J.C., Rathbun, M.L., and Kohn, F.R. (1999). Pharmacokinetics and efficacy of epidurally delivered sustained-release encapsulated morphine in dogs. *Anesthesiology* **90**, 402–412.
- Yaksh, T.L., Provencher, J.C., Rathburn, M.L., Myers, R.R., Powell, H., Richter, P., and Kohn, F.R. (2000). Safety assessment of encapsulated morphine delivered epidurally in a sustained-release multivesicular liposome in dogs. *Drug. Deliv.* **7**, 27–36.
- Yu, S., Zhang, X., Peng, Y., Johnson, J., Mandrell, T., Shukla, A.J., and Laizure, S.C. (2006). Pharmacokinetics of buprenorphine after intravenous administration in the mouse. *J. Am. Assoc. Lab. Anim. Sci.* **45**, 12–16.
- Zahoor, A., Sharma, S., and Khuller, G.K. (2005). Inhalable alginate nanoparticles as antitubercular drug carriers against experimental tuberculosis. *Int. J. Antimicrob. Agents* **26**, 298–303.
- Zhigaltsev, I.V., Maurer, N., Akhong, Q.F., Leone, R., Leng, E., Wang, J., Semple, S.C., and Cullis, P.R. (2005). Liposome-encapsulated vincristine, vinblastine and vinorelbine: A comparative study of drug loading and retention. *J. Control. Release* **104**, 103–111.

Nonpharmacologic Pain Control

Sara Savage

I. Introduction	619
II. Preventative Strategies	620
A. Education	620
B. Refinement of Experimental Conditions	620
III. Nonpharmacologic Interventions	622
A. Thermal Techniques	622
B. Movement-Based and Manual Therapies	624
C. Electroanalgesia	625
D. Acupuncture	626
IV. Summary and Future Scope	627
References	627

I. INTRODUCTION

Minimization of pain is an ethical and scientific imperative of laboratory animal care (National Research Council, 1996). This philosophy most often leads to a plan to administer one or more doses or types of analgesic drugs (e.g., opioid or nonsteroidal anti-inflammatory drugs) to animals that are expected to experience pain in surgical and disease models. Attempts at managing pain by analgesic treatment are greatly limited. There is still a lack of evidence to support dosing information for many laboratory animal species, and there are significant concerns that certain drugs will confound the model under investigation. Also, despite use of “proven effective” analgesics, animals and humans may still experience significant unrelieved pain. This limitation of analgesic therapy has led to the increasing recognition of the role of nondrug methods of reducing painfulness of procedures and injury states in clinical human medicine. A ready example of this is the use of ice to reduce pain and swelling after

trauma. In situations where drugs could not be used because of study constraints, or are known to be ineffective, comfort measures should still be considered. Novel and sometimes simple nondrug strategies should be explored for their potential to reduce the noxiousness of experimental conditions. To the extent that they can be standardized, such strategies can serve as primary and/or adjunctive analgesia “methods.”

In fact, a variety of nondrug methods to manage pain are being investigated in human pediatric and adult medicine to the point where they are incorporated as “mainstream” modalities. Evidence for reduction of pain by use of some of these therapies exists in placebo-controlled studies in the human medical literature and also in some animal models. It remains to be seen whether this is generally true for clinical relief of pain in animals. At the very least, a thoughtful approach to minimizing the difficulties that animals might experience from their environment and handling may lead to a reduction in overall stress and pain.

The author's initial approach to nonpharmacologic pain control is to comprehensively assess the degree to which manipulations or conditions might cause pain (see Chapter 8 also). There is a notable tendency to consider only pain of limited duration and acute intensity, but it should be emphasized that animals in sick and chronic disease models and also those in which only sample collection or even euthanasia is performed also stand to benefit from prevention of painful or distressing stimuli. It is also useful to reflect that human medicine defines pain as "an unpleasant sensory *and emotional* experience, which is primarily associated with tissue damage or described in terms of such damage, or both" (International Association for the Study of Pain, IASP). While interpretation of the emotional state of the animal is still controversial, the IASP definition highlights the fact that pain and the perception of pain is affected by noxious sensory stimuli as well as by factors that lead to stress, fear, and anxiety. It would be easy to dismiss such a sensitive approach to management of husbandry and animal manipulation as tender-hearted anthropomorphism. But since evidence from both human and animal models suggests that pain and stress suppress immune function, reduce reproductive performance, alter normal behavior, and prolong surgical healing, among other effects, alteration of the intended model by those "side effects" of pain and stress should be something to take seriously and prevent if possible (Beilin et al., 2003; Charmandari et al., 2005; Kehlet, 2004; Marsland et al., 2002; McEwen, 2004; McGuire et al., 2006; Watkins and Maier, 2005).

This chapter outlines a potential approach to reducing noxious stimuli and reviews a variety of nonpharmacologic methods of potential benefit for the relief of pain. Samples of evidence for effectiveness of an intervention are given, although extrapolation from one species to another (including human trials and animal models) is still needed. As of now, there is a heavy reliance on observation and experience in clinical veterinary pain medicine, rather than on randomized controlled trials. Thus, scientific evidence for analgesic efficacy of veterinary nonpharmacological techniques is scarce. A number of nondrug techniques for pain relief require specialized training of equipment as well as procedural time, making these less practical. The practical relevance of a technique in terms of benefit and difficulty of implementation is noted for each technique. However, as nonpharmacological pain relief becomes more widely studied in both human and veterinary medicine, the laboratory animal practitioner may find new and useful techniques for maximizing the well-being of animals.

II. PREVENTATIVE STRATEGIES

A. Education

Critical to the implementation of any strategy is a partnership with the research and husbandry staff. In order to recognize the

need for additional measures, staff should receive training in basic principles of stress and pain reduction and species-specific recognition of pain and distress. If a new strategy is perceived to be difficult or time-consuming, and a need for improved care is not recognized, it will be difficult to implement it as staff may resent the extra effort. When investigators and staff can be given an appreciation for the beneficial impact of result or change, then they may be more willing to take the extra steps needed.

In the author's experience, scientists prefer to have scientific evidence to support any positive effects of nonpharmacologic interventions in their animal models and to subject them to a "cost-benefit" analysis prior to their use. A technique that makes animal *handlers* feel better (but not the animal) is not worthwhile to perform, especially if there is a concern that the intervention may alter research results. Because there may not be data to support the benefit of a technique, its implementation can be an experiment in itself, and so the assessment and documentation of results is required. This may necessitate development of more sophisticated scoring systems, and in some cases, pilot studies or increased numbers of control groups within studies, and more specific definition of research endpoints. Structured observations are more likely to reveal a beneficial effect than casual appraisal.

B. Refinement of Experimental Conditions

The initial step in successful management of animal pain is a detailed evaluation of the experimental and husbandry conditions in order to predict where interventions might ameliorate painful or distressing stimuli. What might seem like minor details (e.g., restraint) may have a significant difference to the animal experiencing pain. All aspects of the study, including acclimation, social, and environmental conditions, and methods used in research procedures, are worthy of consideration.

1. *Acclimation*

Acclimation of animals is understood to optimize homeostatic balance, and may decrease stress-related increases in physiologic parameters linked to the development of hyperalgesic and hypo-immune states. The duration of time for animals to acclimate may not be established for the parameter under investigation in the study of question. Average acclimation to decrease alterations in hematologic parameters sufficient for most studies is 5 days (National Research Council, 1996).

2. *Social Housing Conditions*

Social factors may greatly augment or detract from well-being. A change from singly to group housed, or vice versa, or altering social hierarchies by mixing animals mid-study may impose both a stress on animals and an unwanted experimental

variable. There is a robust literature on the impact of social conditions on animal biology dating back several decades. Social isolation can lead to immune suppression, and this is observed in numerous animal models, including pigs (Tuchscherer et al., 2004), sheep (Degabrielle and Fell, 2001), rats (Popovic et al., 2000), and macaques (Capitano, 1999). As a stressor, social isolation may favor a hyperalgesic state, or decrease the animal's response to analgesic drugs. Based on their work on morphine dependence and social stress, Broseta et al. (2005) suggest that isolated mice might show less responsiveness to morphine analgesia. Panksepp (1980) found that socially isolated young rats were more responsive to tail-shock-induced vocalizations, and that the analgesic response to morphine was greater in socially housed animals than in rats isolated for 3–4 days.

3. *Olfactory Stimuli*

Olfactory cues represent a form of animal communication that may not be familiar to nonveterinarians, and so their importance to animals can easily be overlooked. As males and females of many species scent-mark cage elements, keeping olfactory cues consistent with the pre-manipulation period might theoretically decrease stress. An example of such a measure is the moving of an already shredded nestlet or bedding from the pre-operative cage to the post-operative cage, making the cage smell familiar as well as helping an animal thermoregulate with less expenditure of energy. Exposure of prey species to scents of predators enhances fear and stress behavior (Takahashi et al., 2005). A logical assumption is that personnel and equipment (such as containers used to weigh animals, lab coats, gloves, etc) should be segregated by species to avoid stressing animals. Odors that humans may associate with cleanliness or find pleasant may represent a stress to animals. Thus, the use of scented deodorizers, detergents, and personal grooming items may be stressful to animals.

4. *Ambient Humidity, Light, or Temperature Levels*

The *Guide for the Care and Use of Laboratory Animals* (National Research Council, 1996) gives a wide range of acceptable humidity levels (from 30% to 70%) for housing laboratory animals; however, neuropathic pain behavior in rodents is differentially affected by humidity level (Vissers et al., 2003). Chesler et al. (2002) reported that ambient humidity affected latency response in a mouse thermal nociception model. Lighting conditions may be manipulated to help animals with vision disorders. For example, in the author's experience, neonatal C57BL/6 mice underwent laser ablation of retinal vessels at birth to induce disease in which the normally sealed eyelids are opened, with management of acute procedural pain by topical analgesics. As these animals grew, normal facility light levels appeared to be an aversive stimulus. Reduction of light intensity levels to below 2 lux by simply shrouding cages or by using cages of darkly colored plastics appears to permit the mice to exhibit

normal activity and feeding behavior. A logical extension of this is that animals kept in dim-light situations for any reason may find removal from their facility housing to highly lit laboratories distressing. Ambient temperature preferences for animals may vary with disease state or genotype, and increasing thermal support, or offering a gradient may provide comfort to sick animals. Measures to buffer temperature changes should be considered for vulnerable animals when they must be transported outdoors or when the laboratory temperature is very different from that of the housing facility. For sick or debilitated animals, ambient conditions may not only cause distress, but impact the success and repeatability of the model as well.

5. *Substrate*

Altering footing or deepening of bedding substrate may improve comfort; this is suggested, for example, when animals have fragile or injured skin, conditions that reduce pain tolerance thresholds (such as footpad injections) or for those that will be recumbent for any reason. The author's facility changes rodent bedding from a cob-type to softer loose alpha cellulose 2 days prior to the predicted development of rheumatoid arthritis in order to assist in the prevention of pressure sores. We also find it useful to provide footing with increased traction for models in which lameness develops after orthopedic surgery. For example, after cranial cruciate ligament transection, pigs benefit from removable nonslip decking placed under standard bedding.

6. *Environmental Enrichment*

Intended to improve well-being in animals by providing opportunity for chewing, hiding, or playing, the effects of enrichment measures should be monitored and at times reevaluated for their impact on animals. Some modifications might unexpectedly enhance stress. An example is that of mice habituated to shelters, and then outfitted with cranial implants that prohibit use of the shelter. In addition, some nesting materials may tangle in implants or adhere to wounds. Painful animals may have decreased ability to use manipulanda or exercise equipment commonly provided for enrichment. For species that display gnawing behavior, oral pain may preclude use of wood objects and softer objects such as paper or cardboard can be substituted. Food texture and location can be altered to help animals with difficulty in reaching feeders or chewing. The opportunity to exercise, dig, hide, or nest may be specifically precluded by study conditions and alternative enclosures or occupations may be devised that allow some heterogeneity of behavioral expression, arguably improving well-being.

7. *Handling and Perioperative Considerations*

Restraint and transportation may cause iatrogenic injury. Water sippers, feeders, or other potentially hazardous items may need to be removed or padded prior to anesthetic administration

or transport. Reducing forcible restraint by training animals to enter a chute or to present themselves for exam or injections, and other novel methods may be beneficial. In the author's experience, rats recovering from thoracotomy can be given drug injections subcutaneously through a butterfly catheter while inside the cage, without the need for lifting them and potentially exacerbating acute surgical pain. Slings, restraint devices, and surgical positioning that impose "nonphysiologic" positions on conscious or unconscious animals pose a significant risk for muscle, skin, or nerve injury. For anesthetized animals, the weight of a limb hanging off a table edge, positioning by means of ligatures around limbs, endotracheal tube cuffs, and ties can damage nerves or compromise blood flow to muscles and skin. "Noose" type restraints used to restrain limbs should be replaced with broad strapping/slings or tape to disperse pressure over a greater surface area. Forced limb abduction or open jaw positions held for hours at a time, even in anesthetized animals, can result in procedure-induced muscle strain and pain. Conscious animals restrained in positions that are not comfortable, or that must wear bandages or garments for any reason, may struggle and resist; and when physiologic monitoring is attempted, values may be altered, reflecting this discomfort. A halter left in place and pulled tightly may result in facial nerve injuries. There are countless reports in the human and veterinary literature of such types of iatrogenic injury, and although easily avoidable, conscientious effort is involved. If prolonged restraint is required, moving the animal or unaffected body parts frequently to redistribute blood supply and pressure points may assist in reducing injury. As observed in human patients, repositioning, peripheral limb massage, and passive range of motion exercises would be expected to improve comfort in any animal expected to be immobile for days or longer. Prevention of intraoperative hypothermia, or rewarming prior to anesthetic recovery, will decrease shivering to restore body temperature, and shivering is an acute noxious event.

Less invasive surgical or procedural techniques could be considered, such as percutaneous ultrasound-guided cannulation rather than surgical access to a portal vein. The availability of size-appropriate surgical devices, such as retraction systems, may reduce tissue trauma and facilitate exposure at the surgery site. Inexperienced personnel, whether performing surgery or simply restraining, may cause more tissue trauma and pain, and thus supervised practice and/or practice on cadavers should be the prerequisites.

III. NONPHARMACOLOGIC INTERVENTIONS

Nondrug treatments for pain primarily involve thermal therapies, movement-based and manual therapies, electrotherapy or electrostimulation, and acupuncture. Not covered in this chapter are the so-called energy medicine techniques, which can range from the use of light, magnetism, or sound therapy to

touch therapies, and homeopathy, as less scientific evidence is available to support their use. Nonpharmacologic or nondrug methods for treatment of pain predominantly (but not solely) address musculoskeletal (which might be nociceptive or neuropathic) pain conditions. Both acute and chronic pain may respond to nondrug techniques. The scope of potential nondrug methods in animals could be envisioned to parallel those methods utilized in humans, with exceptions.

Nondrug methods to treat pain may be used in conjunction with traditional analgesic drugs, may reduce the need for drugs, and in a few cases may be able to provide sufficient relief on their own, replacing drugs altogether. Some may produce analgesia specifically, and others may improve function or mood, thus improving comfort. It is commonly perceived that nondrug techniques are "safer" than drugs, but certainly there is some potential for harm caused by certain modalities. Time and cost factors also must be factored in when considering nondrug therapies for, for example, chronic pain, because some investment of time and effort may be needed. In addition, it may not be possible to offer some therapies without taking specialized training.

A. Thermal Techniques

1. Cryotherapy

An inexpensive, technically simple, and well-established approach to analgesia is the application of cold. The goal of cryotherapy is to reduce inflammatory response to injury, decrease bleeding, and provide analgesia. Cryotherapy is usually applied during the acute phase of injury, although it is also used for chronic muscle spasticity, and is used in rehabilitation medicine to remediate exercise-induced inflammatory responses in healing tissues (Heinrichs, 2004; Wright and Sluka, 2001).

There are a variety of physiologic mechanisms by which cryotherapy results in pain relief. Decreases in local tissue temperature have been cited to reduce cell metabolism and membrane permeability, slow nerve conduction velocity, decrease muscle spindle activity, cause sympathetic vasoconstriction, reduce edema, decrease blood flow, and decrease histamine release (Heinrichs, 2004; Linchitz and Sorell, 2000).

Cryotherapy is most often applied superficially, and works via heat transfer from the tissues to the cold modality applied to the body. Humans report that over a typical application period of 20 minutes, sensations produced range from mildly aversive to painful to numb. Limitations include the fact that some animals may not willingly accept cold therapy, or may be too small or not handleable. Habituating research animals with positive reinforcement to the sensations produced by cryotherapy prior to the production of painful stimuli is highly recommended. For example, the author found that pigs undergoing stifle surgery could be preconditioned to the sensation of ice applied over the stifle by two short training sessions during mealtimes. Application

of ice in the acute postoperative period was then easily accomplished with the use of food rewards. The author has also used cryotherapy for durations varying from 2 to 5 minutes in rodents and lagomorphs to good effect.

Various cryotherapy methods exist, ranging from topical application of ice packs, chemical gel cold packs, or "ice massage," to use of cold water baths and cold compression units. The choice of modality is governed by the degree of cooling required, the size of the area to be cooled, and the depth of penetration needed, as well as by species and facility constraints. Therapy is applied directly over or around the area of injury. Use of chemical gel packs or crushed ice permits molding around limbs and joints. A homemade slush pack can be made by mixing three parts water to one part rubbing alcohol, double bagging, and freezing until the proper consistency is achieved. An alcohol slush pack may be more efficacious than solid ice, because it transfers energy more efficiently to reduce heat at the targeted site (Heinrichs, 2004).

In larger species, cryotherapy is recommended for periods of at least 20–30 minutes to produce analgesia, which may be long lasting. The rate of temperature transfer and onset of analgesia can be increased by altering the modality used. Ice massage (basically rubbing the area with ice cubes or blocks) stimulates mechanoreceptors as well as cold receptors to augment the analgesic effect, and can result in numbing in as little as 5–10 minutes (Heinrichs, 2004). Cryotherapy as an adjunctive therapy can alter absorption or metabolism of locally injected agents, which may or may not be desired.

Cryotherapy can be appropriate for any amenable species, but care must be taken with the application of cold, particularly to smaller animals such as rodents. It is possible to induce hypothermia or tissue damage with the application of ice over body surfaces, and wetting of fur and skin enhances this effect. In neonatal or thin, debilitated animals this effect is further enhanced due to decreased concentrations of subcutaneous fat. Skin-surface blanching indicates that tissue damage (frostbite) is imminent; therefore, it is recommended that skin appearance be checked every few minutes. It is appropriate to decrease duration of exposure to ameliorate these risks with the decreasing size of patient or area of injury (Heinrichs, 2004).

Cryotherapy is specifically contraindicated for application over open wounds, in conditions of ischemia or vascular compromise, hypothermia, and in any animal that is sedated or otherwise unable to signal discomfort indicating impending tissue injury. Cryotherapy offers a technically easy and effective method of nondrug pain relief for acute injury or surgery in a laboratory animal setting, and might be adapted for very small mammals.

2. *Therapeutic Heat*

Both superficial and deep (via therapeutic ultrasound) heat modalities have been used to treat pain in humans and animals. Indicated in cases where acute inflammation has resolved, rather

than in acute injury, the therapeutic goal of heat application is to increase skin and joint temperatures and local blood flow, and to reduce joint stiffness and muscle spasm. Common uses are for muscle contracture, chronic inflammation, tendonitis, bursitis, sprain, scars, and trigger points (Wright and Sluka, 2001).

Heat is postulated to reduce pain by its effects on vasodilation with reduction of ischemic pain and removal of inflammatory mediators, enhanced metabolic activity, and decreases in Type II muscle spindle and gamma efferent fiber firing rates, which induces muscle relaxation (Heinrichs, 2004; Wright and Sluka, 2001). Increased perfusion of muscle may be an indirect result when muscle spasm is reduced (Heinrichs, 2004; Steiss and McCauley, 2004). Increases in body heat also slow peristalsis, decrease uterine contractions, and increase connective tissue extensibility and elasticity (Heinrichs, 2004; Linchitz and Sorell, 2000).

Superficial modalities usually heat tissues to a depth of 1–2 cm, and transfer energy by conduction or convection. Hot packs, hydrocollator (mud filled) packs, hydrotherapy baths, circulating warm water blankets, and warm air blankets can be used for superficial heat therapy. Inexpensive and reusable packs can be purchased commercially or made from materials such as gloves filled with water or socks filled with rice and heated briefly in a microwave (Heinrichs, 2004).

To alter blood flow significantly, tissue temperature needs to increase by a minimum of 5°C, depending upon site of application (Guyton, 1986). This is not always comfortable or practical in animals and will vary by species. When improperly administered, injury is likely. Necrosis of the epidermis in humans and pigs occurred after 35 minutes of increased skin temperatures at 47°C (Gregory, 2004). Thus, an aversive response to heat therapy may indicate impending tissue damage in an animal. If the person applying the heat source finds it too hot to hold, it should be considered too hot to apply to the animal. Especially when heated in a microwave, measurement and recording of temperature of sources such as heat packs or rice socks is prudent. Some guidelines for commercial products are available; for example, it is recommended that the temperature of hydrocollator packs be no more than 12°C above the animal's body temperature to prevent burns (Hourdebaigt, 2004). Typical protocols call for application of heat under 48°C for periods of 20 minutes or longer, several times every 24 hours. The author's experience is that in small laboratory animals, periods of as short as 5–10 minutes three times daily for musculoskeletal pain provide relief.

Heat is contraindicated in cases of active inflammation or infection, skin disease, local malignancy, overly sedated or insensitive patients (as excessive temperature needs to be detected by the patient), shock, hypotension, actively bleeding sites, and over the eyes. Heat lamps must be used only with extreme caution and monitoring. Proper distance from skin to heat source are critical to avoid burns, governed by the inverse square law, which states "for every twofold change in distance of application, there is a fourfold change in heating intensity"

(Linchitz and Sorell, 2000). Superficial heat therapy is a realistically achieved method of treating chronic pain in laboratory animals, depending on the situation.

3. *Deep Heating Therapy*

Therapeutic ultrasound involves application of acoustic vibration to transfer energy to tissues (lower-frequency sound penetrates deeper), generating heat in tissues up to a depth of 5 cm for short periods of time (generally less than 10 minutes). Heating muscles at a deeper level is preferable to superficial heating methods. The beam does not travel through air (a coupling agent, gel, or water is used), and is absorbed differentially by target tissues. Bone absorbs more sound than muscle, which in turn absorbs more sound than fat (Steiss and McCauley, 2004). The heating occurs (if done correctly) preferentially in deeper tissues and at tissue interfaces. In addition to increasing blood flow, therapeutic ultrasound is thought to produce analgesia through enhanced wound healing and increase in collagenase activity and collagen deposition, although other cellular mechanisms have been postulated (Abed et al., 2007). Commercial therapeutic ultrasound units, originally marketed for humans, are popular with canine and equine rehabilitation specialists. These units are relatively costly and require technical expertise for use and, as they typically employ 1 or 3.3 MHz transducers of 2–5 cm in diameter, their usefulness in smaller species would be limited. Frequency, intensity, cycles, duration, etc., are varied by patient and condition. There are few clinical studies of therapeutic ultrasound in animals, but animal model data is available. It appears that the ability of therapeutic ultrasound to produce analgesia is variable, and conflicting results have been reported (Abed et al., 2007). Specific guidelines for frequency, intensity, and duration of application can be extrapolated from human guidelines. Other limitations of therapeutic ultrasound in animals include that light sedation may be necessary, because heating of deep tissues and the light pressure of the transducer over sensitive skin can cause discomfort. Fur absorbs sound and it is recommended that clipping precede therapy (Steiss and Adamas, 1999). Contraindications include those for superficial heat, as well as the presence of implants, pacemakers, over a gravid uterus, testes, over bony prominences, where circulation is impaired, over the spinal cord after laminectomy, and over fracture sites (Steiss and McCauley, 2004).

B. **Movement-Based and Manual Therapies**

1. *Physical Therapy*

Physical therapy is a rehabilitative modality, and arguably produces most if its analgesic effects through decreases in healing time and promotion of mobility. Movement, whether passive or active, is the cornerstone of physical therapy. Therapies include passive and assisted range of motion, aquatic

therapy, muscle strengthening, gait training, balance training, coordination training, and motor control exercises, as well as aerobic conditioning. Exercise is intended to strengthen muscles, improve flexibility, reinstate normal motor patterns, and increase endurance (Linchitz and Sorell, 2000).

Laboratory animal models have been used in the development of specific exercises, recommended frequencies, and durations for rehabilitation programs for clinical management of dysfunction and pain. For example, in a study of immobilized rat soleus muscle, stretch therapy induced muscular healing as evidenced by muscle fiber hypertrophy and collagen bundle reorganization (Coutinho et al., 2006). Similarly, positive responses to treadmill training in spinal cord contusion injury were found in rats (Stevens et al., 2006).

A subset of rehabilitation, hydrotherapy, is an ancient medical discipline that involves the use of water to treat disease, including pain. In humans, hydrotherapy is used in the management of painful conditions varying from osteoarthritis (Balint and Szebenyi, 1997) to post-operative analgesia and wound care (Juve Meeker, 1998). Few well-controlled trials of analgesic efficacy in animals exist. As a component of an aquatic exercise program in humans, good documentation exists of improved strength, muscular endurance, cardiac fitness, agility, range of motion, and psychological well-being (Levine et al., 2004). As with many modalities that involve exercise, release of endogenous endorphins is a putative mechanism, as is strengthening of core muscles to support painful joints. Hydrotherapy permits unloading of joints during physical therapy and exercise, decreases edema and swelling due to hydrostatic pressure, and provides resistance exercise (Levine et al., 2004).

Hydrotherapy recommendations for use in small animal medicine were published in the 1970s, but appear to have been largely set aside until the emergence of canine rehabilitation medicine in the late 1990s (Downer, 1977, 1979). One set of case reports documented significant improvement in healing of tendon and ligamentous injury in horses treated with 10 minutes of hypertonic cold water spa bath hydrotherapy three times a week (Hunt, 2001). Swimming, walking on treadmills under water, and range of motion exercises performed in a whirlpool are all emerging modalities in canine rehabilitation medicine. As the analgesic benefits to hydrotherapy are largely “unproven” in animals, and as it requires some expertise and equipment, it would be difficult to recommend it as a therapeutic modality for laboratory animals, unless it fulfilled a rehabilitative role as well.

A review of veterinary textbooks and of the human literature can provide additional guidelines for development of rehabilitation protocols for laboratory animals, and sample programs for rehabilitation of specific injuries. Veterinarians may obtain certification and training in rehabilitation medicine through continuing education programs, though options are limited in scope, and formalized inclusion of physical therapy principles in primary veterinary education is lacking. Web-based resources for training are also available.

2. *Massage*

Massage has been advocated for relief of acute or chronic pain and also serves a diagnostic role in that manual contact with the animal's body allows abnormalities to be detected. Potential (not necessarily proven) benefits include enhanced tissue repair, analgesia (by descending pain inhibitory mechanisms), improvement of mood, and reduction of edema. Postulated mechanisms include local relief of ischemia (in muscle spasm or trigger points) via enhanced blood flow and tissue warming, mechanical stretching of muscles and fascia, and pain relief by endogenous endorphin production (Wright and Sluka, 2001). Massage in a distal-to-proximal direction is purported to move fluid in peripheral tissue into the core of the body to facilitate drainage; improved comfort would result from reduction of edema. Additional mechanisms of relief include alterations in muscle spindle length and increased range of motion, increased levels of serum serotonin, dopamine, and endorphins, and decreased excitability of alpha motoneurons (Linchitz and Sorell, 2000; Sullivan et al., 1991; Sutton, 2004).

A number of standardized massage techniques are used; examples include stroking (application of the hands with light pressure from proximal to distal), effleurage (performed in a distal-to-proximal direction with medium pressure to relax muscular spasm and stretch tissues mildly), compression (performed from proximal to distal, with a firm skin contact that depresses underlying tissues in a circular motion), and wringing (applying alternating directions of pressure with both hands on the same region of tissue) (Sutton, 2004). Various other techniques are described, but scientific evidence for the analgesic benefit of massage in animals is not available.

Members of some larger animal species will actively seek out human contact and could be accustomed to massage, but it is doubtful whether this would be true for animals such as rabbits or rodents. Thus, massage may have a place in the laboratory animal facility, although it can be time intensive. Contraindications to massage include shock, hypotension, fever, acute inflammation, infection, open wounds or unstable fractures, skin disease, and acute viral disease (Sutton, 2004).

3. *Chiropractic Manipulation*

Joint manipulation/mobilization is the basis of chiropractic medicine. Chiropractic intervention involves manual manipulation of joints (usually spine but other joints such as those of the skull are targeted) which are moved to or just beyond their normal range of motion, "freeing up" spinal nerves to treat disease or pain. Although randomized controlled trials (human) of manipulation for certain conditions (acute low back pain, cervical pain) have shown improvements over placebo, the duration of effect is noted to be short (Wright and Sluka, 2001).

Chiropractic adjustment of animals is currently performed either by veterinarians trained in chiropractic manipulation or by chiropractors under the supervision of veterinarians. The

American Veterinary Chiropractic Association offers training and certification. Research into chiropractic efficacy is ongoing. Due to the lack of information about efficacy and the need for specialized training, chiropractic manipulation is not a recommended treatment modality for nonpharmacologic pain control in laboratory animals.

C. *Electroanalgesia*

Electroanalgesia is widely applied for chronic pain management in humans, and increasingly in veterinary medicine. Stimulation can be provided by various methods. Electroanalgesia modulates the central nervous system in different ways depending upon the frequency and intensity of the electrical signal used, as well as the position of electrodes. High-frequency, low-intensity stimulation (the basis for transcutaneous electrical nerve stimulation or TENS) is most commonly used for the stimulation of sensory fibers, while low-frequency and high-intensity stimulation stimulates muscular contractions (the basis for electrical muscle stimulation or EMS) (Johnson and Levine, 2004; Wright and Sluka, 2001). Current can also be applied to acupuncture points to produce analgesia.

One of the most commonly used methods for pain relief, TENS, produces predominantly a superficial stimulus and is believed to have two mechanistic bases. One is based on the "gate theory" of pain; by stimulation of peripheral sensory (nonpain) nerve fibers, impulses are sent to the substantia gelatinosa of the spinal cord, which "closes the gate" to pain impulses from ascending (pain) C fibers. Production of endogenous opioid is also a postulated mechanism (Garrison and Foreman, 1994; Melzack and Wall, 1965; Wright and Sluka, 2001). The physiologic effects also include vasodilation, change in skin temperature, and production of a local inflammatory reaction (Johnson and Levine, 2004; McCauley and Glinski, 2004; Sluka, 2001). TENS is used for an extensive variety of painful conditions in humans, including obstetric, dental procedures, surgical procedures, arthritis, neuropathy, and back pain, although effectiveness compared to placebo is challenging to prove. Evidence exists for efficacy of TENS as a primary analgesic treatment in multiple rodent disease models, including peripheral neuropathy (Inoue et al., 2003) and inflammatory myopathy (Ainsworth et al., 2006). One study demonstrated control of visceral pain in mice as well (Lopez et al., 2004).

TENS devices range in price and capabilities, and can only be bought with a prescription. TENS requires only a minimum of technical expertise to operate, and can be used for procedural, post-operative, acute and chronic, musculoskeletal, and neuropathic pain. Effects of treatment sessions may be cumulative and may also not last once terminated. Contraindications include administration of TENS in desensitized regions of the body, malignancy, vascular disease, over a pacemaker and where an implant is present (Johnson and Levine, 2004). Animals may require gradual acclimatization to the mild tingling sensation

that it produces with use, but may receive positive reinforcement from the analgesic effects.

Other forms of electrical stimulation may be used, such as electroacupuncture for pain, and neuromuscular electrical stimulation (NMES), or EMS, for producing muscle contractions. The latter two modalities, while not primarily analgesic therapies, may reduce pain by improving strength. The complexity of the literature supporting TENS or other electrical stimulation techniques as a form of nonpharmacologic pain relief suggests that it may be difficult to adapt or justify its use in laboratory animals; however, in cases where analgesic drugs cannot be used, TENS therapy may offer partial relief of pain in laboratory animals.

D. Acupuncture

Acupuncture is a discipline of stimulation of “acupoints” on the body surface by means of a solid needle, with or without electrical stimulation, or by means of injection of solutions. Such stimulation is thought to alter biochemical and physical properties of the body. Acupoints exist along specific pathways or “meridians” and show evidence of increased electrical resistance. The histologic identity of the acupoint per se is not established, but an increased density of capillaries, arterioles, fine lymphatics, and a higher concentration of mast cells have been found (Lindley and Cummings, 2006). Both Traditional Chinese Medicine (TCM, a 4,000-year-old practice) and Western medicine approaches to acupuncture are used in the United States in humans as well as in animals. TCM practitioners refer to the “bioelectricity flow” along and between meridians as “Qi” (pronounced as “chee”). Acupuncture points in animals (horses) have been described both from original TCM teaching and by transposition from human charts. Published charts for the majority of laboratory animal species are not available. A web-published bibliography from the University of Montreal (<http://users.med.ath.gr/~karanik/english/articles/vetbibl.html>) gives a number of useful papers upon which to establish acupoint identity in birds, cattle, horses, dogs, cats, and pigs. The International Veterinary Acupuncture Society, the American Academy of Veterinary Acupuncture, and a growing number of textbooks also provide acupuncture charts in companion and large animal species. Identification of points of low transcutaneous electrical resistance, using a handheld device, can further help to definitively establish the location of acupoints (Trentini et al., 2005).

Locally, insertion of the needle at an acupoint stimulates A delta fibers and activates interneurons in the dorsal horn, producing enkephalins that inhibit C fibers (segmental analgesia) (Lindley and Cummings, 2006). At the site vasodilation and mast cell degranulation also occurs. Descending inhibition of pain is enhanced, as is humoral (general) modulation of pain (Clemmons, 2007). Effects of acupuncture can largely be blocked by administration of naloxone, but systemic levels

of serotonin, growth hormone, oxytocin, LH, leukocytes, interferon, etc., can also be altered, thus refuting the opioid-only mechanism theory (McCauley and Glinski, 2004; Wright and Sluka, 2001).

There is a substantial amount of ongoing research to validate transposition of acupoints from humans to other species, as well as to elucidate the mechanisms and efficacy of treatment. Documentation of acupuncture analgesia and disease treatment can be found for both human and veterinary applications. In 1997, the National Institutes of Health released a consensus paper that stated that acupuncture was useful for musculoskeletal pain, osteoarthritis, immunomodulation, gastrointestinal, pulmonary, and reproductive pathologies, as well as addiction and stroke rehabilitation (National Institutes of Health, 1997). As much of the data generated in experimental studies supporting this report was produced in laboratory animals, specifically the mouse and rat, there is good primary information source available on the location of various acupoints and therapeutic applications for laboratory animal medicine. In 1998, the American Veterinary Medical Association released a position statement, classifying acupuncture as a medical or surgical procedure, and recommending specific training for veterinarians. Interestingly, a recent study reviewing the literature on domestic animals, not laboratory animals, concluded that in 31 studies, the literature did not demonstrate conclusive evidence of efficacy of acupuncture (Habacher et al., 2006). Notwithstanding, the evidence in laboratory animal models, particularly rodents, supports the use of acupuncture for analgesia in specific applications.

Acupoints can be stimulated by a variety of methods, including finger pressure (known as acupressure), needles, and injection of saline or other solutions. Acupuncture needles come in a variety of sizes and shapes. Most commonly used are fine metal needles, with a tapered tip and metal handle, in a gauge range of 28–40 and length of 7–100 mm. Choice of needle is determined by therapeutic indication, and veterinary texts reference multiple options for insertion depth, angle, and techniques for manipulation upon placement in tissue. The intensity of the effect may be enhanced by application of current (electroacupuncture) or heat (moxibustion, heating of inserted needles with burning sticks of *Artemisia vulgaris*), or by “needling” (twisting of or probing with inserted needles). Most of the scientific literature supports either “dry” needling or electroacupuncture (Ferguson, 2007). The addition of various treatments to needling has been shown to be useful in a variety of applications. Electroacupuncture effectively reduced hyperalgesia induced by surgical incision on the plantar paw in rats (Oliveira and Prado, 2000). Manipulation of the needle during electroacupuncture was found to be more effective than simple electroacupuncture during tail flick latency in the rat (Kim et al., 2000). However, electroacupuncture in dogs with elbow joint osteoarthritis did not improve pain scores or alter ground reaction forces (Kapatkin et al., 2006). Continuous, high-frequency stimulation (80–120 Hz) is recommended for pain and muscle spasm, and lower frequency (5–20 Hz), intermittent stimulation

is recommended for motor neuron disease (Ferguson, 2007). The frequency and duration of acupuncture treatment is governed at least in part by response to treatment, but 20 minutes weekly for 4–6 treatments has been recommended for clinical practice (Lindley and Cummings, 2006). Improvement is usually seen in 1–3 days.

Contraindications to acupuncture therapy include presence of local skin disease, coagulopathy, hemodynamic shock, immunosuppression, and pregnancy (McCauley and Gliniski, 2004). As with all adjunctive treatments, careful, objective, and rigorous application of acupuncture and associated therapies may be considered a potential tool for providing pain relief. Personnel with training in acupuncture are not likely to be widely available in laboratory animal settings. However, insertion of needles is not difficult and a number of general points may be learned that can provide general pain relief, and so acupuncture should not be entirely discarded as unrealistic modality for some laboratory animal applications.

IV. SUMMARY AND FUTURE SCOPE

Scientific evidence to demonstrate the efficacy of a given technique compared to placebo is required in order for that technique to be medically accepted. Evidence is slowly mounting for the benefit of some nondrug techniques in humans, while others continue to be poorly studied or may be difficult to study. Many have been studied in human clinical as well as animal models, but relatively few studies have been attempted to date in clinical veterinary patients. Even the number of clinical trials in support of analgesic *drugs* for use in animals is quite small, and limited by (1) lack of validated pain scales or other methods for quantification of pain; and (2) lack of funding; it is therefore understandable that nondrug techniques will continue to be plagued by lack of scientific evidence of effectiveness in animals. On the other hand, a thoughtful consideration of how animals are housed and handled offers a number of ways that unnecessary stress and tissue injury can be reduced, thus minimizing pain. It is possible to immediately put certain changes into practice with little extra trouble or expense, and the “art” of managing animals continues to be shared through technique papers and education. It appears that cryotherapy and superficial heat might be easily incorporated into laboratory animal practice without the need for specialized training. Other techniques may fail to gain widespread acceptance if they cannot be shown to be effective and merit implementation. However, it would seem to be worth the effort to continue to look for more ways to provide comfort, particularly if drug therapy is limited or poorly understood. New research studies, both in laboratory animal care and in nonpharmacological interventions are likely to be able to add to the comfort of future animal subjects.

REFERENCES

- Abed, J.M., McClure, S.R., Yaeger, M.J., and Evans, R.B. (2007). Immunohistochemical evaluation of substance P and calcitonin gene-related peptide in skin and periosteum after extracorporeal shock wave therapy and radial pressure wave therapy in sheep. *Am. J. Vet. Res.* **68**, 323–328.
- Ainsworth, L., Budelier, K., Clinesmith, M., Fiedler, A., Landstrom, R., Leeper, B., Moeller, L., Mutch, S., O’Dell, K., and Ross, J. (2006). Transcutaneous electrical nerve stimulation (TENS) reduces chronic hyperalgesia induced by muscle inflammation. *Pain* **120**, 182–187.
- Balint, G., and Szebenyi, B. (1997). Non-pharmacological therapies in osteoarthritis. *Baillieres Clin. Rheumatol.* **1**, 795–815.
- Beilin, B., Shavit, Y., Trabekin, E., Mordashev, B., Mayburd, E., Zeidel, A., and Bessler, H. (2003). The effects of postoperative pain management on immune response to surgery. *Anesth. Analg.* **97**, 822–827.
- Broseta, I., Rodriguez-Arias, M., Aguilar, M.A., and Minarro, J. (2005). Isolation decreases physical and motivational aspects of morphine withdrawal. *Behav. Pharmacol.* **16**, 131–138.
- Capitanio, J.P. (1999). Social experience and immune system measures in laboratory-housed macaques: Implications for management and research. *ILAR J.* **39**, 190–198.
- Charmandari, E., Tsigos, C., and Chrousos, B. (2005). Endocrinology of the stress response. *Ann. Rev. Physiol.* **67**, 259–284.
- Chesler, E.J., Wilson, S.G., Lariviere, W.R., Rodriguez-Zas, S.L., and Mogil, J.S. (2002). Identification and ranking of genetic and laboratory environmental factors influencing a behavioral trait, thermal nociception, via computational analysis of a large data archive. *Neurosci. Biobehav. Rev.* **26**, 907–923.
- Clemmons, R. (2007). Functional neuroanatomical physiology for acupuncture. In “Xie’s Veterinary Acupuncture.” Chap. 12, Blackwell, Inc., Ames, IA.
- Coutinho, E.L., DeLuca, C., Salvini, R.F., and Vidal B.C. (2006). Bouts of passive stretching after immobilization of the rat soleus muscle increase collagen macromolecular organization and muscle fiber area. *Connect. Tissue Res.* **47**, 278–286.
- Degabrielle, R.D., and Fell, L.R. (2001). Changes in behaviour, cortisol and lymphocyte types during isolation and group confinement of sheep. *Immunol. Cell Biol.* **79**, 583–589.
- Downer, A.H. (1977). Whirlpool therapy for animals. *Mod. Vet. Pract.* **58**, 39–42.
- Downer, A. (1979). Underwater exercise for animals. *Mod. Vet. Pract.* **60**, 115–118.
- Ferguson, B. (2007). Techniques of veterinary acupuncture and moxibustion. In “Xie’s Veterinary Acupuncture.” Chap. 11, Blackwell, Inc., Ames, IA.
- Garrison, D.W., and Foreman, R.D. (1994). Decreased activity of spontaneous and noxiously evoked dorsal horn cells during transcutaneous electrical nerve stimulation (TENS). *Pain* **58**, 309–315.
- Gregory, N.G. (2004). “Physiology and Behaviour of Animal Suffering,” Blackwell Science, Ames, p 73.
- Guyton, A.C. (1986). “Textbook of Medical Physiology,” 7th ed., p 336. W.B. Saunders, Philadelphia.
- Habacher, G., Pittler, M.H., and Ernst, E. (2006). Effectiveness of acupuncture in veterinary medicine: Systematic review. *J. Vet. Intern. Med.* **20**, 480–488.
- Heinrichs, K. (2004). *Superficial thermal modalities*. In “Canine Rehabilitation and Physical Therapy.” (D. Millis, D. Levine, and R.A. Taylor, eds.), pp 277–288. W.B. Saunders, St. Louis.
- Hourdebaigt, J. (2004). “Canine Massage: A Complete Reference Manual,” 2nd ed. Dogwise Publishing, Washington.
- Hunt, E.R. (2001). Response of twenty seven horses with lower leg injuries to cold spa bath hydrotherapy. *J. Equine Vet. Sci.* **21**(4), 188–193.
- IASP http://www.iasp-pain.org/AM/Template.cfm?Section=General_Resource_Links&Template=/CM/HTMLDisplay.cfm&ContentID=3058#Pain
- Inoue, T., Takenoshita, M., Shibata, M., Nishimura, M., Sakau, G., Shibata, S.C., and Mashimo, T. (2003). Long lasting effect of transcutaneous electrical nerve stimulation on the thermal hyperalgesia in the rat model of peripheral neuropathy. *J. Neurol. Sci.* **211**(1–2) 43–47.

- Johnson, J., and Levine, D. (2004). Electrical stimulation. In "Canine Rehabilitation and Physical Therapy." (D. Millis, D. Levine, and R.A. Taylor, eds.), pp 289–302. W.B. Saunders, St. Louis.
- Juve Meeker, V. (1998). Whirlpool therapy on postoperative pain and surgical wound healing: An exploration. *Patient Educ. Couns.* **33**, 39–48.
- Kapatkin, A.S., Tomasic, M., Beech, J., Meadows, C., Boston, R.C., Mayhew, P.D., Powers, M.Y., and Smith, G.K. (2006). Effects of electrostimulated acupuncture on ground reaction forces and pain scores in dogs with chronic elbow joint arthritis. *J. Am. Vet. Med. Assoc.* **228**, 1350–1354.
- Kehlet, H. (2004). *Effect of postoperative pain treatment on outcome—Current status and future strategies.* *Arch. Surg.* **389**, 244–249.
- Kim, J.H., Min, B.I., Schmidt, D., Lee, H.J., and Park, D.S. (2000). The difference between electroacupuncture only and electroacupuncture with manipulation on analgesia in rats. *Neurosci. Lett.* **279**, 149–152.
- Levine, D., Rittenberry, L., and Millis, D.L. (2004). Aquatic therapy. In "Canine Rehabilitation and Physical Therapy." (D. Millis, D. Levine, and R.A. Taylor, eds.), pp 264–276. W.B. Saunders, St. Louis.
- Linchitz, R.M., and Sorell, P.J. (2000). Physical methods of pain management. In "Practical Management of Pain." (P.P. Raj, ed.), 3rd ed., pp 529–543. Mosby, St. Louis.
- Lindley, S., and Cummings, M. (2006). "Essentials of Western Veterinary Acupuncture," Blackwell, Oxford, pp 33–37.
- Lopez, U.G., Campos Sepúlveda, A.E., Parra, J.G., Valenzuela, A.T., Fuentes, R.D., and Martínez Enriquez, M.E. (2004). Transcutaneous electrical nerve stimulation prevents visceral pain in mice. *Can. J. Anesth.* **51**, 400.
- Marsland, A.L., Bachen, E.A., Cohen, S., Rabin, B., and Manuck, S.B. (2002). Stress, immune reactivity and susceptibility to infectious disease. *Physiol. Behav.* **77**, 711–716.
- McCauley, L., and Glinski, M.H. (2004). Acupuncture. In "Canine Rehabilitation and Physical Therapy." (D. Millis, D. Levine, and R.A. Taylor, eds.), pp 337–403. W.B. Saunders, St. Louis.
- McEwen, B.S. (2004). Protection and damage from acute and chronic stress: Allostasis and allostatic overload and relevance to the pathophysiology of psychiatric disorders. *Ann. N.Y. Acad. Sci.* **1032**, 1–7.
- McGuire, L., Heffner, K., Glaser, R., Needleman, B., Malarkey, W., Dickinson, S., Lemeshow, S., Cook, C., Muscarella, P., Melvin, W.S., Ellison, E.C., and Kiecolt-Glaser, J.K. (2006). Pain and wound healing in surgical patients. *Ann. Behav. Med.* **1**, 165–172.
- Melzack, R., and Wall, P.D. (1965). Pain mechanisms: A new theory. *Science* **150**, 971–978.
- National Institutes of Health. (1997). Consensus Statement Online 15(5): http://odp.od.nih.gov/consensus/cons/107/107_statement.htm
- National Research Council. (1996). "Guide for the Care and Use of Laboratory Animals." National Academy Press, Washington.
- Oliveira, R., and Prado, W.A. (2000). Anti-hyperalgesic effect of electroacupuncture in a model of post-incisional pain in rats. *Braz. J. Med. Biol. Res.* **33**, 957–960.
- Panksepp, J. (1980). Brief social isolation, pain responsiveness, and morphine analgesia in young rats. *Psychopharmacology* **72**, 111–112.
- Popovic, M., Popovic, N., Eric-Jovicic, M., and Jovanova-Nesic, K. (2000). Immune responses in nucleus basalis magnocellularis-lesioned rats exposed to chronic isolation stress. *Int. J. Neurosci.* **100**, 125–131.
- Sluka, K.A. (2001). The basic science mechanisms of TENS and clinical implications. *APS Bull.* **11**, 2.
- Steiss, J.E., and Adamas, C.C. (1999). Rate of temperature increase in canine muscle during 1 MHz ultrasound therapy: Deleterious effect of hair coat. *Am. J. Vet. Res.* **60**, 76–80.
- Steiss, J.E., and McCauley, L. (2004). Therapeutic ultrasound. In "Canine Rehabilitation and Physical Therapy." (D. Millis, D. Levine, and R.A. Taylor, eds.), pp 325–336. W.B. Saunders, St. Louis.
- Stevens, J.E., Liu, M., Bose, P., O'Steen, W.A., Thompson, F.J., Anderson, D.K., and Vandeborne, K. (2006). Changes in soleus muscle function and fiber morphology with one week of locomotor training in spinal cord contusion injured rats. *J. Neurotrauma* **23**, 1671–1681.
- Sullivan, S.J., Williams, L.R.T., Seaborne, D.E., and Morelli, M. (1991). Effects of massage on alpha motoneuron excitability. *Phys. Ther.* **71**, 555–560.
- Sutton, A. (2004). Massage. In "Canine Rehabilitation and Physical Therapy." (D. Millis, D. Levine, and R.A. Taylor, eds.), pp 303–323. W.B. Saunders, St. Louis.
- Takahashi, L.K., Nakashima, B.R., Hong, H., and Watanabe, K. (2005). The smell of danger: A behavioral and neural analysis of predator odor-induced fear. *Neurosci. Biobehav. Rev.* **29**, 1157–1167.
- Trentini, J.F., Thompson, B., and Erlichman, J.S. (2005). The antinociceptive effect of acupressure in rats. *Am. J. Chin. Med.* **33**, 143–150.
- Tuchscherer, M., Kanitz, E., Puppe, B., Tuchscherer, A., and Stabenow, B. (2004). Effects of postnatal social isolation on hormonal and immune responses of pigs to an acute endotoxin challenge. *Physiol. Behav.* **82**, 503–511.
- Vissers, K., De Jongh, R., Hoffmann, V., Heylen, R., Crul, B., and Meert, T. (2003). Internal and external factors affecting the development of neuropathic pain in rodents. Is it all about pain? *Pain Pract.* **3**, 326–342.
- Watkins, L.R., and Maier, S.F. (2005). Immune regulation of central nervous system functions: From responses to pathological pain. *J. Int. Med.* **257**, 139–155.
- Wright, A., and Sluka, K.A. (2001). *Nonpharmacological treatments for musculoskeletal pain.* *Clin. J. Pain* **17**, 33–46.

Anesthetic Considerations for *In Vivo* Imaging Studies

Anthony Nicholson and Brenda Klaunberg

I. Introduction	629
II. Imaging Modalities	630
A. X-Ray-Based Technologies	630
B. Ultrasound	631
C. Optical	631
D. Magnetic Resonance Imaging and Spectroscopy (MRI/S)	632
E. Micropositron Emission Tomography (μ PET or MicroPET)	632
F. Single-Photon Emission Computed Tomography (SPECT)	632
G. Gating	632
III. Anesthetic Considerations	633
A. Body Temperature	633
B. Ventilation	633
C. Blood Pressure and Cardiac Function	634
D. Hydration and Metabolic Status	634
E. Effects of Repeated Anesthesia and Imaging	635
F. Effects of Strain, Sex, and Age	635
IV. Imaging-Specific Considerations	636
V. Anesthesia	636
A. Injectable Anesthesia	637
B. Inhalational Anesthesia	637
References	637

I. INTRODUCTION

The use of imaging modalities for examination of laboratory animals has increased significantly in the past 5–10 years. This increase has been in part due to the development of new

technologies, which parallel and expand on those used clinically, as well as advances in the production of genetically engineered animals, particularly mice. The numbers of such mice used in preclinical and basic research have increased enormously in recent years, to the extent that mice are the most commonly used

models for investigating human disease. Advances in imaging technology have accompanied this growth such that most imaging modalities currently available clinically are now available for use with mice, together with some that are strictly research tools. A major impetus for researchers to use *in vivo* imaging in their investigations is that it can provide information regarding longitudinal changes in the same animals (Abbey et al., 2004), and thus its use greatly reduces the number of animals required for any given study (Lewis et al., 2002). Research imaging devices are increasingly being described as molecular imaging tools as these new modalities provide unique methods to assess *in vivo* tissue function. Many of these methods are capable of taking advantage of genetic probes and markers that are most frequently developed for use in mice (Cherry and Gambhir, 2001; Hildebrandt and Gambhir, 2004; Ntziachristos et al., 2003; Weissleder and Mahmood, 2001; Weissleder and Ntziachristos, 2003). Due to the need for increased resolution of these instruments, often two to three orders of magnitude greater than that achievable with human, or even veterinary, clinical equivalent systems, preclinical imaging devices are generally referred to as “micro” for microscopy (Budinger et al., 1999; Holdsworth and Thornton, 2002; Massoud and Gambhir, 2003; Weissleder, 2002). In conjunction with these developments has been the need to improve methods to anesthetize mice and other laboratory animals and monitor their physiological well-being throughout the peri-imaging period.

The aim of this chapter is to briefly introduce the modern researcher to the wealth of imaging modalities available and discuss available and appropriate methods of anesthesia. Recommendations will be made for general approaches to the anesthesia of animals for each of these techniques including specific and unique considerations associated with each modality where appropriate. Limited mention will be made of the specific pharmacology of anesthetics used for imaging other than where they may adversely affect the results of the imaging process. Similarly, specific drug protocols and dose rates will not be outlined unless deemed directly relevant. Since details about drugs or specific delivery techniques for various laboratory animals are listed in other chapters of this book, we recommend readers refer to the appropriate chapters for specific anesthetic protocol details, and to Chapters 2 and 3 for discussions on pharmacology of injectable and inhalant anesthetics, respectively. Discussions in this chapter will be limited to species used most frequently for imaging studies: mice, rats, and nonhuman primates (NHP). Other species for which imaging may be part of a research protocol include swine, dogs, and guinea pigs. However, due to the increasing interest in and approaching clinical application of many of these techniques (Weissleder, 2006), and the fact that most of the development of these techniques is occurring with rodents, the major emphasis of this chapter will be on these species.

We will make special mention of the features unique to a particular modality that may impact anesthesia, such as the need for nonferrous anesthesia and monitoring systems for magnetic

resonance imaging (MRI). We will make recommendations for monitoring of animals during imaging procedures, for example, which monitoring devices are most suitable and convenient, as well as address the need for patient maintenance with fluids and heat. We will also discuss the impact of anesthesia on experimental outcome, particularly its influence on normal physiology.

II. IMAGING MODALITIES

A. X-Ray-Based Technologies

These include systems for imaging animals with standard X-rays, dual-energy X-ray absorptiometry (DEXA) for body composition analysis, and microcomputed tomography (μ CT or microCT). Standard radiographic examinations and DEXA analysis generally require animals to be still for a matter of several minutes; for example, DEXA analysis with the Lunar PIXImus™ takes 6–7 minutes per animal. Data acquisition with μ CT can take as few as 5 minutes to upward of an hour depending on the system being used and acquisition settings, particularly the resolution, number of projections required, and whether gating is used (see below for discussion of gating) (Paulus et al., 2000).

1. Radiography

There are several systems designed for two-dimensional radiography of small laboratory animals. The most widely available are the Faxitron® systems. These are now available in digital formats, removing the need for film and its development, although earlier analog systems are still commonly used. These systems provide a 5 \times -magnified image resulting in high-resolution radiographs.

2. Dual-energy X-ray Absorptiometry

This technology uses X-rays of two different energy levels that are absorbed differentially by various body tissue types. This enables differentiation of the body mass into three classes: mineralized tissue (bone), fat tissue, and lean tissue, which includes muscle, visceral organs, and skin. Although this technique is used primarily to provide information about body composition, it is included here as the data are presented in graphical format (mineralized tissue outlined over a low-resolution radiograph), as well as numerical data similar to other *in vivo* imaging techniques (Akhter et al., 2000; Brommage, 2003).

3. Microcomputed Tomography

MicroCT involves the acquisition of a number of axial radiographic projections (slices) of the subject, which are

subsequently reconstructed to enable three-dimensional visualization of the region(s) of interest. Being X-ray based, μ CT is best used for examination of bone; however, it can provide good soft tissue definition depending on the acquisition protocol used. Soft tissue assessment can be further enhanced with the use of contrast agents, delivered orally, intraperitoneally, or intravascularly. The duration of data acquisition with μ CT depends on a number of factors, but the number of projections and the final image resolution have the most impact on imaging time. Depending on the particular system used, *in vivo* μ CT imaging is capable of a resolution of 15–25 μ m. The price for this high resolution is a significant increase in data file size and a greatly prolonged acquisition time. Increasing the number of projections acquired increases the signal-to-noise ratio (SNR) and improves soft tissue definition, but this also can significantly increase acquisition time and anesthetic duration (Cherry, 2004; Paulus et al., 2000, 2001). A high-resolution μ CT scan may take as long as 30–40 minutes. Additionally, longer acquisition times result in the animal receiving an increased dose of ionizing radiation. The long-term effects of radiation received during μ CT imaging are currently unknown, but must be considered if experimental results differ from expected outcomes, particularly in studies of tumor biology and therapeutics.

B. Ultrasound

There are two major classes of ultrasound systems available for imaging small laboratory animals: clinical systems that use relatively low-frequency probes (up to 15 MHz) and dedicated high-frequency systems that have probes ranging from 20 MHz to 55 MHz (Foster et al., 2002; Phoon and Turnbull, 2003; Wirtzfeld et al., 2005; Zhou et al., 2002, 2004). Each of these systems provides different advantages, and in some respects can be considered complimentary. Clinical systems provide specialized techniques such as color flow Doppler that is useful for cardiac examinations, whereas the high-frequency systems provide significantly higher resolution images at the cost of depth penetration. Most ultrasound examinations on small animals, especially mice, are done with the animals under general anesthesia; however, it is possible to perform short examinations in conscious animals. The need for anesthesia will depend on the inherent needs of the animal and their response to being handled and restrained, the tissue or organ being examined, and the impact of the stress response of the animal on the resultant data. It may be possible to train some animals to accept manual restraint sufficiently to allow echocardiography while conscious (Semenuk et al., 2002; Syed et al., 2005; Takuma et al., 2001; Wang et al., 2006; Yang et al., 1999). As with larger species, the duration of any ultrasound examination depends on the individual investigation, the ease of tissue access, and the type of information required (Balaban and Hampshire, 2001; Coatney, 2001).

C. Optical

An increasing variety of optical imaging technologies is available, many of which are designed exclusively for preclinical imaging. Many of these require genetic manipulation of either cells *in vitro*, which are subsequently implanted into the test animals, or the animal's genome, which is engineered to express the necessary proteins or enzymes (Wang et al., 2006). For example, xenografts or allografts are frequently used in cancer research to follow the progression of tumor implants, or more usually to follow the response to therapy following drug administration.

1. Fluorescence

An increasing number of genetic constructs are available for fluorophores that are commonly incorporated into the genome of mice. These genes code for particles that require subsequent excitation with light of the appropriate wavelength in order to be visible. This technique was first developed for examination of explanted tissues, but more and more techniques are being developed to enable *in vivo* examination (Cherry, 2004; Hassan and Klaunberg, 2004). These biomarkers can be used not only for identifying the location of particular cells, but can be engineered to signal a specific cell function such as gene activation (Ballou et al., 2005). They can also be tailored to fluoresce in a defined condition, such as the change in pH that occurs in endocytosis (Hama et al., 2006). Newer devices now allow visualization of *in vivo* fluorescence at the cellular level with fiberoptic technology and two-photon microscopy.

2. Bioluminescence

Bioluminescence results from the production of light by a biochemical reaction. This technique requires the presence of an active enzyme called luciferase and its substrate luciferin to allow visualization of the bioluminescence. The most commonly used luciferase is from fireflies and it produces light in green wavelengths. This reporter gene can be engineered to express ubiquitously as in a transgenic animal, or constructed to signal a specific cellular function (Contag and Bachmann, 2002; Zhou et al., 2004). Because there are no endogenous mammalian luciferase genes, it is a highly specific cell marker commonly used for cell tracking (Cherry, 2004; Sato et al., 2004).

Data acquisition for bioluminescence or fluorescence is similar. Image acquisition requires placing the anesthetized animal into a light-tight chamber to enable signal detection by a sensitive camera, i.e., a charge-coupled device (CCD). Typically, the optical image is superimposed on another image such as a low-resolution radiograph or photograph for anatomical reference. Fluorescence imaging is virtually instantaneous and an image can be generated within seconds. Bioluminescence requires a slight time delay for the biochemical reaction, but image acquisition usually takes less than 10 minutes.

3. Laser Doppler

Laser Doppler imaging (LDI) takes advantage of the Doppler effect to measure blood flow. A laser light is directed over the tissue in a scanning pattern. The laser energy is absorbed, scattered, and reflected by moving objects such as red blood cells, and the change in frequency is proportional to the cells' velocity. The system uses an algorithm to generate a measurement of laser Doppler flux related to the amount of blood flow. The wavelength of the laser determines the depth of penetration, but typically it measures capillary blood flow within the top 1 mm of tissue. Imaging can take anywhere from 10 minutes to 30 minutes depending on the area of interest (Baudelet and Gallez, 2004; Shireman and Quinones, 2005).

D. Magnetic Resonance Imaging and Spectroscopy (MRI/S)

MRI uses the nuclear property of intrinsic spin to form images of certain nuclear isotopes (nuclides) by manipulating magnetic fields to create radiograph-like images without using ionizing radiation. The most common nuclide in the body is hydrogen (^1H). The hydrogen found in water and fat is commonly used to generate high-resolution images (pixel size 200 μm isotropic or less) of small laboratory animals with adequate image intensity or SNR. A more intense magnetic field provides a higher image SNR, which can be used for increased imaging resolution (Chatham and Blackband, 2001; Pautler, 2004). Most of the MRI systems used for laboratory animal imaging have significantly higher magnetic field strength than clinical MRI systems. However, clinical MRI systems can be used for animal research by using specifically designed coils to generate adequate images of small animals.

MRI is useful to study a variety of organs, but is exceptional when examining the central nervous system. Special imaging techniques utilizing contrast agents or endogenous tissue properties can provide functional information such as changes in blood flow or oxygenation. Magnetic resonance spectroscopy confines the image acquisition to the spectral information of a particular nuclide. This is useful for imaging tissue distribution of a particular drug or metabolite; however, the nuclide of interest is often present in low concentrations and may result in an image of low SNR with poor spatial and temporal resolution (Balaban and Hampshire, 2001; McConville et al., 2005; Pautler, 2004). MR images can be acquired as quickly as within a few minutes, but generally experiments require longer scan times. As with other imaging modalities, the size of the region of interest, final image resolution, and need for three-dimensional data determine the entire scan time. Depending on the scan parameters, *in vivo* imaging can take as long as several hours. It is important to remember that the animals are imaged at a distance from the anesthetist; therefore, most small animals are typically inaccessible during imaging. It is sometimes possible,

however, to have some access to larger animals for injections or monitoring.

E. Micropositron Emission Tomography (μ PET or MicroPET)

MicroPET imaging uses a series of highly sensitive detectors to capture the photons generated when a radionuclide injected into the body of the test animal disintegrates. This highly specialized technology provides functional and metabolic information according to the type of isotope and radiochemistry used. Although it is extremely sensitive, μ PET provides poor spatial resolution and consequently is often used in conjunction with other modalities such as μ CT or MRI that provide anatomical landmarks. To maximize the combination of these two modalities, the images from each need to be coregistered to provide the most concise information. This necessitates data acquisition from each consecutively, and ideally simultaneously, which can significantly extend the anesthesia time. PET imaging time also depends on whether it is a static imaging experiment acquired at a single tracer timepoint, or a dynamic study where time distribution of a tracer is needed (Cherry, 2004; Cherry and Gambhir, 2001; Martiniova et al., 2006; Paulus et al., 2001). Additionally, image acquisition time is inversely proportional to the tracer concentration. Shorter scans are often adequate; however, acquisition times can take as long as 2–4 hours, not including the time for μ CT or MRI imaging for coregistration.

F. Single-Photon Emission Computed Tomography (SPECT)

This technique is similar to μ PET in that it utilizes radionuclides. The isotopes for SPECT are usually different from those used in PET and generally have longer half-lives. These instruments can be single-function-dedicated machines, or more commonly these days they are made in combination with μ CT. Dual-function machines simplify the problem of registration for combining the two images. SPECT, as with PET, provides poor tissue localization, hence the tendency to combine it with CT (Cherry, 2004; Paulus et al., 2001).

G. Gating

Some imaging techniques are improved by the timing of image acquisition with specific stages of the respiratory or cardiac cycles; this technique is referred to as gating, either respiratory or cardiac. Respiratory gating is a useful and robust technique routinely employed in CT and MRI imaging (Ford et al., 2007). Cardiac gating is commonly used in MRI for all species and in clinical CT scanners for large animals, but is currently in development for use with small animals and preclinical CT scanners.

Respiratory gating is simplest to achieve by methods that detect the changes in thoracic or airway pressure associated with respiration. A pressure sensitive balloon, placed under the thoracolumbar junction attached to a pressure transducer, is an effective noninvasive method to achieve respiratory gating. Detection of changes in airway pressure is possible when anesthesia is maintained by the use of a cone or face mask for delivery; however, this method is far more reliable if the animals are intubated. Noncuffed endotracheal tubes suitable for rodents are now commercially available, but intravenous catheters have been used successfully. These tools are nonferrous and therefore MRI compatible. If animals are intubated, another method to achieve respiratory gating is to mechanically ventilate the animals and use a signal from the ventilator to trigger the MRI.

Cardiac gating requires monitoring of cardiac electrical activity, i.e., an electrocardiogram. Using this signal, the MRI can be triggered to acquire data repeatedly at the various discrete stages of the cardiac cycle. The ability to gate depends on both the amount of time required for image or data acquisition, usually in the order of milliseconds, and the frequency of either the heart rate, usually in excess of 400 beats per minute (bpm), or respiration rate, generally greater than 50 breaths per minute for smaller rodents. With the exception of MRI, none of the other imaging modalities commercially available at this time acquire data rapidly enough to benefit from cardiac gating when imaging rodents. In addition, many cannot take advantage of respiratory gating either, but the technologies are rapidly advancing for both cardiac and respiratory gating. Gating is used to further limit subject movement during image acquisition; for μ CT respiratory gating results in improved image quality of thoracic contents as well as organs of the proximal abdomen that can move significantly due to diaphragmatic movement (Ritman, 2005; Ruff et al., 2000).

III. ANESTHETIC CONSIDERATIONS

The fundamental purpose for anesthetizing animals for imaging is to keep them as still as possible in order to minimize movement artifact and so maximize image quality (Balaban and Hampshire, 2001). For the most part, animals used in imaging studies tend to be overtly healthy, although this is dependent on the genetic modifications and the nature of the experiment. Genetically altered animals may express an unusual or unexpected phenotype that can impact their response to anesthesia or specific anesthetic agents. Such variations may or may not be obvious or even significant; however, one should be aware of the possibility that these may exist. At other times, animals' health will be severely compromised and consideration must be given to best minimize any disturbances in normal function due to anesthesia.

The impact of general anesthesia, or of particular anesthetics, on subject physiology should be a major consideration

when choosing an anesthetic approach for imaging studies. This impact can be most profound in those studies that are designed to assess some aspect of physiological function. Modalities most affected by these perturbations are PET, functional MRI (fMRI), and ultrasound. Despite this caveat, many of the standard small animal anesthesia techniques are appropriate for most of these imaging modalities. In many instances either injectable or inhalational anesthesia can be used, although inhalational techniques provide the greatest flexibility and are generally best for longer procedures (Balaban and Hampshire, 2001; Colby and Morenko, 2004). Regardless of the type of anesthetic used, physiological monitoring of the animal during the procedure and appropriate recovery are critical to the well-being of the animal and success of the study.

A. Body Temperature

Maintenance of normal body temperature is an important consideration when imaging small animals, both because of the potential affect of hypothermia on response to anesthesia and recovery, and also for its potential impact on other physiological processes. Blood flow and distribution are sensitive to alterations in body temperature, especially decreases. Due to their small size and large body surface to body weight ratio, small laboratory animals tend to lose body heat rapidly when anesthetized. This is due to loss of homeothermic control as a result of anesthesia, compounded by an average laboratory ambient temperature well below the animals' core body temperature. Therefore, provision of an external form of heat is mandatory for any procedure that lasts more than about 10 minutes. Methods of applying heat include circulating water blankets, heat pads, and circulating warm air through the imaging device. Some devices are equipped with warming platforms on which the animals are imaged. If these methods are not possible, then wrapping animals in bubble wrap, if appropriate for the imaging technique (e.g., μ CT), will lower the rate of heat loss by the animals, although this is less effective than supplying heat.

B. Ventilation

Due to the extended acquisition times associated with many imaging modalities, adequacy of ventilation, and airway patency are major considerations. Animals may hypoventilate, which can result in concomitant hypoxemia, hypercapnia, and associated respiratory acidosis. These conditions may cause serious metabolic imbalances that can affect study results. An endotracheal tube ensures airway access and will afford the anesthetist control of the animal's ventilation. Despite its apparent difficulty, intubation of mice, rats, and other species can become routine with time, patience, and practice. Several different techniques have been described in the literature (Brown et al., 1999; Cavanaugh et al., 2004; Rivera et al., 2005; Winning

et al., 2004). The value of mastering this skill is considerable, particularly for long procedures and those to be repeated for longitudinal studies.

Animals that are intubated can be readily ventilated to maintain normoxia and normocapnia. However, care should be taken when ventilating rodents to avoid hyperinflation that can cause barotrauma to the lungs. Both the thoracic wall and lungs of mice are compliant, so do not require high inflation pressures for adequate ventilation (Cavanaugh et al., 2004; Schwarte et al., 2000; Soutiere and Mitzner, 2004). Hyperinflation can occur from too high a pressure or too large a tidal volume being delivered. In general, one should not exceed ventilatory pressures of 20 cmH₂O, or deliver tidal volumes above 15 ml/kg. Thal and Plesnila (2007) were able to maintain mice with PaCO₂ and ETICO₂ at levels around 38 ± 6 mmHg for several hours by delivering approximately 10 μl/g (10 ml/kg) of a 70% nitrogen–30% oxygen gas mixture at 100–120 breaths per minute using a delivered pressure of only 11 cmH₂O. Similarly, inspiratory pressures as low as 5 cmH₂O have been used in the rat to achieve comparable CO₂ levels (Mirsattari et al., 2005). Apart from barotrauma, hyperventilation or hypoventilation can also have metabolic sequelae. Respiratory alkalosis due to excess removal of CO₂ is the most common result of overly enthusiastic artificial ventilation. Hyperinflation can also cause direct cardiovascular problems due to impeding passive venous return of blood to the heart resulting in hypotension due to inadequate ventricular filling (Zuurbier et al., 2002).

Normal ventilatory settings are generally based on a tidal volume of 10 ml/kg. Respiratory rate tends to be body mass dependent, being as high as 150–200 breaths per minute for mice to as low as 20–40 breaths per minute for some NHP. The best way to ensure adequate and appropriate ventilation is to measure arterial blood gases. There are unfortunately a number of logistical problems to this approach for most laboratory animals. Blood gas machines are expensive, often beyond the budgets of research groups, although smaller units, including handheld ones are available. Most of these systems require relatively large volumes of arterial blood. Access and quantity are limiting factors for performing these measurements in rodents, especially mice that have a circulating blood volume of around 2 ml (Diehl et al., 2001). Another method to assess adequacy of ventilation is to measure the end-tidal CO₂ (ETICO₂) concentration. In rodents, small body size, small tidal volumes, and high respiratory rates make ETICO₂ a difficult methodology to employ reliably. These two techniques are more easily adapted to NHP and other larger species.

Pulse oximetry provides an indirect measure of ventilatory adequacy as well as perfusion, both centrally and peripherally. There are many small animal pulse oximeters available; however, the majority of these have difficulty with the high pulse rates of rodents, so may not function effectively. A new rodent-specific pulse oximeter is reported to monitor hemoglobin saturation in animals at pulse rates up to 900 per minute (Strohl et al., 2005).

C. Blood Pressure and Cardiac Function

Maintenance of cardiovascular function is important for some functional imaging modalities, due to their dependence on normal blood flow and distribution for reliable measurements. This is particularly important for studies dependent on normal cerebral blood flow distribution. Significant perturbations of cardiovascular function may occur during anesthesia, depending on the anesthetic used, level of anesthesia attained, and duration of anesthesia. In mice, isoflurane is the most commonly used anesthetic considered to cause the least cardiovascular disturbance, with tribromoethanol (TBE) reasonable for short procedures and ketamine/xylazine combinations generally considered to be most deleterious (Hart et al., 2001; Janssen et al., 2004; Zuurbier et al., 2002). Unfortunately, there are no reliable noninvasive methods for monitoring cardiac function in anesthetized mice, although this is somewhat easier in rats and NHP. For mice, the most frequent measure of cardiac function during imaging is assessment of heart rhythm and rate via electrocardiography (ECG). As with other species, light-weight, nonferrous leads are necessary, particularly with MRI.

When assessing murine cardiac function by ultrasound, i.e., echocardiography, it is recommended that the heart rate be maintained at greater than 400–450 bpm (Dawson et al., 2004; Takuma et al., 2001). This provides meaningful measurements that approximate those of conscious animals, in which heart rate ranges from around 550 bpm to 700 bpm depending on the strain and the level of activity at the time of measurement (Chu et al., 2006; Kawahara et al., 2005; Kiatchosakun et al., 2001; Roth et al., 2002; Yang et al., 1999). MRI is also used to assess cardiac function, and concerns are compounded by limited subject access during image acquisition (Balaban and Hampshire, 2001; Chacko et al., 2000; Kober et al., 2004; Ruff et al., 2000). More recently, microPET has also been used to assess cardiac function (Kreissl et al., 2006). Gaseous anesthetics, such as isoflurane, enable much greater ability to control heart rate under these circumstances through control of depth of anesthesia and are often preferred for this reason.

Other than invasive techniques, it is difficult to measure blood pressure reliably in mice during imaging. However, the Doppler piezoelectric crystal method has been used on the tail of mice and rats with some success (Thal and Plesnila, 2007). Doppler and oscillometric methods, e.g., Dinamap™, are suitable for NHP in some imaging systems.

D. Hydration and Metabolic Status

Fluid and electrolyte balance, as well as blood glucose levels, need to be considered when imaging small animals for long periods. In general, there is no need to fast rodents prior to anesthesia, because neither mice nor rats are able to vomit and there is little risk of gastric reflux and aspiration. This reduces the likelihood of animals becoming hypoglycemic during standard

imaging sessions. On the other hand, the stress of anesthesia itself raises blood glucose levels, in a drug-dependent manner, with the most marked increases occurring when administering alpha-2 agonists, such as xylazine (Church et al., 1994; Pomplun et al., 2004; Vera et al., 2002). This effect may be attenuated with overnight fasting (Lee et al., 2005). If a prolonged procedure is anticipated, or ensues due to complications, blood glucose should be measured, if possible, or dextrose preemptively added to the supplemental fluids to avoid hypoglycemia (Zuurbier et al., 2002). However, use of additional glucose should be done judiciously to avoid problems of hyperglycemia. If in doubt, measure plasma glucose before supplementing any IV fluids.

Consideration should also be given to the imaging modality in use, duration of the procedure, the size of the animals, time of last feed, and the type of anesthetic administered. In μ PET studies, the most commonly used marker is 2-deoxy-2-[18 F]fluoro-D-glucose (18 F-FDG), a glucose analog that is taken up by cells in place of glucose. The uptake of 18 F-FDG is significantly affected by some anesthetics, as well as prior fasting and body temperature (Fueger et al., 2006; Itoh et al., 2005; Lee et al., 2005; Toyama et al., 2004). The anesthesia-associated hyperglycemia, particularly that associated with xylazine, may result in competition for uptake of 18 F-FDG by cells, with varying results among different anesthetic protocols (Fueger et al., 2006; Itoh et al., 2005; Lee et al., 2005; Toyama et al., 2004). Therefore, it is critical to use a consistent anesthetic protocol for functional and molecular imaging studies, and to take into consideration the physiologic effects of different anesthetics.

Normal saline or other balanced electrolyte solutions can be given continuously throughout image acquisition if the animal is catheterized, and if not, then intraperitoneal (IP) fluids can be administered to rodents either pre- and/or postprocedure. Fluids administered IP are absorbed into the vascular system rapidly and are therefore an effective way to provide fluid replacement therapy without vascular access. Preheating of administered fluid will help reduce the heat loss during anesthesia.

E. Effects of Repeated Anesthesia and Imaging

One of the major reasons for *in vivo* imaging is that it enables the investigator to re-image the same animal over time. This means that individual animals can act as their own controls, reducing the number of animals used in a given experiment (Abbey et al., 2004; Lewis et al., 2002). An important consideration for repeated scanning of animals is the frequency and time interval between imaging sessions. For chronic studies with a limited number of episodes of imaging over a period of months, the choice of anesthetic is less likely to negatively impact the animals. However, for shorter studies, or those with a short interval between imaging sessions, the choice of anesthetic may have a significant effect on the animal.

Less so now than in the past, TBE is used for some short imaging sessions in rodents because it is relatively short-acting,

is easy to administer, and is inexpensive. Repeated administration of this drug to the same animal has been reported to cause a number of problems in both mice and rats (Papaioannou and Fox, 1993; Reid et al., 1999; Thompson et al., 2002; Weiss and Zimmermann, 1999; Zeller et al., 1998). The evidence regarding these problems is limited and somewhat inconsistent and empirical, but a general consensus is that when administered IP, as it usually is, TBE may cause paralytic ileus, mild-to-moderate peritonitis, hepatic inflammatory infiltration, and fibrosis or necrosis of abdominal wall musculature (Lieggi et al., 2005; Papaioannou and Fox, 1993; Reid et al., 1999; Zeller et al., 1998). These adverse events most often manifest themselves upon repeated exposure to the drug rather than on initial use. Some of these problems may be due to the instability of working solutions of the drug, which are light-sensitive. It is generally recommended that for its safe use, the working solution of TBE be made up fresh every 2 weeks and that it be protected from exposure to light (Lieggi et al., 2005; Papaioannou and Fox, 1993).

Frequent repeated use of some injectable agents and mixtures, such as ketamine and xylazine or medetomidine, can cause problems with prolonged recovery. Ketamine is metabolized in the liver and excreted via the kidneys. Some metabolites, such as norketamine, have anesthetic activities that contribute to prolongation of anesthetic action (Pawson and Forsyth, 2002). Excretion may be prolonged after repeated administration due to metabolite accumulation, which can contribute toward delayed recovery. This may be exacerbated by any impairment in renal function, decreased cardiac output or hypotension secondary to anesthesia, or decreased metabolic rate due to hypothermia. Although development of acute tolerance to barbiturates has been reported to occur in some species, including humans, this has not been demonstrated to be the case for rats regardless of dose rate or repetition of administration (Fragen and Avram, 2004; Harashima et al., 1997). Rats have been shown to develop acute tolerance to propofol when administered by infusion, especially in older animals (Larsson and Wahlstrom, 1996).

F. Effects of Strain, Sex, and Age

As different rodent strains and either sex may have variations in basic physiology, e.g., cardiovascular traits (Hoit et al., 2002), they may respond uniquely to various anesthetics, particularly injectable agents (Homanics et al., 1999; Koizumi et al., 2002; Sonner et al., 1999; Zambricki and Dalecy, 2004). This may be of particular importance when dealing with transgenic or targeted mutant strains that may have altered phenotypic responses that are undocumented. Similarly, caution should be used in chronic studies with repeated imaging of animals that may have aged considerably between sessions. Aged animals display altered physiology and altered responses to anesthetics (Chaves et al., 2003). Older animals often require drugs to be administered at reduced dose rates due to increased sensitivity; this is

another reason why, wherever possible, inhalational anesthesia is recommended. When presented with geriatric subjects that require *in vivo* imaging, one must be aware of their physiological limitations and reduced ability to deal appropriately with the stress of anesthesia, especially for long sessions.

IV. IMAGING-SPECIFIC CONSIDERATIONS

The unique environment of each imaging modality creates a variety of conditions that must be considered when planning an anesthetic protocol for *in vivo* imaging. As previously stated, the authors consider inhalational anesthesia to be the safest method of general anesthesia for small laboratory animals during any imaging procedure regardless of the acquisition time. In addition to the rapid induction and recovery, these agents can be rapidly and remotely adjusted, are not significantly metabolized, are safe for repeated use, and generally have the least adverse effects on physiological homeostasis when used appropriately. Precision equipment is needed to properly administer inhalational anesthetics, and a certain amount of ingenuity is often needed to tailor the equipment to each imaging situation.

The magnetic forces of MRI require that any equipment used in or around the magnet should be nonferrous and MRI compatible. One must ensure that any physiological monitoring devices used during an MRI procedure function in the MRI environment. Additionally, some monitoring accessories (e.g., ECG leads), although nonferrous and MRI-compatible, may create artifact in the final image. Despite this, it is important to utilize as many monitoring devices as possible to ensure the well-being of the animal, but monitoring must be balanced with the imaging protocol as well. It is particularly important to monitor animals while in the MR imager because the animal is often imaged at a distance from the anesthetist, and may not be visible or accessible during the procedure.

MicroCT and μ PET are similar in that the procedures may be relatively short (less than 1 hour) and, depending on the equipment, the animal may be visible for inspection during imaging. Although visible, animals will not be accessible without interrupting the image acquisition. As with MRI, it is important to maintain the animals' homeostasis as much as possible, but again, some monitoring devices are problematic within the imaging device. Circulating water blankets and disposable hand warmers severely impair μ CT images, but warming the inspired air close to the animal helps maintain its body temperature along with proper insulation during imaging (e.g., bubble or plastic wrap). ECG leads may cause image artifacts, while the respiratory balloon may cause tissue and organ distortion if inappropriately placed under the animal.

To facilitate optimal results during ultrasound or optical imaging, it is usually necessary to remove the animal's fur from the area of interest with depilatory creams. Fur is an important factor in maintaining an animal's core body temperature, and its

removal can result in hypothermia even in conscious animals. It is vital to provide heat during imaging procedures to minimize hypothermia. For ultrasound imaging, warmed coupling gel and use of a radiant heat lamp can help keep the animal warm during imaging. Some optical imaging devices include warmed imaging platforms, but often are not equipped to accommodate monitoring devices. Fortunately, optical imaging is rapid and animals need only be anesthetized for short periods of time. The need for heating of animals during the anesthesia recovery period cannot be stressed enough, particularly for those animals recovering from prolonged imaging sessions. Rembert et al. (2004) suggested that forced-air warming devices provide the most effective microenvironment for thermal support of anesthetized rodents and these devices can be manipulated or modified to be compatible with the imaging equipment.

MRI and CT scanners are expensive devices regardless of whether they are clinical or preclinical instruments. Other types of *in vivo* scanners such as ultrasound, PET, or optical imagers may also be difficult to procure with a small facility's budget. Therefore, it is common for investigators to use clinical scanners during the non-patient hours for their imaging studies. Furthermore, even dedicated preclinical scanners may be located remotely within a core facility, distant from the vivarium. Thus, in order to perform the study, remote scanner locations may require discretionary animal transportation over some distance through non-animal research areas. Depending on the resources available at the imaging site, it may be necessary to sedate or anesthetize the animal prior to transportation. This could greatly prolong the animal's entire anesthesia time, so careful thought and planning must occur to avoid anesthetic complications during transportation or imaging. As with any procedure, maintaining the animal's body temperature is critical and must be considered. Following is an example of one type of imaging anesthesia protocol that includes transportation: a NHP is sedated in its home facility with an intramuscular injection of a ketamine and medetomidine. Once appropriately relaxed, the animal is intubated and IV access achieved if needed. The animal remains sedated with additional ketamine if necessary during transportation in an appropriate institutionally approved container with supplemental heat. Upon arrival at the imaging center, anesthesia can be maintained with an inhalational agent such as isoflurane to enable preparation and imaging. Upon completion of the imaging study, the inhalational agent would be discontinued and before recovery the NHP would receive another injection of the ketamine and medetomidine cocktail for the return transportation.

V. ANESTHESIA

Selection of the anesthetic technique needs to balance the necessary requirements such as lack of motion, respiratory or cardiac gating, and minimal perturbation of normal physiology

against the ease of application, cost of associated equipment, and convenience.

A. Injectable Anesthesia

A variety of drugs are available for use as injectable anesthetic agents in small laboratory animals. For details of drug pharmacology and small animal anesthesia, the reader should refer to the appropriate chapters of this book. Choice of an injectable technique will depend in part on the imaging technique to be used and the likely duration of anesthesia necessary to acquire the appropriate images. One major goal for acquiring diagnostic images is to keep animals still for the duration of image/data acquisition, with minimal perturbation of their physiology. With genetically altered animals, or those being imaged postoperatively, consideration must be given to the possible increased response of these animals to the known side effects of anesthetics.

Drugs most commonly used by injection for imaging studies include TBE, ketamine and xylazine mixtures with or without acepromazine, ketamine and medetomidine mixtures, and pentobarbital. Many other injectable agents are available (e.g., propofol, alpha-chloralose), but the anesthetist should have experience and familiarity with the method chosen for an imaging protocol. One should consider the time needed for image acquisition and recovery. Additionally, the access restrictions often associated with common imaging modalities may prohibit the use of injectable anesthetics if the procedure is expected to take longer than 15–20 minutes. Due to the difficulties of vascular access in mice and rats, these drugs are most often delivered via IP or subcutaneous injection. It is usually impractical to administer a repeat IP injection during an imaging procedure. Vascular access is most commonly achieved by catheterization of a tail vein, generally in anesthetized animals, although access for a single injection is possible in both conscious rats and mice. In either case, this requires a skilled operator for success.

B. Inhalational Anesthesia

Animals undergoing longer studies using μ CT, ultrasound, PET, MRI, or SPECT are best anesthetized by inhalational techniques, in order to reduce the accumulation of principal drug or metabolites that occur with redosing of injectable agents. Inhalational anesthetics allow for rapid and remote adjustments to maintain the animal in an adequate plane of anesthesia. Similarly, for very short procedures lasting only a few minutes, inhalational anesthesia is often the most suitable method, because the animals are induced and recover rapidly with minimal to no side effects.

Isoflurane is the preferred inhalational agent for use with mice and rats, although halothane is still used. Newer more rapidly acting agents such as sevoflurane and desflurane are also suitable for use with small laboratory animals; however, at this

time they are considerably more expensive than either isoflurane or halothane, and neither provide considerably more utility in rodents than the older agents.

Gaseous anesthesia is generally administered via a nonrebreathing system, most often a variant on a Bain circuit with an outer expiratory “limb” and an inner fresh gas delivery mechanism. These are most appropriate for rodents due to their very small tidal volumes, which are no match for the one-way valves of standard rebreathing systems. Implicit in the successful use of such systems is the inclusion of a precision vaporizer for controlled anesthetic delivery.

In conclusion, although there are many possible approaches to anesthetize small laboratory rodents for *in vivo* imaging studies, the authors consider inhalational anesthesia, especially with isoflurane, to be the safest and most reliable method. Isoflurane minimizes physiologic and metabolic disturbances compared with injectable anesthetic drugs and combinations. The effect of isoflurane is titratable, an important consideration for lengthy procedures during which access to the animal may be extremely limited. As stated in the beginning of the chapter, genetically manipulated rodents are increasingly being used in research. In many instances, these animals are studied through application of new imaging techniques. Given the difficulties of vascular access and the increased physiological impacts of many injectable drugs, inhalational anesthesia is most frequently the preferred method to anesthetize these small species. For larger species, such as NHP, swine, and dogs, injectable techniques are generally more feasible, however the same caveats apply; access to the anesthetized animal is limited and the metabolic effects of some drugs may affect the imaging outcome. Despite this, use of injectable anesthetics may be unavoidable when dealing with some species, e.g., NHP and swine. In these situations, the reader is advised to consider the reason for imaging the animals by consultation with the researcher to ensure minimal influence on the study. Inhalant anesthesia overall provides the simplest and safest method and allows for ready and swift control of anesthetic depth. Multiple physiological systems should be monitored (as many as the experiment will allow) to enable the anesthetist to maintain the animal in a stable anesthetic depth with minimal perturbation of normal physiology. A major component of maintaining stable physiology is limiting the degree of hypothermia that can develop very rapidly in anesthetized small animals. Most of the considerations discussed above pertain to many of the newer imaging modalities available for the laboratory animal; and many studies require prolonged anesthesia while restricting subject access during image acquisition.

REFERENCES

- Abbey, C.K., Borowsky, A.D., McGoldrick, E.T., Gregg, J.P., Maglione, J.E., Cardiff, R.D., and Cherry, S.R. (2004). *In vivo* positron-emission tomography imaging of progression and transformation in a mouse model of mammary neoplasia. *Proc. Natl. Acad. Sci. U S A* **101**(31), 11438–11443.

- Akhter, M.P., Iwaniec, U.T., Covey, M.A., Cullen, D.M., Kimmel, D.B., and Recker, R.R. (2000). Genetic variations in bone density, histomorphometry, and strength in mice. *Calcif. Tissue Int.* **67**(4), 337–344.
- Balaban, R.S., and Hampshire, V.A. (2001). Challenges in small animal noninvasive imaging. *ILAR J.* **42**(3), 248–262.
- Ballou, B., Ernst, L.A., and Waggoner, A.S. (2005). Fluorescence imaging of tumors in vivo. *Curr. Med. Chem.* **12**(7), 795–805.
- Baudelet, C., and Gallez, B. (2004). Effect of anesthesia on the signal intensity in tumors using BOLD-MRI: Comparison with flow measurements by laser Doppler flowmetry and oxygen measurements by luminescence-based probes. *Magn. Reson. Imaging* **22**(7), 905–912.
- Brommage, R. (2003). Validation and calibration of DEXA body composition in mice. *Am. J. Physiol. Endocrinol. Metab.* **285**(3), E454–E459.
- Brown, R.H., Walters, D.M., Greenberg, R.S., and Mitzner, W. (1999). A method of endotracheal intubation and pulmonary functional assessment for repeated studies in mice. *J. Appl. Physiol.* **87**(6), 2362–2365.
- Budinger, T.F., Benaron, D.A., and Koretsky, A.P. (1999). Imaging transgenic animals. *Ann. Rev. Biomed. Eng.* **1**(1), 611.
- Cavanaugh, D., Johnson, E., Price, R.E., Kurie, J., Travis, E.L., and Cody, D.D. (2004). In vivo respiratory-gated micro-CT imaging in small-animal oncology models. *Mol. Imaging* **3**(1), 55–62.
- Chacko, V.P., Aresta, F., Chacko, S.M., and Weiss, R.G. (2000). MRI/MRS assessment of in vivo murine cardiac metabolism, morphology, and function at physiological heart rates. *Am. J. Physiol. Heart Circ. Physiol.* **279**(5), H2218–H2224.
- Chatham, J.C., and Blackband, S.J. (2001). Nuclear magnetic resonance spectroscopy and imaging in animal research. *ILAR J.* **42**(3), 189–208.
- Chaves, A.A., Dech, S.J., Nakayama, T., Hamlin, R.L., Bauer, J.A., and Carnes, C.A. (2003). Age and anesthetic effects on murine electrocardiography. *Life Sciences* **72**(21), 2401–2412.
- Cherry, S.R. (2004). In vivo molecular and genomic imaging: New challenges for imaging physics. *Phys. Med. Biol.* **49**(3), R13–R48.
- Cherry, S.R., and Gambhir, S.S. (2001). Use of positron emission tomography in animal research. *ILAR J.* **42**(3), 219–232.
- Chu, D.K., Jordan, M.C., Kim, J.K., Couto, M.A., and Roos, K.P. (2006). Comparing isoflurane with tribromoethanol anesthesia for echocardiographic phenotyping of transgenic mice. *J. Am. Assoc. Lab. Anim. Sci.* **45**(4), 8–13.
- Church, D.B., Nicholson, A.I., Ilkiw, J.E., and Emslie, D.R. (1994). Effect of non-adrenal illness, anaesthesia and surgery on plasma cortisol concentrations in dogs. *Res. Vet. Sci.* **56**(1), 129–131.
- Coatney, R.W. (2001). Ultrasound imaging: Principles and applications in rodent research. *ILAR J.* **42**(3), 233–247.
- Colby, L.A., and Morenko, B.J. (2004). Clinical considerations in rodent bioimaging. *Comp. Med.* **54**(6), 623–630.
- Contag, C.H., and Bachmann, M.H. (2002). Advances in in vivo bioluminescence imaging of gene expression. *Annu. Rev. Biomed. Eng.* **4**, 235–260.
- Dawson, D., Lygate, C.A., Saunders, J., Schneider, J.E., Ye, X., Hulbert, K., Noble, J.A., and Neubauer, S. (2004). Quantitative 3-dimensional echocardiography for accurate and rapid cardiac phenotype characterization in mice. *Circulation* **110**(12), 1632–1637.
- Diehl, K.H., Hull, R., Morton, D., Pfister, R., Rabemampianina, Y., Smith, D., Vidal, J.M., and van de Vorstenbosch, C. (2001). A good practice guide to the administration of substances and removal of blood, including routes and volumes. *J. Appl. Toxicol.* **21**(1), 15–23.
- Ford, N.L., Martin, E.L., Lewis, J.F., Veldhuizen, R.A., Drangova, M., and Holdsworth, D.W. (2007). In vivo characterization of lung morphology and function in anaesthetized free-breathing mice using non-invasive micro-computed tomography. *J. Appl. Physiol.* **102**, 2046–2055.
- Foster, F.S., Zhang, M.Y., Zhou, Y.Q., Liu, G., Mehi, J., Cherin, E., Harasiewicz, K.A., Starkoski, B.G., Zan, L., Knapik, D.A., and Adamson, S.L. (2002). A new ultrasound instrument for in vivo microimaging of mice. *Ultrasound Med. Biol.* **28**(9), 1165–1172.
- Fragen, R.J., and Avram, M.J. (2004). Barbiturates. In “Anesthesia.” (R.D. Miller, ed.), Vol. 1, pp 209–227. Churchill Livingstone, Philadelphia.
- Fueger, B.J., Czernin, J., Hildebrandt, I., Tran, C., Halpern, B.S., Stout, D., Phelps, M.E., and Weber, W.A. (2006). Impact of animal handling on the results of ¹⁸F-FDG PET studies in mice. *J. Nucl. Med.* **47**(6), 999–1006.
- Hama, Y., Urano, Y., Koyama, Y., Bernardo, M., Choyke, P.L., and Kobayashi, H. (2006). A comparison of the emission efficiency of four common green fluorescence dyes after internalization into cancer cells. *Bioconjug. Chem.* **17**(6), 1426–1431.
- Harashima, H., Ebling, W.F., Russell Wada, D., and Stanski, D.R. (1997). No effect of age on the dose requirement of thiopental in the rat. *Exp. Gerontol.* **32**(3), 315–324.
- Hart, C.Y.T., Burnett, J.C., Jr., and Redfield, M.M. (2001). Effects of avertin versus xylazine–ketamine anesthesia on cardiac function in normal mice. *Am. J. Physiol. Heart Circ. Physiol.* **281**(5), H1938–H1945.
- Hassan, M., and Klaunberg, B.A. (2004). Biomedical applications of fluorescence imaging in vivo. *Comp. Med.* **54**(6), 635–644.
- Hildebrandt, I.J., and Gambhir, S.S. (2004). Molecular imaging applications for immunology. *Clin. Immunol.* **111**(2), 210–224.
- Hoit, B.D., Kiatchosakun, S., Restivo, J., Kirkpatrick, D., Olszens, K., Shao, H., Pao, Y.H., and Nadeau, J.H. (2002). Naturally occurring variation in cardiovascular traits among inbred mouse strains. *Genomics* **79**(5), 679–685.
- Holdsworth, D.W., and Thornton, M.M. (2002). Micro-CT in small animal and specimen imaging. *Trends Biotechnol.* **20**(8), S34–S39.
- Homanics, G., Quinlan, J., and Firestone, L. (1999). Pharmacologic and behavioral responses of inbred C57BL/6J and strain 129/SvJ mouse lines. *Pharmacol. Biochem. Behav.* **63**(1), 21–26.
- Itoh, T., Wakahara, S., Nakano, T., Suzuki, K., Kobayashi, K., and Inoue, O. (2005). Effects of anesthesia upon ¹⁸F-FDG uptake in rhesus monkey brains. *Ann. Nucl. Med.* **19**(5), 373–377.
- Janssen, B.J.A., De Celle, T., Debets, J.J.M., Brouns, A.E., Callahan, M.F., and Smith, T.L. (2004). Effects of anesthetics on systemic hemodynamics in mice. *Am. J. Physiol. Heart Circ. Physiol.* **287**(4), H1618–H1624.
- Kawahara, Y., Tanonaka, K., Daicho, T., Nawa, M., Oikawa, R., Nasa, Y., and Takeo, S. (2005). Preferable anesthetic conditions for echocardiographic determination of murine cardiac function. *J. Pharmacol. Sci.* **99**(1), 95–104.
- Kiatchosakun, S., Kirkpatrick, D., and Hoit, B.D. (2001). Effects of tribromoethanol anesthesia on echocardiographic assessment of left ventricular function in mice. *Comp. Med.* **51**(1), 26–29.
- Kober, F., Iltis, I., Cozzone, P.J., and Bernard, M. (2004). Cine-MRI assessment of cardiac function in mice anesthetized with ketamine/xylazine and isoflurane. *Magma* **17**(3–6), 157–161.
- Koizumi, T., Maeda, H., and Hioki, K. (2002). Sleep-time variation for ethanol and the hypnotic drugs tribromoethanol, urethane, pentobarbital, and propofol within outbred ICR mice. *Exp. Anim.* **51**(2), 119–124.
- Kreissl, M.C., Wu, H.M., Stout, D.B., Ladno, W., Schindler, T.H., Zhang, X., Prior, J.O., Prins, M.L., Chatziioannou, A.F., Huang, S.C., and Schelbert, H.R. (2006). Noninvasive measurement of cardiovascular function in mice with high-temporal-resolution small-animal PET. *J. Nucl. Med.* **47**(6), 974–980.
- Larsson, J.E., and Wahlstrom, G. (1996). Age-dependent development of acute tolerance to propofol and its distribution in a pharmacokinetic compartment-independent rat model. *Acta Anaesthesiol. Scand.* **40**(6), 734–740.
- Lee, K.H., Ko, B.H., Paik, J.Y., Jung, K.H., Choe, Y.S., Choi, Y., and Kim, B.T. (2005). Effects of anesthetic agents and fasting duration on ¹⁸F-FDG biodistribution and insulin levels in tumor-bearing mice. *J. Nucl. Med.* **46**(9), 1531–1536.
- Lewis, J.S., Achilefu, S., Garbow, J.R., Laforest, R., and Welch, M.J. (2002). Small animal imaging: Current technology and perspectives for oncological imaging. *Eur. J. Cancer* **38**(16), 2173–2188.
- Lieggi, C.C., Artwohl, J.E., Leszczynski, J.K., Rodriguez, N.A., Fickbohm, B.L., and Fortman, J.D. (2005). Efficacy and safety of stored and newly prepared tribromoethanol in ICR mice. *Contemp. Top. Lab. Anim. Sci.* **44**(1), 17–22.
- Martiniova, L., Ohta, S., Guion, P., Schimel, D., Lai, E.W., Klaunberg, B., Jagoda, E., and Pacak, K. (2006). Anatomical and functional imaging of

- tumors in animal models: Focus on pheochromocytoma. *Ann. N. Y. Acad. Sci.* **1073**, 392–404.
- Massoud, T.F., and Gambhir, S.S. (2003). Molecular imaging in living subjects: Seeing fundamental biological processes in a new light. *Genes Dev.* **17**(5), 545–580.
- McConville, P., Moody, J.B., and Moffat, B.A. (2005). High-throughput magnetic resonance imaging in mice for phenotyping and therapeutic evaluation. *Curr. Opin. Chem. Biol.* **9**(4), 413–420.
- Mirsattari, S.M., Bihari, F., Leung, L.S., Menon, R.S., Wang, Z., Ives, J.R., and Bartha, R. (2005). Physiological monitoring of small animals during magnetic resonance imaging. *J. Neurosci. Methods* **144**(2), 207–213.
- Ntziachristos, V., Bremer, C., and Weissleder, R. (2003). Fluorescence imaging with near-infrared light: New technological advances that enable in vivo molecular imaging. *Eur. Radiol.* **13**(1), 195–208.
- Papaioannou, V.E., and Fox, J.G. (1993). Efficacy of tribromoethanol anesthesia in mice. *Lab. Anim. Sci.* **43**(2), 189–192.
- Paulus, M.J., Gleason, S.S., Easterly, M.E., and Foltz, C.J. (2001). A review of high-resolution X-ray computed tomography and other imaging modalities for small animal research. *Lab. Anim. (NY)* **30**(3), 36–45.
- Paulus, M.J., Gleason, S.S., Kennel, S.J., Hunsicker, P.R., and Johnson, D.K. (2000). High resolution X-ray computed tomography: An emerging tool for small animal cancer research. *Neoplasia* **2**(1–2), 62–70.
- Pautler, R.G. (2004). Mouse MRI: Concepts and applications in physiology. *Physiology (Bethesda)* **19**, 168–175.
- Pawson, P., and Forsyth, S. (2002). Anesthetic agents. In “*Small Animal Clinical Pharmacology*.” (J.E. Maddison, S.W. Page, and D. Church, eds.), pp 69–100. W.B. Saunders, London.
- Phoon, C.K.L., and Turnbull, D.H. (2003). Ultrasound biomicroscopy-Doppler in mouse cardiovascular development. *Physiol. Genomics* **14**(1), 3–15.
- Pomplun, D., Mohlig, M., Spranger, J., Pfeiffer, A.F., and Ristow, M. (2004). Elevation of blood glucose following anaesthetic treatment in C57BL/6 mice. *Horm. Metab. Res.* **36**(1), 67–69.
- Reid, W.C., Carmichael, K.P., Srinivas, S., and Bryant, J.L. (1999). Pathologic changes associated with use of tribromoethanol (avertin) in the Sprague-Dawley rat. *Lab. Anim. Sci.* **49**(6), 665–667.
- Rembert, M.S., Smith, J.A., and Hosgood, G. (2004). A comparison of a forced-air warming system to traditional thermal support for rodent microenvironments. *Lab. Anim.* **38**(1), 55–63.
- Ritman, E.L. (2005). Micro-computed tomography of the lungs and pulmonary-vascular system. *Proc. Am. Thorac. Soc.* **2**(6), 477–480, 501.
- Rivera, B., Miller, S., Brown, E., and Price, R. (2005). A novel method for endotracheal intubation of mice and rats used in imaging studies. *Contemp. Top. Lab. Anim. Sci.* **44**(2), 52–55.
- Roth, D.M., Swaney, J.S., Dalton, N.D., Gilpin, E.A., and Ross, J., Jr. (2002). Impact of anesthesia on cardiac function during echocardiography in mice. *Am. J. Physiol. Heart Circ. Physiol.* **282**(6), H2134–H2140.
- Ruff, J., Wiesmann, F., Lanz, T., and Haase, A. (2000). Magnetic resonance imaging of coronary arteries and heart valves in a living mouse: Techniques and preliminary results. *J. Magn. Reson.* **146**(2), 290–296.
- Sato, A., Klaunberg, B., and Tolwani, R. (2004). In vivo bioluminescence imaging. *Comp. Med.* **54**(6), 631–634.
- Schwarte, L.A., Zuurbier, C.J., and Ince, C. (2000). Mechanical ventilation of mice. *Basic Res. Cardiol.* **95**(6), 510–520.
- Semeniuk, L.M., Kryski, A.J., and Severson, D.L. (2002). Echocardiographic assessment of cardiac function in diabetic db/db and transgenic db/db-hGLUT4 mice. *Am. J. Physiol. Heart Circ. Physiol.* **283**(3), H976–H982.
- Shireman, P.K., and Quinones, M.P. (2005). Differential necrosis despite similar perfusion in mouse strains after ischemia. *J. Surg. Res.* **129**(2), 242–250.
- Sonner, J.M., Gong, D., Li, J., Eger, E.I., II, and Laster, M.J. (1999). Mouse strain modestly influences minimum alveolar anesthetic concentration and convulsivity of inhaled compounds. *Anesth. Analg.* **89**(4), 1030–1034.
- Soutiere, S.E., and Mitzner, W. (2004). On defining total lung capacity in the mouse. *J. Appl. Physiol.* **96**(5), 1658–1664.
- Strohl, K.P., Dick, T., and Baekey, D. (2005). “Calibration and Validation of the MouseOx™ Small-Animal Pulse Oximeter.” 3 pp. (Accessed from <http://www.starrlifesciences.com/starr/mouseoxwhitepaper.pdf>, January 12, 2006)
- Syed, F., Diwan, A., and Hahn, H.S. (2005). Murine echocardiography: A practical approach for phenotyping genetically manipulated and surgically modeled mice. *J. Am. Soc. Echocardiogr.* **18**(9), 982–990.
- Takuma, S., Suehiro, K., Cardinale, C., Hozumi, T., Yano, H., Shimizu, J., Mullis-Jansson, S., Sciacca, R., Wang, J., Burkhoff, D., Di Tullio, M.R., and Homma, S. (2001). Anesthetic inhibition in ischemic and nonischemic murine heart: Comparison with conscious echocardiographic approach. *Am. J. Physiol. Heart Circ. Physiol.* **280**(5), H2364–H2370.
- Thal, S.C., and Plesnila, N. (2007). Non-invasive intraoperative monitoring of blood pressure and arterial pCO₂ during surgical anesthesia in mice. *J. Neurosci. Methods* **159**(2), 261–267.
- Thompson, J.S., Brown, S.A., Khurdayan, V., Zeynalzadedan, A., Sullivan, P.G., and Scheff, S.W. (2002). Early effects of tribromoethanol, ketamine/xylazine, pentobarbital, and isoflurane anesthesia on hepatic and lymphoid tissue in ICR mice. *Comp. Med.* **52**(1), 63–67.
- Toyama, H., Ichise, M., Liow, J.S., Vines, D.C., Seneca, N.M., Modell, K.J., Seidel, J., Green, M.V., and Innis, R.B. (2004). Evaluation of anesthesia effects on [18F]FDG uptake in mouse brain and heart using small animal PET. *Nucl. Med. Biol.* **31**(2), 251–256.
- Vera, E.R., Battell, M.L., Bhanot, S., and McNeill, J.H. (2002). Effects of age and anesthetic on plasma glucose and insulin levels and insulin sensitivity in spontaneously hypertensive and Wistar rats. *Can. J. Physiol. Pharmacol.* **80**(10), 962.
- Wang, D.S., Dake, M.D., Park, J.M., and Kuo, M.D. (2006). Molecular imaging: A primer for interventionalists and imagers. *J. Vasc. Interv. Radiol.* **17**(9), 1405–1423.
- Weiss, J., and Zimmermann, F. (1999). Tribromoethanol (Avertin) as an anaesthetic in mice. *Lab. Anim.* **33**(2), 192–193.
- Weissleder, R. (2002). Scaling down imaging: Molecular imaging of cancer in mice. *Nat. Rev. Cancer* **2**(1), 11–18.
- Weissleder, R. (2006). Molecular imaging in cancer. *Science* **312**(5777), 1168–1171.
- Weissleder, R., and Mahmood, U. (2001). Molecular imaging. *Radiology* **219**(2), 316–333.
- Weissleder, R., and Ntziachristos, V. (2003). Shedding light onto live molecular targets. *Nat. Med.* **9**(1), 123–128.
- Winning, J., Huwer, H., Redjai, J., Naumann, C., Winning, I., Schneider, G., and Bauer, M. (2004). Noninvasive mechanical ventilation of mice by using a balloon-tipped cannula. *Contemp. Top. Lab. Anim. Sci.* **43**(6), 39–41 (quiz 58).
- Wirtzfeld, L.A., Wu, G., Bygrave, M., Yamasaki, Y., Sakai, H., Moussa, M., Izawa, J.I., Downey, D.B., Greenberg, N.M., Fenster, A., Xuan, J.W., and Laceyfield, J.C. (2005). A new three-dimensional ultrasound microimaging technology for preclinical studies using a transgenic prostate cancer mouse model. *Cancer Res.* **65**(14), 6337–6345.
- Yang, X.-P., Liu, Y.-H., Rhaleb, N.-E., Kurihara, N., Kim, H.E., and Carretero, O.A. (1999). Echocardiographic assessment of cardiac function in conscious and anesthetized mice. *Am. J. Physiol. Heart Circ. Physiol.* **277**(5), H1967–H1974.
- Zambricki, E.A., and Dalecy, L.G. (2004). Rat sex differences in anesthesia. *Comp. Med.* **54**(1), 49–53.
- Zeller, W., Meier, G., Burki, K., and Panoussis, B. (1998). Adverse effects of tribromoethanol as used in the production of transgenic mice. *Lab. Anim.* **32**(4), 407–413.
- Zhou, Y.Q., Foster, F.S., Nieman, B.J., Davidson, L., Chen, X.J., and Henkelman, R.M. (2004). Comprehensive transthoracic cardiac imaging in mice using ultrasound biomicroscopy with anatomical confirmation by magnetic resonance imaging. *Physiol. Genomics* **18**(2), 232–244.
- Zhou, Y.Q., Foster, F.S., Qu, D.W., Zhang, M., Harasiewicz, K.A., and Adamson, S.L. (2002). Applications for multifrequency ultrasound biomicroscopy in mice from implantation to adulthood. *Physiol. Genomics* **10**(2), 113–126.
- Zuurbier, C.J., Emons, V.M., and Ince, C. (2002). Hemodynamics of anesthetized ventilated mouse models: Aspects of anesthetics, fluid support, and strain. *Am. J. Physiol. Heart Circ. Physiol.* **282**(6), H2099–H2105.

This page intentionally left blank

Index

A

- Abalones, 536
- Abdominal constriction test, 553
- A β fibers, 6
- Absorber systems, 134–135
- Acclimation, 620
- Acepromazine, 54, 55, 393–394
- cats, 370–371, 380
- dogs, 380
- for ferrets, 445
- rabbits, 301, 305
- rodents, 263
- Acetaminophen, 105
- primates, 358
- rabbits, 326
- rodents, 272
- Acetic acid derivatives, 105–106
- Acid-sensing ion channels (ASIC), 6
- Acoustic signals detection, 220
- ACTH. *See* Adrenocorticotrophic hormone (ACTH)
- Activated clotting time (ACT), 428
- Active scavenging, 140
- Activity-dependent glial model, 12–13
- Activity-dependent neuronal model, 12, 13
- Acupuncture, 626–627
- Acute pain, 4, 200
- Adaptors, endotracheal tube, 164
- Adenosine, 46, 595
- A δ fibers, 6
- Adjustable pressure-limiting valve, 135
- Adrenal steroidogenesis, inhibition by imidazoles, 38
- α 2-adrenergic agonists, 115–117, 305, 326.
- See also*
- Medetomidine; Xylazine
- administration routes and preparations, 117
- antagonists, 118
- history of, 115
- mechanism of action, 116
- pharmacokinetics and metabolism, 117
- rodents, 274–275
- side effects, 116–117
- therapeutic activities, 116–117
- Adrenocorticotrophic hormone (ACTH), 197
- Adynamic ileus, 36
- Age differences, 556
- Agonist–antagonist, 114
- Air sacs, in birds, 484
- Air sampling
- continuous. *See* Infrared spectrophotometry.
- instantaneous, 189
- Airway
- access and control equipment for, 159–167
- assessment at perioperative period, 228
- obstruction, 380
- Alanine aminotransferase (ALT), plasma, 418, 419
- Alkanones, 108
- Allometric scaling, 29
- Allopregnanolone, 596
- Alpha-2 adrenoreceptor agonists, 50–54
- for foetuses, 599
- Alpha-agonists, 228
- Alpha-2 agonists
- in fish, 529
- for ruminants, 390–393, 407–408
- Alpha chloralose, 36–37
- with ketamine, 66
- rabbits, 311
- rodents, 265
- in swines, 422
- Alphadolone, 43–44. *See also*
- Alphaxalone–alphadolone
- Alphaxalone, 43–44. *See also*
- Alphaxalone–alphadolone
- Alphaxalone–alphadolone
- in fish, 529–530
- primates, 345
- rabbits, 315
- rodents, 266
- Althesin, 43
- Alveolar dead space, 142
- ALZET[®] osmotic pumps, 232
- American Veterinary Medical Association (AVMA), 562
- euthanasia, 571
- Aminoamides, 61
- Aminoesters, 61
- 4-aminopyridine, rodents, 264
- Amitriptyline, for chronic pain, 586
- AMPA receptors, 9
- Amphibians
- anatomical considerations of, 512
- anesthetic induction in, 516
- anesthetic techniques, 513–514
- field anesthesia, 517
- immersion anesthesia, 514–515
- injectable anesthesia, 516
- larval anesthesia, 517
- volatile anesthesia, 515
- body temperature of, 511
- morphine in, 517
- mucous glands in, 512
- pain management in, 517
- physical restraint and handling of, 514
- preanesthesia in, 516
- preanesthetic evaluation and preparation of, 513
- recovery from anesthesia, 516–517
- routes of drug administration, 514
- skin of, 512
- tricaine methanesulfonate (MS-222) in, 514
- Anabolic Steroids Control Act of 1990, 575
- Anaesthetics, 598
- Analgesia. *See also* Analgesics
- cats, 377–380
- definition, 28
- dogs, 377–380

- Analgesia. *See also* Analgesics (*Contd.*)
 primates, 358–359
 rabbits, 324–327
 rodents, 264–265
 for ruminants
 alpha2 agonists, 407–408
 ketamine, 408
 lidocaine, 408
 NSAID, 408
 opioids, 408
- Analgesic–antipyretic drugs, 99–109
 classes of, 99
 history of, 100
 mechanism of action, 100–102
 side effects of, 102–103
 therapeutic activities of, 102–103
- Analgesics, 598, 619
 in amphibians, 517
 anorexia, 231
 buprenorphine, 610
 delivery of, 611
 dosages for ferrets, 453
 in fish, 531
 for hedgehogs (insectivores), 462
 in invertebrates, 542
 liposomal formulations of, 613–614
 loaded into pellets, 612–613
 NSAID, 610
 opioid, 197, 199, 609
 post-operative, 198
 for prairie dogs, 469
 in reptiles, 508
 for small marsupials, 461
 used in swines, 423
- Analgesiometric assays, 98
- Analgesiometry, 212
 rabbits, 324
- Anatomic dead space, 142
- Anesthesia
 for husbandry procedures, 404–405
 machines, 145–151
 human, 148–150
 maintenance and testing, 150–151
 rodent, 146–147
 used, 150
 monitoring of, 171–181
 on saliva secretion, 386
 workstations, 148–150
- Anesthetics, 171, 172–174, 387
 administration in ferrets, 444
 of amphibians, 516
 in arachnida, 540
 assessment for swines, 424
 combinations, 64–67
 considerations for animals during
 imaging
 cardiovascular function, 634
 hydration and metabolic status,
 634–635
 ventilation, 633–634
 for CPB in swines, 430–431
 doses used for birds, 482
 injectable, 158–159
 machines, 145–151, 187
 components, 130–141
 monitoring in ferrets, 452–453
 protocol for imaging, 636
 of reptiles, 507
 for ruminants, 398
 alpha2 agonists, 390–393
 benzodiazepines, 394
 opioids, 394–395
 pentobarbital, 395
 phenothiazine, 393–394
 safety issues, 576
 selection, 444
 used for fish, 523–531
- Anesthetized ruminant monitoring
 anesthetic agent concentration, 407
 body temperature, 407
 cardiovascular function, 406
 depth of anesthesia, 405–406
 fluid administration, 407
 respiratory function, 406
 ventilation support, 407
- Animal and Plant Inspection Service
 (APHIS)
 Administrator, 566
- Animal care programs
 experimental animal model, 224
 postprocedural planning, 224–225
 scheduling, 226
 training requirements, 225
- Animal killing, 565–566
- Animal Welfare Act, 224, 570–571
- Animal Welfare Information Center
 (AWIC), 563
- Animal welfare regulations
 in Canada, 577
 in Europe, 577–578
 European Economic Communities, 578
 United Kingdom, 577–578
 in other parts of the world, 578–579
 in US, 570–577
- Annelids, 538–539
- Anorexia, by analgesics, 231
- Antiarrhythmic drugs, 228
- Antibiotics, 231
 rabbits, 306
 rodents, 249
- Anticholinergic agents
 cats, 371–372
 dogs, 371–372
 in swines, 420
 used in ferrets, 447
- Anticoagulation, 428
- Anti-inflammatory drugs, 99–109
 classes of, 99
 history of, 100
 mechanism of action, 100–102
 side effects of, 102–103
 therapeutic activities of, 102–103
- Antinociception
 descending, 8
 role of alpha2-autoreceptors, 51
 serotonin and norepinephrine role in, 9
- APFR. *See* Arterial pump flow rates (APFR)
- Arachnids, 539–540
- Arbitrary words, meanings of, 211
- Armillos, 471–472
- Arrhythmias
 in birds, 494
 cats, 374
 dogs, 374
 in ferrets, 449
 primates, 340, 350
 in swines, 424
- Arterial blood pressure
 in cardiovascular system monitoring, 176
 of ferrets, 452
- Arterial pump flow rates (APFR), 428
- Arthritis
 adjuvant-induced, 554
 effect on ketoprofen metabolism, 107
- Ascending bellows. *See* Standing bellows
- Aspercreme, 614
- Asphyxia, 533
- Aspirin
 rabbits, 326
 rodents, 272
 routes of administration, 104
- Atipamezole, 53, 54
 cats, 371
 dogs, 371
 primates, 343
- ATP-gated ion channels, 6
- Atracurium, 267
 in birds, 495
- AtrE. *See* Atropinesterase (AtrE)
- Atropine
 cats, 371
 dogs, 372
 primates, 339
 rodents, 257, 266
- Atropinesterase (AtrE), 301
- Auricular vein, of ruminants, 390
- Australian giant crab, 540–541
- Autoclaves, 220
- Avertin, 42, 260–261
- Avinza, 612
- Azaperone, 55–56
 in fish, 530
 used in swines, 419

- B**
- Bain adaptor, 144–145
- Balanced anesthesia
cats, 369
dogs, 369
primates, 350, 356
- Baralyme, 92
- Barbiturates, 28
in amphibians, 516
antagonists, 35
cats, 372
dogs, 372
in fish, 530
as GABA agonists, 29, 30–35
pharmacologic effects of, 34–35
primates, 346
rabbits, 310–312
rodents, 259
used in swines, 421
- Bedding, 221
- Behavioral assessment approaches, 207
- Bellows ventilators, 152–153
- Benzocaine
in amphibians, 515
in fish, 526–527
immersion in fish, 63
- Benzodiazepines, 44–47
antagonists, 47
biodisposition, 45
cats, 371
diazepam, 394
dogs, 371
GABA agonists, 29
immune system effects, 46–47
midazolam, 394
pharmacologic effects, 45–46
primates, 343
used in swines, 419
zolazepam, 394
- Bettongia gaimardi*, 459
- Biodisposition
benzodiazepine derivatives, 45
chloral hydrate, 35–36
chloralose, 36
detomidine, 53
eugenol, 59
local anesthetics, 61–62
medetomidine, 52–53
metomidate and etomidate, 37–38
propofol, 39–40
steroids, 44
tribromoethanol (TBE), 42
urethane, 56–57
xylazine, 52
- BioLITE system, 161–162
- Bioluminescence, 631
- BioTex machine, 157, 158
- Birds
atracurium in, 495
breathing circuits in, 493
cardiac arrhythmias, 494
cardiovascular system of, 488–489
control of respiratory system in, 488
euthanasia of, 496
fasting of, 489–490
fresh gas flows in, 493
gas exchange in, 486–488
halothane in, 494
inhalational anesthetics in, 493
MAC for, 494
injectable anesthetics in, 490–493
diazepam, 491
equithesin, 492
injection sites for, 490
kappa opioids, 493
ketamine, 491
local anesthetics, 492
medetomidine, 491
midazolam, 491
NSAID, 493
pharmacologic considerations for, 490
phenobarbital, 492
propofol, 491–492
xylazine, 491
isoflurane in, 394–395
methods for inducing anesthesia in,
493–494
monitoring during anesthesia, 495–496
muscle paralytics in, 495
nitrous oxide in, 494–495
pain in, 492–493
physical examination before anesthesia,
489
physical restraint and handling of, 489
recovery of, 496
sevoflurane, 494
ventilation components of, 483–486
air sacs, 484
and anesthetic considerations, 485–486
bronchus, 484
larynx, 483
syrinx, 484
trachea, 483–484
- Bivalves, 538
- Black box warning*, 55
- Blades, laryngoscope, 159–160
- Blind intubation, 160
- Blood
collection
of armadillos, 472
of bats, 473
of insectivores, 462
gases
ketamine effects on, 49
monitoring, 228
pentobarbital effects on, 33
in primates, 351
in respiratory system monitoring, 178
glucose
during anaesthesia, 604
ketamine effects on, 49
urethane effects on, 58
renal, 602
transfusion, 229
- Blood/gas partition coefficient, 88
- Blood pH, monitoring, 228
- Blood pressure, 602
monitoring, 229
- Blood work, 444
- Body Temperature, during anaesthesia,
603–604
- Body weight, pain and, 208
- Boiling point, 88
- Bone tumor pain, treatment, 210
- Brain
foetal, 595, 596
sensitivity to propofol, 39
- Brainstem, projection from spinal cord to,
6–7
- Breathing circuits, 141–145
in birds, 493
- Breathing system manometer, 136
- Breathing valves, 135
- Bretyllium, 424
- Bronchus, in birds, 484
tertiary, 486
- Bupivacaine
cats, 379, 381
dogs, 379, 381
in reptiles, 506
- Buprenorphine, 114–115
cats, 378
dogs, 378
in ferrets, 447
primates, 359
for reducing tumor metastasis, 198
rodents, 264
used in swines, 423
- Burrowing, 221
- Butorphanol, 114. *See also* Opioids
in amphibians, 517
cats, 378
dogs, 378
doses for ferrets, 447
for fish, 531
primates, 359
sedative combination used in ferrets,
447–448
- Butyrophenones, 54, 55–56
used in swines, 419–420
- C**
- Caenorhabditis elegans*, 541
- Cage card tags, 227, 231

- Cage enrichments, for rodents, 221
- Calcium channel blockers, for chronic pain, 585–586
- Caloric requirements, 231
- Canada, 577
- Cancer, and occupational exposure to WAG, 186–187
- Cancer-associated chronic pain, 16
- Capillary refill time (CRT)
in cardiovascular system monitoring, 175
of ferrets, 452
- Capnography, in respiratory system monitoring, 178
- Carbon dioxide
rodents, 256
used in fish, 528, 532
- Cardiac anesthetic index, 91
- Cardiac output, in cardiovascular system monitoring, 176–177
- Cardiopulmonary bypass (CPB), 426–431
anesthesia for, 430–431
for malignant hyperthermia (MH) free swines, 430
for malignant hyperthermia (MH) positive swines, 430–431
and anticoagulation, 428
APFR in swines, 428
and CVP in normothermic-anesthetized swine, 429
description of, 427
Left atrial pressure measurement, 429
myocardial protection of swines during, 428
PCWP measurement, 429
physiological parameters in, 428–429
priming solutions for porcine, 427
termination of, 429–430
- Cardiovascular effects
from pain, 11
from urethane, 57–58
- Cardiovascular system
in birds, 488–489
monitoring, 174–177
toxicity with local anesthetics, 62
- Carnivora, 473–475
grizzly/brown bear, 473–474
spotted hyena, 474–475
- Carprofen, 106–107
in rabbits, 326
- Casting harness, 389
- Castration, of ruminants, 405
- Catecholamines, 228
- Catheterization
cats, 367
dogs, 367
rabbits, 306–307
urinary
in primates, female, 352
vascular
primates, 338
- Catheters, 616
butterfly, 231, 232
indwelling, 230
placement in ferrets, 444
- Cats
alphaxalone/alphadolone for, 44
analgesia, 377–380
anesthetic agents
acepromazine, 370–371, 380
antagonists of, 371
barbiturates, 372
inhalants, 374
ketamine, 380
propofol, 372
Telazol, 373
anesthetic management
cesarean section, 382
injection methods, 368
monitoring, 375–376
premedication, 371, 377
“Ceiling effect,” 29, 98
- Celecoxib, 109
- Central nervous system (CNS), 179–180
toxicity with local anesthetics, 62
- Central sensitization, 12–14
- Central supply connections, 131, 132
- Central venous pressure (CVP), 429
in cardiovascular system monitoring, 176
in primates, 351
- Cephalic vein, 415
- Cephalopods, 537
- Cesarean section
cats, 382
dogs, 382
- C fibers, 6
- C-fos gene expressions, 213
- Chamber anesthesia
carbon dioxide, rodents, 256
cats, 373
dogs, 373
- Charcoal filters, 189
- Chemical assays, 553–554
- Chemical restraint
of armadillos, 472
of bats, 473
to chinchillas, 470
of gray mouse lemur, 475
grizzly bear, 474
to ground squirrels, 467
of insectivores, 462
of lagomorpha, 471
of marsupials, 459
prairie dogs, 468
of rodents, 466
of spotted hyena, 474–475
to woodchuck, 468
- Chemotherapeutic neuropathic pain models, 555–556
- Chinchillas, 469–470
- Chiroptera. *See* Bats
- Chloral hydrate, 35–36
recommendation for fish, 528
rodents, 266
in scallops, 538
- Chloralose, 36–37
with lipopolysaccharide (LPS)
administration, 66
- Chloramphenicol, 30
- Chlorbutanol
to anesthetize amphibians, 515
recommendation for fish, 515
- Chlorpromazine, in rabbits, 305
- Choi double-angle blade, 159
- Chronic inflammatory pain, 16
- Chronic pain, 4, 200
characterization of, 581–582
definition of, 581–582
diagnosis of, 583–585
impact on research, 582–583
pathophysiology of, 14–16
prevalence of, 582
treatment of, 585–588
- Circadian effects, 556–557
- Circle systems, 142–143
- Climazolam, 46
- Clinical pain, 4
- Clips, for skin closure, 231
- Clonidine, 117
- Closed interface scavenging systems, 140, 141
- Clove oil
in abalones, 536
in amphibians, 515
- CMS. *See* Composite measurement scale (CMS)
- CNS. *See* Central nervous system (CNS)
- Codeine, 112–113, 611
- Cold stimuli, 552
- Cole endotracheal tubes, 163
- Collagen synthesis, inhibition by local anesthetics, 63
- Collars, Elizabethan, 222, 323
- Colloidal solutions, 230
- Common gas outlet, 134
- Compac5, 147, 148
- Composite measurement scale (CMS), 211
- Compressed gases, delivery of, 128–130
- Conduction block, 61
- γ -conotoxins, synthetic, 15
- Controlled Substances Act, Title 21 CFR, 573–575
- Conventional endotracheal tubes, 162–164

- Conventional laryngoscopes, 159–160
 Cortex, projection from thalamus to, 7–8
 Corticosteroids
 in rabbits, 326
 for treatment of chronic pain, 587
 Corticotropin-releasing factor (CRF), 197
 COX enzyme, 100
 inhibitors, 109
 relative selectivity of inhibitors of, 101, 102
 role in pain perception in CNS, 100, 103
 CPB. *See* Cardiopulmonary bypass (CPB)
 Craniotomy pain, 202
 Crayfish, 540
 Cremophor, 39
 Cremophor EL, 316
 CRF. *See* Corticotropin-releasing factor (CRF)
Crocota crocuta, 474–475
 Crustaceans, 540–541
Cryptotis parva, 461
 Cuffed endotracheal tubes, 162, 163
 Curved laryngoscope blades, 159, 160
 CVP. *See* Central venous pressure (CVP)
 CWE SAR-830/P ventilator, 154, 155
 Cyanosis, 177
 Cyclohexamines, 47–50
 biodisposition, 48
 pharmacologic effects, 48–50
 Cylinders, 128–130
 identification and markings, 129
 safety precautions, 130
Cynomys ludovicianus, 467–468
- D**
- Dam, 598
 Dantrolene
 for prevention of malignant hyperthermia (MH), 426
 Darts, for injection
 primates, 338
 Datex Capnomac PB254^B infrared analyzer, 93
 DEA. *See* Drug Enforcement Agency (DEA)
 Dead space, 142
 DEA Form 41, 575
 DEA Form 106, 575
 DEA Form 222, 575
 DEA Form 224, 574
 Decapitation, of fish, 532–533
 Dehorning, of ruminants, 404–405
 Department of Health and Human Services (DHHS), 574
 Depth of anesthesia, 171, 172–174
 cats, 375
 dogs, 375
 primates, 352
 rodents, 252
- Deracoxib, 109
 Descending bellows. *See* Hanging bellows
 Descriptive ethics, 562
 Desflurane, 92
 boiling point, 88
 and plasma fluoride concentration, 419
 rabbits, 309
 rodents, 255
 in swines, 418–419
 vaporizer, 139
 Detomidine, 53, 116, 117
 rabbits, 305
 Dexmedetomidine, subcutaneous dose of, 116
 Diabetic models, 230
 Diazepam, 45, 46, 394
 in birds, 491
 cats, 371
 dogs, 371
 in ferrets, 445
 in fish, 530
 with ketamine, 66
 primates, 343
 rabbits, 305
 rodents, 263
 in swines, 419
 Diclofenac, 106
Didelphis virginiana, 458
 Diethyl ether, recommendation for fish, 528
 Diflunisal, 104
 Dimethyl sulfoxide (DMSO), for
 veterinary use, 614
 Dipalmitoyl phosphatidylcholine (DPPC), 613
Dipodomys, 463
 Disbudding, of ruminants, 404–405
 Discharge tubing, 189
 Disposed Optimax Elite, 148, 149
 “Dissociative,” 47
 Dissociative agents, in swines, 420–421
 Distress, 565
 reporting in USDA Categories, 564–565
- Dogs
- analgesia, 377–380
 - anesthetic agents
 - acepromazine, 370–371, 380
 - antagonists of, 371
 - barbiturates, 372
 - inhalants, 374
 - ketamine, 380
 - propofol, 372
 - Telazol, 373
 - anesthetic management
 - cesarean section, 382
 - injection methods, 368
 - monitoring, 375–376
 - premedication, 371, 377
 - pentobarbital effects, 33
- Dopamine, interoperative, in primates, 353
 Dopaminergic receptor antagonists, 54–56
 Doppler ultrasound probe
 of birds, 496
 of ferrets, 452
 of reptiles, 508
 Dorsal horn projection neurons (DHPN), 6–7
 Dosimeters, 189
 Dräger Vapor 19.1 Vaporizer, 138
 Drawers, 223
 Droperidol, 55
 Drug abuse regulations and issues, 576–577
 Drug administration
 intramuscularly, 390
 intravenously, 390
 Drug delivery, intraperitoneal, 233
 Drug Enforcement Agency (DEA), 573–575
 Drug enforcement regulations and policies, 573–576
 Drug Schedules (Title 21 CFR Appendix), 575
 Drug selection, 602–603
 Dual circuit, 152
 Dual-energy x-ray absorptiometry, 630
 Dysesthesias, 200
- E**
- ECG (electrocardiogram) monitors and defibrillators, 223
 Echinoderms, 542
 Echocardiography, 631
 Education
 as strategy to control pain, 620
 for WAG-exposed personnels, 191
 EEG. *See* Electroencephalogram (EEG)
 Electrical silence, 596
 Electroanalgesia, 625–626
 Electroanesthesia, of fish, 531–532
 Electrocardiography (ECG)
 of birds, 489, 496
 in cardiovascular system monitoring, 175–176
 of ferrets, 452
 of fish, 523
 of reptiles, 508
 of swines, 424
 Electroencephalogram (EEG)
 activity, 595, 596
 foetal, 595, 596
 Electroencephalographic activity, 595
 Electronic flow control, 133–134
 EMLA. *See* Eutectic mixture of local anesthetics (EMLA)
 EMTU. *See* Ethyl-malonyl-thiourea (EMTU)

- Endotracheal intubation
 in ferrets, 444–445
 in reptiles, 505
 in ruminants, 398
 in swines, 416–417
- Endotracheal tubes, 162–166
 cats, 368–369
 dogs, 368–369
 rodent, 166
 rodents, 250
- End-tidal anesthetic concentration, in respiratory system monitoring, 178–179
- End-tidal CO₂ (ET_{CO₂})
 and malignant hyperthermia (MH), 425
 measurement in ferrets, 452
- Enflurane, 92
 rodents, 255
- Environmental enrichment, 621
- Epidural anaesthesia, 600
- Epidural analgesia, 600
 cats, 378, 379
 dogs, 378, 379
- Epidural anesthesia, in ruminants, 401–402
- Epidural injections, in ruminants, 402
- Epiglottis, 416
- Epinephrine, with local anesthetics, 61–62
- Equithesin
 in birds, 492
 in rabbits, 305, 311
- ESOX implantable pump, 232
- E Tanks, 128–129
- Ether, 86
 as inhaled anesthetic, 90–91
 rodents, 266
- Ethical issues, 561–567
 and distress, 565
 reporting in USDA Categories, 564–565
 and IACUC veterinarians role, 567
 and killing animals, 565–566
 and ratio of pain with number of animals, 566–567
 and reporting pain in USDA Categories, 564–565
 standard of care, 567
 Tannenbaum's classification of, 562–564
 and withholding pain management, 564
- Ethyl-malonyl-thiourea (EMTU), 311–312
- Etodolac, 106
- Etomidate, 37–38
 cats, 372–373
 dogs, 372–373
 primates, 347
 used as sedative in swines, 422
- Eugenol, 59–60
 in fish, 526
- Europe, 577–578
- European Economic Communities (EEC), 578
- Eutectic mixture of local anesthetics (EMLA), 63
 cream, 265
- Euthanasia, 372
 of birds, 496
 of fish, 532–533
 of invertebrates, 542–543
- Exchangers, endotracheal tube, 166–167
- Excitatory neurotransmitters, 9
- Experimental animal model, 224
- Expiratory phase time, 151
- External jugular veins, 415
- F**
- Face masks, 156–158, 187
- Facilitation, 8
- Fasting
 birds, 489–490
 primates, 337
 rabbits, 301
 rodents, 249
- Feeding behavior, pain and, 208
- Female gender, pain thresholds in, 5
- Fenamates, 106
- Fentanyl, 113, 612
 cats, 375
 dogs, 375
 in ferrets, 447
 for opioid infusion in swine, 421–422
 primates, 346–347, 356
 rodents, 261
- Fentanyl citrate, for rodents, 263–264
- Fentanyl-droperidol, in swines, 422
- Fentanyl-fluanisone, 64
- Fermentation, in rumen, 387
- Ferrets
 administration of anesthetic agents in, 444
 cardiac arrhythmias in, 449
 catheter placement in, 444
 endotracheal intubation in, 444–445
 fasting before anesthesia, 489–490
 inhalational anesthetics in, 450–452
 injectable anesthetics in, 449–450
 ketamine combinations in, 448–449
 LRS in dehydrated, 444
 monitoring methods used for anesthesia in, 452–453
 neonatal anesthesia, 454
 NSAID used for, 454
 pain management in, 453–454
 physical restraint to, 444
 preanesthesia in, 445–449
 acepromazine, 445
 diazepam, 445
 dissociative injectable combinations, 448–449
 medetomidine, 446–447
 midazolam, 445–446
 neuroleptic sedative combinations, 447–448
 neuromuscular blocking agents, 449
 opioids, 447
 xylazine, 446–447
 preanesthetic considerations for, 444
 prolonged anesthesia in, 454
 propofol in, 450
 telazol combinations in, 449–450
 ventilation efficiency of anesthetized, 452
- Fetus, in primates, 356
- FHCs. *See* Fluorinated hydrocarbons (FHCs)
- Field block, 61
- Firocoxib, 109
- Fish
 analgesic agents for, 531
 anesthetic agents for, 523–531
 immersion agents, 523–529
 injectable agents, 529–531
 electroanesthesia of, 531–532
 euthanasia of, 532–533
 evaluation of pain in, 520
 handling of, 521
 hypothermia in, 531
 injection sites in, 522
 local anesthetic immersion in, 63
 metomidate effects in, 37
 monitoring fish during anesthesia, 522–523
 NSAID in, 531
 opioids in, 531
 physical restraint of, 520–521
 principles of anesthesia in, 521–522
 regional anesthesia in, 531
 routes of drug administration, 521–522
 stages of anesthesia in, 522
- Flexible fiberoptic laryngoscopes, 160
- “Floppy infant syndrome,” 46
- Flotec oxygen flowmeter, 133
- Flowmeters, 132–134
- Flow Restrictors, 133
 rodent anesthesia machines, 147
- Fluanisone, 56
- Fluid therapy
 cats, 378–379
 dogs, 378–379
 in marsupials, 459
- Flumazenil, 47
- Flunixin, 107–108
 meglumine, 108
 rodents, 274
- Fluorescence, 631
- Fluorescent lights, and ICUs, 220
- Fluorinated hydrocarbons (FHCs), 189

- Fluovac Gas Scavenger, 157, 158
 Flush valve, oxygen, 134
 Foetal anaesthesia, 594, 600
 Foetal analgesia, 594, 600
 Foetal brain, 595, 596
 Foetal consciousness, 594, 596
 Foetal hypoxia, 600
 Foetal prostaglandin synthesis, 600
 Foetal stress responses, 597, 600
 Foetal synaptic circuits, 595
 Foetus
 alpha₂ adrenoreceptor agonists for, 599
 human, 594, 595
 inhalational agents for, 599
 ketamine for, 599
 mammalian, 595
 NSAID for, 600
 opioids for, 600
 propofol for, 599
 thiopental for, 599
 unconsciousness in, 596
 Formalin immersion, of live fish, 533
 Formalin test, 553
 Fresh gas flows, in birds, 493
- G**
- Gallamine, 267
 Gallamine triethiodide, in fish, 530–531
 Gamma-amino-butyric acid (GABA), 9
 agonists, 29–47
 mechanism of action, 29–30
 Gas chromatography, 94
 Gaseous anesthetic
 from vaporization of liquid anesthetic,
 85–86
 Gas exchange, in birds, 486–488
 Gas supply pressure gauges, 132
 Gastropods, 536–537
 Gating
 cardiac, 633
 respiratory, 633
 General anesthesia, defined, 86
 Genetically engineered rodents, 225
Geomys, 463
 Gerbils, 281
 Glial activation, chronic pain, 14
 Glial model, activity-dependent, 12–13
 Glottis
 of amphibians, 512
 of reptiles, 502
 “Glucose effect,” 31
 Glucose transporter, barbiturate inhibition
 of, 30–31
 Glutamate, 9
 Glycine, 9
 Glycopyrrolate
 cats, 371
 dogs, 371
 primates, 340
 rabbits, 301
 Gray mouse lemur, 475
 Grizzly/brown bear, 473–474
 Guinea pigs
 analgesic therapy, 280
 anatomical features, 279
 anesthetic agents, 280
 depth of anesthesia, 280
 species, 279
- H**
- Hallowell EMCAesthesiaWorkstation, 153
 Hallowell MicroVent1, 155
 Hallowell RodentWorkStand, 161
 Halogenated agents, hepatocellular injury
 caused by, 186
 Halothane, 91, 599
 in birds, 494
 cats, 374
 dogs, 374
 versus isoflurane, 418
 primates, 349
 rabbits, 318
 recommendation for fish, 528–529
 in reptiles, 506
 rodents, 253
 Hamsters, 280–281
 Handling
 of amphibians, 514
 of birds, 489
 of fish, 521
 of reptiles, 503
 Hanging bellows, 152, 153
 Harvard Apparatus 683 Small Animal
 Ventilator, 154
 Hay nets, 222
 Health Research Extension Act of 1985, 571
 Heart rate
 in cardiovascular system monitoring, 175
 pentobarbital, 33
 variability, 212
 Heating, of animals
 cats, 376
 dogs, 376
 rabbits, 322
 rodents, 279
 Heat lamps, 228
 Hematocrit, effect of urethane, 58
 Hemorrhage, postoperative, 376, 377, 380
 Hemostasis, 229
 Hepatitis, halothane, 186
 Hepatobiliary System, 602
 High-frequency ventilation, 155
 High-molecular-weight solutions, 230
 Hirudineans, 539
 Histopathology effects, of local anesthetics,
 63–64
 Horseshoe crab, 540
 Hot-plate test, 551–552
 Housing, single and group, 221
 HPA. *See* Hypothalamic-pituitary-adrenal
 (HPA)
 HPA axis hormones, 213
 HPA (hypothalamic-pituitary-adrenal) axis,
 activation of, 212
 Human anesthesia equipment, 130, 148–150
 Humidity levels, for animals, 621
 Humphrey valve, 144
 Husbandry staff, role of, 204
 HVAC (heating, ventilation, and
 air-conditioning) system, 188
 Hydration, 229
 Hydromorphone, 609, 611, 612, 614
 in ferrets, 447
 Hydromorphone hydrochloride, 611
 5-hydroxy-tryptamine (5-HT), 9
 Hypercapnoea, 596
 Hypertension, 353
 Hypnodil, 37
 Hypnorm. *See also* Fentanyl-fluanisone
 rabbits, 314
 rodent, 261
 Hypnosis, in rabbits, 320
 Hypoglycemia, 367
 primates, 357
 Hypotension, 229, 350
 intraoperative, with isoflurane, 354
 Hypothalamic-pituitary-adrenal (HPA) axis,
 10, 583, 597
 Hypothermia, 227
 cats, 376
 in cephalopods, 537
 dogs, 377
 in fish, 531
 neonatal rodents, 278
 primates, 352, 357
 Hypovolemia, 382
 Hypoxemia, 368, 596
- I**
- IASP. *See* International Association for the
 Study
 of Pain (IASP)
 Iatrogenic burns, 231
 Iatrogenic injury, 621
 Ibuprofen, 106–107
 rodents, 272–273
 ICUs. *See* Intensive care units
 Idazoxan, 53
 Imaging modalities
 gating, 632–633
 MRI/S, 632
 optical imaging

- Imaging modalities (*Contd.*)
 bioluminescence, 631
 fluorescence, 631
 LDI, 632
 SPECT, 632
 ultrasound, 631
 x-ray-based technologies
 dual-energy x-ray absorptiometry, 630
 microcomputed tomography, 630–631
 radiography, 630
- Imidazole, in fish, 525–526
- Immersion anesthesia
 in amphibians, 514–515
 in fish, 523–529
 best practices agents, 524–526
 inappropriate agents, 528
 infrequently used agents, 526–528
 not recommended agents, 528–529
- Immune system effects
 of cyclohexamines, 50
 of local anesthetics, 64
 urethane, 58
- Inapsine, 55
- Indomethacin, 105–106
- Induction boxes, 187
- Induction chambers, 155–156
- Induction of anesthesia
 in adult ruminants, 397–398
 in small ruminants, 395–397
- Infection, 230–231
- Infiltration block, 61
- Inflammatory mediators, role in peripheral sensitization, 11
- Inflammation, 206, 230–231
- Inflammatory models, 554
- Infrared spectrophotometry, 190
- Infrared spectroscopy, 93
- Infusion syndrome, propofol, 41
- Inhalant anesthesia, 389
- Inhalants
 cats, 374
 dogs, 374
 rabbits, 317
- Inhalation, 598
- Inhalational agents
 for foetuses, 599
- Inhalational anesthesia, during imaging, 637
- Inhalational anesthetics, 83–84
 agents, 90–92
 in arachnids, 539
 in bats, 473
 in birds, 493
 characteristics of, 84
 chemical and physical properties, 84–89
 boiling point, 88
 level of biodegradation, 89
 molecular stability, 89
 molecular weight and vapor pressure, 85–86
 partition coefficients, 88–89
 vapor pressure, 84–85
 in ferrets, 450–452
 in insectivores, 462
 measurement and qualification for
 research, 92–94
 mode of action, 89
 in rabbits, 348–351
 in reptiles, 505–506
 for ruminants, 400
 in swines, 417–419
 delivery, 415–417
 uptake—distribution—elimination, 89–90
- Inhibitory interneuron apoptosis, 15
- Inhibitory neurotransmitters, 9
- Injectable anesthesia, during imaging, 637
- Injectable anesthetics, 28
 in amphibians, 516
 for armadillos, 472
 in birds, 490–49
 cats, 373
 delivery systems, 158–159
 dogs, 373
 dose, 28–29
 duration, 28
 in ferrets, 449–450
 in fish, 529–531
 GABA agonists, 29–47
 for grizzly bears, 474
 in insectivores, 462
 in marsupials, 460
 for nontraditional rodents, 466
 chinchillas, 470
 ground squirrels, 467
 prairie dogs, 468
 woodchucks, 469
 for prosimians, 475
 in reptiles, 506
 rodents, 256–261
 for spotted hyena, 474
 in swines, 419–422
 delivery, 415–417
- Injection, intramuscular
 rabbits, 306
- Injections
 intramuscular (IM), 390
 intravenous (IV), 390
 sites
 in Birds, 490
 in fish, 522
- Innovar Vet
 rabbits, 314
- Innovative Research, 232
- Inotropes, 353
- Insectivores, 459–461
 blood collection in, 462
 chemical restraint of, 462
 injectable analgesics for, 462
 injectable anesthetics for, 462
 manual restraint of, 461–462
- Insects, 541
- Inspiratory flow rate and phase, 151
- Institutional Animal Care and Use Committee (IACUC), 199, 449
 and Animal Welfare Act, 570–571
 monitoring plans and assessment of
 animal care program,
 225–226
 role in ethical issues, 567
- Institutional policies
 for animal welfare, 573
 for drug enforcement, 576
- Intensive care units (ICU), and fluorescent lights, 220
- Interagency Research Animal Committee (IRAC), 571
- Intermittent positive pressure ventilation (IPPV), 152
- International Association for the Study of Pain (IASP), 520
 definition of pain, 620
- Intramuscular injections, 232
 cats, 368
 dogs, 368
 rodents, 258
- Intraoperative
 hypotension, in ruminants, 407
 monitoring of reptiles, 508
 monitoring of swines, 423–424
 support to swines, 424–425
- Intraperitoneal anesthetics, 307
- Intrapulmonary chemoreceptors (IPC), 488
- Intravenous anesthesia, in reptiles, 506
- Intravenous fluid therapy, 230
- Intravenous injection, 598
- Intubation
 of adult ruminants, 399–400
 endotracheal, 191, 308–309, 398
 cats, 368–369
 dogs, 368–369
 primates, 348–349
 rabbits, 305
 equipment for rodents, 160–162
 intravenous
 rodents, 250, 251
 of small ruminants, 398–399
- Invertebrates
 analgesia in, 542
 anesthesia in, 536–542
 pain in, 542
- Ion channel modulators, for chronic pain, 585–586
- Isoflurane, 91–92, 599

- in amphibians, 515, 516
in birds, 394–395
cats, 374
dogs, 374
in ferrets, 451
versus halothane, 418
primates, 350
rabbits, 317
in reptiles, 505–506
rodents, 252–253
in snails, 536
in swines, 417–418
MAC, 417
vapour pressure, 84–85
Iso-PADs, 221
- J**
- Jackson-Rees circuit, 145
Jaw tone, 173
Jet ventilation, 155
Jugular vein, of ruminants, 390
- K**
- Kadian, 612
Kainate receptors, 9
Kapanol, 612
Ketamine, 47–50, 118, 389
to amphibians, 516
antagonists, 50
Australian giant crab, 540–541
biodisposition, 48
in birds, 491
cats, 380
combinations with other agents, 65–66
dissociative injectable combinations in ferrets, 448–449
dogs, 380
in fish, 529
for foetuses, 599
pharmacologic effects of, 48–50
primates, 340
rabbits, 312–313
in reptiles, 506
rodents, 257
for ruminants, 408
used in swines, 420–421
Ketamine-alpha-chloralose mixtures, 66
Ketamine-diazepam mixtures, 66
Ketamine-xylazine mixtures, 65–66
Ketoprofen, 106–107
Ketorolac, 106
Keyed filling adaptor, 137, 138
Keyhole limpet hemocyanin (KLH), 198–199
KLH. *See* Keyhole limpet hemocyanin (KLH)
- L**
- Laboratory animals, unique challenges of, 180
Laboratory Animal Welfare Act (LAWA), 562–563
Lactated Ringer's solution (LRS), 444
Lagamorpha, 470–471
Large animals
effect of thermoregulation, 228
impact of vocalization on, 222
record keeping, 233
Large tanks, 129
Laryngeal mask airway (LMA), 164–166, 191, 309–310
Laryngoscopes, 159–162
Larynx, in birds, 483
Laser Doppler imaging (LDI), 632
LDI. *See* Laser Doppler imaging (LDI)
Left atrial pressure, 429
Lepus americanus, 470
Lidocaine
in amphibians, 516
in birds, 492
cats, 380
for chronic pain, 585
in crayfish, 540–541
dogs, 380
effect on immune system, 64
in fish, 527
infusions used for cardiac arrhythmias in swines, 424
in reptiles, 506
for ruminants, 408
Light-emitting diodes, 220
Light levels
for animals, 621
Limulus amebocyte lysate (LAL), 540
Limulus polyphemus, 540
Linearity, 137
Lipocortins, response to stress, 197
Lipopolysaccharide (LPS) administration
with chloralose, 66
effects of, 34
Liposomal formulations
of analgesic drugs, 613–614
of hydromorphone, 613
of oxymorphone, 613
Liposomes, 613
Liquid anesthetic, vaporization to gaseous anesthetic, 85–86
Liver transplantation, 230
LMA. *See* Laryngeal mask airway (LMA)
Local anesthetics, 326. *See also* Bupivacaine; Lidocaine
in birds, 492
in reptiles, 506
in ruminants, 401
- Local anesthetics, 60–64
biodistribution, 61–62
mechanism of action, 60–61
pharmacologic effects, 62–63
tissue and histopathology effects, 63–64
Long-term potentiation, 14
Low Dead Space adaptors, 164
Low-flow anesthesia, 192
LRS. *See* Lactated Ringer's solution (LRS)
Lumbricus terrestris, 539
Lung myeloperoxidase activity, 34
- M**
- MAC. *See* Minimum alveolar concentration (MAC)
Macintosh blade, 159
Magnesium chloride (MgCl₂)
in cephalopods, 537
in echinoderms, 542
Magnesium sulfate, in abalones, 536
Magnetic resonance imaging, 355–356
Magnetic resonance imaging and spectroscopy (MRI/S), 632
Malignant hyperthermia (MH), in swines, 425
CPB anesthesia for, 430–431
dantrolene for, 426
of isoflurane in snails, 536
recognition of, 425–426
treatment and management of, 426
triggering agents for, 426
Manometer
breathing system, 136
cuff, 162–163
Manual restraint
of armadillos, 472
of bats, 473
of gray mouse lemur, 475
of grizzly bears, 473
of insectivores, 461–462
of lagomorpha, 471
of marsupials, 459
of nontraditional rodents, 466
chinchillas, 469–470
ground squirrels, 467
prairie dogs, 468
woodchuck, 468
of spotted hyena, 474
Mapleson circuits, 143–145
Marmota monax, 468
Marsupials, 458–459
analgesics for, 461
chemical restraint of, 459
fluid therapy in, 459
injectable anesthetics for, 460
manual restraint of, 459
sedatives/tranquilizers in, 460
vascular access in, 459

- Mask anesthesia
 cats, 368, 373–374
 dogs, 368, 373–374
 rodents, 250
- Mass spectrometry, 93–94
- Mastication, 386
- Mastomys natalensis*, 465
- Maternal anaesthesia, 599, 600
- Matrx VMS, 148
- Maximum inspiratory pressure, 151
- Measured flow vaporizers, 139–140
- Mechanical assays, 552–553
- Mechanical dead space, 142
- Meclofenamate, 106
- Medetomidine, 51, 52–53, 116, 117
 in birds, 491
 cats, 371
 dogs, 371
 primates, 343
 rabbits, 305, 306
 rodents, 262
 used as sedative in ferrets, 446–447
- Medetomidine-ketamine, 449
- Medical gas piping systems, 130
- Medical record, maintaining, 190
- Medical surveillance, 190–191
- Mefenamic acid, 106
- Meglumine, flunixin, 108
- Meloxicam, in rabbits, 326
- Meperidine, 113–114
 in rodents, 263
- Meta-analysis, and WAG pollution, 186
- Methadone, 114
 rats, 272
- Methemoglobinemia, 62
- Methohexital, 31–32
- Methohexitone, rabbits, 312
- Methoxyflurane (MOF), 86, 91
 and renal toxicity, 187
 for rodents, 255
- Metomidate, 37–38
 in fish, 526
 used as continuous IV infusion in swines, 422
- Mexiletine, for chronic pain, 585
- Mice. *See* Rodents
- Microcebus murinus*, 475
- Microcomputed tomography (MicroCT), 630–631
- MicroCT. *See* Microcomputed tomography
- MicroPET. *See* Micropositron Emission Tomography (MicroPET)
- Micropositron Emission Tomography (MicroPET), 632
- Microtus*, 464
- Midazolam, 44, 45, 46, 394
 in anesthetized swines, 419
 in birds, 491
 cats, 382
 dogs, 382
 in ferrets, 445–446
 primates, 344
 rabbits, 305
 rodents, 256
- Minimally invasive surgery, 204
- Minimum alveolar concentration (MAC), 86–88, 418–419
 in birds, 494
 for desflurane in swine, 418–419
 determination of, 86–87
 ED50, 87
 factors affecting variability of, 87–88
 for inhalational anesthetics in birds, 494
 of isoflurane
 in ferrets, 451
 in swines, 417
 for nitrous oxide in swine, 417
- Minute ventilation, in respiratory system monitoring, 177–178
- Minute volume, 151
- MK-1-IS veterinary anesthesia machine, 140
- Mobile anesthesia unit, 220
- Molecular stability, 89
- Molecular weight, vapor pressure and, 85–86
- Mollusks, 536–538
- Monitoring anesthesia, 171–181
 cats, 375–376
 core components, 172–174
 dogs, 375–376
 neuromuscular blockade, 180–181
 in primates, 351–352
 techniques, 174–180
- Monodelphis domestica*, 458
- Morphine, 110–113. *See also* Analgesics
 in amphibians, 517
 cats, 371
 dogs, 371
 in ferrets, 447
 in fish, 531
 primates, 347, 359
 in rabbits, 326
 rodents, 263
- Morphine sulfate, 611
- Mouse
 acute/tonic pain experimental models of, 550–554
 chemical assays, 553–554
 mechanical assays, 552–553
 thermal assays, 551–552
 chronic pain experimental models of, 554–556
 inflammatory, 554
 neuropathic, 554–556
- Mouse GasAnesthesia Mask Stoelting, 158
- Movement-based and manual therapies for pain
 chiropractic manipulation, 625
 hydrotherapy, 624
 massage, 625
 physical therapy, 624
- MRI. *See* Magnetic resonance imaging
- MRI/S. *See* Magnetic resonance imaging and spectroscopy (MRI/S)
- MS-Contin, 611
- Mucous glands
 in amphibians, 512
- Mucous membrane color, in respiratory system monitoring, 177
- Multimodal analgesia, 205
 for neonates, 605
- Multistation Rodent Anesthesia Delivery and Scavenging System, 157, 158
- Muscle relaxants, primates, 347–348
- Mus musculus*, 549
- Mycobacterium tuberculosis*, 554
- Myocardial protection, 428
- Mystromys albicaudatus*, 465
- N**
- Nabumetone, 108
- Nalbuphine, 114
- Naloxone, 114, 115
 primates, 347, 359
 used to reverse opioids, 422
- “Narcotic,” 110
- Narcotics, 231
- National Association of State Controlled Substances Authorities (NASCSA), 575–576
- National Institute for Occupational Safety and Health (NIOSH), 184
- National Toxicology Program (NTP), 59
- Natural killer (NK) cells, cytotoxicity of, 197, 198
- Na_V . *See* Voltage-gated sodium channels (Na_V)
- Needle and syringe safety issues, 577
- Nematodes, 541
- Neonatal analgesia, 594, 604–605
- Neonatal anesthesia, 594
 in ferrets, 454
- Neonatal development, pain and, 9–10
- Neonates
 anesthesia
 cats, 382
 dogs, 382
 rodents, 277–278
 multi-modal analgesia for, 605
 NSAID for, 605
 opioids for, 605
 pain assessment in, 605
 pain in, 10
- Neostigmine, 267
- Neotoma*, 464

- Nervous system
 cyclohexamines effects on, 49–50
 urethane effects on, 57
- Neuraxial analgesia, local anesthetics, 61
- Neuraxial anesthesia, local anesthetics, 61
- Neuroendocrine response to pain, 10–11
- Neuroimmune activation (NA), 583
- Neuroleptanalgesia, 64–65
 rodents, 261
- Neuroleptanalgesics, 314–315
- Neuroleptic sedative combinations, 447–448
- Neurological immaturity, 595
- Neurological procedures, in primates, 356–357
- Neuromuscular blockade in anesthesia
 monitoring of, 180–181
- Neuromuscular blocking agents
 in ferrets, 449
 used in reptiles, 506
- Neuronal model, activity-dependent, 12, 13
- Neurones, 595
- Neuropathic models, 554–556
- Neuropathic pain, 16, 200, 584. *See also*
 Chronic pain
- Neuroplasticity
 pain and, 11–14
 role in chronic pain, 14–16
- Neurotransmitters, excitatory and
 inhibitory, 9
- Newborns
 altricial, 596
 precocial, 596
- Nicotinic acid derivatives, 107–108
- NIOSH. *See* National Institute for
 Occupational Safety and Health
 (NIOSH)
- NIOSH Criteria Document, 184, 188
- Nitrous oxide, 318–319
 in birds, 494–495
 cats, 374
 as a cause of hematologic disease, 187
 dogs, 374
 as inhaled anesthetics, 90
 primates, 349
 rodents, 256
 in swines, 417
 and vitamin B₁₂, 187
- N*-methyl-d-aspartate (NMDA)
 antagonists, 47–50, 117–118
 channel antagonists, 205
 receptors, 9
 for treatment of chronic pain, 587–588
- Nociception, 5
 anatomy and physiology of, 5–8
 facilitation, 8
 modulation, 8
 projection, 6–8
 transduction, 5–6
 transmission, 6
 neuropharmacology of, 8–9
- Nociceptive pain, 4
- Nociceptive-specific (NS) neurons, 7
- Nociceptive stimuli, 595, 597
- Nociceptive threshold, 196
- Nondrug methods, 619
- Nondrug treatments for pain
 acupuncture, 626–627
 electroanalgesia, 625–626
 movement-based and manual therapies
 chiropractic manipulation, 625
 hydrotherapy, 624
 massage, 625
 physical therapy, 624
 thermal techniques
 cryotherapy, 622–623
 deep heating therapy, 624
 therapeutic heat, 623–624
- Non-nociceptive (N-NOC) neurons, 7
- Nonbreathing circuits, 451
- Nonbreathing systems, 143–145
- Nonsteroidal anti-inflammatory drugs
 (NSAID)
 in birds, 493
 cats, 378–379
 dogs, 378–379
 in fish, 531
 for foetuses, 600
 to neonates, 605
 potency, 99
 preemptive analgesia with, 205
 primates, 358
 rabbits, 326
 rodents, 272–274
 serum half life and activity duration of
 propionic acid derivative, 108
 in swines, 423
 for treatment of chronic pain, 587
- Norepinephrine, 9
- Normative ethics, 563–564
- North American Drager 2A, 149
- Noxious stimulation, 597–598
- NSAID. *See* Nonsteroidal anti-inflammatory
 drugs (NSAID)
- Numeric rating scales (NRS), 211
- Nutrition
 postoperative
 rabbits, 323
 rodents, 249
- O**
- Observer training, 207
- Obstetric anesthesia, 353–354
- Occupational Safety and Health
 Administration (OSHA), 184
- Ochotona princeps*, 470
- Ochotona rufescens*, 470
- Octodon degus*, 470
- Octopuses, 537
- Octopus vulgaris*, 538
- Ocular reflexes, for anesthetic depth, 174
- Office of Laboratory Animal Welfare
 (OLAW), 571
- Ohmeda Excel 210, 149, 150
- Olfactory stimuli, 621
- Oligochaetes, 539
- Onychomys*, 465
- Open interface scavenging systems,
 140, 141
- Ophthalmic procedures
 in rabbits, 320
- Opioids, 109–110. *See also* Analgesics
 agonists, 197, 199
 antagonists, 115
 in birds, 493
 cats, 371, 378
 for chronic pain, 586
 continuous IV infusions used in swines,
 421–422
 dogs, 371, 378
 effect on behavioral changes, 210
 extended-release, 611
 in ferrets, 447
 in fish, 531
 for foetuses, 600
 with mixed actions, 114–115
 for neonates, 605
 polymers embedded with, 611
 primates, 346–347
 rabbits, 305–306
 receptors, 111
 rodents, 263–264
 for ruminants, 394–395, 408
- Optical imaging
 bioluminescence, 631
 fluorescence, 631
 LDI, 632
- Oral drug administration, rodents, 272
- Oral opioid formulations, 611
- Oramorph, 611
- Orbital bleeding, anesthesia for, 258
- Oryzomys palustris*, 463
- OSHA. *See* Occupational Safety and Health
 Administration (OSHA)
- Osmotic pumps, 612
- Oxicams, 107
- Oximetry, pulse
 in respiratory system monitoring, 178
- OxyContin, 612
- Oxygenation monitoring in birds, 495–496
- Oxygen flush valve, 134
- Oxygen supply failure, 134
- Oxymorphone, 111, 112, 609, 611, 612, 614
 cats, 371
 dogs, 371

- Oxymorphone (*Contd.*)
 primates, 358
 rodents, 264
 route of administration, 113
- P**
- PACU. *See* Postanesthesia care unit (PACU)
- Pain, 98, 596, 598
 acute, 4
 assessment in neonates, 605
 auditory, 596
 behavioral effects, 198
 chronic. *See* Chronic pain.
 cognitive and emotional components of, 196
 cycle, 98
 defined, 3–4
 definition, 28
 diagnosis of neuropathic, 584
 effective control of surgical, 197
 experimental models, 11
 in fish, 520
 IASP definition of, 520
 in invertebrates, 542
 in lower animals, 196
 management. *See* Pain management.
 monitoring, 206
 neonatal development and, 9–10
 neuropathic, 16
 neuroplasticity and, 11–14
 physiological effects of, 197–198
 physiologic effects of, 10–11
 postoperative, 198
 prevention, 203–205
 ratio with number of animals, 566–567
 reporting in USDA Categories, 564–565
 severity of, 200–203
 and stress, 197
 testing in mouse, 550–557
 experimental models of acute/tonic pain, 550–554
 experimental models of chronic pain, 554–556
 factors affecting, 556–557
 threshold, 4–5
 tolerance, 5
 types, 199–200
- Pain control, nonpharmacologic methods, 620
- Pain detection threshold, 196
- Pain management
 in amphibians, 517
 chronic. *See* Chronic pain.
 and ethical issues, 564–565
 in ferrets, 453–454
 in reptiles, 508
- Pain perception, 597
- Pain scoring systems, 210–211
- Pain tolerance threshold, 196
- Papaver somniferum*, 110
- Parabronchus. *See* Tertiary bronchus
- Parasympatholytics, 301
- Paravertebral anesthesia, in ruminants, 402–403
- Partial sciatic nerve ligation (PSL) model, 555
- Partition coefficients, 88–89
- Parturition, 601
- Passive scavenging, 140
- PCWP. *See* Pulmonary capillary wedge pressure (PCWP)
- Pediatric anesthesia
 primates, 354–355
- Pediatric circle systems, 143
- Penlon Sigma Delta vaporizer, 139
- Pentazocine, 114
- Pentobarbital, 32, 395
 administration route, 32
 cardiovascular effects, 32–33
 cats, 372
 dogs, 372
 effect on ventilation and blood gases, 33
 immune system effects, 34
 primates, 346
 rabbits, 310
 rodents, 259–260
 in snails, 536
 strain differences in dose-response, 33–34
 in swines, 421
 tolerance, 33–34
- Periaqueductal gray (PAG), 8
- Perinatal morbidity, 594
- Perinatal mortality, 594
- Peripheral benzodiazepine receptors (PBR), 46
- Peripheral sensitization, 11–12
- Peripheral sensory receptors, 595
- Permissible exposure limits (PEL), 576
- Peromyscus*, 464
- Petaurus breviceps*, 459
- Pharmacodynamics, 598
- Pharmacokinetics, 598, 599
 of buprenorphine, 610
- Phenobarbital, in birds, 492
- Phenothiazine, acepromazine, 393–394
- Phenothiazines, 54, 55
- Phenotypic switching, 15
- Phenoxyethanol
 in abalones, 536
 in fish, 528
- Phenylbutazone, 104–105
 half-lives in several species, 105
- Phenylephrine, for hypertension, with isoflurane, 353
- Phenylperidine, rodents, 263
- Phenytol, for chronic pain, 585
- PH gradients, 614
- Physical restraint
 of amphibians, 514
 of birds, 489
 to ferrets, 444
 of fish, 520–521
 of reptiles, 503
 of spiders, 539
- Physiologic dead space, 142
- Physiologic pain, 4
- Physiology
 cardiovascular, 601
 neonatal, 599
- Physostigmine, 267
 rodents, 264
- Piezoelectric crystal technique, 93
- PIM. *See* Pulmonary intravascular macrophages (PIM)
- Pin Index Safety System, 128
- Piston ventilators, 154
- Plasma fluoride concentration, 419
- Plexiglas pediatric unit, 228
- Pneumatic ventilators, 154–155
- Polychaetes, 539
- Polyvinyl chloride (PVC) endotracheal tubes, 162
- Positioning of ruminants, during anesthesia, 389
- Positive end expiratory pressure (PEEP), 151–152
- Positive pressure anesthesia ventilators, 151, 152
- Postanesthesia care unit, 187
- Postoperative care, for rodents, 268, 279
- Postoperative injections, 226
- Post-operative period, 604
- Postprocedural care, 220
 equipments, 223
 programmatic planning, 224
- Postprocedural housing, large-animal, 221–222
- Potorous tridactylus*, 459
- Pouring adaptor, 137
- Prealanesthesia
 in amphibians, 516
 in ferrets, 445–449
 in reptiles, 506–507
- Precision vaporizers, 85, 136
- Preemptive analgesia, 204–205
- Pregnancy, 595, 596
- Pregnanolone, 596
- Prescription monitoring programs (PMP), 576
- Pressure gauges, gas supply, 132
- Pressure regulation, 131–132
- Pre-term labour, 601
- Preventative strategies for pain control education, 620

- environmental enrichment, 621
 humidity level, 621
 light level, 621
 olfactory stimuli, 621
 social housing conditions, 620–621
 substrate, 621
 temperature level, 621
- Primates, nonhuman
 analgesic therapy, 358–359
 anesthetic agents
 alphaxalone–alphadolone, 238
 barbiturates, 346
 ketamine, 340
 opioids, 346–347
 propofol, 345
 Telazol, 344–345
 anesthetic management
 cardiac surgery, 340
 fluid administration, 353
 injection methods, 338
 intubation, endotracheal, 348–349
 monitoring, 351–352
 muscle relaxants, 347, 348
 in pregnancy, 353, 354
 premedication, 340
 diseases, zoonotic, 337
 species used in research, 336
- Priming, 64
- Procaine, in crabs, 541
- Professional codes of ethics, 562
- Professional organization position statements, 576
- Progesterone, 601
- Projection, 6–8
- Prolonged anesthesia
 in ferrets, 454
 in reptiles, 508–509
- Promethazine, 55
- Propanidid, in fish, 528
- Propionic acid derivatives, 106–107
 serum half-life and duration of activity of, 108
- Propiopromazine, rabbits, 305
- Propofol, 38–42, 389
 to amphibians, 516
 antagonists, 42
 biodisposition, 39–40
 in birds, 491–492
 cats, 372
 dogs, 372
 in ferrets, 450
 in fish, 529
 for foetuses, 599
 GABA agonists, 29
 immune system effects, 41
 pharmacologic effects, 40–41
 primates, 345
 rabbits, 315
 in reptiles, 506
 rodents, 260
 used in swines, 422
- Propofol infusion syndrome, 41
- Propofol phosphate, 40
- Proportioning systems, oxygen supply, 134
- Propriopromazine, 55
- Propylene phenoxetol, in oysters, 538
- Prosimians, 475
- Prostaglandin D₂, 596
- Prostaglandin E₂ (PGE₂), 100, 103
- Prostaglandins (PG), 100
 enzymatic pathways of conversion, 100, 101
- Protamine sulphate, 428
- Psammomys obesus*, 465
- Pseudocarcinus gigas*, 540–541
- Psychosocial factors, role in chronic pain, 16
- Public Health Service (PHS) policy, 563, 571–572
- Pulmonary artery occlusion pressure (PAOP), 177
- Pulmonary artery pressures, in cardiovascular system monitoring, 176–177
- Pulmonary capillary wedge pressure (PCWP), 429
- Pulmonary compromise, from pain, 11
- Pulmonary damage, 388
- Pulmonary function, 199
- Pulmonary intravascular macrophages (PIM), 389
- Pulmonary system, in birds, 483
- Pulse measures, in cardiovascular system monitoring, 175
- Pulse oximetry, in respiratory system monitoring, 178
- Purkinje fiber, 488–489
- Pycazolol derivatives, 104–105
- Q**
- Quinaldine sulfate, in fish, 525
- R**
- Rabbits
 analgesic therapy, 324–327
 anesthetic agents
 alphaxalone–alphadolone, 315
 barbiturates, 310–312
 inhalants, 317
 ketamine, 312–313
 neuroleptanalgesics, 314–315
 propofol, 315
 Telazol, 313
 urethane, 316
 anesthetic management
 cardiovascular support, 322–323
 fetal surgery, 320–321
 inhalation methods, 317–319
 injection sites, 306–307
 intubation, endotracheal, 308–309
 long-term experiments, 321
 monitoring, 321–323
 ophthalmic procedures, 320
 postoperative, 323
 regional methods, 319–320
 thermal support, 3223
 breeds, 301
 choice of experimental subject, 300
 fluid administration, 306, 323
 hypnosis, 320
 thiobutabarbital effects, 32
 unique features, 300
- Radiant heat paw-withdrawal (Hargreaves') test, 552
- Radiography, 630
- P-Aminophenol derivatives, 105
- Rapid-eye-movement (REM), 595, 596
- Rats. *See* Rodents
- Rats
 thiobutabarbital effects, 32
- Rebreathing systems, 142–143
- Record keeping, 233
- Reflex tests, in rabbits, 322
- Regional analgesia, in swines, 422–423
- Regional anesthesia, 264, 319–320
 in amphibians, 516
 cats, 381
 dogs, 381
 in fish, 531
 in reptiles, 506
- Regulatory ethics, 562–563
- Regurgitation, 387
- REM. *See* Rapid-eye-movement (REM)
- Remifentanyl, 113
- Remote capture, of ruminants, 398
- Remote video monitoring, 213
- Renal effects, of salicylates, 104
- Renal function
 cats, 382
 dogs, 382
- Renal toxicity, caused by use of methoxyflurane, 187
- Repeated anesthesia, 635
- Reperfusion, 228
- Reproductive abnormalities, 186
- Reptiles
 analgesics in, 508
 anatomical considerations, 502–503
 anesthesia of venomous species of, 503–505
 anesthetic induction in
 monitoring during, 508
 anesthetic maintenance, 516
 anesthetic maintenance of, 507

- Reptiles (*Contd.*)
 anesthetic techniques for, 503
 inhalational anesthetics, 505–506
 injectable anesthetics, 506
 regional/local anesthetics, 506
 body temperature of, 501–502
 glottis of, 502
 hematology and serum biochemistry of, 504
 intravenous anesthesia in, 506
 monitoring, 516
 neuromuscular blocking agents in, 506
 pain management in, 508
 physical restraint and handling of, 503
 preanesthesia in, 506–507
 preanesthetic evaluation and prepara, 503
 prolonged anesthesia in, 508–509
 recovery from anesthesia, 508
 routes of drug administration in, 505
- Reservoir bag, 135–136
- Respiratory acidosis, 103
- Respiratory effects
 of ketamine, 49
 of pentobarbital, 33
 of urethane, 58
- Respiratory pattern, monitoring, 228
- Respiratory rate
 monitoring, 177–179
 monitoring in cephalopods, 538
 monitoring in fish, 523
 in respiratory system monitoring, 177
- Respiratory system, 601. *See also*
 Respiratory rate
- Right-angle endotracheal tube adaptors, 164
- Ringer's solution, lactated, 230
- Rodent anesthesia machines, 146–147
- Rodent endotracheal tubes, 166
- Rodent face masks, 157
- Rodentia. *See* Rodents
- Rodents
 analgesic agents, 377–380
 anesthetic agents
 alpha chloralose, 265
 alphaxalone–alphadolone, 266
 barbiturate, 259
 carbon dioxide, 256
 inhalants, 250–256
 ketamine, 257–259
 neuroleptanalgesics, 261
 non-steroidal, 272–274
 propofol, 260
 Telazol, 261
 urethane, 265–266
 anesthetic management
 inhalation methods, 251–252
 intubation, endotracheal, 250, 251
 monitoring, 278–279
 neonates, 277–278
 postoperative care, 268, 279
 pregnant animals, 248
 regional methods, 264
 ultra-short procedures, 280
 effect of thermoregulation, 227
 intubation equipment for, 160–162
 methods of dose administration
 in, 231
 intramuscular, 232–233
 intraperitoneal, 233
 intravenous, 232
 oral, 232
 subcutaneous, 232
 transcutaneous, 232
 nontraditional species, 462–470
 chemical restraint of, 466, 467, 468, 470
 intraoperative management of, 466
 manual restraint of, 466, 467, 468, 469–470
 pain assessment, 268
 unique features, 266–267
- Romifidine, 53
- Rostroventral medulla (RVM), 8
- Ruminants
 cardiovascular system, 389
 digestive system, 386
 musculoskeletal system, 389
 nitrous oxide in, 90
 positioning of, during anesthesia, 389
 respiratory system, 387–389
 Restraint of, 389
 size, 386
- Ruminoreticulum, 387
- S**
- Saffan, 43. *See also*
 Alphaxalone–alphadolone
- Salicylates, 103–104
- Saliva, 386
- Saphenous veins, 415
- Scallop, 538
- Scandentia. *See* Insectivores
- Scavenging systems, 140–141
- Scoring assessment chart, 225
- Scorpions, 539–540
- Sea snails, 536
- Second gas effect, 90
- Sedation, 54
 on ruminants, 390
- Sedative hypnotics, rodents, 265
- Sedatives
 for marsupials, 460
 for nontraditional rodents, 466
 prairie dogs, 469
 for swines, 419–420
- Sensitization
 central, 12–14
 peripheral, 11–12
 role in chronic pain, 14–16
- Sentience, 595
- Serotonin, 9
- Sevoflurane, 92, 134
 in birds, 494
 cats, 374
 dogs, 374
 in ferrets, 451
 primates, 350–351
 rabbits, 318
 in reptiles, 506
 rodents, 254–255
 in swine, 418
- Sex differences, 556
- Sex hormones, effect on ketoprofen
 metabolism, 107
- Sigmodon hispidus*, 465
- Signal-to-noise ratio (SNR), 631
- Simple descriptive scales (SDS), 211
- Single-Photon Emission Computed
 Tomography
 (SPECT), 632
- Sleep time
 ketamine, 49
 pentobarbital, 33
- Small tank wrench, 129
- Small tank yoke, 129, 131
- Snails, 536
- Snorkel apparatus, 188
- Social context effects, 557
- Social Housing Conditions, 620–621
- Sodium pentobarbital, in snails, 536
- Sodium salicylate, routes of administration,
 104
- Somatic pain, 200
- SOPs. *See* Standard operating procedures
 (SOPs)
- Sorex araneus*, 461
- Spared nerve injury (SNI) model, 555
- SPECT. *See* Single-Photon Emission
 Computed Tomography (SPECT)
- Speculum, intubation, 161
- Spermophilus*, 467
- Spiders, 539–540
- Spinal anesthesia, in ruminants, 401–402
- Spinal cord, to brain projection, 6–7
- Spinal nerve ligation (SNL), 555
- Spinohypothalamic tract (SHT), 7
- Spinomesencephalic tract (SMT), 7
- Spinothalamic tract (STT), 7
- Spotted hyena, 474–475
- Sprague-Dawley rats, pentobarbital
 effects, 33
- Standard of care, 567
- Standard operating procedures (SOPs), 223
 development procedures, 228
- Standing bellows, 152

- State regulations, 575–576
- Steroids, 43–44
- Straight laryngoscope blades, 159
- Strain differences, 556
- Strains, effects of using anesthesia, 635–636
- Stresnil, 55–56
- Stress
- pain and, 197
 - physiology of
 - in primates, 338
- Stressors, 197
- Stylets, 166–167
- Subcutaneous anesthetics, 306
- Substrate, 621
- Sufentanil
- for opioid infusion in swine, 421
 - rodents, 258, 271
- Sulindac, 105–106
- Summit portable anesthesia machine, 146, 147
- Suncus etruscus*, 460
- Suncus murinus*, 460
- Supraspinal contributions, to chronic pain, 15–16
- Surgery
- foetal, 598, 599, 600, 601
 - for reduction of tissue injury, 204
- Surgical neuropathic pain models, 555
- SurgiVet Multi-Station anesthesia machine, 147
- Surveillance plan, monitoring
- direction of, 190
 - frequency of, 190
 - maintaining medical record, 190
 - sites, 190
- Swines
- alpha-chloralose in, 422
 - anesthetics delivery in, 415–417
 - anticholinergics in, 420
 - barbiturates used in, 421
 - benzodiazepines used for, 419
 - breed consideration of, 414
 - buprenorphine used in, 423
 - butyrophenone used in, 419–420
 - cardiac arrhythmias in, 424
 - continuous IV infusions opioids used in, 421–422
 - CPB in. *See* Cardiopulmonary bypass (CPB).
 - desflurane in, 418–419
 - dissociative agents in, 420–421
 - etomidate used as sedative in, 422
 - gas exchange components of, 486–488
 - intraoperative
 - monitoring, 423–424
 - support, 424–425
 - isoflurane in, 417–418
 - malignant hyperthermia (MH) in, 425
 - prevention and management of, 426
 - recognition of, 425–426
 - treatment and management, 426
 - triggering agents for, 426
 - metomidate used as continuous IV
 - infusion in, 422
 - nitrous oxide in, 417
 - NSAID used in, 423
 - postsurgical care of, 425
 - propofol used in, 422
 - regional analgesia in, 422–423
 - sedatives in, 419–420
 - Sylvilagus floridanus*, 470
 - Synthetic opioid agonists, 114
 - Synthetic ω -conotoxins, 15
 - Syrinx, in birds, 484
- T**
- Tachykinins, 60
- Tachyphylaxis, 60–61
- Tail-clip test, 552
- Tail-Flick (radiant heat) test, 551
- Tail vein, of ruminants, 390
- Tail-withdrawal (hot water) test, 551
- Tannenbaum's classification, of ethical issues, 562–564
- Tec 3 style vaporizer, 138
- Telazol, 66
- cats, 373
 - combinations in ferrets, 449–450
 - dogs, 373
 - primates, 344–345
 - rabbits, 313
 - rodents, 261
- Telemetry, 229
- Telemetry systems, 213
- Temperature preferences
- for animals, 621
- Tepoxalin, 109
- Tertiary bronchus, in birds, 486
- Thalamocortical connections, 595
- Thalamus, 595
- projection, 6–8
 - to cortex, 7–8
 - from spinal cord, 6–7
- Thermal assays, 551–552
- Thermal techniques for pain control
- cryotherapy, 622–623
 - deep heating therapy, 624
 - therapeutic heat, 623–624
- Thermoregulation, 227
- CNS monitoring, 179
 - large animals, 228
 - rodents, 227
- Thiamylal, 31–32
- rabbits, 311
- Thiobarbital
- rodents, 260
- Thiobarbiturates, 31–32
- Thiobutabarbital, 32
- Thiopental, 31–32
- cats, 372, 380
 - dogs, 372, 380
 - for foetuses, 599
 - immune system effects, 34
 - primates, 346
 - rodents, 260
- Thiopentone
- rabbits, 311
- Thomomys*, 463
- Tidal volume, 151
- in respiratory system monitoring, 177
- Tiletamine, 47, 48, 49–50
- Tiletamine–zolazepam
- in reptiles, 506
 - in swines, 420–421
- Tiletamine–zolazepam mixtures. *See* Telazol
- Time-release pellets, 612
- Time-weighted average (TWA) sampling, 189–190
- Tissue injury, reduction of, 204
- Tissues
- foetal, 595
 - placental, 595
- TIVA. *See* Total intravenous anesthetic drugs (TIVA)
- Tolazoline, 53
- Tolerance
- pain, 5
- Tolmetin, 106
- Topical anesthesia
- in amphibians, 516
- Topical local anesthetics, 63–64
- Total intravenous anesthetic drugs (TIVA), 389, 400–401
- Total parenteral nutrition (TPN), 226
- Trachea
- in birds, 483–484
 - of reptiles, 502
- Tramadol, 114
- Tranquilizers
- for marsupials, 460
 - for nontraditional rodents, 466
 - for swines, 419–420
- Transcription-and translation-dependent processes
- central sensitization, 13–14
- Transducer phosphorylation, 11
- Transduction, 5–6
- Transgenic rodents, 248
- Transient receptor potential ion channels (TRP), 6
- Transmission, 6

- Transplantation
 cardiac, in primates, 340
 neural, in primates, 356
- Transtracheal ventilation, 155
- Tribromoethanol. *See* Avertin
- Tribromoethanol (TBE), 42–43
 toxicity, 42
- Tricaine methanesulfonate (MS-222)
 in amphibians, 514–515
 in fish, 524–525
- Trichloroacetic acid, 35
- Trichloroethanol, 35
- Trichosurus vulpecula*, 458
- Tricyclic antidepressants (TCA)
 for chronic pain, 586
- Tube exchangers, 166–167
- Tumor growth, role of pain, 11
- Tumor metastasis, buprenorphine treatment
 for the
 treatment of, 198
- Tupaia glis*, 460
- T-Wall Cole tube, 163
- U**
- Ultraviolet photoreception, 220
- Unconsciousness, 595
 in fetuses, 596
- Unidirectional valves, 135
- Unitary Theory, 88
- United Kingdom, 577–578
- United States Department of Agriculture
 (USDA) pain/distress category, 199
- United States Occupational Safety and
 Health Administration (OSHA), 576
- Universal F circuit, 143
- Universal Nosecone nonbreathing system,
 157
- Urethane, 56–59
 with alpha-chloralose, 66
 biodisposition, 56–57
 cats, 373
 in cephalopods, 537
 dogs, 373
 mechanism of action, 56
 pharmacologic effects, 57–59
 rabbits, 316
 recommendation for fish, 528
 rodents, 265–266
- Urinary catheterization, 352
- Urinary System, 602
- Ursus arctos*, 473–474
- U.S. government safety guidelines, 184
- USDA. *See* US Department of Agriculture
 (USDA) regulations
- US Department of Agriculture (USDA)
 regulations, 570–571
 reporting pain and distress in, 564–565
- Utero procedures, 594
- Uterus, 595
- V**
- Vaisman, A.I., 185
- Valves
 adjustable pressure-limiting, 135
 Humphrey, 144
 unidirectional, 135
- Vaporizers, 85, 136–140
- Vapor pressure, 84–85
 molecular weight and, 85–86
- Vapor Wand, 156
- Variable-area flowmeters, 132–133
- Variable bypass vaporizers, 137–139
- Vascular access
 in gray mouse lemur, 475
 in grizzly bear, 474
 in marsupials, 459
 in spotted hyena, 475
- Vasodilation, peripheral
 rabbits, 301
- Vasopressors, intraoperative
 primates, 353
- Vecuronium, 267
 primates, 347
- Ventilation
 components of birds, 483–486
 control in birds, 488
 efficiency of anesthetized ferrets, 452
 monitoring in birds, 495
 nonrecirculating, 189
- Ventilators, 151–155. *See also* Ventilation
 and tidal volumes of ferrets, 451–452
- Ventricular premature contractions (VPC),
 448
- Ventrolateral funiculus (VLF), 7
- VetEquip 2 l Vented Chamber, 156
- Veterinarians, 562, 567
- Veterinary anesthesia machine, MK-1-IS,
 140
- Veterinary machines, 147–148
- Vincristine, 555–556
- Visceral pain, 200
- Visual analog scales (VAS), 211
- Vitamin B₁₂, and nitrous oxide (N₂O), 187
- Vitamin C, premedication of rabbits with,
 306
- Volatile anesthesia, for amphibians, 515
- Volatile anesthetics, in fish, 527
- Voltage-gated calcium channels, 6
 chronic pain, 14–15, 15
 role of local anesthetics, 60
- Von Frey filament test, 552–553
- W**
- WAG. *See* Waste anesthetic gas (WAG)
- Waste anesthetic gases (WAG), 185, 576
 adverse health effects of, 186–187
 and cancer, 186–187
 emissions, 191–192
 evacuation
 environmental effects of, 189
 equipment and techniques, 188–189
 historical perspectives of, 185–186
 meta-analysis, 186
 sources of, 187–188
- Web-based training resources and tutorials,
 227
- “Wedge” pressure, 177
- Wide dynamic range (WDR) neurons, 7
- Wind-up, 12
- X**
- Xenarthra. *See* Armadillos
- Xenon
 rodents, 256
- X-ray-based imaging technologies
 dual-energy x-ray absorptiometry, 630
 microcomputed tomography, 630–631
 radiography, 630
- Xylazine, 51, 52, 117, 387
 in birds, 491
 in combination with ketamine, 312
 combined with ketamine, 420–421
 ketamine, 65–66, 448
 primates, 340
 rabbits, 300, 305
 rodents, 262
 used as sedative in ferrets, 446–447
 used in swines, 420
- T**
- Yohimbine, 53, 305
 primates, 340
 rodents, 262
- Yoke, small tank, 129, 131
- Z**
- Zolazepam, 45–46, 394
 with tiletamine, 66
- Zygodontomys brevicauda*, 465