

Canadian Council on Animal Care



guidelines on:

***laboratory animal
facilities —
characteristics,
design and
development***

This document, the CCAC *guidelines on: laboratory animal facilities — characteristics, design and development*, has been developed by Drs David Neil and Donald McKay with the collaboration of the CCAC Facilities Standards Subcommittee:

Dr Laurence Schofield, Department of National Defence (Chair)
Dr Michèle Bailey, Cornell University
Mr Richard Bélanger, Ottawa Health Research Institute
Dr Sandra Fry, Canadian Food Inspection Agency
Dr Martin Kirk, University of Calgary
Dr Donald McKay, University of Alberta
Dr David Neil, University of Alberta
Dr Elizabeth Rohonczy, Canadian Food Inspection Agency
Dr Gilles Demers, Canadian Council on Animal Care
Dr Gilly Griffin, Canadian Council on Animal Care

In addition, the CCAC is grateful to those individuals and organizations that provided comments on earlier drafts of this guidelines document.

© Canadian Council on Animal Care, 2003
REVISION DATE: May 2020

ISBN: 0-919087-41-8

Canadian Council on Animal Care
1510-130 Albert Street
Ottawa ON CANADA
K1P 5G4

<http://www.ccac.ca>

TABLE OF CONTENTS

A. PREFACE	1	3.16 Laundry facilities	31
SUMMARY OF THE GUIDELINES LISTED IN THIS DOCUMENT	3	3.17 Toilets	31
B. INTRODUCTION	13	3.18 Staff break and meeting room(s) ..	31
C. THE CHARACTERISTICS OF A LABORATORY ANIMAL FACILITY	15	3.19 Mechanical and electrical space and distribution of services	31
1. Functional Imperatives of the Overall Facility	15	3.20 Corridors	32
2. Location	16	3.21 Barriers	33
3. Basic Components of an Animal Facility	17	3.22 Radiation shielded suites	37
3.1 Animal holding rooms	17	4. Functional Adjacencies	38
3.2 Procedure rooms	18	4.1 Personnel facilities	38
3.3 Surgery	21	4.2 Animal holding rooms	40
3.4 Clean and dirty loading docks ..	22	4.3 Procedure rooms	40
3.5 Animal reception area(s)	22	4.4 Surgical suite	41
3.6 Feed and bedding storage	23	4.5 Cage and equipment washing and sterilization	41
3.7 Waste storage	23	4.6 Clean cage and equipment storage	42
3.8 Waste elimination	23	4.7 Clean and dirty loading docks ..	42
3.9 Cage and equipment washing and sterilization	25	4.8 Animal reception area(s)	42
3.10 Clean cage and equipment storage	27	4.9 Feed and bedding storage	43
3.11 Sterilization	27	4.10 Waste storage	43
3.12 Janitorial closets	28	4.11 Necropsy area	43
3.13 Necropsy	29	4.12 Mechanical services	43
3.14 Personnel office and reception area	30	4.13 Corridors	44
3.15 Personnel changing rooms	30	5. Traffic Flow Patterns	45
		6. Materials and Finishes	47
		6.1 Walls	47
		6.2 Floors	47
		6.3 Ceilings	48
		6.4 Doors	48
		6.5 Windows	49
		6.6 Cabinets and other fixed equipment	49

- 7. Plumbing50
 - 7.1 Drinking water50
 - 7.2 Animal holding rooms51
 - 7.3 Procedure rooms51
 - 7.4 Personnel areas52
 - 7.5 Cagewash and sterilization areas52
- 8. Electrical52
 - 8.1 Electrical outlets52
 - 8.2 Equipment53
 - 8.3 Light fixtures53
 - 8.4 Monitoring and communication .53
 - 8.5 Emergency power53
- 9. Environmental Monitoring Systems ..53
- 10. Security54
- 11. Safety Equipment54
- 12. Environment54
 - 12.1 Sound55
 - 12.2 Light56
 - 12.3 Heating, ventilation and air conditioning (HVAC)59
- 13. Redundancy68

- 2.4 Mechanical systems79
- 2.5 Detailed design79
- 3. Construction80
- 4. Commissioning80

D. THE PROCESS FOR THE PLANNING, DESIGN AND DEVELOPMENT OF A LABORATORY ANIMAL FACILITY71

- 1. Programming71
 - 1.1 Information gathering and communication73
 - 1.2 Estimating the size and scope of project74
 - 1.3 Integrating the program76
- 2. Design78
 - 2.1 Conceptual design78
 - 2.2 Preliminary floor plans78
 - 2.3 Graphic test79

- E. REFERENCES81**
- F. BIBLIOGRAPHY82**
- G. GLOSSARY83**
- H. ABBREVIATIONS84**

APPENDIX A SUMMARY OF RELEVANT GUIDELINES85

APPENDIX B EXAMPLES OF DETAILED SPACE DESCRIPTIONS86

APPENDIX C A SIMPLIFIED EXAMPLE OF PRELIMINARY SIZE ESTIMATION FOR AN ANIMAL FACILITY93

APPENDIX D TRAFFIC FLOW PATTERNS100

APPENDIX E HEAT PRODUCTION104

LIST OF DIAGRAMS

Diagram 1: Conventional rodent room	18	Diagram 11: Barrier system	36
Diagram 2: Conventional dog pen room	19	Diagram 12: Flexible barriers — U shaped corridor	36
Diagram 3: Rodent holding room with single-sided ventilated racks	20	Diagram 13: Flexible barriers — double corridor	37
Diagram 4: Rodent room with double-sided ventilated racks, entrance anteroom and integral procedure room	20	Diagram 14: Functional adjacencies — entrance	39
Diagram 5: Procedure anterooms	21	Diagram 15: Functional adjacencies — animal holding	40
Diagram 6: Key components of a surgical suite	22	Diagram 16: Functional adjacencies — surgery suite	41
Diagram 7: Key components of a cagewash area	25	Diagram 17: Functional adjacencies — cagewash	42
Diagram 8: Key components of a necropsy suite	29	Diagram 18: Functional adjacencies — clean dock	43
Diagram 9: Possible locations for mechanical services	32	Diagram 19: Functional adjacencies — dirty dock	44
Diagram 10: Barrier challenges	34	Diagram 20: Clean/dirty corridor system	45

Diagram 21: Traffic flow in a conceptual animal facility	46	Diagram 30: Ventilated cage — positive pressure	67
Diagram 22: Recessed hose bib detail	51	Diagram 31: Ventilated rack — negative pressure	67
Diagram 23: Flushing drain pipe	52	Diagram 32: Ventilated cage — negative pressure	68
Diagram 24: Light mounting for interstitial space servicing	58	Diagram 33: Ventilated rack — positive/ negative pressure	68
Diagram 25: Exhaust filter detail	62	Diagram 34: Ventilated cage with scavenging system	69
Diagram 26: Differential pressure — cascade effect	63	Diagram 35: Dual HVAC system	70
Diagram 27: Differential pressure — air barrier effect	64	Diagram 36: Conceptual floor plan	79
Diagram 28a): One-sided intake and exhaust	65	Diagram 37: Preliminary floor plan	80
Diagram 28b): Central intake and exhaust	65	Diagram I: Conventional rodent room	87
Diagram 28c): High intake/low exhaust	65	Diagram II: Rodent room with double-sided ventilated racks	89
Diagram 28d): Mass air displacement	65	Diagram III: Rodent room with single-sided ventilated racks	89
Diagram 29: Ventilated rack — positive pressure	66		

laboratory animal facilities — characteristics, design and development



A. PREFACE

The Canadian Council on Animal Care (CCAC) is responsible for overseeing animal use in research, teaching and testing. In addition to the *Guide to the Care and Use of Experimental Animals*, vol. 1, 2nd ed. (1993) and vol. 2 (1984), which lay down general principles for the care and use of animals, CCAC also publishes guidelines on issues of current and emerging concerns (<http://www.ccac.ca>). The CCAC *guidelines on: laboratory animal facilities — characteristics, design and development* is the seventh document in this series, and has

been developed by Drs David Neil and Donald McKay, University of Alberta, with the collaboration of the CCAC Facilities Standards Subcommittee. These guidelines concentrate on the characteristics of a laboratory animal facility and hence do not cover all subject matter discussed in the *Guide to the Care and Use of Experimental Animals*, vol. 1, Chapters II and III (CCAC, 1993). The relevant sections of the *Guide* should be consulted for areas not covered by these guidelines.

SUMMARY OF THE GUIDELINES LISTED IN THIS DOCUMENT

C. THE CHARACTERISTICS OF A LABORATORY ANIMAL FACILITY

1. Functional Imperatives of the Overall Facility

General Guideline A:

Laboratory animal facilities must be designed to facilitate sanitation processes.

p. 15

General Guideline B:

Materials and finishes should be durable, impervious, and resistant to water and chemicals used in their sanitation.

p. 15

General Guideline C:

Appropriately-sized sanitation and, if required, sterilization equipment (e.g., cage washers and autoclaves) must be available to accommodate the needs of the facility.

p. 15

General Guideline D:

Good quality air at the appropriate temperature and humidity levels must be available to the animals at all times.

p. 15

General Guideline E:

Security systems that limit access to authorized individuals only must be in place.

p. 15

General Guideline F:

Groups of animals of different or unknown health status should be housed separately.

p. 15

General Guideline G:

Designated area(s) should be available within all laboratory animal facilities to carry out animal procedures.

p. 15

General Guideline H:

Adequate storage should be available for all cages and equipment not in current use.

p. 15

General Guideline I:

Clean activities and dirty activities should be segregated within the facility to reduce the potential for cross-contamination.

p. 16

2. Location

Guideline 1:

Laboratory animal facilities should be located to facilitate the receipt of animals and supplies, as well as the removal of wastes, and should be accessible to users.

p. 16

Guideline 2:

Laboratory animal facilities should be located to preclude both public access and the need for movement of animals and dirty cages through public areas.

p. 16

Guideline 3:

Laboratory animal facilities must have access to reliable services, including water, electricity and sewage disposal.

p. 16

Guideline 4:

Laboratory animal facilities must be located so as to ensure access to a high-quality source

of air. They should be located so that exhaust air does not enter the facility or other buildings. If this is not feasible, the incoming air and/or exhaust must be treated appropriately.

p. 16

3. Basic Components of an Animal Facility

Guideline 5:

Separate animal holding rooms should be available for: 1) each species; 2) each group of animals of different health status within a species; and 3) different animal use where the care and use regimes differ significantly.

Section 3.1 Animal holding rooms, p. 17

Guideline 6:

The size of an animal holding room should be determined by the species, the number of animals to be housed, the type of housing, the proposed animal use and the services needed. The room should hold the animals comfortably in a suitable environment with sufficient space to service the animals.

Section 3.1 Animal holding rooms, p. 17

Guideline 7:

Invasive procedures that may cause distress to other animals should be conducted in a procedure room rather than in an animal holding room.

Section 3.2 Procedure rooms, p. 18

Guideline 8:

Well-appointed procedure rooms should be available within the animal facility to reduce the need to transport animals to laboratories located outside the facility.

Section 3.2 Procedure rooms, p. 18

Guideline 9:

A separate procedure room should be used when specialized equipment is required and/or procedures are being conducted that require minimal distraction.

Section 3.2 Procedure rooms, p. 19

Guideline 10:

Surgery must be performed under aseptic conditions using currently acceptable veterinary standards.

Section 3.3 Surgery, p. 21

Guideline 11:

The receipt and disposal of clean materials (e.g., virus antibody-free animals, feed and bedding) and dirty materials (e.g., animals from random sources and soiled bedding) should be segregated. The loading dock(s) must be designed to restrict the entry of vermin into the animal facility.

Section 3.4 Clean and dirty loading docks, p. 22

Guideline 12:

There should be a separately ventilated area where animals can be uncrated, examined and held, if required, under appropriate environmental conditions before being introduced to an animal holding room.

Section 3.5 Animal reception areas(s), p. 22

Guideline 13:

Animal feed and bedding must be stored in a vermin-proof room, and should not be stored directly on the floor.

Section 3.6 Feed and bedding storage, p. 23

Guideline 14:

The waste storage area must be large enough to accommodate all waste accumulated between disposals.

Section 3.7 Waste storage, p. 23

Guideline 15:

The ventilation system for the waste storage area must be designed so that exhaust from this area cannot enter any part of the building or adjoining buildings.

Section 3.7 Waste storage, p. 23

Guideline 16:

Biohazardous waste, hazardous materials and waste containing radionuclides must be stored separately in appropriately appointed

areas and disposed of according to all federal, provincial and municipal requirements.

Section 3.7 Waste storage, p. 23

Guideline 17:

All waste products must be eliminated in a safe manner. If this cannot be accomplished through existing local services, then appropriate space and equipment must be incorporated into the plans to ensure the safe elimination of waste.

Section 3.8 Waste elimination, p. 23

Guideline 18:

Clean and dirty activities in the cagewash area must be segregated.

Section 3.9 Cage and equipment washing and sterilization, p. 25

Guideline 19:

The cagewash area must have adequate ventilation to maintain a safe environment conducive to human physical activity and to prevent the spread of vapor and contaminants.

Section 3.9 Cage and equipment washing and sterilization, p. 25

Guideline 20:

The dirty cage storage area(s) should be large enough to accommodate all dirty cages awaiting processing, unless there are alternative designated dirty staging areas with appropriate ventilation.

Section 3.9 Cage and equipment washing and sterilization, p. 25

Guideline 21:

The differential pressure on the dirty side of the cagewash area must be strongly negative to all surrounding areas.

Section 3.9 Cage and equipment washing and sterilization, p. 26

Guideline 22:

Mechanical cage washers must be of a size appropriate for their potential use and must effectively sanitize the portable cages. The

true efficacy of the cagewash equipment must be checked on a regular basis through the use of temperature and microbiological monitoring.

Section 3.9 Cage and equipment washing and sterilization, p. 27

Guideline 23:

Mechanical washers and/or designated areas should be used for pressurized washing of large equipment such as racks and large cages.

Section 3.9 Cage and equipment washing and sterilization, p. 27

Guideline 24:

Adequate areas for clean equipment storage must be available to accommodate clean equipment not in use. Clean equipment must not be stored in corridors or animal holding rooms.

Section 3.10 Clean cage and equipment storage, p. 27

Guideline 25:

Sterilization method(s) that are safe and effective for the required need should be selected.

Section 3.11 Sterilization, p. 27

Guideline 26:

Appropriate sterilization equipment should be installed in strategic locations where it will be the most effective, such as within the area in which it will be used or at the transition between zones of the animal facility.

Section 3.11 Sterilization, p. 27

Guideline 27:

Cleaning supplies and equipment must not be stored in corridors.

Section 3.12 Janitorial closets, p. 28

Guideline 28:

Necropsy facilities should be designed to protect the users and eliminate the potential spread of agents of laboratory animal disease.

Section 3.13 Necropsy, p. 29

Guideline 29:

Access to the laboratory animal facility should be controlled and regulated.

Section 3.14 Personnel office and reception area, p. 30

Guideline 30:

Personnel areas should be designed and strategically located to facilitate and encourage personal hygiene.

Section 3.15 Personnel changing rooms, p. 30

Guideline 31:

Each toilet should be enclosed in a separate room with the relative air pressure negative to surrounding areas.

Section 3.17 Toilets, p. 31

Guideline 32:

Aerosols associated with toilet flushing should be minimized by selection of appropriate equipment and proper placement of exhaust fans.

Section 3.17 Toilets, p. 31

Guideline 33:

Adequate space must be available to accommodate the mechanical and electrical services and to allow servicing of this equipment.

Section 3.19 Mechanical and electrical space and distribution of services, p. 32

Guideline 34:

Where possible, mechanical and electrical equipment should be located so that they are accessible from outside animal holding rooms and other critical areas such as surgical and necropsy suites.

Section 3.19 Mechanical and electrical space and distribution of services, p. 32

Guideline 35:

Corridors must be wide enough and have sufficient protection to permit the largest items of equipment, such as cage racks, to be moved safely without causing damage to the facility or the equipment.

Section 3.20 Corridors, p. 32

Guideline 36:

Barriers should be strategically located throughout the laboratory animal facility to minimize the potential for cross-contamination and to segregate incompatible activities.

Section 3.21 Barriers, p. 33

Guideline 37:

Current biosafety guidelines must be consulted in all cases where animals are infected with known human or animal pathogens.

Section 3.21 Barriers, p. 33

Guideline 38:

If an anteroom is to be used as a component of a barrier system, then it must be large enough to accommodate the largest materials that will pass through it such that only one door need be opened at a time.

Section 3.21 Barriers, p. 34

Guideline 39:

All suites where sources of radiation are to be used must meet current radiation safety guidelines as established by the Canadian Nuclear Safety Commission (CNSC) and must be approved for such use by the local radiation safety officer.

Section 3.22 Radiation shielded suites, p. 37

Guideline 40:

The radiation hazard area must be separated from other animal housing and work areas, be clearly identified as a hazard area, and have access restricted to necessary personnel only.

Section 3.22 Radiation shielded suites, p. 37

4. Functional Adjacencies**Guideline 41:**

The components of an animal facility should be organized according to function and should promote and facilitate biosecurity.

p. 38

Guideline 42:

The reception area should be located near the main personnel entrance to the facility.

Section 4.1 Personnel facilities, p. 38

Guideline 43:

Change and shower facilities should be located near the personnel entrance to the facility and, if required, at the transition area between zones within the facility.

Section 4.1 Personnel facilities, p. 38

Guideline 44:

Toilets may be placed within barrier units so that personnel do not have to go through a complete change of clothes every time they visit the washroom. For biocontainment facilities, current biocontainment guidelines should be consulted to determine the acceptability of washrooms within facilities.

Section 4.1 Personnel facilities, p. 38

Guideline 45:

The staff break room should be located at the perimeter of the facility and close to the personnel entrance and changing and shower facilities.

Section 4.1 Personnel facilities, p. 39

Guideline 46:

The cleanest animals in the facility should be easily serviced from the clean side of the cagewash or clean cage storage areas, while rooms holding the dirtiest animals in the facility should have good access to the dirty side of the cagewash area.

Section 4.2 Animal holding rooms, p. 40

Guideline 47:

Procedure rooms should be located as close as possible to the animal holding rooms they will serve.

Section 4.3 Procedure rooms, p. 40

Guideline 48:

The clean side of the cagewash area should be linked to the clean loading dock, bedding storage area, and clean cage and equipment

storage area. There should also be clean access back to the animal holding rooms. The dirty side of the cagewash area should be closely linked to the waste storage area and the dirty dock. Access from the animal holding rooms to the dirty side of the cage washer is also required.

Section 4.5 Cage and equipment washing and sterilization, p. 41

Guideline 49:

The clean cage and equipment storage area should be located near the clean side of the cage washer and the clean bedding storage area. There must be clean access from the clean storage area to the animal holding rooms and to most of the procedure rooms.

Section 4.6 Clean cage and equipment storage, p. 42

Guideline 50:

The loading dock(s) must open to the outside of the facility. The clean dock or port should have access to the clean animal reception area and the clean feed and bedding storage area. The dirty dock or port should be readily accessible to the waste storage area.

Section 4.7 Clean and dirty loading docks, p. 42

Guideline 51:

The clean animal reception area should be adjacent to the clean dock. The dirty animal reception area, if required, should be adjacent to the dirty dock.

Section 4.8 Animal reception area(s), p. 42

Guideline 52:

The feed storage area must be accessible from a clean receiving area and from the animal holding rooms.

Section 4.9 Feed and bedding storage, p. 43

Guideline 53:

The bedding storage area must be accessible from a clean receiving area and the clean side of the cagewash area, unless the bedding is to be transferred to the cagewash area via a vacuum system.

Section 4.9 Feed and bedding storage, p. 43

Guideline 54:

The waste storage area should be easily accessible from the dirty side of the cagewash area.

Section 4.10 Waste storage, p. 43

Guideline 55:

Necropsy is considered a potentially 'dirty' function and, therefore, should be located near other dirty functions in the facility, such as waste storage and disposal (e.g., incineration or hydrolysis).

Section 4.11 Necropsy area, p. 43

Guideline 56:

The placement of mechanical systems should be such that servicing has a minimal impact on the facility's environment. Where possible, mechanical systems should be located so that they can be serviced from areas separate from the animal holding and manipulation rooms.

Section 4.12 Mechanical services, p. 43

Guideline 57:

Corridors must be strategically located so that they interconnect the various components of the animal facility and enhance efficient traffic flow patterns.

Section 4.13 Corridors, p. 44

5. Traffic Flow Patterns**Guideline 58:**

Traffic flow within an animal facility should progress from the cleanest to the dirtiest parts of the facility.

p. 45

6. Materials and Finishes**Guideline 59:**

Materials and finishes should be durable, impervious and resistant to water and chemicals used in their sanitation. In addition, they must be resistant to damage by equipment used in the facility, such as cage racks, or they must be protected from damage. Ledges,

crevices, cracks and unsealed service penetrations that can harbor dirt and vermin should be eliminated wherever possible, and all hollow doors must be filled or completely sealed.

p. 47

Guideline 60:

The direction in which doors swing should be such that they are safe, do not impede traffic flow and complement the control of airflow where required.

Section 6.4 Doors, p. 49

Guideline 61:

Cabinetry in an animal holding room should be limited to that which is essential for the proper functioning of the room.

Section 6.6 Cabinets and other fixed equipment, p. 49

7. Plumbing**Guideline 62:**

Potable water must be available within the animal facility for both animal and human consumption. Water should be of a consistently high quality so that it does not affect research results.

p. 50

Guideline 63:

Ample hot and cold water must be available throughout the facility for sanitation purposes.

p. 50

Guideline 64:

Water must be available for all safety equipment, such as eyewash stations, emergency showers and fire sprinkler systems.

p. 50

Guideline 65:

Sinks, showers and toilets must be strategically located to accommodate good personal hygiene and to minimize the potential for contamination.

p. 50

Guideline 66:

Drains must be strategically located in areas where water may be used extensively for cleaning. Drains that are not used on a daily basis should be sealed when not in use or equipped with manual or automatic flushing systems.

p. 50

Guideline 67:

Laboratory biosafety guidelines should be consulted to determine whether effluent treatment is required.

p. 50

Guideline 68:

All animal holding rooms and/or their associated anterooms should have a hand washing sink, preferably located near the door.

Section 7.2 Animal holding rooms, p. 51

Guideline 69:

Floor drains should be strategically located and designed so that they can be sealed when not in use or easily flushed to maintain an effective water trap.

Section 7.2 Animal holding rooms, p. 51

8. Electrical**Guideline 70:**

All electrical outlets in animal rooms and in other areas where they may be exposed to water must have a ground fault interrupter (GFI) and be fitted with an all-weather cover.

Section 8.1 Electrical outlets, p. 52

Guideline 71:

If there is the possibility of using ventilated cage systems, change hoods or other electrical equipment in an animal room, this should be taken into consideration when planning the location and distribution of power to the room.

Section 8.1 Electrical outlets, p. 52

Guideline 72:

All electrical conduits through walls must be completely sealed to eliminate their potential use as routes for vermin or aerosols.

Section 8.1 Electrical outlets, p. 52

Guideline 73:

Electrical power outlets for portable equipment are required in most rooms of an animal facility, including animal holding rooms and corridors. These must be safe for both animals and humans, and must be readily accessible without the need for excessive use of extension cords.

Section 8.1 Electrical outlets, p. 52

Guideline 74:

The power for specialized equipment (i.e. cage washers, autoclaves, surgical lamps, automated plumbing units, etc.) must be sized and installed according to the recommendations of the manufacturers of the equipment.

Section 8.2 Equipment, p. 53

Guideline 75:

All light fixtures throughout the animal facility should be vapor-proof.

Section 8.3 Light fixtures, p. 53

Guideline 76:

An emergency power source must be available for all facilities holding animals for research, teaching and testing purposes.

Section 8.5 Emergency power, p. 53

9. Environmental Monitoring Systems**Guideline 77:**

Temperature, relative humidity and differential pressures should be monitored frequently in each and every animal holding room.

p. 53

11. Safety Equipment

Guideline 78:

All required safety equipment must be installed so that it meets safety regulations but does not compromise the functionality of the laboratory animal facility.

p. 54

12. Environment

Guideline 79:

Equipment and activities that generate large amounts of noise should be sound isolated from the rest of the animal facility.

Section 12.1 Sound, p. 55

Guideline 80:

Animals that are very sensitive to noise, such as rodent breeding colonies, should be located as far away as possible from noise-generating equipment or noisy animals.

Section 12.1 Sound, p. 55

Guideline 81:

Animals that produce large amounts of noise should be sound isolated from the rest of the facility.

Section 12.1 Sound, p. 55

Guideline 82:

Whenever possible, the frequency of the sound emitted by alarms and bells used in the animal facility should be selected in a range that does not affect the animals. Visual alarms may be used as an alternative in some cases.

Section 12.1 Sound, p. 55

Guideline 83:

Sound reducing features should be incorporated into the building structure. As well, sound systems should be used to mask noises generated within the facility.

Section 12.1 Sound, p. 56

Guideline 84:

In most animal rooms, and especially in rodent rooms, lighting should be designed to

provide at least two levels of intensity during the light cycle.

Section 12.2 Light, subsection 12.2.1 Photo-intensity, p. 57

Guideline 85:

Diurnal light cycles in animal holding rooms should be controlled and monitored centrally.

Section 12.2 Light, subsection 12.2.2 Photoperiod, p. 57

Guideline 86:

The wavelength of light should simulate the natural wavelengths of sunlight as closely as possible.

Section 12.2 Light, subsection 12.2.3 Spectral quality, p. 58

Guideline 87:

The heating, ventilation and air conditioning (HVAC) system(s) should provide a healthy and comfortable environment for the animals and for personnel working in the facility. The system(s) should also be capable of regulating the environment within minimally variable set limits in order to supply a consistently stable environment that will not contribute significantly to experimental variability. This includes the uniformly consistent supply of quality air to all microenvironmental units within a room.

Section 12.3 Heating, ventilation and air conditioning (HVAC), p. 60

Guideline 88:

HVAC systems in laboratory animal facilities must operate continuously 24 hours per day, year round.

Section 12.3 Heating, ventilation and air conditioning (HVAC), p. 60

Guideline 89:

The temperature of each animal room should be controllable within $\pm 1^\circ\text{C}$.

Section 12.3 Heating, ventilation and air conditioning (HVAC), subsection 12.3.1 Temperature, p. 60

Guideline 90:

The temperature of each room should be controlled separately.

Section 12.3 Heating, ventilation and air conditioning (HVAC), subsection 12.3.1 Temperature, p. 61

Guideline 91:

Relative humidity should be maintained between 40% and 60%, depending on the species, and controlled to $\pm 5\%$.

Section 12.3 Heating, ventilation and air conditioning (HVAC), subsection 12.3.2 Relative humidity, p. 61

Guideline 92:

Animal facilities should be supplied with 100% fresh air. Air should not be recirculated within the facility.

Section 12.3 Heating, ventilation and air conditioning (HVAC), subsection 12.3.3 Fresh air, p. 61

Guideline 93:

There should be no possibility within the system for cross-contamination of fresh air with exhaust air.

Section 12.3 Heating, ventilation and air conditioning (HVAC), subsection 12.3.3 Fresh air, p. 62

Guideline 94:

Air must be exhausted efficiently so that the contaminants in the facility environment do not accumulate beyond acceptable levels.

Section 12.3 Heating, ventilation and air conditioning (HVAC), subsection 12.3.4 Air exhaust, p. 62

Guideline 95:

Exhaust ducts should be fitted with filters at the room level to reduce the accumulation of particulate matter in the duct. All exhaust ducts should be tightly sealed.

Section 12.3 Heating, ventilation and air conditioning (HVAC), subsection 12.3.4 Air exhaust, p. 62

Guideline 96:

The rate of air exchange within a room must be such that clean, fresh air is available to all animals and personnel at all times. For conventional animal holding rooms, the HVAC system should be capable of supplying and exhausting 15 to 20 air exchanges per hour.

Section 12.3 Heating, ventilation and air conditioning (HVAC), subsection 12.3.5 Air exchange, p. 62

Guideline 97:

Differential pressures can be used to create an air barrier between two areas or zones of a facility. Differential pressures between areas of an animal facility should be set so that air flows from the cleaner areas of the animal facility to the dirtier or potentially contaminated areas.

Section 12.3 Heating, ventilation and air conditioning (HVAC), subsection 12.3.6 Differential pressure, p. 63

Guideline 98:

Air distribution within a room must be such that clean, fresh air is available to all animals and personnel at all times.

Section 12.3 Heating, ventilation and air conditioning (HVAC), subsection 12.3.7 Air distribution, p. 64

13. Redundancy**Guideline 99:**

HVAC systems should be designed to provide adequate air exchange and maintain critical air differential pressures during mechanical breakdowns and power outages.

p. 68

Guideline 100:

All animal facilities must have an emergency electrical supply capable of maintaining at least some of the functions of the HVAC system and essential services.

p. 68

B. INTRODUCTION

Facilities for the care and use of all animals in research, teaching and testing must be conducive to the well-being and safety of the animals, provide an appropriately-appointed and safe workplace for personnel, and establish a stable research environment. The CCAC *guidelines on: laboratory animal facilities — characteristics, design and development* is intended to assist the users and designers of laboratory animal facilities to achieve these objectives. The goal is to promote optimal levels of animal care and facilitate good research without curtailing new and innovative ideas for facility design. Therefore, these guidelines should be viewed as a tool for achieving acceptable standards and not as mandatory instructions.

The renovation or new construction of laboratory animal facilities must meet certain basic functional criteria to be in compliance with the spirit and intent of the CCAC. These basic criteria are outlined in the text of these guidelines.

The CCAC *guidelines on: laboratory animal facilities — characteristics, design and development* applies to animals such as rats, mice, rabbits, dogs and cats held in controlled environments, but not to those used in field settings. Facilities for farm animals, fish and short-term holding of captive wildlife are described in other CCAC guidelines (CCAC *guidelines on: the care and use of farm animals in research, teaching and testing*, in preparation; CCAC *guidelines on: the care and use of fish in research, teaching and testing*, in preparation; and CCAC *guidelines on: the care and use of wildlife*, 2003). However, many of the general principles described within this document are applicable to most species maintained in captive environments for the purposes of research, teaching and testing.

These guidelines do not attempt to address building codes or safety codes and standards.

It is the responsibility of consultant architects and engineers to address these issues in concert with the responsible institutional officials.

In the planning and design of biosafety containment facilities, the CCAC *guidelines on: laboratory animal facilities — characteristics, design and development* should be used in conjunction with current biosafety guidelines, such as the Health Canada (HC) *Laboratory Biosafety Guidelines* (1996) and the Agriculture and Agri-Food Canada (AAFC) *Containment Standards for Veterinary Facilities* (1996) (see Appendix A). Responsibility for the *Containment Standards for Veterinary Facilities* now rests with the Biohazard Containment and Safety Division of the Canadian Food Inspection Agency (CFIA) (<http://www.inspection.gc.ca/english/sci/lab/bioe.shtml>). The above biosafety guidelines must be implemented whenever facilities will be used to house animals that are experimentally infected with human and/or animal pathogens. The CCAC *guidelines on: laboratory animal facilities — characteristics, design and development* refers to barrier systems for reducing or minimizing cross-contamination since these are important concepts in all animal facilities. Barriers are commonly used to separate animals of different or unknown disease statuses, such as dogs, cats, mice, specific pathogen-free (SPF) animals and genetically modified animals.

These guidelines are divided into two major sections: 'The Characteristics of a Laboratory Animal Facility' and 'The Process for the Planning, Design and Development of a Laboratory Animal Facility'. The relevant guidelines for the various components or characteristics of laboratory animal facilities are clearly indicated as 'Guidelines' and highlighted in bold print. These are often followed with discussion or information that may be useful in the application of the guidelines. 'The Process for the Planning, Design and Development of a

Laboratory Animal Facility' outlines how these guidelines can be effectively incorporated into the planning, design and construction of laboratory animal facilities.

These guidelines are intended to be used as the basis for designing an effective and functional laboratory animal facility without being too prescriptive. Therefore, they should be used not only in the design of new laboratory animal facilities, but also in the renovation of existing facilities. These guidelines should be used as standards which existing

facilities strive to meet, with the understanding that new facilities are to be built, or renovations are to be made, to meet these standards as needs and budget dictate. The overall aim is to ensure the availability of facilities necessary to maintain appropriate standards of animal care and use.

Implementation of these guidelines requires the commitment of all individuals involved in the care and use of laboratory animals to exemplary practice in meeting the scientific and humane imperatives of animal-based research, teaching and testing.

C. THE CHARACTERISTICS OF A LABORATORY ANIMAL FACILITY

A laboratory animal facility should be designed to facilitate animal research and to minimize experimental variables while providing for the physiological, social and behavioral requirements of the research animals. This is often a difficult task to accomplish, especially when the diverse needs of different species and the requirements of the experiments are taken into consideration. In order to accommodate these needs, a laboratory animal facility usually requires separate areas for specific functions, specialized rooms and equipment, and closely-controlled environments. Laboratory animal facilities are very expensive to build and, therefore, it is important that any new facility or renovation be programmed, designed and built to meet the size and scope of current needs, and have the flexibility to meet future needs. Despite varying needs and many alternative design solutions, there are specific guidelines that should be considered when designing an animal facility. These recommendations form the basis for the CCAC *guidelines on: laboratory animal facilities — characteristics, design and development*.

1. Functional Imperatives of the Overall Facility

The purpose of a laboratory animal facility is to confine animals in comfortable, safe, stable environments that are conducive to the research, teaching and/or testing requirements. These animals often vary in their microbial background, and facilities should therefore incorporate barriers and routines to minimize cross-contamination. In addition, these animals defecate and urinate in their cages, thus contaminating their environment. The following general guidelines are meant to address these concerns. The application of these guidelines will be discussed in more detail in the sections which follow.

General Guideline A:

Laboratory animal facilities must be designed to facilitate sanitation processes.

General Guideline B:

Materials and finishes should be durable, impervious, and resistant to water and chemicals used in their sanitation.

General Guideline C:

Appropriately-sized sanitation and, if required, sterilization equipment (e.g., cage washers and autoclaves) must be available to accommodate the needs of the facility.

General Guideline D:

Good quality air at the appropriate temperature and humidity levels must be available to the animals at all times.

General Guideline E:

Security systems that limit access to authorized individuals only must be in place.

General Guideline F:

Groups of animals of different or unknown health status should be housed separately.

General Guideline G:

Designated area(s) should be available within all laboratory animal facilities to carry out animal procedures.

General Guideline H:

Adequate storage should be available for all cages and equipment not in current use.

General Guideline 1:

Clean activities and dirty activities should be segregated within the facility to reduce the potential for cross-contamination.

2. Location

The choice of site for an animal facility is extremely important and deserves serious consideration. Even when animal facilities are in existence, it may be more practical and economical to build a new facility in another location than to upgrade an existing facility. It can be very difficult, and occasionally impossible, to incorporate the sophisticated mechanical requirements and ideal traffic flow patterns into existing structures.

Guideline 1:

Laboratory animal facilities should be located to facilitate the receipt of animals and supplies, as well as the removal of wastes, and should be accessible to users.

Direct access to the outside for deliveries and waste disposal is desirable. It is recommended that facilities located on upper floors of a building be serviced by a minimum of two elevators, one for clean and one for dirty materials, unless stringent measures are taken to sanitize the elevator between use. Additional precautions, such as the use of enclosed containers for moving animals and materials (e.g., soiled cages), should also be taken, particularly where elevators are not dedicated strictly to the animal facilities. Access to the elevator(s) for the animal facilities should be as strictly limited as possible. Where elevators are required, it is recommended that the entrance to the elevator be in a vestibule in order to buffer the changes in differential air pressures created by the movement of the elevator in the shaft. It may also be possible to design the elevator shafts to reduce or eliminate this problem (e.g., a loop system).

Guideline 2:

Laboratory animal facilities should be located to preclude both public access

and the need for movement of animals and dirty cages through public areas.

Animal facilities should be located to deter public access or through-traffic, as well as to avoid the movement of animals, cages and waste through public corridors and elevators. The facilities should be readily accessible to animal users, yet easily secured. Space to carry out both routine and experimental procedures should be included within the confines of the laboratory animal facility, whenever possible, to reduce the need to transfer animals to and from investigators' laboratories. The movement of animals outside the animal facility should be discouraged due to stress caused to the animals, effects on research, contamination hazards and exposure of individuals outside the facility to laboratory animal allergens.

Guideline 3:

Laboratory animal facilities must have access to reliable services, including water, electricity and sewage disposal.

Access to public utilities, such as water, gas, electricity and sewage disposal, is essential and may also be an important economic consideration. These services must be reliable and backup plans must be in place in case of an emergency. The animal facility environments must be maintained as required, 24 hours per day, all year round.

Guideline 4:

Laboratory animal facilities must be located so as to ensure access to a high-quality source of air. They should be located so that exhaust air does not enter the facility or other buildings. If this is not feasible, the incoming air and/or exhaust must be treated appropriately.

The location of the animal facility within a larger building, or its location relative to surrounding buildings (existing or proposed), needs to be carefully studied. A good source of fresh air is essential. The need to discharge equivalent amounts of stale air without con-

taminating the air intakes of other units is critical. Contamination of the air intake of the animal facility with its own exhaust air (via the building air envelope) has also been known to occur.

In order to address the external adjacencies of an animal facility and their influence on facility air supply and exhaust, it is recommended that the fluid dynamics of the building mass and clustering under differing atmospheric conditions be defined. This may be achieved using computational fluid dynamics. In some circumstances, it may also be necessary to perform wind tunnel studies to predict performance. Relative to the cost of design and construction of an animal facility, the cost of fluid dynamic studies is modest.

3. Basic Components of an Animal Facility

3.1 Animal holding rooms

It is important when designing animal rooms to consider not only current needs, but also possible future requirements. In most animal facilities, animal use fluctuates according to changes in research personnel and projects. A versatile holding room will facilitate rearrangement in order to accommodate the cage racks and ancillary equipment necessary to house different species. In addition, versatile groupings of rooms will permit a variety of projects to be undertaken over a number of years. The ability to modify environmental parameters is also often necessary to accommodate various research needs.

Guideline 5:

Separate animal holding rooms should be available for: 1) each species; 2) each group of animals of different health status within a species; and 3) different animal use where the care and use regimes differ significantly.

Separate animal holding rooms should be available for animals of each species and from

each source, and often for individual projects. This permits better experimental control and reduces the potential for a widespread disease outbreak. Exceptions can be made where investigators are using the same species from the same source for similar experiments, such as the production of antibodies in rabbits or the housing of genetically modified mice. Mixing should be limited to groups that are socially compatible, of similar health status and on the same feeding schedule. Where mixing of animals from different sources is necessary, specialized room design, equipment and/or cages may help to achieve some degree of isolation (see Appendix B). For example, the potential for cross-contamination can be reduced by using controlled airflow cubicles, portable laminar airflow units and various forms of isolator cages used in combination with a change hood. Where necessary, different species (e.g., rats and mice) may be housed in the same vented cage rack.

Separate rooms are required for the quarantine and isolation of animals. For example, it may be necessary to isolate sick animals from healthy ones or to quarantine animals that have been removed from and then returned to the animal facility. Observation and conditioning rooms may also be required for observation, conducting detailed health examinations and conditioning newly-acquired animals, especially random source animals (e.g., random source dogs, cats, rabbits and wild animals).

Guideline 6:

The size of an animal holding room should be determined by the species, the number of animals to be housed, the type of housing, the proposed animal use and the services needed. The room should hold the animals comfortably in a suitable environment with sufficient space to service the animals.

The size of an animal holding room should be determined according to the species to be maintained and the number of pens, cages or cage racks required, while allowing for ade-

quate ventilation and servicing. The size and layout of individual animal holding rooms may be derived by applying the example of preliminary size estimation given in Appendix C to a detailed space description (see Appendix B). Examples of different animal holding room layouts are illustrated in Diagrams 1 to 4. Additional space may be required to conduct non-invasive procedures. Where animals are held in ventilated racks, space may be required to install an appropriate hood to permit more invasive procedures to be performed in the room.

Ventilated cage racks that supply ventilation individually to each cage on a rack are being used more frequently to house rodents, especially mice. These units should be placed in relatively large rooms due to the amount of space required to service them. Mobile change hoods are commonly used, therefore sufficient space must be available between

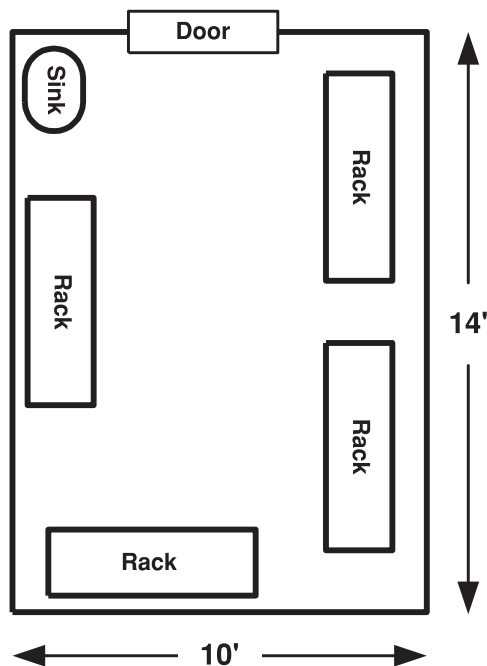

Diagram 1: Conventional rodent room

racks to accommodate the hood. In addition, there is often a stationary cabinet located within the room for the manipulation of mice (see Diagram 4).

Animal rooms should be designed for ease of sanitation and have a minimum of built-in equipment. In many cases, a single small sink for handwashing located near the door will suffice (see Appendix B), and may not be necessary if one is available in an adjoining ante-room. The use of mobile stainless steel sinks is also an option. In addition, space is required to accommodate room-specific sanitation equipment.

3.2 Procedure rooms

Guideline 7:

Invasive procedures that may cause distress to other animals should be conducted in a procedure room rather than in an animal holding room.

All procedures that might cause distress to an animal should be conducted outside the animal holding room since a distressed animal may convey alarm to conspecifics and induce unnecessary stress in other animals in the room. This may include relatively minor procedures involving transient restraint, such as injection or collection of small blood samples, especially where wild animals are involved, and includes all invasive procedures. Minor procedures, such as the injection of laboratory rodents, may be conducted in designated spaces within the animal holding room. Where rodents are housed in ventilated cage racks, procedures may be conducted within a procedure hood in the same room.

Guideline 8:

Well-appointed procedure rooms should be available within the animal facility to reduce the need to transport animals to laboratories located outside the facility.

Use of procedure rooms within animal facilities will reduce the introduction of non-

experimental variables and also reduce the spread of potential allergens outside the facility (see Section 4.3.1 Laboratory animal allergy and animals in laboratory settings). Flexibility of procedure rooms is important to provide for the evolving research needs of current and future users.

Anterooms can provide useful procedure space. Anterooms to animal holding rooms are referred to in different contexts in these guidelines. One of a number of uses is as a procedure room, dedicated to one (see Diagram 4) or more (see Diagram 5) animal holding rooms. The anteroom greatly reduces or eliminates the need to transport animals along common corridors to a multiple use procedure room. However, the use of shared multiple use procedure rooms by a number of different research groups increases the risk of introducing additional variables.

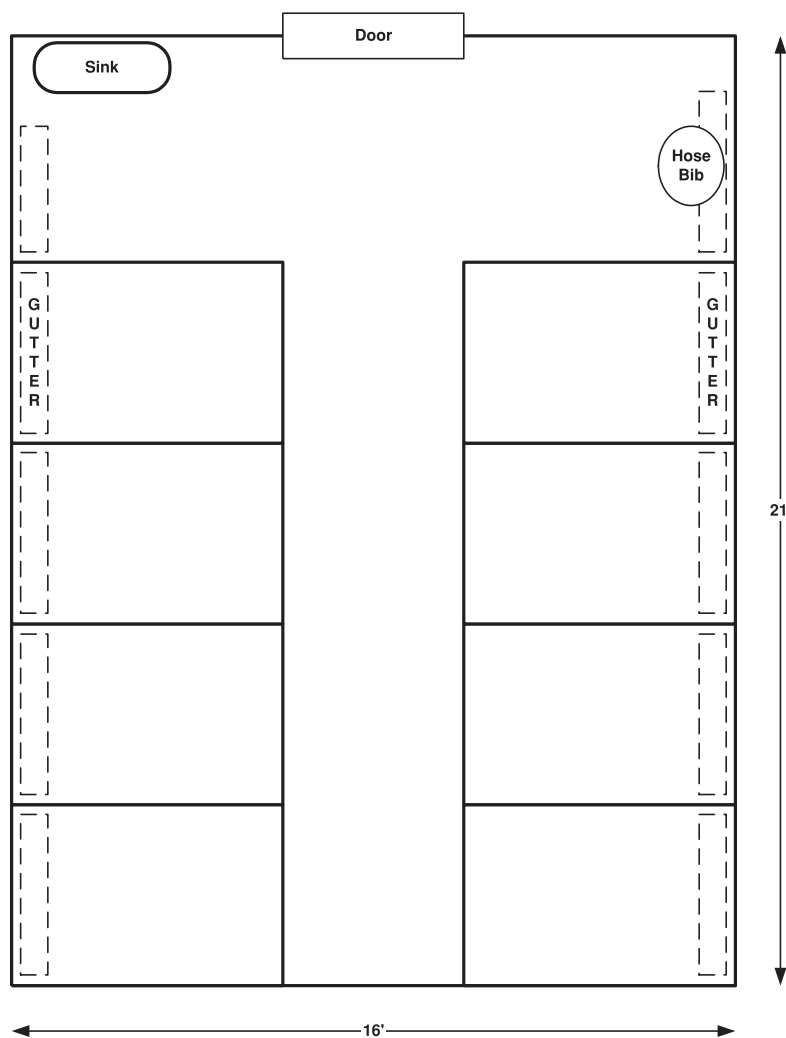

Diagram 2: Conventional dog pen room

Guideline 9:

A separate procedure room should be used when specialized equipment is required and/or procedures are being conducted that require minimal distraction.

Where procedures are more involved, and particularly if they are dependent on an array of equipment such as physiological monitors, imaging equipment and computers, a full procedure room is required. A procedure room is also often essential for many tests, such as behavior and drug tests, that are sen-

sitive to external distractions. These requirements should be carefully enumerated during the planning stages, and procedure rooms should be located strategically with respect to the proposed animal holding rooms. Some procedure rooms may be dedicated to one particular program for a period of time. In some circumstances, there may be 'clean' procedure rooms for disease-free animals and 'dirty' procedure rooms for conventional animals (animals whose background microflora is unknown). In all cases, the rooms must be designed to facilitate frequent sanitation

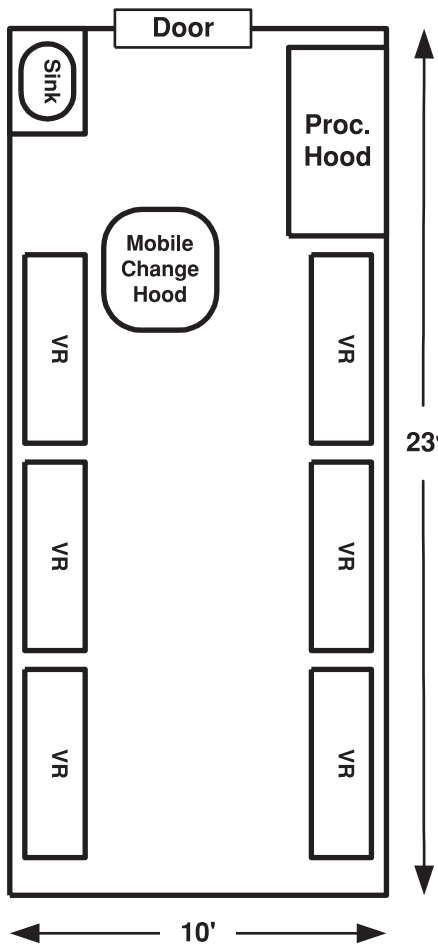

Diagram 3: Rodent holding room with single-sided ventilated racks

because of multiple use. It is very important to emphasize flexibility and adaptability in the design of procedure rooms since their use will inevitably fluctuate.

Environmental controls for procedure rooms should be the same as for animal holding rooms since animals may be held there for long periods during the day. Excellent lighting and substantial electrical outlets are essential (see Section C.8. Electrical).

The type and quantity of cabinetry in procedure rooms depends upon the proposed use.

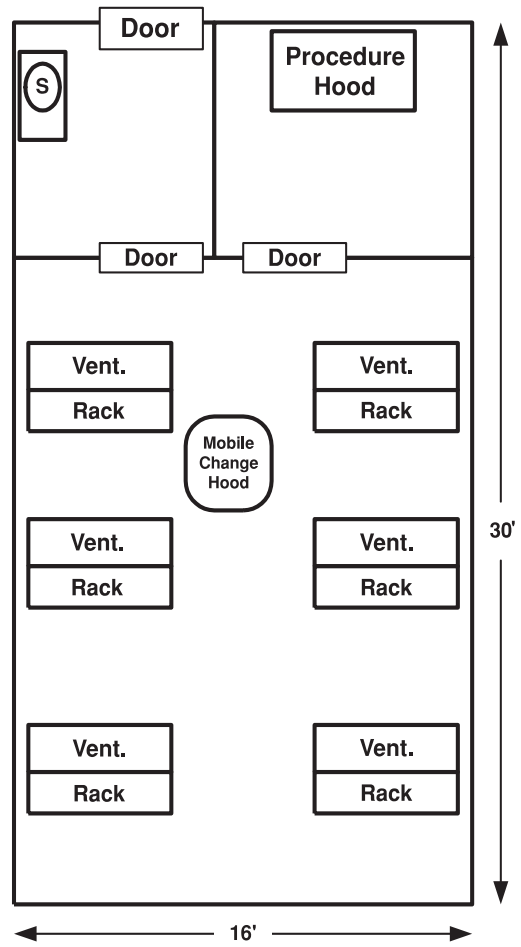

Diagram 4: Rodent room with double-sided ventilated racks, entrance anteroom and integral procedure room

Where the type of work is fairly similar over the years (e.g., toxicology testing), specific cabinetry needs can be accommodated on a permanent basis. In a multi-faceted and variable research climate (e.g., a large university), the needs change. Hence, permanent cupboards and drawers may become a problem. Material tends to accumulate in them and they are extremely difficult to clean and decontaminate. Consideration should be given to mobile tables, cupboards, shelves, etc. that can be used to finish procedure rooms appropriate to intermittent specific needs and that are readily sanitized.

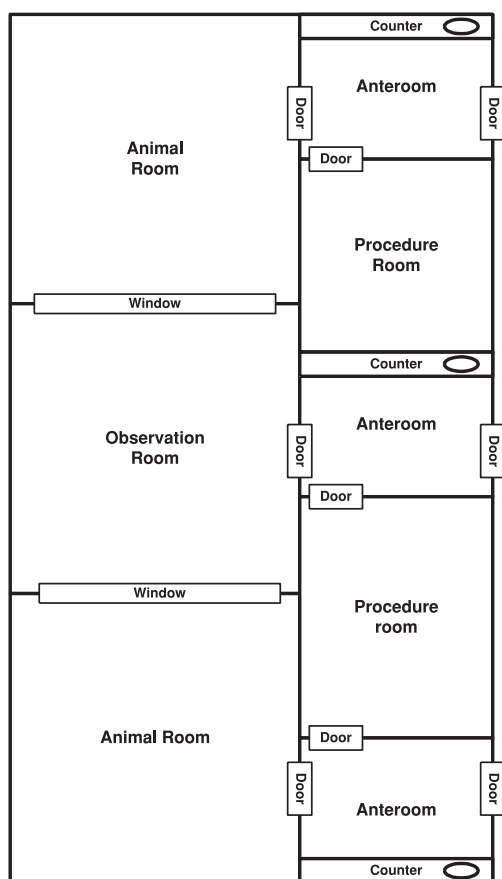

Diagram 5: Procedure anterooms

3.3 Surgery

Guideline 10:

Surgery must be performed under aseptic conditions using currently acceptable veterinary standards.

Facilities for experimental animal surgery are a frequently required component of laboratory animal facilities. The principal components of a well-appointed animal surgery are:

- surgeon preparation and scrub;
- animal preparation and premedication;
- surgical operation, including anesthesia;
- post-operative recovery;

- intensive care;
- surgical supply storage;
- equipment storage and servicing;
- instrument cleaning and storage; and
- surgical pack preparation, sterilization and holding.

Planning the number of rooms and overall space requirements to accommodate these functions will vary from project to project (see Diagram 6). The degree of sophistication required should be determined through consultation with the user groups, taking into consideration the species to be used and procedures to be performed. Some of the auxiliary functions can be combined within one space, depending upon the anticipated workload for the surgical suite. Where there is more than one operating room in the suite and/or higher use frequency, multifunctional ancillary rooms may be less useful.

It is highly recommended that surgical facilities be incorporated into the laboratory animal facility and that researchers be discouraged from transporting animals back to their own laboratories. This will facilitate monitoring and post-surgical care of the animals by the animal facility staff and will ensure adequate standards of sanitation.

Although the use of an appropriate operating theatre for all animal surgery is recommended, some more minor surgical procedures in small rodents may take place in a specifically-designated area of an investigator's laboratory suite. It must be reiterated that each functional component of a surgical suite must be considered in assigning the space and appointing it appropriately (CCAC, 1993, Chapter IX). In addition, if surgery is to be performed in a research laboratory, it is recommended that it be conducted under a constant stream of sterile air such as that supplied by a type II biosafety cabinet or a portable laminar flow unit.

Other considerations include the need for laundry facilities, centralized service consoles for gases and power, emergency power, and specialized scrub sinks. If gases are to be

piped in, it is preferable that space be allocated near the loading docks for holding gas cylinders (including spares), rather than in the surgical suite. Irrespective of location, gas cylinders must be carefully secured.

It is recommended that internal windows be incorporated into surgical suites to increase the visibility from one part of the suite to another. It has been found useful in experimental surgery suites to maximize visual communication from area to area. Limitations on the number of circulating personnel often require people to oversee multiple tasks (e.g., non-sterile circulation and post-operative monitoring). The use of internal windows also reduces closeness, increases safety and improves the perception of space.

3.4 Clean and dirty loading docks

Guideline 11:

The receipt and disposal of clean materials (e.g., virus antibody-free animals, feed and bedding) and dirty materials (e.g., animals from random sources and soiled bedding) should be segregated. The loading dock(s) must be designed to restrict the entry of vermin into the animal facility.

The functions of the clean and dirty loading docks may appear similar in that they both facilitate truck access for delivery and dispatch; however, the materials handled at each are quite different and incompatible. The clean dock should receive clean animals, food and bedding deliveries, and other clean supplies. The dirty dock should be used for the receipt of random source animals and wild

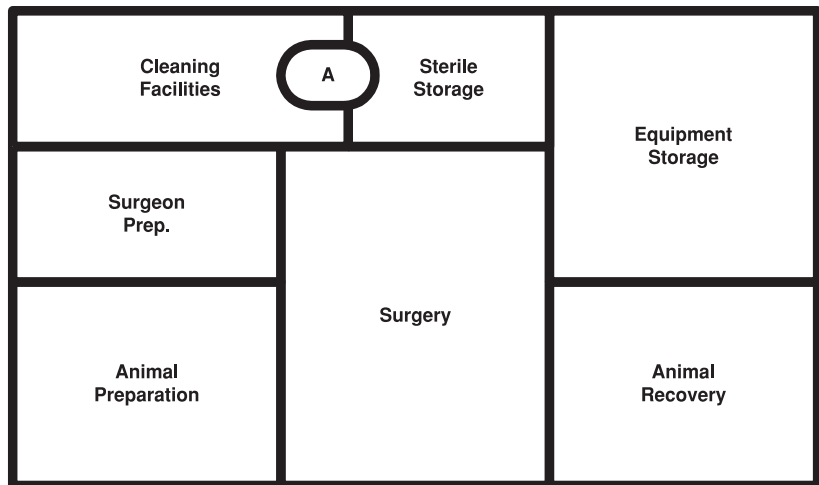

Diagram 6: Key components of a surgical suite

species, elimination of waste materials, and movement of other items of questionable sanitary status. Furthermore, the sources and movement of these materials within the facility is quite different, and it is often desirable to have the clean and dirty docks physically separate. Where this is not feasible and only one dock is available, there should be 'clean' and 'dirty' standard operating procedures (SOPs) with thorough decontamination of the area following 'dirty' activities. In Canada where feasible, it is advisable to have the animal facility docks enclosed and heated.

3.5 Animal reception area(s)

Guideline 12:

There should be a separately ventilated area where animals can be uncrated, examined and held, if required, under appropriate environmental conditions before being introduced to an animal holding room.

Ideally, there should be two animal reception areas, one for clean animals and one for dirty animals. The reception areas should provide sufficient space for the uncrating and initial examination of animals, as well as for holding

the animals under appropriate environmental conditions until they are relocated to a holding room or a conditioning area.

3.6 Feed and bedding storage

Guideline 13:

Animal feed and bedding must be stored in a vermin-proof room, and should not be stored directly on the floor.

Animal feed should be stored in a vermin-proof room that is easy to sanitize, in order to prevent contamination. Laboratory animal feed is produced free of contamination of food additives and is hygienically packaged immediately following pasteurization by the heat of the extrusion process. Laboratory feed may be stored at room temperature and a relative humidity of 50%, provided it is used in less than six months. Feed of this quality should not be stored together with foodstuffs from standard agricultural feed mills that may not have been consistently maintained in vermin-free facilities. All open bags of feed must be stored in sealed containers. Clean bedding may be stored in the same room as animal feed.

Feed and bedding should not be stored directly on the floor, but rather on plastic or metal pallets or shelves. It is also recommended that the pallets or shelves be located away from the walls, where possible, to facilitate cleaning and monitoring for vermin.

3.7 Waste storage

Guideline 14:

The waste storage area must be large enough to accommodate all waste accumulated between disposals.

Guideline 15:

The ventilation system for the waste storage area must be designed so that exhaust from this area cannot enter any part of the building or adjoining buildings.

The waste storage area should provide adequate storage for animal excrement, soiled bedding and waste feed, and should be designed to facilitate its sanitation. The ventilation for this area should be segregated from the rest of the building or at least designed so that there is no possibility of air leaking from this area into other parts of the building or other buildings. If the waste is not removed on a daily basis, then consideration should be given to cooling the waste storage room.

Guideline 16:

Biohazardous waste, hazardous materials and waste containing radionuclides must be stored separately in appropriately appointed areas and disposed of according to all federal, provincial and municipal requirements.

The Canadian Council of Ministers of the Environment (CCME) has released a set of recommendations and guidelines for the disposal of hazardous wastes. Specific wastes are addressed by the appropriate authority: the Canadian Nuclear Safety Commission (radioactive wastes), Health Canada and the Canadian Food Inspection Agency (biohazardous waste), and Environment Canada (chemical wastes). However, all guidelines and recommendations can be superseded by the local municipality which has ultimate regulatory authority. The exception to this is the transportation of hazardous wastes, regulated by the *Transportation of Dangerous Goods Regulations* (1992).

3.8 Waste elimination

Guideline 17:

All waste products must be eliminated in a safe manner. If this cannot be accomplished through existing local services, then appropriate space and equipment must be incorporated into the plans to ensure the safe elimination of waste.

The disposal of soiled animal bedding and the remains of dead animals can be handled in a

number of ways, depending on local codes, availability of acceptable waste elimination equipment, and the presence or absence of biohazardous agents and toxic substances in the discarded material.

In certain jurisdictions, it is permissible to send non-toxic and biosafe soiled laboratory animal bedding to appropriately-designated landfill sites. However, practices which require access to general public waste disposal systems may pose potential risks. Therefore, it is becoming increasingly necessary to consider equipment capable of reducing and rendering harmless the waste materials generated in the animal facility.

The requirement for waste elimination equipment to be a part of a new facility or for waste material to be transported to a shared public waste elimination facility should be clearly identified in the planning process. The decision will influence loading dock design, in addition to appropriate functional adjacencies and access to waste elimination equipment.

There are two principal methods of maximally effective and safe elimination systems: incineration, and alkaline hydrolysis or digestion.

3.8.1 Incineration

The disposal of soiled animal bedding and carcasses by combustion can be accomplished by high-temperature incineration. This can be achieved using a controlled air incinerator. The unit usually consists of two separate burning chambers. The waste material is loaded into the primary chamber either manually or by an automatic feeder. Here, the initial combustion takes place. The secondary chamber, usually mounted above the primary chamber, receives volatile substances and gases from the initial combustion process and pyrolytically converts them into simple, harmless chemical components.

The secondary chamber holds the exhaust material from the primary chamber long enough to expose it to a sufficiently high temperature to reduce everything to carbon diox-

ide, water vapor and heat energy before release into the atmosphere.

For animal carcasses, the secondary chamber retention time can range from 1.25 to 2.0 seconds. Although a temperature of 927°C (1700°F) is effective for tissues that are not chemically contaminated, a temperature of 1010°C to 1099°C (1850°F to 2000°F) is required to eliminate all potential toxic substances.

Incineration is an effective, albeit expensive, method of waste elimination. It uses large amounts of energy produced by the combustion of fossil fuels and contributes substantial quantities of carbon dioxide to the atmosphere. Therefore, it is extremely difficult to obtain permits for new incinerators in many jurisdictions. The permit is the first piece of information to be sought prior to pursuing this method of waste elimination.

3.8.2 Alkaline hydrolysis or digestion

Alkaline digestion is a relatively new process for laboratory animal disposal and consultation with established users prior to purchase and installation of a unit is recommended. In addition, the compatibility of the effluent with local codes should be investigated. Alkaline digestion converts animal tissues into a sterile, neutrally reactive, aqueous solution which can be disposed of in a sanitary sewer. There are some issues related to the disposal of the effluent; for example, pH is generally 11-12, the effluent can solidify in the waste piping, and biochemical oxygen demand levels can be greater than tolerable levels.

The process consists of placing the animal carcasses and tissues in the vessel. The machine automatically weighs the material and adds the appropriate quantity of alkali. Water is added to cover the material and the pressure vessel is then sealed. Digestion takes approximately 3 hours at 149°C (300°F). Large units have cycle times of up to 6 hours. Laboratory-sized tissue digesters are available with up to 5 kg (11 lb) capacity. These are used for laboratory rodent and rabbit carcasses. The smaller units may have application in

Biosafety Level 3 units. The laboratory-sized units operate at much lower temperatures (approximately 98°C) and the complete operating cycle may take up to 18 hours.

Importantly, the sterilization process also includes the destruction of prions, the agents of transmissible spongiform encephalopathies (CJD, vCJD, BSE, Scrapie and CWD).

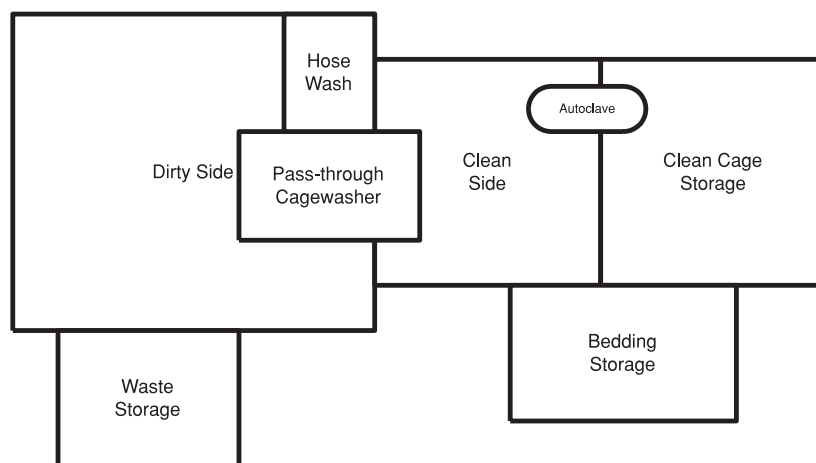

Diagram 7: Key components of a cagewash area

3.9 Cage and equipment washing and sterilization

Guideline 18:

Clean and dirty activities in the cagewash area must be segregated.

Guideline 19:

The cagewash area must have adequate ventilation to maintain a safe environment conducive to human physical activity and to prevent the spread of vapor and contaminants.

Guideline 20:

The dirty cage storage area(s) should be large enough to accommodate all dirty cages awaiting processing, unless there are alternative designated dirty staging areas with appropriate ventilation.

Diagram 7 illustrates the key components needed in a cagewash area. The dirty side of the cagewash area should be large enough to accommodate the accumulation of dirty equipment throughout the working day. The size is based on the rate at which dirty equipment can be processed through the cage

washing machine and the daily generation of dirty equipment. Overflow of unprotected dirty equipment in general access corridors or animal holding rooms is unacceptable. In large facilities or where the dirty cagewash area is limited, it may be necessary to design separate dirty staging areas with independent ventilation.

Space is also required for the manual or automated removal of soiled bedding. Sinks for hand washing and large deep sinks for pre-washing and/or washing specialized equipment are extremely useful in this area. If hose-down prewashing of either cages or racks is required (e.g., for large primate and dog cages), then a walled-off bay with hot and cold water and a disinfectant dispenser should be incorporated. Such bays need efficient exhaust air venting.

Robotic equipment can be used for dumping and preparing cages for cleaning. It reduces the workload, minimizes personnel exposure to allergens, potential biohazards, noise and heat, and can limit repetitive motion injuries. In most cases, the size of the dirty side of the cagewash area needs to be increased significantly to accommodate a robotic unit.

The aerosols generated in the sanitation of dirty cages and equipment (e.g., water bot-

bles) should be effectively contained. Vented hoods and filtered bedding disposal units should be used and need to be accommodated in the dirty area. Vacuum systems for soiled bedding removal are also available.

Dirty cages awaiting attention give off foul odors and gaseous ammonia, which is especially heightened at the time of soiled bedding removal. Therefore, ventilation in the cagewash area, particularly on the dirty side, is critical.

Guideline 21:

The differential pressure on the dirty side of the cagewash area must be strongly negative to all surrounding areas.

The washing machines generate a great deal of heat, and large amounts of steam are released when the doors are opened, especially on the clean side. Stainless steel exhaust vents adjacent to each washing machine door are strongly recommended. Steam must be effectively exhausted for the comfort and safety of personnel, to prevent the spread of contaminants, and to prevent damage to the surfaces in the washing area.

The washing machinery generates considerable noise. This is compounded by the disassembly and assembly of plastic and metal cages and other equipment in the area. In most busy cagewash areas, the sound level exceeds the decibel level acceptable for human safety, and personnel should wear approved protective auditory devices. Additionally, noise may be a problem if the cagewash is located in close proximity to animal holding areas. It is recommended that specific attention be paid to the sound attenuation and isolation of the washing machinery. The density of the peripheral walls of this area often needs to be greater than the normal sound attenuation specifications in the rest of the facility (e.g., sand-filled concrete masonry units, poured concrete, etc.). The use of cavity walls may also provide sound attenuation. There should be good doors both between the dirty side of the washing area and the corridor,

and between the clean side of the washing area and the corridor, for sound attenuation and to prevent the spread of contaminants.

The incorporation of an autoclave into the cagewash area is dependent on the type and needs of the facility and the SOPs that will be put in place. For a single or limited purpose facility, such as a genetically modified animal barrier facility, it may make sense to incorporate an autoclave into the cagewash area for sterilization purposes. However, for larger multipurpose facilities, a pass-through autoclave is best incorporated through the perimeter wall of a specific zone that will require its use, such as between the clean cage storage and a viral antibody-free (VAF) mouse unit.

Biosafety guidelines may require autoclave sterilization of the cages before cage washing. Depending on the facility, cage set-up and specified pathogen, the cages may have to be autoclaved prior to dumping the bedding. In most cases, it is preferable to locate the autoclave at the containment barrier.

Wherever possible, and certainly in all facilities in excess of 465 m² (5000 sq. ft.), it is recommended that pass-through cage washers be used. Therefore, following the completion of the cleaning cycle, the cleaned equipment is removed from the machine on the clean side of the cage or equipment washing area.

The clean side of the cage washer generally does not have to be as large as the dirty side since there is less activity in this area and the clean cages and equipment should be moved to clean cage storage or back to the animal holding rooms for immediate use. It is common practice to refill the cages with clean bedding in the clean area, and hence, there should be room for holding bedding and a bedding dispenser where required (note: ventilated automatic bedding dispensers reduce the exposure of personnel to airborne dust).

In small facilities, it may not be feasible to have separate clean and dirty areas, and hence, it is essential that cages be cleaned in small batches and that the area surrounding the cage washer be thoroughly sanitized before the clean cages are removed from the cage washer.

Guideline 22:

Mechanical cage washers must be of a size appropriate for their potential use and must effectively sanitize the portable cages. The true efficacy of the cagewash equipment must be checked on a regular basis through the use of temperature and microbiological monitoring.

Guideline 23:

Mechanical washers and/or designated areas should be used for pressurized washing of large equipment such as racks and large cages.

Sanitation and decontamination of cages, racks, water bottles and other washable and heat resistant items, such as carts and mobile stainless steel equipment, is best achieved using mechanical washing machines and autoclaves designed and programmed for this purpose. In addition to the consistency of effective operation and monitoring of these units, the cage washers provide a safe and effective means of applying detergents, disinfectants and descalers appropriate to the need. Cage washers should supply rinse water at a minimum of 83°C for at least three minutes.

3.10 Clean cage and equipment storage

Guideline 24:

Adequate areas for clean equipment storage must be available to accommodate clean equipment not in use. Clean equipment must not be stored in corridors or animal holding rooms.

Clean caging and equipment should move from the clean side of the cagewash area to an adjacent short-term holding area, usually referred to as clean cage storage or staging. Adequate clean equipment storage must be available to accommodate all clean equipment in active use. It is not acceptable to store

this equipment in corridors or animal holding rooms. Storage of equipment in active use is sometimes referred to as 'live storage'. Approximately 15 to 20% of net utilizable space of the animal facility should be allocated for live storage. The amount of required storage space is usually higher when there are a variety of species or groups of animals of different microbial status being held. Careful consideration should be given to the type of cages and equipment to be washed, as well as to the potential storage time, in order to estimate the actual storage requirements.

The long-term storage of equipment, or 'dead storage', is best achieved in designated storage areas outside the animal facility. This arrangement is much more cost-effective.

3.11 Sterilization

It is often necessary to sterilize cages, water bottles, bedding, feed and other equipment to be used in an animal facility or within specific zones. This is usually accomplished by physical and/or chemical means, such as autoclaving and fumigation.

Guideline 25:

Sterilization method(s) that are safe and effective for the required need should be selected.

Guideline 26:

Appropriate sterilization equipment should be installed in strategic locations where it will be the most effective, such as within the area in which it will be used or at the transition between zones of the animal facility.

3.11.1 Physical sterilization

Steam sterilization under pressure (i.e. autoclaving) is the principal means of sterilization for cages, water bottles, bedding and equipment in controlled research environments. In facilities where there is a requirement to pro-

vide sterilized equipment and food centrally, an autoclave can be located in the clean area of the cagewash or between the dirty and clean sides of the washing area. In some cases, a pass-through autoclave can be placed between the clean side of the cagewash and the clean equipment storage or staging area. Thus, bedding can be automatically dispensed in the clean side of the cagewash and then the cages containing bedding can be autoclaved through to the clean cage storage area.

Successful adaptation of dry heat sterilization chambers has recently been reported and may be considered a viable alternative in the future.

Ionizing radiation is not commonly used for sterilization purposes in animal facilities. It is used for the commercial sterilization of rodent diet manufactured for use in exclusion barrier units and wherever biosecurity is an issue. Its use has significantly reduced the amount of diet sterilized by autoclaving since the sterile food is now readily available commercially.

Ultraviolet light can be used to sterilize surfaces. Shaded areas are not sterilized and its use is therefore limited. However, it can be used to assist in reducing the microbial count in water treatment systems. Hazards include accidental exposure and possible ozone production in excess of allowable amounts. The costs of quality assurance and maintenance, as well as hazardous waste disposal, are all serious issues. Its application should be reviewed carefully with this in mind.

3.11.2 Chemical sterilization

Sterilization produced by exposing items of equipment and entire rooms to gaseous microbiocidal chemicals has had limited use in animal facilities. If this form of sterilization is to be used, it is important to ascertain that the materials selected for construction of the animal facility are compatible with the proposed chemical sterilant(s) and that the sterilization equipment or area in which it will be used can be maintained under negative pressure and effectively exhausted.

Pass-through chambers using microbiocidal chemical gases and vapors at exclusion and inclusion barrier interfaces are desirable for the sterilization/decontamination of larger items of equipment, particularly those that cannot be moist or dry-heat sterilized. Their use has been limited by the choice of effective chemical agents available.

Hydrogen peroxide vapor has proven to be an effective and safe chemical sterilant in animal facility scenarios. The vapor-generation apparatus is portable and, together with specific delivery systems, has a wide range of applications. Since the residue is oxygen and water only, it is non-toxic and ideal for use with experimental animals in controlled research environments. There are rack cage washers that can be used as the sterilization chamber in conjunction with the hydrogen peroxide sterilant units.

Ethylene oxide has been used in appropriate chambers and specific autoclave cycles, but not extensively. Safety concerns and chemical reactivity with certain materials (e.g., corn cob based products) has been a limiting factor. Formaldehyde gas and paraformaldehyde have been used successfully for many years as room sterilants, and they are also effective for sterilization of equipment within enclosed spaces. The gas is toxic, a serious irritant, and time consuming and tedious to use and vent effectively. This has limited its use in laboratory animal facilities, although it remains of value in decontamination of biocontainment rooms or suites and domestic farm animal barns following depopulation and prior to restocking. Chlorine dioxide gas has been demonstrated to be an effective sterilant in laboratory animal facilities but its use remains limited.

3.12 Janitorial closets

Guideline 27:

Cleaning supplies and equipment must not be stored in corridors.

Janitorial services from institutional building service units should not be used in animal

facilities for biosecurity and biosafety reasons. Separate cleaning supplies and equipment are required in different zones of the facility, and it is recommended that closets for the storage of janitorial materials and equipment be located in each distinct zone or activity area.

Each animal holding room must have its own dedicated cleaning equipment. Cleaning equipment must not be transferred from one room to another when the rooms are in active use.

3.13 Necropsy

The incorporation of a necropsy area, even in small facilities, is strongly recommended unless alternative necropsy services are readily available. A complete laboratory animal care and use program should monitor causes of death carefully as part of the health surveillance system. In addition, the detailed post-mortem examination of experimental animals is often required for scientific purposes. In facilities in which genetically modified animals are maintained, detailed necropsy is a means to discover valuable animal models of disease. Adequate necropsy facilities are therefore becoming increasingly important.

Guideline 28:

Necropsy facilities should be designed to protect the users and eliminate the potential spread of agents of laboratory animal disease.

The recommended components of a necropsy suite are listed below and shown in Diagram 8:

- the refrigerated cabinet or chamber;
- the anteroom; and
- the necropsy room.

It is important that the purpose and use of the necropsy area be clearly defined. If the sole purpose of the necropsy is to collect tissues from disease-free animals shortly after death, then a dedicated necropsy area may not be required. Under these conditions, it is often satisfactory to collect the tissues in the surgi-

cal suite, or for small animals, in a biosafety cabinet. However, if the necropsy area is to be used to collect tissue from animals of unknown health status or to diagnose the cause of death from unknown causes, especially in larger animals, then it is strongly recommended that a proper necropsy suite be incorporated into the animal facility.

The necropsy suite has the potential to be the most dangerous area of an animal facility due to possible exposure to agents of disease. Therefore, it is strongly recommended that the suite incorporate an anteroom. Anterooms offer an effective additional barrier to the facility as a whole by facilitating the staged use of protective clothing and by acting as an air lock, which helps maintain negative air pressure in the necropsy room itself relative to the adjacent areas. In addition, other safety equipment, such as surgery lamps, downdraft tables, washing facilities, emergency eye-wash, emergency shower, etc., should be considered when designing an effective and safe necropsy room.

The refrigerated chamber for storage of dead animals can be configured as a pass-through unit. This permits personnel to place animals into the cooler that is accessed from a general purpose corridor, without the need to take

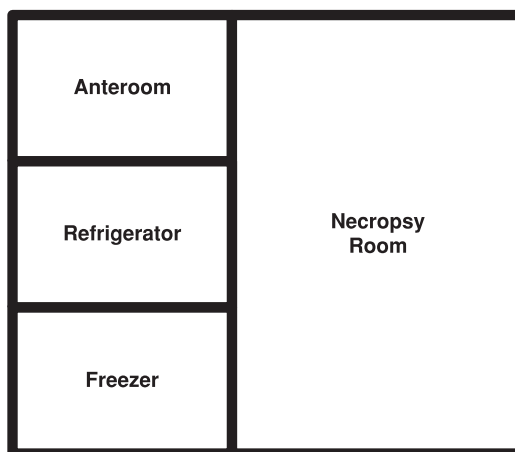

Diagram 8: Key components of a necropsy suite

elaborate precautions for biosecurity. The pass-through cooler acts like an air lock in this arrangement. The personnel within the necropsy suite can access the dead subjects and appended documentation without leaving the suite. This design concept is not restricted to facilities with larger workloads since appropriate pass-through units as small as domestic refrigerators are commercially available. Freezer units are also useful, especially when carcasses cannot be incinerated shortly after they are necropsied.

Ventilation must be effective to minimize aerosol concentrations and odors. The necropsy room must be at a negative air pressure relative to all surrounding areas. The air exhaust system should be configured to move polluted air away from the persons performing necropsies and safely expel it from the building. This is sometimes achieved using downdraft tables or exhaust vents at the back of the work surfaces. Occasionally, flexible exhaust snorkels are used, similar to those used by welders. For small animals such as laboratory rodents, a biosafety cabinet can be used.

Lighting is very important in the necropsy room. In addition to more intensive adjustable spot or flood lighting, the ambient light levels also need to be bright.

The design of the necropsy suite should facilitate thorough cleaning and disinfection (including fumigation if required).

The necropsy suite, if used for large animals, is subject to frequent wash downs, and large quantities of water are used on a routine basis. Floor drains are essential with baskets to capture materials that should be collected for disposal (by incineration) and not permitted to enter the sewer system. Because it is a wet area, all electrical outlets should be ground fault interrupted.

3.14 Personnel office and reception area

Guideline 29:

Access to the laboratory animal facility should be controlled and regulated.

It is preferable that all personnel enter or leave the facility via the reception area. This can facilitate visual observation of individuals. The reception area also provides a point for personnel communication and the pick-up and drop-off of inocula and samples. Where this is not practical, other forms of monitoring should be used at remote entries, such as restricted card access and/or cameras interfaced with intercoms.

Offices are required for administrative, senior technical and veterinary staff, and may include space for continuing education materials. A centralized office bank facilitates ongoing communication between the various groups responsible for the effective operation of the animal facility. The centralized office bank may be located outside the facility or at the interface to the animal facility entrance. This may not remove the need for desk space and/or computer space within the facility or specific zones within the facility. Space for the filing and consultation of animal use protocols, SOPs, institutional policies on animal care and use, and animal records must be provided within the facility.

Every effort should be made to provide exterior windows in spaces used solely for human occupancy, keeping in mind security requirements.

3.15 Personnel changing rooms

Guideline 30:

Personnel areas should be designed and strategically located to facilitate and encourage personal hygiene.

Personal hygiene is extremely important to the proper maintenance of a laboratory animal care and use program. Changing into facility clothing and footwear, and where deemed necessary, the use of showers and air showers by investigators and animal care staff, reduces the risk of the mechanical introduction of etiologic agents of diseases. Additionally, showering and changing at the end of the day reduces the risk of taking a zoonotic infection home.

In all cases, special attention to the spatial design and furnishings in changing facilities is important to encourage good practice. Some important considerations include: lockers that are of an appropriate size and well secured; places to sit while changing footwear; showers that are warm and comfortable with shelf space for soaps, antiseptic agents, shampoos, etc.; the option of adequate privacy for changing; and mirrors and shelves for grooming, particularly prior to leaving for the day. Adequate space to put out clean facility clothing and towels should also be included in the design criteria.

3.16 Laundry facilities

The use of in-house laundry facilities will facilitate the frequent laundering required, particularly where commercial laundries do not provide a cost-effective option. Most facilities supply clothing for work within the facility and may require frequent changes between zones within a facility.

3.17 Toilets

Guideline 31:

Each toilet should be enclosed in a separate room with the relative air pressure negative to surrounding areas.

Toilets should be strategically positioned in the different zones of the animal facility, especially where a change of clothes is required when moving from one zone to another. However, in some cases it may not be acceptable to have a toilet in a biocontainment area (for current biocontainment guidelines, see <http://www.inspection.gc.ca/english/sci/lab/convet/convete.shtml>). Each toilet should be housed in an enclosed room with continuous air exhaust. The room should be under strong negative pressure and the make-up air should be drawn from an adjacent change room or corridor. Toilet stalls that are partitioned off a larger room for group use are not acceptable within the confines of an animal facility.

Guideline 32:

Aerosols associated with toilet flushing should be minimized by selection of appropriate equipment and proper placement of exhaust fans.

Standard toilets are effective aerosol producers when flushed, and this, coupled with the tendency to position the exhaust air register in the ceiling, is inadvertently destined to disperse concentrated fecal aerosols throughout the space. Personnel and clean facility clothing can become significantly contaminated if exposed to the generated aerosol. Toilets are available with built-in exhaust at the bowl level to reduce the generation of room aerosols.

3.18 Staff break and meeting room(s)

A staff break room should be provided with adequate space for comfortable seating at tables. In addition, a place for a refrigerator, dishwasher, microwave, and sink, an area for preparing beverages, and access to chilled water should be considered for the break room.

Windows to the outside environment are desirable if the location makes this feasible. Natural light can be directed into enclosed spaces via natural light tubes.

This room may also be useful for staff meetings and as an information centre for staff (which can include books, journals, newsletters, catalogues, notices, etc.).

3.19 Mechanical and electrical space and distribution of services

The mechanical services for an animal facility are extensive and complex because of the need for strict control of environmental parameters and the importance of adequate redundancy. The mechanical space required for a state-of-the-art animal facility is comparatively large, relative to the overall facility, if

compared to a building designed solely for human occupancy.

Guideline 33:

Adequate space must be available to accommodate the mechanical and electrical services and to allow servicing of this equipment.

The central electrical panels and monitoring and communication equipment require dedicated spaces.

Distribution of supply and exhaust air duct work is complex and spatially demanding. In addition, temperature control in the individual animal holding spaces is most frequently achieved by reheat coils on the supply air side. Plumbing distribution is extensive and may include piped gases from a central supply and main line sources. With electrical and electronic communication lines, the distribution space is further challenged.

Guideline 34:

Where possible, mechanical and electrical equipment should be located so that they are accessible from outside animal holding rooms and other critical areas such as surgical and necropsy suites.

Institutional physical plant maintenance personnel should always be represented on the user group team during planning and design to ensure that their required activities are represented and can occur unimpeded with minimum interference to the scientific and animal care occupants of the facility.

Possible locations for the mechanical services are illustrated in Diagram 9. Ideally, the mechanical services are located such that maintenance of the equipment can be achieved without having to enter the animal facility itself, such as in an interstitial or epistitial space. However, this may not be feasible due to the extra size of building

required or limited space within an existing building proposed for renovation. In these cases, it is recommended that the facility be designed so that mechanical services can be maintained from the main corridors without the requirement to enter animal holding rooms, procedure rooms and restricted zones.

3.20 Corridors

Guideline 35:

Corridors must be wide enough and have sufficient protection to permit the largest items of equipment, such as cage racks, to be moved safely without causing damage to the facility or the equipment.

Corridors or hallways should be configured to facilitate the movement of personnel and equipment, such as cage racks. The corridors

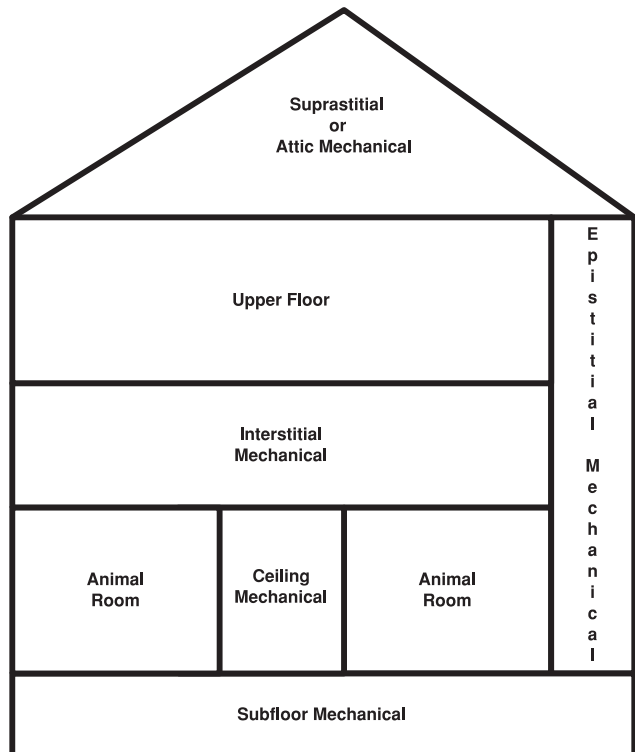

Diagram 9: Possible locations for mechanical services

also need to be cleaned and disinfected at relatively frequent intervals to compensate for the effects of the frequency and source of the traffic.

In particular:

- Corridors should be a minimum of two metres wide (and preferably 2.2 metres in order to give two full metres clearance after bumper rails have been added).
- Walls of corridors should be protected with a bumper or rail that is impact resistant and facilitates thorough cleaning and disinfection. Bumper rails should curve around corners. Bullnosed corners facilitate this feature.
- Curbs may also be used to prevent equipment from damaging wall surfaces.
- Where bottlenecks for equipment may occur, corridors should be increased in width to create marshalling or staging areas that prevent obstruction to traffic during the busy working days.

The flow of traffic in the animal facility is discussed under Section 5. Traffic Flow Patterns. Movement of air along corridors should flow from the cleanest to the dirtiest areas of the facility.

3.21 Barriers

Guideline 36:

Barriers should be strategically located throughout the laboratory animal facility to minimize the potential for cross-contamination and to segregate incompatible activities.

Guideline 37:

Current biosafety guidelines must be consulted in all cases where animals are infected with known human or animal pathogens.

Barriers in the context of animal facility design consist of a combination of physical

systems and performance criteria that together minimize the transfer of etiologic agents of animal or human disease from one side of the barrier to the other. Diagram 10 illustrates some of the potential means for transfer of etiological agents across barriers. The barriers should be designed to reduce the potential of transfer by these means to the extent dictated by the risk and research requirements.

Barriers form an integral part of all animal facilities, and therefore, the basic concepts are described here. However, this discussion is not an alternative to biosafety guidelines describing the facilities and procedures to be used when working with human and/or animal pathogens (i.e. HC and AAFC; see Appendix A).

Barriers may be divided into two categories, namely **inclusion** and **exclusion barriers**.

Inclusion barriers are set up to prevent the escape of agents of disease from the animals in the unit to the outside (**biosafety**). Inclusion barriers may be established to quarantine or isolate animals of unknown health status or to contain animals intentionally infected with human or animal pathogens (**biocontainment**). They may also be used to manage an animal or group of animals in which there is an outbreak or potential for an outbreak of infectious disease that is not a threat to people or biosafety. This comes under the activity of animal isolation and/or quarantine and is relevant to the biosecurity of animals of the same species and others known to be susceptible to the disease.

Exclusion barriers are established to prevent the entry of animal infections and infestations from outside sources (**biosecurity**). Exclusion barriers are often established to protect the health status of laboratory animals such as virus antibody-free rodents, immunocompromised animals and valuable genetically modified animals.

It is important to note that an exclusion barrier keeps things out, but does not prevent infectious material from escaping into the environment. The inclusion barrier is designed to contain infections, but it will do little to

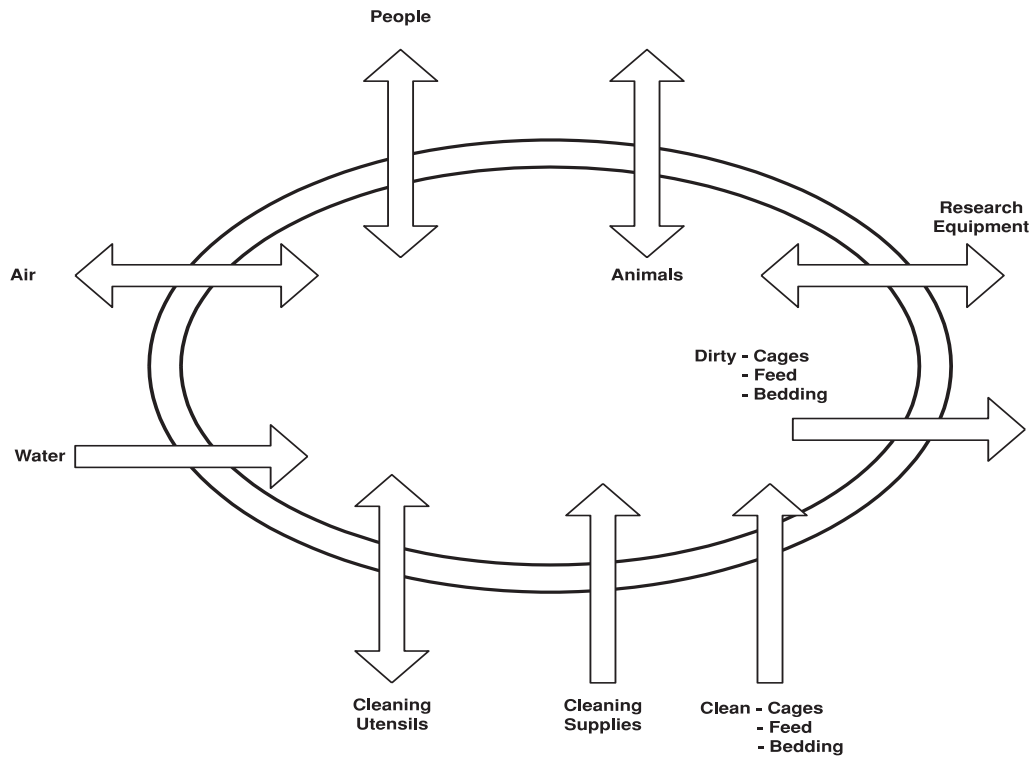

Diagram 10: Barrier challenges

prevent an infectious disease from outside crossing inside the barrier. As a result, it is sometimes necessary to combine features of an exclusion and inclusion barrier. This requires a combination of physical and operational barriers. For example, housing immunocompromised animals challenged with a pathogenic organism would require the use of an inclusion/exclusion barrier.

A barrier can be created at the cage, rack, room, suite or facility level, and combinations of these are used frequently.

Guideline 38:

If an anteroom is to be used as a component of a barrier system, then it must be large enough to accommodate the largest materials that will pass through it such that only one door need be opened at a time.

Components of the animal facility from which barriers can be created are:

- **Doors** with appropriate weather stripping and spring-loaded door sweeps, effectively deployed when the doors are shut, form simple barriers. By introducing operating procedures for changing footwear and donning protective clothing on entering the room and removing it on leaving, a stronger barrier may be created. Interlocking doors at interfaces to various zones permit only one door to be open at a time, thus improving the air barrier between zones of different status.
- **Handsinks**, positioned close to the door of an animal room, should be used on entering and exiting the animal room. The efficacy of handwashing as a simple barrier procedure has been well established.

- **Air locks** may be used as barriers and consist of tightly fitting doors on a pass-through chamber for passing clean or chemically sanitized equipment **into** the barrier facility only.
- **Anterooms** or vestibules to rooms greatly improve the potential to create a simple and effective barrier. The differential air pressures (positive or negative) in the animal room can be maintained more effectively with an anteroom, providing that only one door is open at any one time (see interlocking doors above). The anteroom acts as a simple air lock, preventing the retrograde movement of room air to the corridor or vice-versa, depending on the set differential pressures. The anteroom also provides a halfway stage in and out where extra layers of protective clothing and footwear can be donned or removed. A handwashing sink in the anteroom may further assist in establishing an effective barrier.
- **Change rooms** are components of barrier suites or entire facilities. The change room zone is divided into two spaces, one on the outside of the barrier and one on the inside, usually separated by a shower unit. Clothes are removed in the outside change room and clean (sterilized) clothing and protective clothing (over garments, hats, face masks, gloves, etc.) are available in the inside room. In a complete exclusion barrier unit, the objective is to prevent anything dangerous from entering the area, and therefore, showering-in may be required. Air showers are sometimes used as an alternative to water. In the full inclusion scenario, all clothing must be removed before leaving and individuals must shower-out using appropriate soaps and disinfectants.
- Pass-through **autoclaves** can be installed at the room, suite or facility level as an important tool in establishing an effective inclusion or exclusion barrier. They may be used to sterilize material either into or out of the unit.
- **Fumigation/disinfection chambers**, usually small pass-through rooms, can be

positioned at the barrier and are used to chemically sterilize larger items of equipment safely. The chamber operates at slight negative pressure during the exposure process. A manually activated exhaust fan is used to evacuate the chamber.

- **Disinfectant transfer tanks** (dunk tanks) may be used for the transfer of waterproof objects across barriers by immersion in a disinfectant solution. Dunk tanks contain self-sterilizing liquid but should not be used as the sole means of decontamination.
- Controlled supply and exhaust air is required for the maintenance of **constant air pressure differentials**.
- **High efficiency particulate air (HEPA) filters** can be used as effective barriers to the transfer of airborne disease organisms.

The incorporation of some or all of the above components can be used to establish the physical features of a barrier unit. The final integrity of the unit depends on the protocols for entry and exit of personnel and material, and the differential air pressure determines whether it is an inclusion or exclusion barrier. Diagram 11 illustrates the use of many of the above components to establish a barrier suite.

The relative number of animals maintained within any barrier unit may vary considerably. Therefore, it is extremely useful to incorporate **flexible barriers** into an animal facility such that the relative size of the barrier can be changed according to demand. In Diagram 12, which illustrates a flexible barrier in a U-shaped corridor, the relative size of the barrier suite can be varied from A to C by sealing off the appropriate set of corridor doors. In Diagram 13, which illustrates a flexible barrier in a facility with a double corridor, the relative size of the barrier can be increased or decreased by altering the opening of the room to either the barrier corridor or the conventional corridor, respectively. The ventilation system in flexible barrier systems must be designed (segmented) to accommodate the potential size of the barriers. Where flexible

barriers are constructed, it is essential to ensure effective separation between active barrier and non-active barrier areas.

It is also possible to create temporary and/or portable barriers within existing or new structures with the use of soft wall structures that are supplied with HEPA filtered supply and/or exhaust systems. These types of units, when run under positive pressure, are useful as portable surgical units for research laboratories, as a means of providing an ultra-clean room within conventional facilities for the housing of immunocompromised animals, and for the maintenance of valuable genetically modified animals. They are also effective in the reduction of potential allergens.

Mobile and lightweight air filter power units pass air through HEPA filters. Unfiltered incoming air to a room can be directed to such a power unit using flexible ducting. Depending upon the size of the power unit, air exchanges up to, or in excess of, 100 air changes per hour are usually easy to achieve. Use of this technology with an attached/enclosed laminar flow hood, autoclaved cages, food and bedding, and other accessories, and combined with carefully developed and functional procedures, can provide a high level of ultra-clean housing to animals within such a room unit.

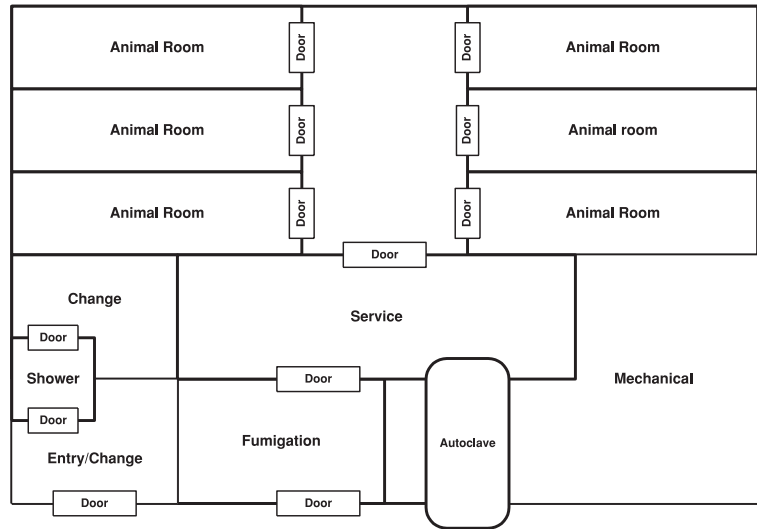

Diagram 11: Barrier system

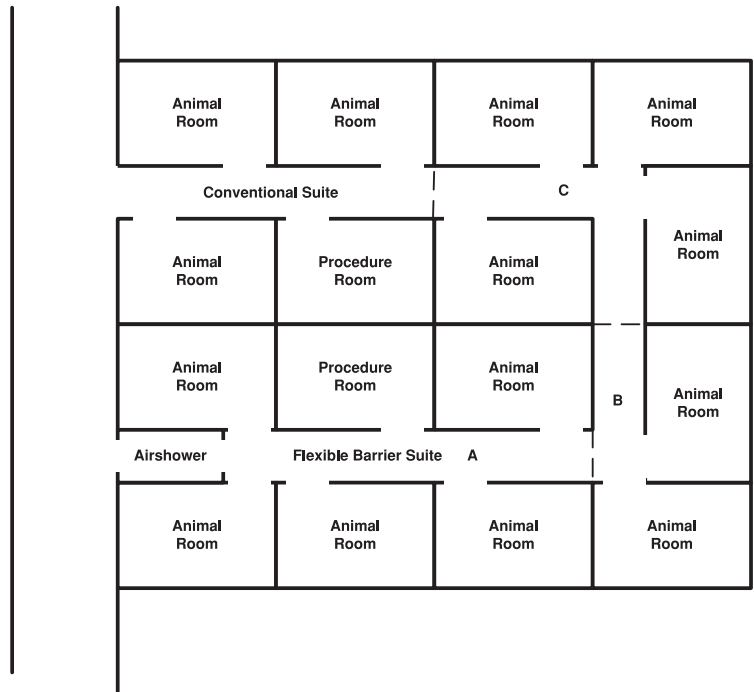

Diagram 12: Flexible barriers — U shaped corridor

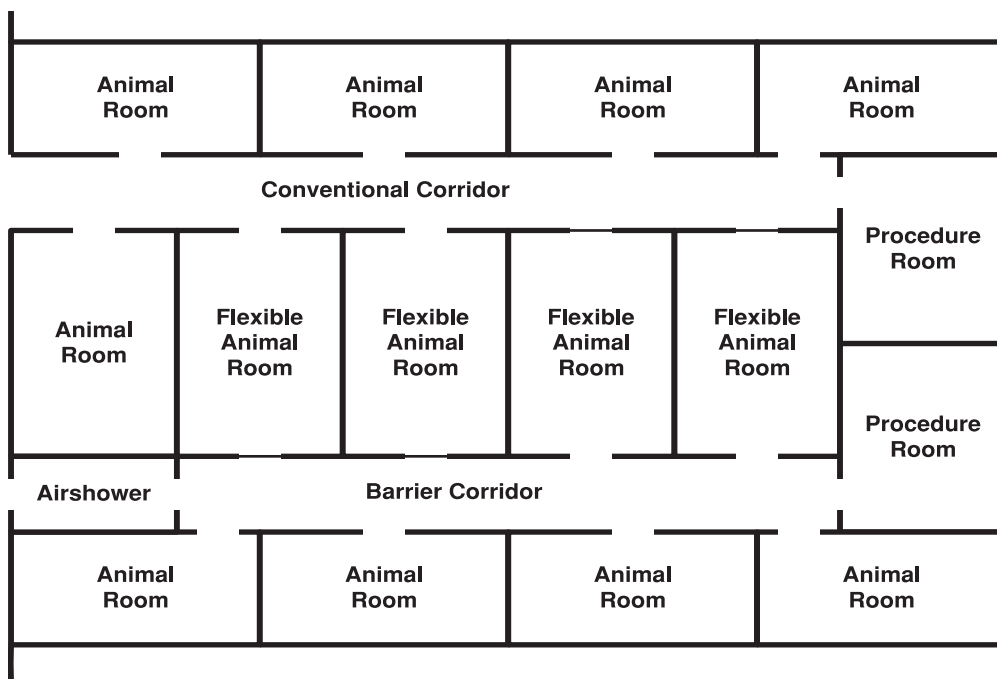

Diagram 13: Flexible barriers — double corridor

This soft plastic wall technology can be used in a variety of configurations:

- 1) **New facilities:** Clear soft-wall clean rooms can be used to create new laboratory animal housing that has barrier level conditions within standard and simplified buildings. These conditions are achieved via mass air displacement through mobile HEPA filters that are combined with stand-alone power units.
- 2) **Building renovations:** Soft-wall clean room partitions can be installed in existing facilities to create barrier-like conditions via mass air HEPA filtration. Existing air sources can be collected and HEPA filtered as well.
- 3) **Portable systems:** It is possible to use various types of portable vinyl dividers and portable mass air HEPA filtration devices to create semipermanent barrier conditions.

The cost of such a set-up is limited to the power/HEPA units, plastic vinyl partitions and supports, flexible ducting and accessory

support equipment. Therefore, costly structural changes to the room(s) and air system upgrades are not required.

3.22 Radiation shielded suites

Guideline 39:

All suites where sources of radiation are to be used must meet current radiation safety guidelines as established by the Canadian Nuclear Safety Commission (CNSC) and must be approved for such use by the local radiation safety officer.

Guideline 40:

The radiation hazard area must be separated from other animal housing and work areas, be clearly identified as a hazard area, and have access restricted to necessary personnel only.

In Canada, laboratory use of radioisotopes is regulated by the Canadian Nuclear Safety

Commission (CNSC) (<http://www.nuclear.safety.gc.ca>). The CNSC issues licenses to institutions for the possession of radioactive materials.

The requirement for shielding depends on the potential of the equipment to create radiation hazards beyond the immediate confines of the room. This must be determined by clear definition of the specifications of the equipment to be located in the room and compliance with regulations and codes.

Examples of equipment requiring shielding that may be used in an animal facility include X-ray apparatus for diagnostic imaging and animal irradiation apparatus involving a radioactive source.

These guidelines do not cover the specifications of rooms suitable to house equipment emitting radiation. **It is absolutely essential that the institutional radiation safety officer or a qualified radiation safety consultant of the institution be involved in the planning, building design specification, construction and commissioning of any component of a proposed animal facility in which any radionuclide or equipment emitting ionizing radiation is to be used. These facilities must meet CNSC requirements for licensing.**

4. Functional Adjacencies

Guideline 41:

The components of an animal facility should be organized according to function and should promote and facilitate biosecurity.

By definition, the laboratory animal facility is a building or part of a building which enables the care and use of experimental animals to be performed effectively and efficiently. The form of the facility should primarily be determined by the sum total of the functions that it must accommodate, the spaces in which those functions will occur and the manner in which those spaces are positioned relative to one another.

This is an idealistic definition since it is not unusual to be presented with an existing building footprint or a floor space of predetermined geometry. In these cases, managing the desired functional relationships within such spaces can become an architectural challenge.

The relationship of the functions to be performed in the component spaces of the facility needs to be developed by teamwork of all individuals involved in using or maintaining these spaces. An example of this could be the need to have procedure rooms in close proximity to the animal holding rooms.

Facility design must permit the logical movement of clean and dirty equipment to minimize the potential for cross-contamination in a practical and effective manner. This, in effect, will result in a biosecure and efficient operation.

The components of the animal facility should be organized according to their functional relationships and desirable traffic flows whenever possible (see Section C.5. Traffic Flow Patterns).

Examples of the functional adjacencies of animal facility components are given in the following sections (4.1 to 4.13).

4.1 Personnel facilities

Guideline 42:

The reception area should be located near the main personnel entrance to the facility.

Guideline 43:

Change and shower facilities should be located near the personnel entrance to the facility and, if required, at the transition area between zones within the facility.

Guideline 44:

Toilets may be placed within barrier units so that personnel do not have to go through a complete change of clothes every time they visit the washroom. For biocontainment facilities, current biocon-

tainment guidelines should be consulted to determine the acceptability of wash-rooms within facilities.

Guideline 45:

The staff break room should be located at the perimeter of the facility and close to the personnel entrance and changing and shower facilities.

Changing and shower facilities should be located near the entry to the facility (see Diagram 14) and also at the transition zone to specific barriers within the facility. It is recommended that everyone entering or exiting the facility beyond the reception area must

pass through the change and personal hygiene facilities to ensure established SOPs for biosecurity and biosafety can be consistently maintained and monitored. Where inclusion or exclusion barriers are maintained as a specific zone within the animal facility, appropriate changing and showering facilities may also be required at the periphery of these zones. They are often incorporated into the barrier such that personnel are forced to go through the change room and/or shower in order to enter the next area.

Locating the office area for administrative, senior technical and veterinary staff of the animal facility adjacent to the reception area has been found to be useful. This area is often located near the main entrance to the facility to facilitate the receipt of materials. However, it may be preferable to locate it in an alternative area if the entrance to the animal facility does not provide the best environment for personnel (e.g., lack of access to daylight).

The staff break room should be located at the perimeter of the facility and close to the changing and shower facilities. In this location, it may be accessed from either outside or inside the perimeter but not both, depending on management preference. If it must be within the facility, food and beverages should be restricted to this room. It may also be effective to have the break room located near the administrative offices if these are not integral to the animal facility, as discussed above.

In some cases, it may be necessary to have separate break rooms for different zones within the facility.

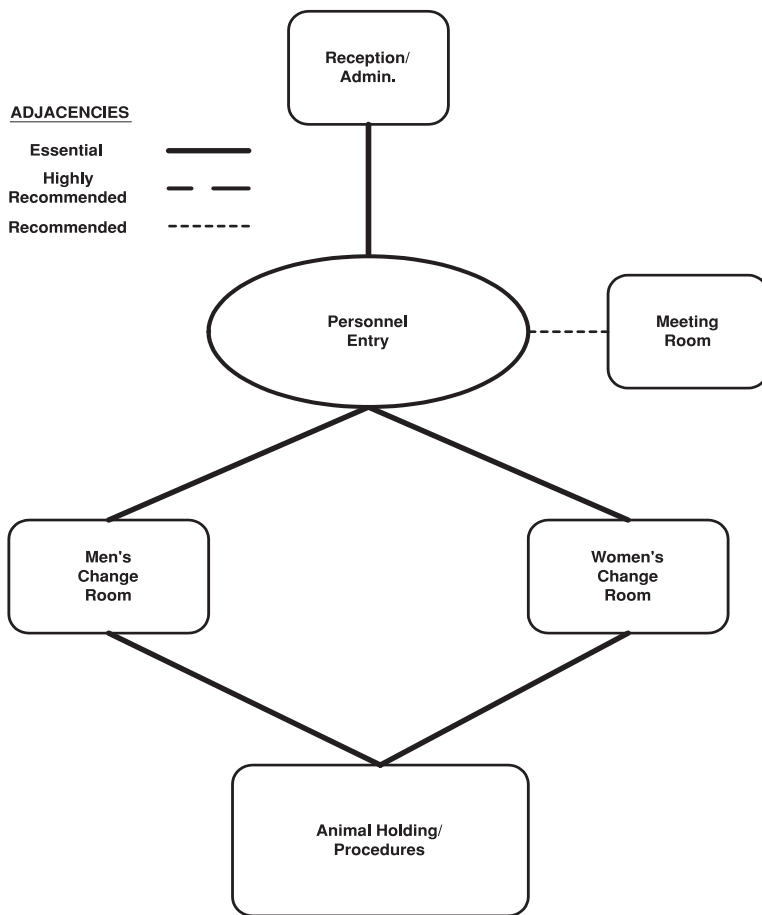

Diagram 14: Functional adjacencies — entrance

However, experience has shown that in the majority of animal facilities, the break room can be positioned so that it is available to most personnel using appropriate access protocols. The break room may be positioned effectively in close proximity to the change area and central for the majority of people.

4.2 Animal holding rooms

Guideline 46:

The cleanest animals in the facility should be easily serviced from the clean side of the cagewash or clean cage storage areas, while rooms holding the dirtiest animals in

the facility should have good access to the dirty side of the cagewash area.

It is critical that traffic flow patterns be considered when deciding on the location of the animal holding rooms and their potential use. The animal holding rooms should be located so that there is relatively easy access to both the dirty side of the cage washer and clean cage storage. The animals that are considered the dirtiest, such as random source animals, should be housed as close as possible to the dirty side of the cage washer. Similarly, the isolation room for sick animals should be close to the dirty side of the cage washer and autoclave. Cleaner animals may be located

farther away from the dirty side and closer to the clean side of the cage washer. Projects that require frequent access by investigators are often best located near the entry to the facility. Quarantine rooms should be located near the dirty loading dock. Examples of animal holding room functional adjacencies are given in Diagram 15.

4.3 Procedure rooms

Guideline 47:

Procedure rooms should be located as close as possible to the animal holding rooms they will serve.

The procedure rooms within the facility should be adjacent to the animal holding rooms and can actually be incorporated into anterooms for one or several holding rooms, as previously discussed (see Diagram 15). Animal laboratories outside of the animal facility should be

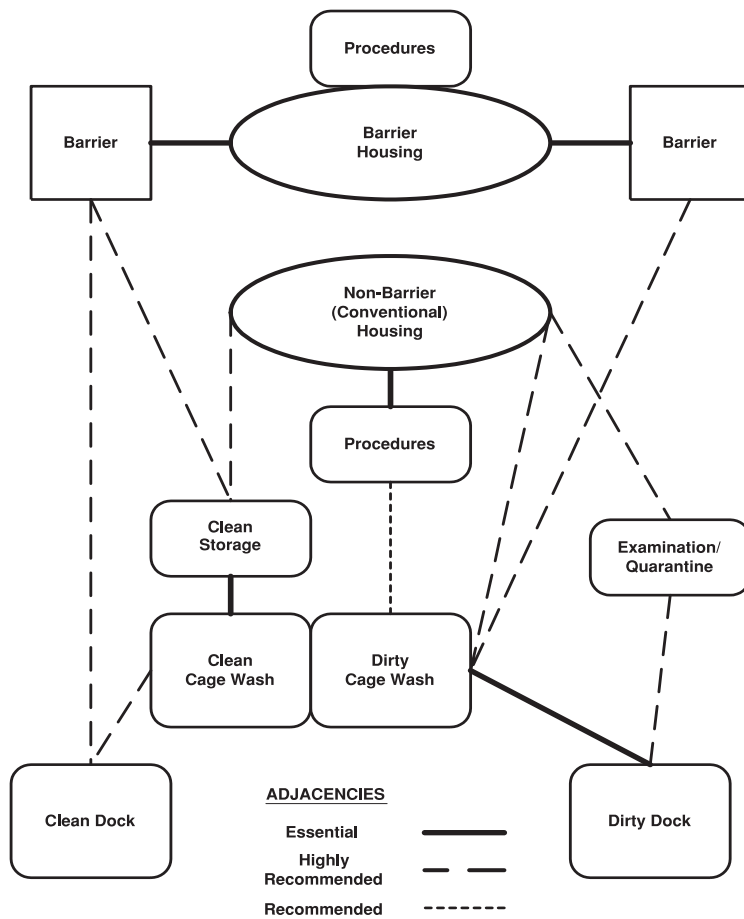

Diagram 15: Functional adjacencies — animal holding

located as close as possible to the facility so that animals do not have to be transported long distances through routes of access shared by unassociated institutional personnel or members of the general public.

4.3.1 Laboratory animal allergy and animals in laboratory settings

Laboratory animal allergy (LAA) is a major concern for the occupational health and safety of those exposed to laboratory animals (Wolfe & Bush, 2001). Exposure to laboratory animal allergens by persons outside the animal facilities who are unaware of exposure is particularly serious, especially in health care settings.

Because of this emerging concern, it is recommended that the planning and design of animal facilities take into account the movement of animals and associated material to and from the laboratories, developing an integrated overall plan to minimize the hazards posed by laboratory animal allergens.

Movement of animals throughout the facility should be minimized. If transport is necessary, the animals should be placed in clean, covered, and preferably ventilated carriers that contain fresh bedding.

Animals should be maintained and manipulated in a negatively ventilated environment in the laboratory (Harrison, 2001). However, animals should never be housed in chemical hoods.

4.4 Surgical suite

The surgical suite should be located so that animals can be moved back and forth between the animal holding rooms and the surgical suite while minimizing the potential for dis-

ease transmission. It must be easily accessible to personnel who will be working in the suite. Sterile supplies and equipment should be readily accessible to the surgical suite (see Diagram 16).

4.5 Cage and equipment washing and sterilization

Guideline 48:

The clean side of the cagewash area should be linked to the clean loading dock, bedding storage area, and clean cage and equipment storage area. There should also be clean access back to the animal holding rooms. The dirty side of the cagewash area

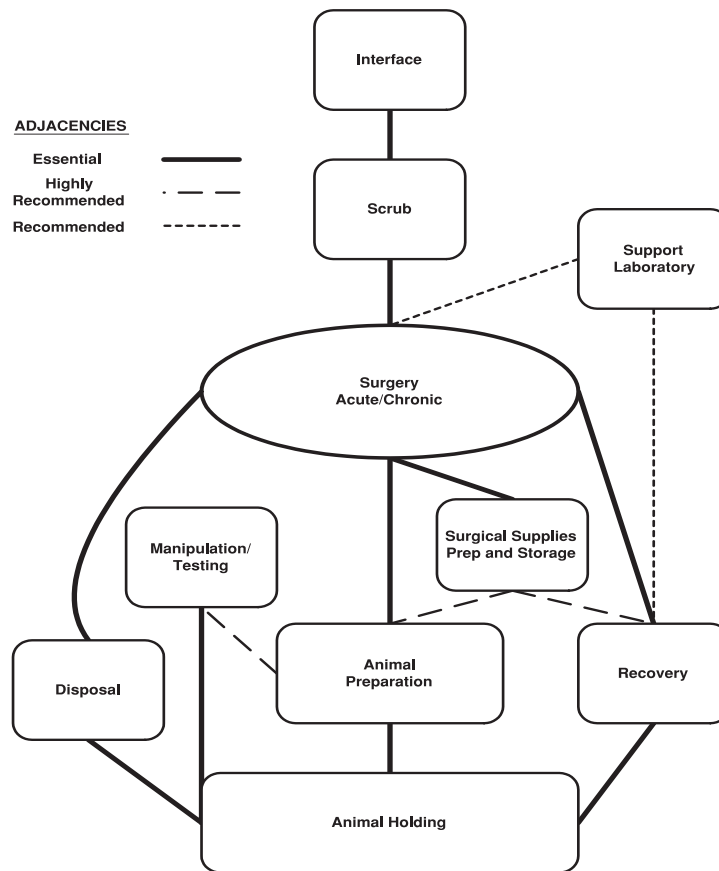

Diagram 16: Functional adjacencies — surgery suite

should be closely linked to the waste storage area and the dirty dock. Access from the animal holding rooms to the dirty side of the cage washer is also required.

Examples of functional adjacencies for the cagewash component are illustrated in Diagram 17.

4.6 Clean cage and equipment storage

Guideline 49:

The clean cage and equipment storage area should be located near the clean side

of the cage washer and the clean bedding storage area. There must be clean access from the clean storage area to the animal holding rooms and to most of the procedure rooms.

Examples of functional adjacencies for clean cage and equipment storage are illustrated in Diagram 17.

4.7 Clean and dirty loading docks

Guideline 50:

The loading dock(s) must open to the outside of the facility. The clean dock or port should have access to the clean animal reception area and the clean feed and bedding storage area. The dirty dock or port should be readily accessible to the waste storage area.

Examples of functional adjacencies for the clean and dirty docks are given in Diagrams 18 and 19, respectively.

4.8 Animal reception area(s)

Guideline 51:

The clean animal reception area should be adjacent to the clean dock. The dirty animal reception area, if required, should be adjacent to the dirty dock.

Animals that are clean or deemed disease-free can be received from the clean dock and then enter the adjacent animal receiving room (see Diagram 18). Depending upon the management preference, animals may then be un-

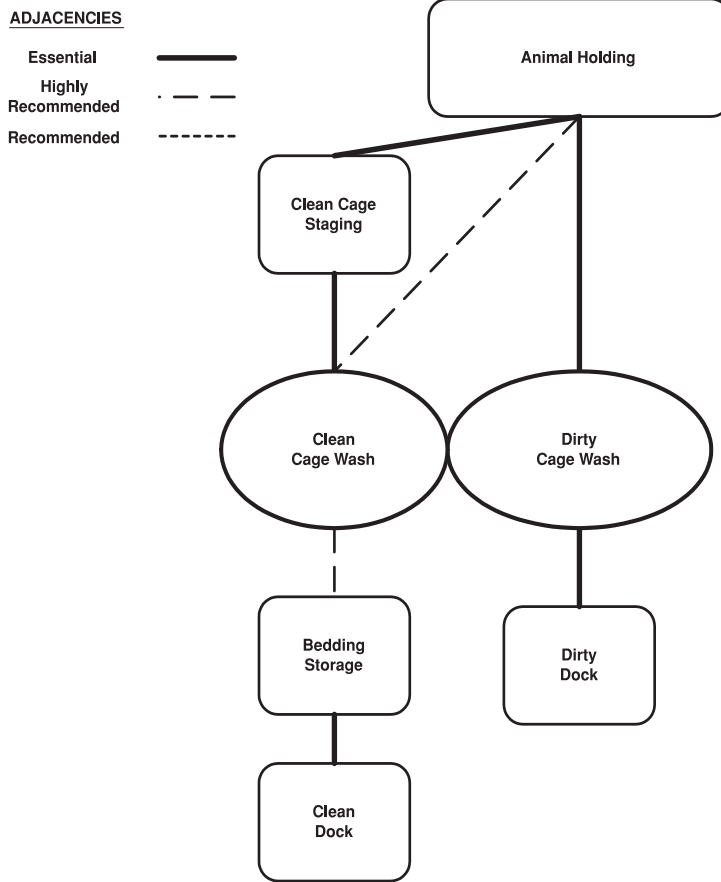

Diagram 17: Functional adjacencies — cagewash

packed and caged in the receiving room using a positively ventilated HEPA filtered air cabinet, or the boxes may be sprayed with disinfectant and then taken to animal holding for unpacking. In either case, the function is designated as a clean one.

Certain animals are deemed 'dirty', such as random source dogs and cats or captive wild species such as woodchucks, raccoons, skunks, etc. Animals of this type must be received at the dirty dock (see Diagram 19) and then transported immediately to the designated holding or quarantine and conditioning suite (an inclusion barrier).

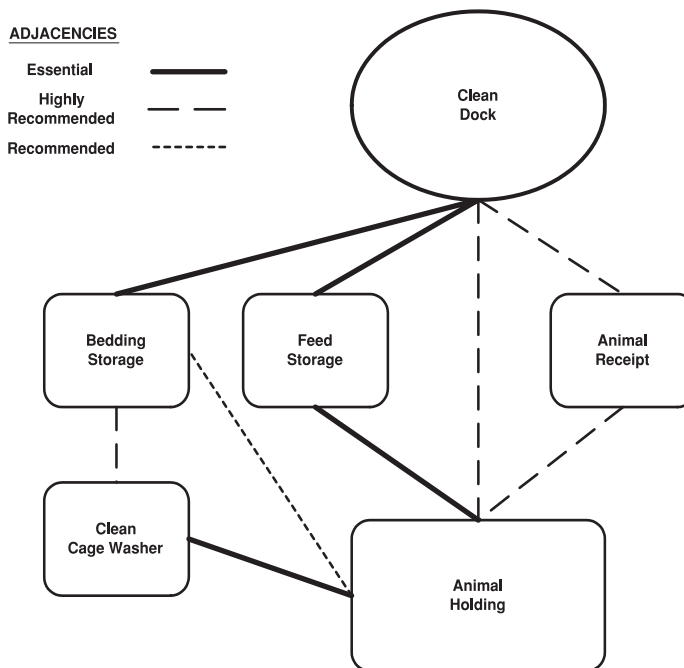

Diagram 18: Functional adjacencies — clean dock

4.9 Feed and bedding storage

Guideline 52:

The feed storage area must be accessible from a clean receiving area and from the animal holding rooms.

Guideline 53:

The bedding storage area must be accessible from a clean receiving area and the clean side of the cagewash area, unless the bedding is to be transferred to the cagewash area via a vacuum system.

The functional adjacencies for feed and bedding are illustrated in Diagram 18.

4.10 Waste storage

Guideline 54:

The waste storage area should be easily accessible from the dirty side of the cagewash area.

Preferably, waste storage should be located outside of the main core of the animal facility. It should also be closely linked with the dirty

loading dock. This may differ if transfer occurs via a vacuum conveyor.

Examples of functional adjacencies for the cage washer, waste storage and dirty dock components are illustrated in Diagram 19.

4.11 Necropsy area

Guideline 55:

Necropsy is considered a potentially 'dirty' function and, therefore, should be located near other dirty functions in the facility, such as waste storage and disposal (e.g., incineration or hydrolysis).

Examples of functional adjacencies for the necropsy area are illustrated in Diagram 19.

4.12 Mechanical services

Guideline 56:

The placement of mechanical systems should be such that servicing has a mini-

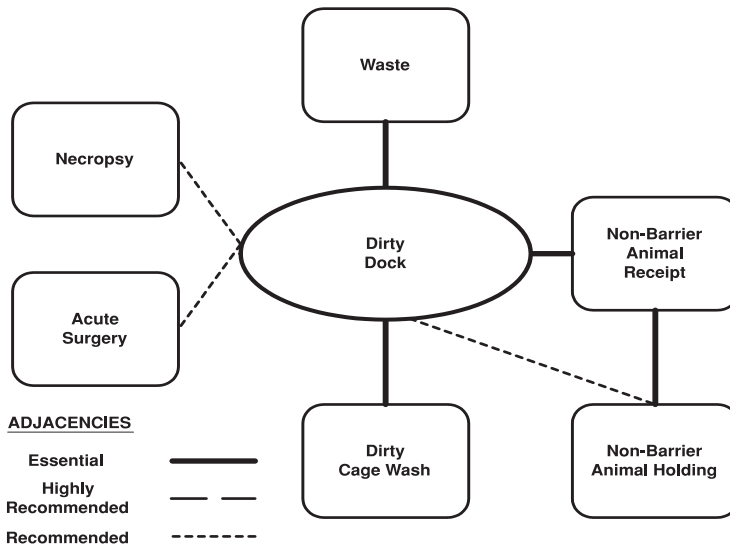

Diagram 19: Functional adjacencies — dirty dock

mal impact on the facility’s environment. Where possible, mechanical systems should be located so that they can be serviced from areas separate from the animal holding and manipulation rooms.

Early in the planning process, careful review of the putative spatial requirements for the mechanical and electrical equipment and the entire distribution system is recommended. This is of vital importance where the animal facility is to be located on designated floors of a laboratory building under development or will be a renovation of existing space.

Accessibility for servicing and repair of the distribution systems in the animal facility can be problematic. Diagram 9 illustrates potential locations for mechanical services. Ideally, utility service corridors, such as interstitial or epistitial spaces, can be utilized to facilitate well-organized distribution systems and good service and repair access. Distribution systems within the ceiling spaces of corridors can provide an adequate design solution for distribution, particularly where floor-to-ceiling height is substantial. Access, however, invariably requires service and repair personnel to enter the facility which, even when well man-

aged, is neither ideal for the service personnel nor the scientific and animal care staff. Interstitial space, or attic or suprastitial space in single-story buildings, offers many design and operation advantages: it provides separate access for service and repair personnel; it affords ease of access to the equipment for servicing (e.g., reheat boxes, dampers, air filtration system, etc., and all the distribution lines, conduit and piping); and it can also provide opportunities to access lighting from above without disturbing the integrity of the rooms below.

Some components, such as pumps and fans, are quite noisy and are often associated with a significant amount of vibration. All of this type of equipment should be located outside of the facility when possible, with sound and vibration attenuation. Ideally, all servicing of equipment should be from outside the facility, and especially outside barrier facilities or suites. This can be accomplished by placing mechanical services on a separate floor adjacent to the animal facility or by the use of service corridors. Where space restrictions require the mechanical distribution systems to be located above the ceiling, access for servicing should be made possible from the corridor and not from the animal or experimental rooms. The cagewash area should be designed so the cage washer and the autoclave, if present, can be serviced from the dirty side. In biocontainment facilities, the body of the autoclave should be on the clean (uncontaminated) side of the barrier.

4.13 Corridors

Guideline 57:

Corridors must be strategically located so that they interconnect the various components of the animal facility and enhance efficient traffic flow patterns.

Corridors are an extremely important component of an animal facility. They not only facilitate movement, but can also be used to regulate traffic flow, depending on location and access.

5. Traffic Flow Patterns

Guideline 58:

Traffic flow within an animal facility should progress from the cleanest to the dirtiest parts of the facility.

Once the components of the animal facility are assembled according to their functional adjacencies, the rudiments of the complete and integrated whole should start to fall into place. At this point, it becomes necessary to develop concepts of movement from one point to another in a logical way (see Appendix D). Generally, the logic is based on a progressive movement from the cleanest areas (less potential of microbial contamination) of the facility to the dirtiest areas (greater potential of microbial contamination). This principle applies to the movement of people, equipment, material and food, as well as to the movement of air.

Historically, the clean and dirty corridor system demonstrated a clear expression of this

concept (see Diagram 20). Only clean materials, equipment and people can be taken to the animal holding rooms via a clean corridor. Dirty material is passed through a second door at the other end of the animal holding room into a dirty corridor to be taken for cleaning or appropriate disposal. Only designated personnel are permitted in the dirty corridor and nowhere else, unless they thoroughly decontaminate and change clothing. This system is still used in certain situations. It is extravagant on floor space, however, because of the duplication of corridors that offer limited versatility for use. It also often requires more personnel and strict SOPs to be functional. The system usually needs strong justification.

It has become more acceptable in many instances to use a unidirectional flow pattern in combination with limited bidirectional flow. Diagram 21 illustrates possible traffic flow patterns in a conceptual animal facility. In this scenario, the traffic moves in a circle wherever possible. Clean people, equipment and food flow in a single direction.

Soiled material for cleaning and/or disposal follows a similar direction to the more soiled areas of the facility, such as the dirty side of the cagewash. Where bidirectional flow is required, these areas are maintained meticu-

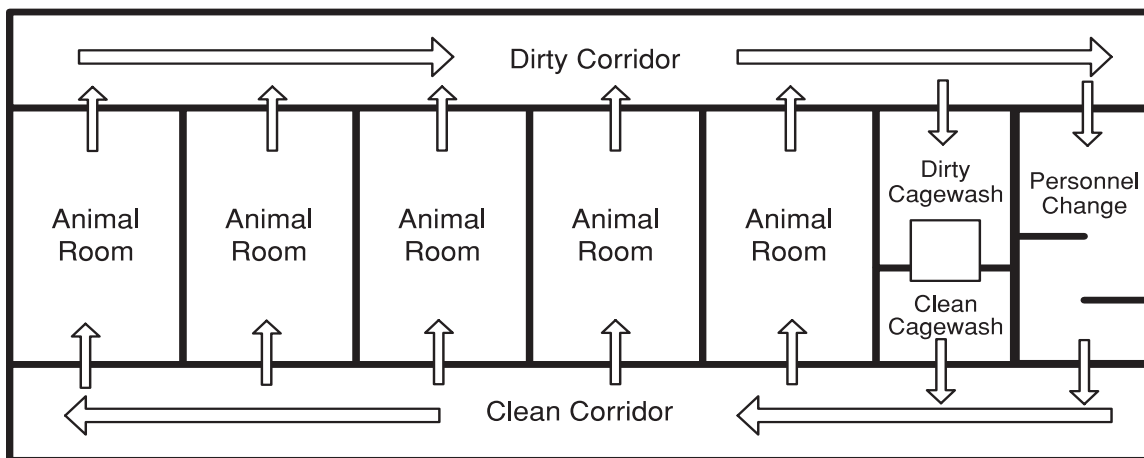

Diagram 20: Clean/dirty corridor system

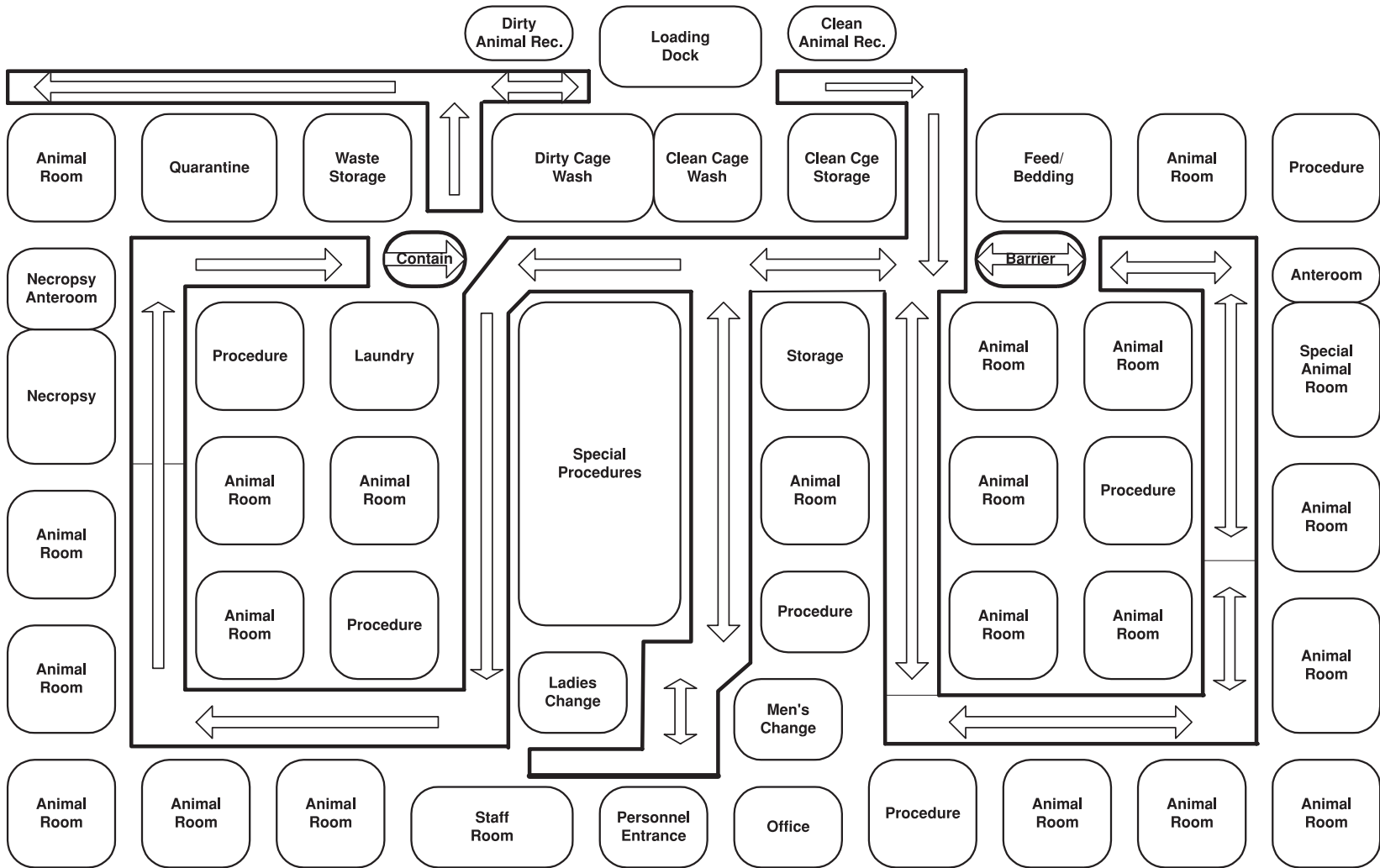

Diagram 21: Traffic flow in a conceptual animal facility

lously clean. This system requires careful attention to effective SOPs for the movement of personnel and equipment. Both clean and dirty items of equipment are containerized or effectively covered for transportation around the facility. Personnel don appropriate protective overgarments for each animal holding area according to formally established procedures.

Anterooms greatly improve the segregation of animal holding rooms, as discussed previously under Section 3.21 (Barriers) and elsewhere, and they complement the effective operation of bidirectional flow patterns extremely well.

6. Materials and Finishes

The first general guideline of a laboratory animal facility (see General Guideline A) emphasizes the need for all components, including materials and finishes, to be designed to facilitate the sanitation processes.

Guideline 59:

Materials and finishes should be durable, impervious and resistant to water and chemicals used in their sanitation. In addition, they must be resistant to damage by equipment used in the facility, such as cage racks, or they must be protected from damage. Ledges, crevices, cracks and unsealed service penetrations that can harbor dirt and vermin should be eliminated wherever possible, and all hollow doors must be filled or completely sealed.

6.1 Walls

Walls should be covered with an impervious coating that withstands frequent cleaning and chemical disinfectants. An epoxy coating is frequently applied. The walls should be free of cracks, and all pipe and service sleeves should be sealed to exclude vermin. For ease of cleaning, the walls should be seamless and the floor coved to the walls.

The most common substrates for walls are concrete block and drywall. When using concrete blocks, a medium weight should be used to achieve a dense smooth block face. Low-density blocks are difficult to seal and leave small pores which are difficult to clean. Shallow concave mortar joints should be used for ease of cleaning. The concrete blocks can be filled with sand to improve sound attenuation (these are strongly recommended for primate and dog rooms). For walls that are not easily sealed, fiberglass reinforced plastic panels can be used to produce an effective wall covering for animal facilities.

Metal framing should be used with drywall. Wood framing members are unsuitable for animal facility construction. The drywall used should be moisture resistant and fire rated. All seams must be well sealed. There should be a smooth juncture between the wall and the upper edge of the integral cove base (i.e. no ledge).

Corridor walls are especially prone to damage due to the movement of carts, cage racks, etc. Therefore, it is usually necessary to protect the walls and corners with some form of bumper guards or protective shields. These are available in many materials, such as plastic, stainless steel and aluminum. Care should be taken when selecting bumper guards to ensure that they can be easily and thoroughly cleaned and that they cannot harbor vermin.

6.2 Floors

The base floor for animal facilities should be concrete slab. The expansion joints in the concrete should be located under walls wherever possible. The quality of workmanship is critical to the function and durability of the floor.

Seamless epoxy flooring with integral cove base is the most common flooring used, especially in animal rooms. It is durable, impervious to many chemicals and solvent-based products and easily cleaned. It can be made less slippery by adding grit to the surface; however, care must be taken not to make the surface too rough since this will reduce the lifespan of the floor and make sanitation more

difficult. Toxic fumes are released during installation and repair, and evacuation of the area during the repair process is advised.

Methyl methacrylate is often used as an alternative to epoxy due to its quick curing time and the reduced time of exposure to toxic fumes.

Sheet vinyl with heat or chemically-welded seams is being used more often in animal facilities, especially in corridors. It is available with an integral cove base, is comfortable to walk on, can be obtained with non-slip capability, and reduces noise levels. However, it tends to stain and mark more easily than epoxy. It is easily and effectively repaired if damaged. The process does not produce toxic vapors and, therefore, does not require evacuation of the area. Certain sheet vinyl products are available with built-in antibacterial properties.

A sealed or painted concrete floor generally does not stand-up well, requires frequent refinishing and does not provide a non-slip surface. In addition, the rubber or vinyl cove bases often associated with these types of finishes may provide a refuge for vermin.

All other floor types should be investigated closely and, if possible, tested before using extensively in a facility. Review of installations in other animal facilities is also recommended.

6.3 Ceilings

As with floors and walls, ceilings must be resistant to frequent washing and disinfection; however, they are not subject to the same wear and tear. The preferred substrate for ceilings is moisture resistant drywall that is well sealed at all ceiling-wall joints and penetrations. It should be coated with a two-stage epoxy finish or a high-quality enamel paint. It is easier to patch enamel if required, but overall, it is demonstrably less durable. A seamless ceiling should be provided in all animal holding and procedure rooms.

It is often necessary to have access to the mechanical and electrical services which run in the space between the ceiling and the roof

or the floor above. It is recommended that these services be located above hallways, rather than in animal rooms, whenever possible. A T-bar ceiling can be used to permit access to the services. The suspension framing is often subject to corrosion from high moisture levels and hence reinforced plastic, aluminum or stainless steel should be considered. The panels should be easily cleaned (smooth-surfaced vinyl-coated drywall panels work well). Lighter panels should be kept in place with clips to improve the seal between the panels and the frame. The use of the underside of concrete slabs as ceilings with no subceiling is not recommended; it may be difficult to clean and the exposed pipes and mechanical services tend to collect dust. These ceilings may also be subject to corrosion from high moisture levels. At a minimum, concrete must be sealed with purpose-made products to prevent the continuous surface erosion and dust formation.

6.4 Doors

Doors in animal facilities must be capable of taking considerable abuse. Top quality products and workmanship should be used. The doors and frames should be made of a durable metal and be completely sealed or filled with foam to prevent access to vermin such as cockroaches. The frames should fit within the wall space, rather than overlapping, so that there are no ledges to collect dust. The doors should be large enough to accommodate the movement of all required materials, such as cage racks. The minimum sizes are 120 cm nominal opening for a single door and 180 cm nominal opening for a double door. In order to protect the doors from damage, it is often necessary to cover at least the lower half with sheet stainless steel, aluminum or plastic. Bumper guardrails may also be required on more vulnerable doors. A door sweep should be installed on the base of the door if the clearance exceeds 3.2 mm.

Windows in the doors are extremely useful to allow observation into rooms and as a safety feature. The windows on animal holding room doors do not have to be large (e.g., 15 x 20 cm). It is necessary to be able to close the

window to external light or movement as required; however, if a screening device is incorporated into the door structure, it should be well sealed so that it does not harbor vermin. Opaque magnetic sheets can be used effectively to occlude small windows on animal holding room doors. Larger windows in doors have also been used successfully. Where animal rooms or procedure rooms are small, they help make the space less claustrophobic. Larger windows can be temporarily blocked out with caulked plastic laminate when necessary.

Guideline 60:

The direction in which doors swing should be such that they are safe, do not impede traffic flow and complement the control of airflow where required.

There are many criteria that must be taken into consideration when deciding which way a door should open. These criteria need to be evaluated and used in the final decision, realizing that in many cases it is impossible to satisfy all the criteria. The swing of doors should be such that they cause the least interference with movement and transport. Generally, the doors should swing into a room, rather than out into a hall or corridor. However, if there is limited traffic within a corridor, or doors will be opened infrequently, opening the door(s) into the corridor may allow more efficient use of space within a room or anteroom. Doors in relatively close proximity, such as those in an anteroom, should both swing in the same direction or if necessary out from the anteroom such that only one door need be opened at a time. Interlocking doors are often useful to ensure that only one door is opened at a time. In order for self-closing doors to work effectively, it is usually necessary for them to close in the direction of airflow. However, doors in a biocontainment facility, particularly between areas of different status or pressure, should open with the airflow (and close against it). This prevents aerosols and/or contaminants from being dragged from contaminated to clean areas by the vacuum created by opening the door. This is also

the direction of swing that will have the least effect on the airflow patterns. The effective function and safe use of a door should dictate its direction of swing, which in turn may require compensating mechanical devices to make them work effectively (e.g., stronger self-locking devices, interlocking doors and warning lights). If the animal facility will be used by a large number of investigators, the doors should have locks that can be individually keyed, keypads, proximity reader access control, or similar devices.

6.5 Windows

Although natural sunlight is beneficial to humans and animals, windows are not recommended in most cases for animal holding rooms due to the difficulty they pose in controlling internal environments and to security concerns. Temperature fluctuations due to radiation, conduction and convection can be quite extreme. Windows may be incorporated into outside corridors or staff rooms, provided that all security concerns are met and that windows are well sealed. Interior windows between rooms or between rooms and corridors often open up an enclosed space and give a more open feeling. They are often useful in staff areas and surgical suites to maximize visual communication. Non-breakable windows with metal frames are recommended. The frames should be flush with the walls or recessed.

6.6 Cabinets and other fixed equipment

Guideline 61:

Cabinetry in an animal holding room should be limited to that which is essential for the proper functioning of the room.

Only essential equipment should be built into animal holding rooms since the more equipment, the more difficult it is to clean and the greater the potential for harboring unused supplies and vermin. Cabinets and sinks should be well sealed to the walls.

Stainless steel is very durable, resistant to most chemicals and easily cleaned, and hence, the most often recommended material for animal facilities. Some epoxy-coated metal or plastic finishes may be acceptable, but these should be thoroughly investigated, and where possible, tested before using throughout the facility.

Mobile stainless steel equipment that can be removed and thoroughly sanitized between projects should be seriously considered as this enhances the versatility of space utilization.

7. Plumbing

Guideline 62:

Potable water must be available within the animal facility for both animal and human consumption. Water should be of a consistently high quality so that it does not affect research results.

Guideline 63:

Ample hot and cold water must be available throughout the facility for sanitation purposes.

Guideline 64:

Water must be available for all safety equipment, such as eyewash stations, emergency showers and fire sprinkler systems.

Guideline 65:

Sinks, showers and toilets must be strategically located to accommodate good personal hygiene and to minimize the potential for contamination.

Guideline 66:

Drains must be strategically located in areas where water may be used extensively for cleaning. Drains that are not used on a daily basis should be sealed when not in use or equipped with manual or automatic flushing systems.

Guideline 67:

Laboratory biosafety guidelines should be consulted to determine whether effluent treatment is required.

7.1 Drinking water

Standards for the quality of drinking water for laboratory animals have not been subject to the same stringent requirements as those for defining laboratory animal diets. However, the principle of ensuring potable water, with minimization of variables in its analysis, has been accepted for many years. The inorganic and organic chemical content of potable water varies significantly in different geographic locations, creating inevitable variables from region to region.

Historically, the principal concern with drinking water for laboratory animals was the control of the growth of potentially harmful bacteria. Inhibition of bacterial growth was effected by the addition of chlorine to the drinking water or acidification of the pH to between 2.6 and 3.0. The addition of chlorine to drinking water will produce trihalomethanes from the interaction with methane groups from natural organic materials. Some of this group of chemicals (e.g., chloroform) may exist in biologically significant levels, and vary depending upon the time of the year (e.g., spring run-off). Subsequently, concerns regarding heavy metal, herbicide and pesticide residues became significant issues.

When designing a new animal facility or retrofitting established ones, water quality is one of the major criteria which will contribute to good research and testing practices. Water treatment systems currently include prefiltration, ion exchange systems, ultraviolet irradiation, ultrafiltration (0.5 microns), and reverse osmosis.

The prevalent, and probably the most consistently effective method of providing quality drinking water for laboratory animals, is reverse osmosis with appropriate pretreatment for the feed-water as recommended by the equipment supplier following feed-water analysis.

In reverse osmosis (RO), water is forced by pressure through a semipermeable membrane. The process is therefore the opposite, or the reverse, of natural osmosis in that water flows from a more concentrated solution, through the semipermeable membrane, to a less concentrated solution. The appropriate pretreatment of the feed-water recommended by the supplier gives the maximum duration of use of the semipermeable membrane. RO systems are recommended for use with automatic watering systems. In calculating predicted water utilization with RO, the purified water or recovery of permeate is approximately 33 to 50% and the remainder is discarded.

7.2 Animal holding rooms

Guideline 68:

All animal holding rooms and/or their associated anterooms should have a hand washing sink, preferably located near the door.

Every animal holding room should be supplied with hot and cold water and a sink, preferably stainless steel, for washing hands. The sink water controls should be automatic or wrist, foot or knee activated. The sink should be located relatively close to the door to allow hand cleaning upon entry and exit. The drains for these sinks must be sealed such that waste water cannot be aerosolized into the animal room. It is advisable to have a hose connection as well, especially in large animal holding rooms. There are good built-in hose bibs specifically designed for animal facilities (see Diagram 22).

Guideline 69:

Floor drains should be strategically located and designed so that they can be sealed when not in use or easily flushed to maintain an effective water trap.

Floor drains are required in large animal rooms and should be a minimum of 15 cm in diameter and contain flush systems. These may be incorporated with floor trenches,

depending on the method used for housing the larger animals. Floor drains are not required in rodent holding rooms, although they may be useful during major clean-ups between groups of animals. If floor drains are used in the rodent rooms or in corridors, they should be a minimum of 10 cm in diameter and incorporate running traps with cold water primer lines or a manual (see Diagram 23) or automatic flushing system. All floor drains should be designed to prevent back-flow.

All floors should slope towards the drain. Where floors are flat (e.g., in rodent rooms to keep the racks level), the area surrounding the floor drain should be dished to facilitate the capture of water moved towards it.

7.3 Procedure rooms

Animal preparation areas, surgical suites, necropsy areas and other unique areas will require plumbing specific to the equipment used. Consultation with the supplier of the equipment prior to installation of the rough plumbing is recommended. The faucets for hand wash sinks in these areas should be

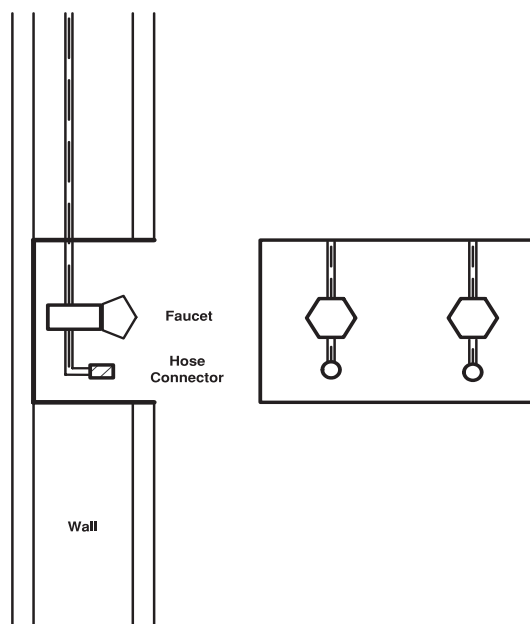

Diagram 22: Recessed hose bib detail

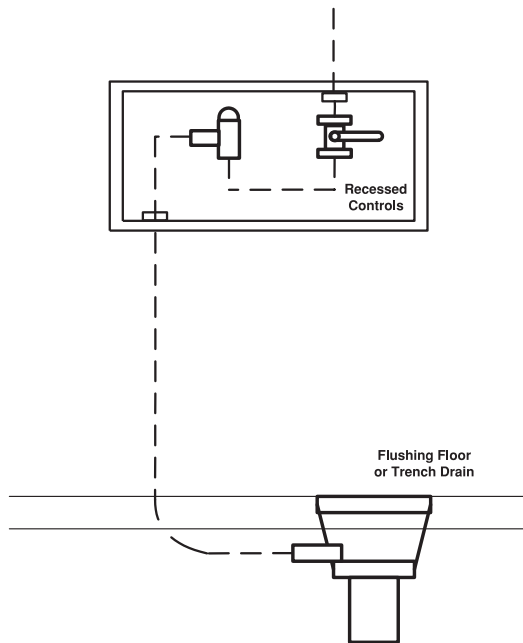

Diagram 23: Flushing drain pipe

designed to minimize cross-contamination. When functioning properly, faucets that are activated by an infrared eye are ideal.

7.4 Personnel areas

Washrooms and showers should be well designed, sufficiently large and easy to sanitize. Sinks should be included in the staff rooms and washrooms, and automatic or wrist or knee activated faucets should be used wherever possible.

7.5 Cagewash and sterilization areas

The cage washer, bottle washer, sipper tube washers, autoclaves, etc. have unique plumbing requirements that must be designed in consultation with the supplier of the equipment.

Large double sinks are often included on the dirty side of the cagewash area for the disposal of urine and the rinsing of cages.

It may also be necessary to have a very well drained bay or alcove for hosing down large

pieces of equipment that will not fit in the cage washer or require a preparatory pre-rinse.

8. Electrical

8.1 Electrical outlets

Guideline 70:

All electrical outlets in animal rooms and in other areas where they may be exposed to water must have a ground fault interrupter (GFI) and be fitted with an all-weather cover.

Guideline 71:

If there is the possibility of using ventilated cage systems, change hoods or other electrical equipment in an animal room, this should be taken into consideration when planning the location and distribution of power to the room.

Guideline 72:

All electrical conduits through walls must be completely sealed to eliminate their potential use as routes for vermin or aerosols.

At least one electrical outlet is required in each animal room. These outlets must be located so they are easily accessible to people using the rooms, but not to the animals held within (i.e. they should not be located within the animal pens unless suspended from the ceiling out of the animal's reach).

Guideline 73:

Electrical power outlets for portable equipment are required in most rooms of an animal facility, including animal holding rooms and corridors. These must be safe for both animals and humans, and must be readily accessible without the need for excessive use of extension cords.

Electrical outlets should be strategically located throughout the facility to accommodate most portable electrical equipment without requiring the use of extension cords.

8.2 Equipment

Guideline 74:

The power for specialized equipment (i.e. cage washers, autoclaves, surgical lamps, automated plumbing units, etc.) must be sized and installed according to the recommendations of the manufacturers of the equipment.

8.3 Light fixtures

Guideline 75:

All light fixtures throughout the animal facility should be vapor-proof.

All light fixtures in animal rooms, cagewash area, surgical suite and other areas that may be exposed to water or high humidity must be vapor-proof. It is recommended that all other light fixtures in the facility be vapor-proof as well to facilitate cleaning.

8.4 Monitoring and communication

The electrical and wiring requirements for security monitoring, environmental monitoring and communication must be taken into consideration during the planning phase. These will each be discussed below under their separate headings (see Sections C.9. Environmental Monitoring Systems, and C.10. Security).

8.5 Emergency power

Guideline 76:

An emergency power source must be available for all facilities holding animals for research, teaching and testing purposes.

In order to maintain the health and well-being of animals during power outages, it is essen-

tial that critical functions be supplied with emergency power. A reduction of 50% of the air supply for short periods of time may be acceptable; however, the maintenance of air pressure differentials is essential, especially in containment areas. Sufficient emergency lighting should be available to permit personnel to function safely in the animal facility. The surgical suite should be supplied with sufficient power to allow the completion of surgeries during a power outage. All equipment requiring electricity that could be in use during a surgical procedure must be on the emergency power supply. This includes such items as a portable X-ray unit, as well as the basic equipment, lamps, respirators and electrocauterizers. Emergency power may also be required to maintain the security system.

The most common source of backup power is a diesel-powered electrical generator. The fuel holding tanks should be capable of holding enough fuel to run the generator for a minimum of 24 hours. Generators powered by natural gas are also used, but are dependent on a constant gas supply and are therefore less independent than diesel-powered generators. Propane is a gas alternative that can be stored. Electrical generators are very noisy and require careful positioning with sound and vibration isolation relative to the animal facility.

9. Environmental Monitoring Systems

Guideline 77:

Temperature, relative humidity and differential pressures should be monitored frequently in each and every animal holding room.

The animal environment must be monitored. This can be done with stand-alone devices that record the temperature and humidity; these systems usually require the manual recording of the temperature and humidity on a daily basis. Computer systems have been developed that will monitor more environ-

mental parameters on a more frequent basis and send the information to a central location. For example, temperature, humidity, air exchanges, air pressure and lighting can be recorded for each room in a facility throughout the day. Alarm systems can be built in which will signal if the environment fluctuates outside set parameters. The alarms can also be transmitted by phone lines to remote locations. The environmental monitoring can be tied in with the security system.

Temperature should be monitored and recorded at approximately 90 cm from the floor. Temperature sensors for activation of reheat coils are commonly located in the exhaust duct close to the animal room. This, in effect, reads the sum total of the temperature of the supply air plus heat gain in the room. Humidity can be recorded in the supply air duct.

Permanently fixed air pressure recording devices are becoming more common in animal facilities. Regardless of whether they are built-in recording devices or not, the differential air pressures within the animal facility should be checked on a regular basis to ensure the correct direction of airflow. This is extremely important for barrier units. Differential pressures should be recorded between animal holding rooms and the adjoining rooms or corridor. It may be more practical and effective to measure the actual direction of movement of air between areas than to measure differential pressures.

10. Security

The security system is an essential component of the overall security plan for the laboratory animal facility. There are some very good lock systems on the market that do not allow duplication of keys. Card or proximity badge access systems have the advantage over keys in that they permit the passage of people to be monitored and restrict the times of access. They also have the advantage of being able to quickly delete lost or stolen cards or badges from the system. A card or proximity badge

access system usually works well at the major entry points to a facility and in highly restricted areas. The advantage of proximity badge readers is that they can remain under a protective garment and continue to function. They can also eliminate hand use and are therefore of less concern as fomites. More sophisticated systems, based on the unique anatomical characteristics of individuals (e.g., thumbprints and retinal conformation), are on the market but are very costly. Number keypads may also be useful in less secure areas such as animal rooms. A combination of number keypad and card access can be used to increase security, especially against lost cards.

11. Safety Equipment

Guideline 78:

All required safety equipment must be installed so that it meets safety regulations but does not compromise the functionality of the laboratory animal facility.

Equipment such as fire extinguishers and fire hoses should be strategically located so that they are not bumped by equipment being moved through the facility. Hoses may be mounted in wall recesses. Fire alarms should be mounted so they will not be set off accidentally. Light alarms may be acceptable in some locations (see Section 12.1 Sound). Emergency showers and eyewash stations should be strategically located, but positioned such that they do not impede normal traffic flows. Units are available that fold up or fit into wall recesses.

Sprinkler systems must be installed in animal facilities. The sprinkler systems should be designed so that they are easy to sanitize and do not harbor vermin.

12. Environment

The ability to control the environment within an animal facility is critical to the well-being of the animals held within, the comfort of the users and the validity of the research.

There are many physical, chemical and biological factors which may influence experimental animals and thus modify the results of investigators... The experimental results obtained are, in principle, only valid for the conditions under which they were obtained and only useful for comparison if all the relevant information concerning experimental conditions is made available. (CCAC *Guide to the Care and Use of Experimental Animals*, 2nd ed., 1993, p. 21).

The unequivocal imperative for valid, repeatable research and testing using laboratory animals sets significant demands on the architecture and mechanical engineering required to create an acceptable animal research environment. The environmental factors comprising the challenges to the architecture-engineering team are reviewed below.

12.1 Sound

Guideline 79:

Equipment and activities that generate large amounts of noise should be sound isolated from the rest of the animal facility.

Guideline 80:

Animals that are very sensitive to noise, such as rodent breeding colonies, should be located as far away as possible from noise-generating equipment or noisy animals.

Excessive or inappropriate noise can be irritating and, in some cases, detrimental to animal and/or human health; therefore, noise must be controlled. The animal facility is full of sounds during the active part of the day superimposed on the continuous baseline noise associated with HVAC systems. Cage washers and sterilizers, hoses, high-pressure sprays, and the movement of equipment and cages all generate noise. Certain animals generate considerable noise in one way or another, with the noisiest being non-human primates (NHPs) and dogs. Humans may add substantially to the noise level.

Humans and rats can tolerate up to 80 dB without harm; however, chinchillas, guinea pigs, monkeys and cats are more sensitive to noise and 60 dB is the maximum intensity tolerable when the overstimulation remains constant (Peterson, 1980). It is also reported that hamsters, guinea pigs and mice go through a phase of cochlear development which makes them very sensitive to acoustic trauma. In the animal facility, some of the larger animals can generate noise which exceeds the safe limits stated above (e.g., swine produce noise in excess of 80 dB and NHPs may create noise in excess of 80 dB by clattering and banging metallic objects). However, although the onset of the noise is very startling, it may not be sustained. Dogs, when barking, may produce background noise from 90 to 110 dB. Even though dogs, NHPs and pigs produce these loud noises, there is good evidence indicating that persistent high noise is not good for their health.

Guideline 81:

Animals that produce large amounts of noise should be sound isolated from the rest of the facility.

Animals that produce loud noise, such as NHPs and dogs, should not be kept in large groups, but rather be compartmentalized into smaller groups to control the sound. However, this will not eliminate the need for protective earmuffs when working with these animals.

Anterooms may also act as sound locks and assist in sound attenuation and isolation. This strategy is extremely valuable when housing predictably noisy species.

Guideline 82:

Whenever possible, the frequency of the sound emitted by alarms and bells used in the animal facility should be selected in a range that does not affect the animals. Visual alarms may be used as an alternative in some cases.

Peterson (1980) states that rats are capable of hearing sounds as high in frequency as 60 to 80 kHz (kilohertz, or cycles per second in thousands), and that ultrasonic vocalization plays an extremely important role in their social, sexual and familial behavior. These higher frequency sounds in the animal facility are not necessarily damaging to the rat's auditory apparatus, but can cause significant neuroendocrinological disturbance and affect research results. For example, wild mice trapped at airports have larger adrenal glands than conspecifics in similar terrain beyond earshot of the aircraft. Rabbits and rats exposed to white noise (60 to 16,000 Hz) at 112 dB daily for 1.5 hours, compared to 60 dB for 1.5 hours, showed increased adrenal weights (Nayfield & Besch, 1981). These examples are indicative of chronic stress conditions mediated via the auditory system.

Audiogenic seizures in mice are characterized by generalized convulsions triggered by exposure to intense auditory stimulation. The mice usually start out by wild running and progressively go into convulsions. Death may result from respiratory paralysis. The intensity and frequency of the sound contribute to these audiogenic effects. The optimum condition for audiogenic seizure production is 90 to 120 dB (loud) at 10 to 20 kHz (Seyfried, 1979). Emitters of sounds in this frequency range in the animal facility may be doorbells, alarm bells (fire), jangling keys and banging metallic objects (containers).

Equipment that produces noise at harmful levels should not be incorporated into animal facilities. Low frequency fire alarms are available and very effective (Clough & Fasham, 1975). For example, during a round-the-clock rat behavioral experiment involving constant video-recorded observation, an unannounced fire drill occurred. The audible low frequency alarm emitted an urgent sound (offensive to the human ear) which was very effective. The rats, under close observation at the time, remained unperturbed (Neil, pers. comm., July 1998).

Intercom systems within animal rooms can also be very disturbing to the animals. These should either be eliminated from the animal rooms or muted if deemed necessary (e.g., as an emergency communication device in a higher level biocontainment suite).

Guideline 83:

Sound reducing features should be incorporated into the building structure. As well, sound systems should be used to mask noises generated within the facility.

The fabric of the facility can help to attenuate sound. Mass in the structure is important: the more massive, the greater the ability to absorb sound. Such strategies as filling concrete masonry unit (concrete block) walls with sand or grout are therefore used. Hanging heavy plastic sound baffles may also help in open spaces. Composite sound absorbent panels are now commercially available; however, it is important to check the ease with which they can be sanitized. Sound attenuation and sanitation requirements may conflict, and hence, it may be necessary to reach a workable compromise.

Masking entails the use of sound such as that from a radio or CD system to mask irritating background noises or intermittent bursts of noise which might startle the animals. It is very useful to have an automatic sound system incorporated into the animal facility; not only will it mask background noise, but it will also give some consistency in noise between weekdays and weekends. In addition, it can contribute environmental enrichment for both the animals and the staff.

12.2 Light

Three aspects of light in animal facilities need to be considered: photo-intensity, photoperiod, and quality or spectral composition. These should be considered from the perspectives of both the well-being of the animals and personnel.

12.2.1 Photo-intensity

Guideline 84:

In most animal rooms, and especially in rodent rooms, lighting should be designed to provide at least two levels of intensity during the light cycle.

For most animals, with the notable exceptions of diurnal sight-oriented mammals (e.g., greyhounds), low light levels do not present a problem. Bright light, however, should be avoided. Animals with non-pigmented irises, such as albino rats and mice and white pink-eyed rabbits, are not able to accommodate to more intense light levels. It has been demonstrated that light levels above 325 lux (30 foot candles) for prolonged periods will induce irreversible and progressive phototoxic retinopathy in albino rats. Ophthalmological and histopathological changes observed in the retina that are phototoxically induced are indistinguishable from degenerative changes induced by chemical toxicity or hereditary anomalies (Bellhorn, 1980).

For animal rooms that are to house common species of laboratory animals, the normal light intensity should be approximately 325 lux at one metre above floor level (Bellhorn, 1980). Where task lighting for people is needed in the animal room, it should be restricted in its dispersion throughout the room, if possible. Furthermore, the period of substantially-increased light levels should be minimized. Levels of around 1000 lux (90 foot candles) provide adequate task lighting if used judiciously. An override control will permit increasing the intensity up to a maximum of 1000 lux for limited periods of time. The intensity should automatically go back to the lower level after a set period of time (commonly 20 minutes).

Measuring photo-intensity in the centre of an animal room is fraught with problems because it does not take into account the overall light distribution throughout the room, nor does it address the position and distribution of the cages relative to the light source. The

latter should be considered in planning the positioning of light fixtures if rack and cage deployment is at all predictable. The light intensity on the top shelf of a rack may be considerably higher than that within shelves of the rack, and hence one should avoid placing cages on the top shelf.

12.2.2 Photoperiod

Guideline 85:

Diurnal light cycles in animal holding rooms should be controlled and monitored centrally.

The intensity of light required for humans to carry out their daily activities in an animal room is often too bright for the animals held within and may cause retinal damage. Therefore, it is recommended that the lights be designed so they can be set at different intensities, especially in rodent rooms and for some avian species (see Section C.12.2.3 Spectral quality, for more information on light sources). These lights should be on automatic controls that revert the lights back to the preferred intensity for the animal occupants after a specified time lapse (e.g., 20 minutes).

Where the mechanical services are located in the interstitial space, it is often possible to have external access to the light fixtures. Diagram 24 illustrates the mounting of a light fixture for external access.

Rats and mice are reported to reproduce optimally and show no behavior problems using a diurnal cycle of 14 hours light and 10 hours dark. Most species held for maintenance do well on a 12:12 light cycle. Animals' endogenous rhythms can be significantly skewed if the dark phase of the cycle is interrupted. Therefore, it is recommended that windows to animal holding rooms be occludable. Window closures can be built into the door or opaque magnetic covers can be used.

Nocturnal animals are more active during the dark hours and may not respond well to handling during daylight hours when they are

resting. Reversed light cycles are useful when working with hamsters, marmosets, etc., and in some cases with mice and rats. It has been shown that the length of 'day' (light) and 'night' (dark) in rodents influences: a) hepatic metabolism of drugs; b) pentobarbital sleep time; c) DNA synthesis and mitoses; d) serum cortisone levels; e) serum lipids; and f) body temperature. Therefore, consistency in the diurnal cycle is often critical to reliable research results. In certain circumstances, an abrupt change between light and darkness is not acceptable, and the crepuscular periods of dawn and dusk must be simulated.

12.2.3 Spectral quality

Guideline 86:

The wavelength of light should simulate the natural wavelengths of sunlight as closely as possible.

Most animals do best at light wavelengths similar to that of natural sunlight, ranging from 300 nm to 2000 nm with the majority clustered between 450 nm and 700 nm. The human visible spectrum is between 390 nm and 750 nm. Lighting, and particularly its spectral quality, plays a profound role in the demeanor and work performance of users.

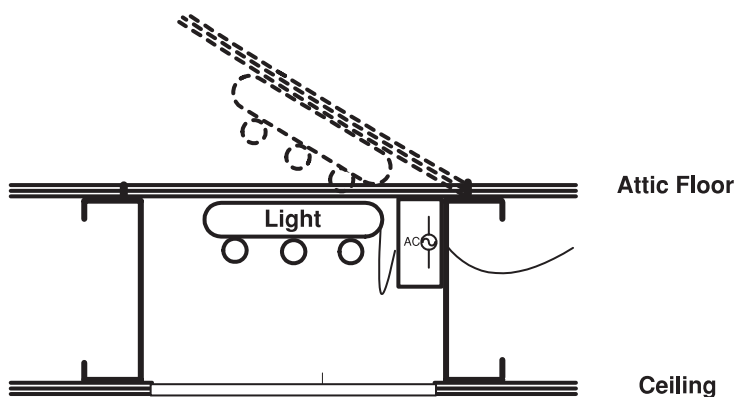

Diagram 24: Light mounting for interstitial space servicing

Plastic cages used to house most rodents may actually alter the wavelength and intensity of light the animals receive, especially if the cages are equipped with filter caps.

12.2.3.1 Incandescent light source

Incandescent light emitted from a standard light bulb with a glowing filament has an emphasis on red or longer wavelengths of the visible spectrum. Although not ideal, this will provide adequate illumination.

12.2.3.2 Fluorescent light source

Fluorescent light, emitted by electrically-charged ionized vapor, approaches sunlight more closely than incandescent light with increased emphasis on the violet or shorter wavelengths of the visible spectrum.

Biologically-balanced fluorescent lighting is now available that contains wavelengths in the ultraviolet range. Both rats and hamsters have been shown to do better under these wide spectrum lights, and therefore, biologically-balanced lights are recommended when using fluorescent fixtures.

The level of illumination in fluorescent lights deteriorates with the life of the tubes. It may therefore be necessary to install lighting at the higher end of the threshold and allow it to deteriorate to the lower range. However, the appropriateness of this approach will depend upon the type of investigation taking place. For example, where 325 lux is required at one metre high at room centre, initial levels at installation may have to be closer to 400 lux, which is unacceptable, particularly for albino rats. A possible solution is a more frequent change of lower intensity tubes or the use of a diffuser.

12.2.3.3 Quartz halogen light source

Quartz halogen light sources provide good illumination; however, they produce a significant load on the heat gain in the room which needs to be effectively dissipated. They can be useful in simulating the crepuscular periods because of their sensitivity to rheostat control.

12.2.3.4 Light emitting diodes

Recent work has demonstrated that light emitting diode (LED) illumination compares favorably in its biological effects with the more common sources of lighting previously mentioned. It has been deemed safe for use with laboratory rats (Heeke *et al.*, 1999). Since the rat has been regarded as the most susceptible laboratory animal to phototoxic retinopathy, this provides a good indication of the element of safety at levels of illumination equivalent to other sources (Heeke *et al.*, 1999).

The advantages of light emitting diodes are that they: are inexpensive to install and maintain (energy efficient); are solid state; have a long life; have a wide range of spectral control; produce low heat; and have a mechanical size advantage.

12.2.3.5 Light tubes

In order to achieve an even distribution of light in animal rooms, the location and spacing of the light fixtures is a critical component of planning and design. More precisely, the points of origin of the light need to be spatially arranged and laid out in the 'reflected ceiling plan'. In many cases, this requires access into the animal room to change tubes or bulbs in the fixtures. It is possible to avoid this where interstitial space exists, so that the actual light source can be positioned above an integral transparent panel in the ceiling and be accessible from above.

Light tubes are a new alternative to provide even light distribution in spaces such as animal rooms, where the actual source of light can be positioned outside the space, facilitating servicing by plant maintenance staff. The

source is at one end of a tube that is designed to distribute even illumination along its length. The technology permits high inaccessible spaces (e.g., large atria) to be evenly illuminated from easily accessed light emitting sources. The units can be used horizontally or vertically.

Currently, the lamps used are metal halide, and these generate significant levels of heat as well as light. However, LED sources may be integrated in the future, which will render the system very adaptable and economical to operate.

The technology offers significant advantages in illuminating restricted access areas, such as biocontainment suites, and also in renovating areas with very limited floor-to-floor distances.

12.3 Heating, ventilation and air conditioning (HVAC)

Cage-top filters were introduced into static isolator systems in the 1980s, enabling better control of cage-to-cage disease transmission. Unfortunately, this type of system creates an equally effective barrier between the cage microenvironment and the macroenvironment of the animal room. For example, the relative humidity (RH) may be increased in the static isolator system by as much as 38% over the room RH; ammonia levels may reach 350 ppm in 7 days (depending on factors such as type of bedding and cage stocking density); and microenvironmental carbon dioxide levels can reach 4000 ppm higher than the macroenvironment of the room.

The problems posed by the static isolator systems are now being addressed by steady replacement with isolator systems in which each cage is individually ventilated. Therefore, it is no longer useful to specify environmental parameters, frequency of air changes, etc., without specifying the type of equipment to be used for primary containment. This may vary considerably between and among species. The impact of the overall HVAC system must be evaluated at the cage level.

Guideline 87:

The heating, ventilation and air conditioning (HVAC) system(s) should provide a healthy and comfortable environment for the animals and for personnel working in the facility. The system(s) should also be capable of regulating the environment within minimally variable set limits in order to supply a consistently stable environment that will not contribute significantly to experimental variability. This includes the uniformly consistent supply of quality air to all microenvironmental units within a room.

The HVAC system should supply clean air at specific temperatures and humidity to the animals housed within a room and exhaust all contaminated air. It is common to try to control environmental parameters at the room level (macroenvironment); however, the real concern should be at the cage level (microenvironment) where the animal is housed. The movement, and hence quality, of air in the microenvironment will be affected by such things as distribution of air in the room, location of the cage within the room, cage design, rack or shelf conformation, species held, bedding type, use of biosafety cabinets, equipment, motors, etc.

Guideline 88:

HVAC systems in laboratory animal facilities must operate continuously 24 hours per day, year round.

Because so much in the animal facility depends upon the continuous operation of the HVAC system, adequate redundancy is critical (see Section 13. Redundancy). Adequate redundancy may vary considerably depending on the requirements of specific zones within the animal facility. Generally, all conventional animal holding space should be supplied with at least 50% of its normal air turnover during short cutback periods of less than 12 hours. It is critical that differential pressures be maintained for inclusion and

exclusion zones. Duplication of fans and an alternative electrical power source to maintain operation of the balanced system to an appropriate level is mandatory. Containment facilities will require exhaust fan redundancy (see AAFC, *Containment Standards for Veterinary Facilities*, <http://www.inspection.gc.ca/english/sci/lab/convet/convete.shtml>). The HVAC systems for animal research facilities are therefore very expensive and may comprise 40% or more of the total construction costs.

12.3.1 Temperature**Guideline 89:**

The temperature of each animal room should be controllable within $\pm 1^{\circ}\text{C}$.

The most common method of controlling temperature is by bringing cooler air to the room level (i.e. 12 to 14°C). The air for each individual room is brought to the preselected temperature by means of a reheat coil immediately before it is distributed to the room. The reheat system is controlled by monitoring the temperature of the air as it leaves the room, which constitutes the sum total of the heat of the air supplied plus heat gain in the room from animals and equipment motors (e.g., fan motors on ventilated racks and in biosafety cabinets). It is important to note that reheat coils supplied from manufacturers are set to fail 'on'; however, in animal facilities they must be set to fail in the 'off' position.

Windows to the exterior make temperature control difficult. Severe cold exterior temperatures in winter and warm summer weather create temperature gradients within spaces due to conduction and convection that are difficult, if not impossible, to deal with evenly throughout the room. In addition, animals in the room may absorb or lose considerable amounts of heat by radiation, depending on their location relative to the window. Therefore, windows are generally not incorporated into animal holding rooms.

The type of caging and bedding will also affect the animal's ability to influence its own environment. For example, animals in stain-

less steel cages with non-contact bedding will usually require room temperatures several degrees higher than those in plastic cages with contact bedding, due to differences in insulation and air movement within the cage.

Guideline 90:

The temperature of each room should be controlled separately.

The approximate heat production of various species is given in Appendix E. The variation in heat production by different species and numbers of animals emphasizes the need for individual animal room temperature control wherever possible.

12.3.2 Relative humidity

Guideline 91:

Relative humidity should be maintained between 40% and 60%, depending on the species, and controlled to $\pm 5\%$.

The relative humidity may be controlled at the suite level, rather than on a room-to-room basis. Most animals do well at 40 to 60% relative humidity, but not less than 35% or greater than 70%. The relative humidity should be kept consistent ($\pm 5\%$). In Canada, building humidity may cause moisture problems and damage to the building structure due to condensation on colder external walls in the winter months. Therefore, animal housing facilities must be extremely well insulated and/or all animal holding rooms may be located in the core of the facility, surrounded by a corridor or service areas with one outside wall and lower humidity levels.

12.3.3 Fresh air

Guideline 92:

Animal facilities should be supplied with 100% fresh air. Air should not be recirculated within the facility.

Good quality air should be available to all animals at all times. The facility fresh air intake

should be located to ensure that exhaust air from the facility or from adjacent buildings is not drawn back into the facility. It is strongly recommended that the positioning of the fresh air intake and its relative position to the facility exhaust and surrounding structures be subjected to fluid dynamic studies. In some cases, sufficient information may be obtained from computational fluid dynamics. However, in other projects it may be necessary to have wind tunnel tests performed on topographical scale models of the site with the facility proposed air intakes and exhausts in different locations and the surrounding buildings located accordingly. The costs of these studies relative to the overall design and construction costs is small, and their contribution to effective and safe function in all meteorological conditions far outweighs the expense.

Each building has a cloak of air, known as the building envelope, that interfaces physically with the structure to the extent that it does not follow the movement patterns of air further away from the building. Contaminants released into this building envelope may migrate to other points on the surface of the building, for example, an office window, a door, or the air intake for the animal facility. Fluid dynamic studies will guide good design features to minimize contaminant intake.

All fresh air is filtered into the facility to remove larger particulates. Where the quality of the air is as 'fresh' as is available but not consistently clean enough due to pollutants, it may be necessary to use more sophisticated filters such as charcoal and HEPA filters. The quality of air in high-density urban areas should be evaluated and appropriate systems should be incorporated.

For economical and environmental reasons, it is best to reclaim as much energy as possible from the relatively large volumes of exhaust air vented from the facility. A system of heat reclamation compatible with the overall design of the HVAC system is recommended.

Guideline 93:

There should be no possibility within the system for cross-contamination of fresh air with exhaust air.

12.3.4 Air exhaust**Guideline 94:**

Air must be exhausted efficiently so that the contaminants in the facility environment do not accumulate beyond acceptable levels.

Guideline 95:

Exhaust ducts should be fitted with filters at the room level to reduce the accumulation of particulate matter in the duct. All exhaust ducts should be tightly sealed.

Animals contribute carbon dioxide, moisture, ammonia (from urea) and allergens to the air. This contaminated air must be efficiently removed from the room so that it does not accumulate in the microenvironment of the animal cage. The air exhaust system should be designed with easily changeable filters (30% pleated) on every exhaust grille within each room to remove all gross particulate matter, such as animal dander, bedding dust, etc. (see Diagram 25). In rooms designed to quarantine animals or contain biohazards, more efficient filters should be used, such as HEPA filters. The exhaust system should be tightly sealed to eliminate the potential for contaminating other areas. The external building exhausts should be located so that air exhausted will not enter other intakes. A local air distribution study at the building site is recommended.

12.3.5 Air exchange**Guideline 96:**

The rate of air exchange within a room must be such that clean, fresh air is available to all animals and personnel at all times. For conventional animal holding rooms, the HVAC system should be capable of supplying and exhausting 15 to 20 air exchanges per hour.

In order to maintain potential air contaminants below acceptable levels, it is recommended that there be 15 to 20 air exchanges per hour in a room. This recommendation, however, does not take into consideration the efficiency of air distribution, the number of animals held or how they are being held. While this recommendation may be effective for large numbers of animals housed in conventional caging with less than ideal air distribution (most systems), the requirement may be considerably higher for animals housed in static filter top cage units or less in rooms where animals are housed in ventilated cage units. Ideally, HVAC systems should be designed so that the number of air exchanges

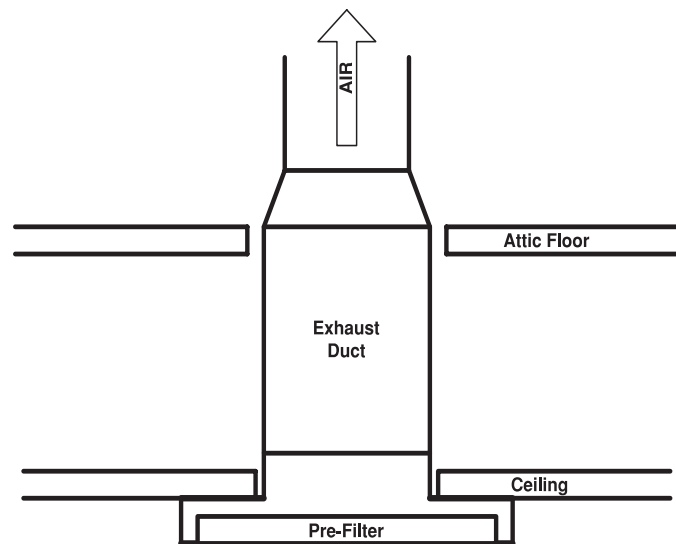

Diagram 25: Exhaust filter detail

can be altered according to how the room is being used; however, increased flexibility must be weighed against the potential for air balancing problems.

12.3.6 Differential pressure

Guideline 97:

Differential pressures can be used to create an air barrier between two areas or zones of a facility. Differential pressures between areas of an animal facility should be set so that air flows from the cleaner areas of the animal facility to the dirtier or potentially contaminated areas.

Differential pressures between rooms and corridors are used to control the movement of air and eliminate a potential source of cross-contamination. Generally, clean areas are kept at a positive pressure relative to dirty areas (i.e. clean animals, clean side of cage washer, food and bedding storage, surgery, etc. should be at a higher relative pressure than dirty animals, quarantine, necropsy, dirty side of cage washer, waste storage, etc.). Those areas needing to be kept clean (exclusion), such as holding rooms for specific pathogen-free (SPF) animals, should be under positive pressure; whereas, those areas where air movement outwards needs to be limited (inclusion), such as biohazard areas, should be negative.

Where greater control of pressure differentials is desirable, anterooms are effective. They create an air barrier between the holding room and the corridor. It is common to set differential pressures in suites for exclusion to have a cascade effect, such that the air pressure decreases as one goes from the holding room to the anteroom, to the corridor, and then to the outside of the suite (see Diagram 26). The reverse cascade effect is often used for inclusion, such that the holding room is the most negative.

The cascade system of differential pressures assumes that specific animals are clean or dirty and will always remain that way. In actual fact, many disease research experi-

ments require the use of clean animals that are intentionally infected with disease organisms, and there is also the possibility of clean animals becoming infected unintentionally. Therefore, in many cases, it is beneficial to consider a system that offers both inclusion and exclusion at the same time. Such a system may be established by supplying clean air to an anteroom at a pressure greater than that of both the holding room and the corridor (see Diagram 27). With proper management, the positive pressure anteroom should provide an effective way of establishing an exclusion barrier, an inclusion barrier and a combined inclusion/exclusion barrier.

In order to maintain differential pressures, doors must be closed and the time that the doors remain open should be minimized. In order for anterooms to be effective barriers, only one door of an anteroom should be opened at a time; otherwise both differential pressures are eliminated, thus destroying a major function of the anteroom. It is essential

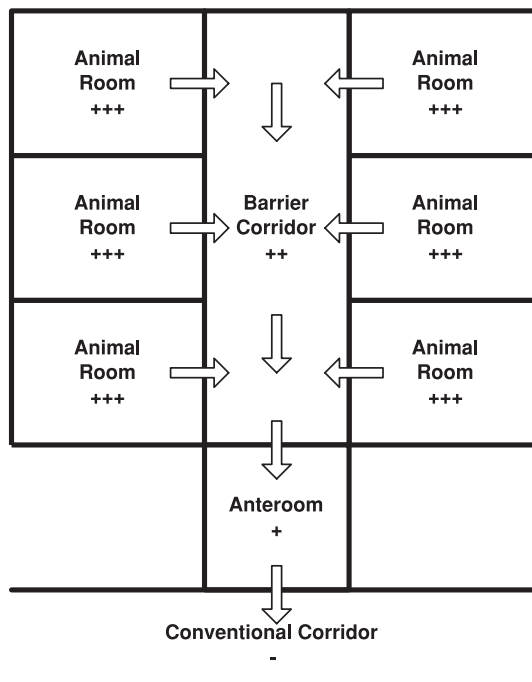

Diagram 26: Differential pressure — cascade effect

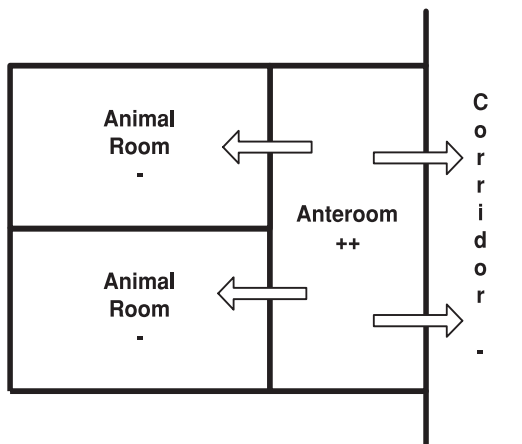

Diagram 27: Differential pressure — air barrier effect

to have well-sealed rooms in order for differential pressurization to work.

Differential pressurization is very difficult to control directly and it is recommended that pressures be controlled by volumetric offset (recommended by the American National Standards Institute). This implies that room pressures are set through controlling the volume of air taken in versus the volume exhausted. For example, to achieve a positive pressure in a room relative to a corridor, air could be blown into the room at 500 cubic feet per minute (CFM) and exhausted at 400 CFM. Assuming the room is well sealed, the excess 100 CFM would be forced out into the corridor through small cracks around the perimeter of the door.

12.3.7 Air distribution

Guideline 98:

Air distribution within a room must be such that clean, fresh air is available to all animals and personnel at all times.

Provision of good quality air requires well-distributed movement of air within the room without causing drafts on the animals that

may affect their ability to maintain body temperature. Diagrams 28a) and 28b) show two possible set-ups of room air intake and exhaust that have worked well in past applications. The air capture and containment system (see Diagram 28b) is reported to be the most versatile method of air supply and exhaust. The airflows 'wash' the air out of the room thoroughly and exhaust it in what appears to be virtually a one-pass system. The system uses four-way air diffusers on the underside of a central longitudinal ceiling soffit. This creates a capture hood effect on either side of the soffit. The exhaust registers are located on each side of the soffit. Limited practical experience to date has indicated that the air capture and containment system is both effective and versatile. It is also cost-effective to install.

Conventional wisdom for many years recommended high-level (ceiling) supply of fresh air and low level returns placed in the corners of the room (see Diagram 28c). Recent studies at the US National Institutes of Health have indicated that this configuration works well in rooms using static microisolator cages.

A goal of the ventilation system should be to minimize the concentration of allergens in the environment. Laboratory animal allergens are not readily removed with traditional animal room ventilation. The standard 15 to 20 air changes per hour delivered and removed by conventional methods (not laminar flow or mass air displacement systems) serve to keep the most hazardous allergen-bearing particles between 5 to 10 nm evenly suspended and distributed. Swanson *et al.* (1990) demonstrated that rats produce allergens at a high rate, and it was estimated that 125 air changes per hour would be required to effectively control airborne rat allergens, which is beyond the capability of conventional ventilation systems. In order to effectively control allergens, a system of mass air displacement or negatively-ventilated cages should be used.

Mass air displacement systems are effective in reducing airborne allergens (see Diagram 28d) and can provide 100 to 150 air changes per hour draft-free. In this system, 90% of the

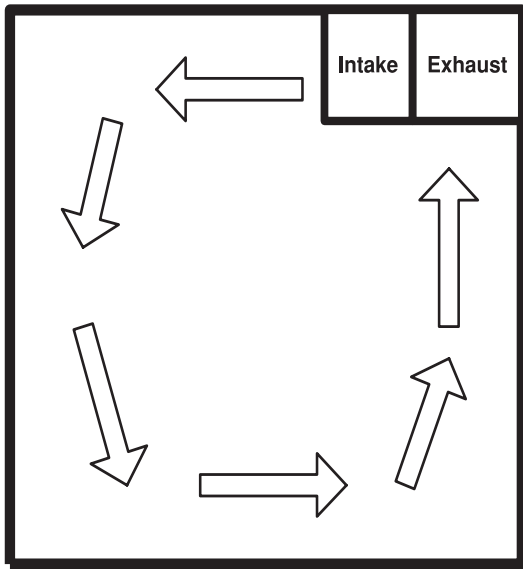

Diagram 28a): One-sided intake and exhaust

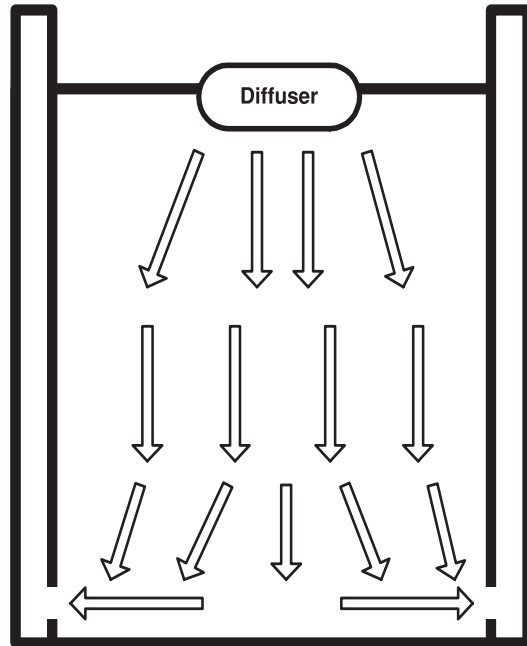

Diagram 28c): High intake/low exhaust

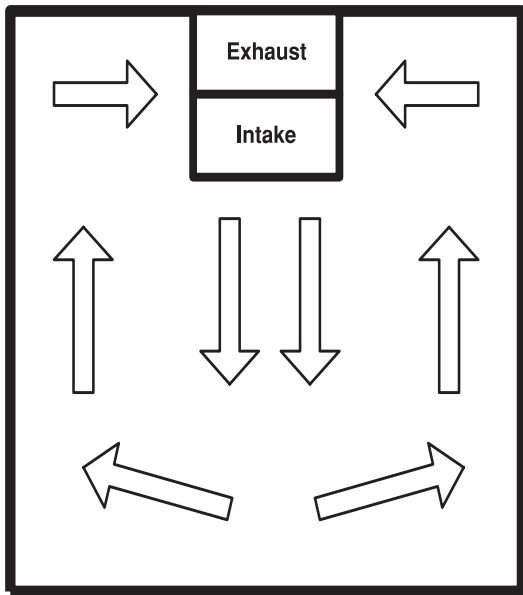

Diagram 28b): Central intake and exhaust

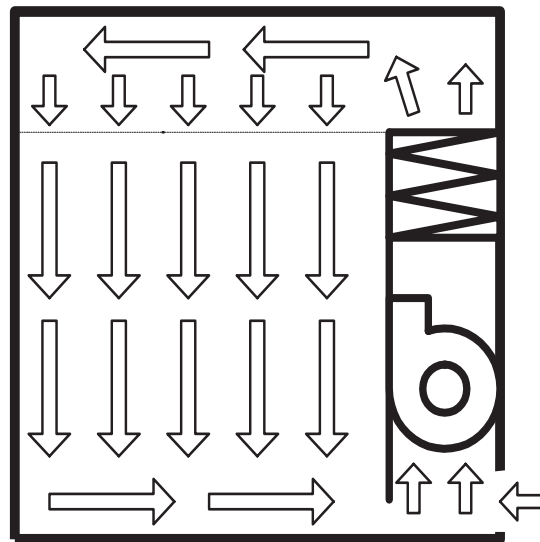

Diagram 28d): Mass air displacement

exhaust air from the room is mixed with 10% fresh air and then passed through activated carbon and HEPA filters (99.97% efficient for particles of 0.3 μm or less) before being re-delivered to the same room. The air is delivered through small apertures over the entire surface of the ceiling so that the overall room air movement is not noticeable and is laminar in its distribution (see Diagram 28d). These systems are costly and their use in animal facilities is usually limited to portable units used to establish small confined clean environments for small numbers of animals, or to establish a sterile surgery station in an otherwise dirty environment, such as a research laboratory.

Free-standing recirculating HEPA filter units have a high air turnover rate. They act rapidly and can be used effectively to reduce airborne particle burdens, including allergenic contaminants. Portable units are very useful in areas such as surgical suites or for establishing cleaner environments in otherwise dirty areas, such as conventional animal units or research laboratories.

When designing new air distribution systems and/or new room configurations, it is recommended that the air distribution within the room be tested using room mock-ups with equipment in place prior to construction. Computational fluid dynamics has now developed to a point where air movement within the animal room and thermal dynamics can be predicted and visualized. The programs facilitate the study of different cage rack or pen configurations.

12.3.8 Ventilated cage racks

Ventilated cage racks are being used more often in animal facilities to protect the animals from disease, supply better quality air, improve the animal environment and reduce human exposure to allergens. Ventilated racks may have a significant impact on the design and use of the HVAC system. There are several ways that ventilated racks can be incorporated into a facility and each has different implications on design of the HVAC system.

A positive pressure ventilated rack (see Diagram 29) is used to protect the animals within (i.e. exclusion). Room air is drawn through a HEPA filter and then blown through plenums into filter top cages (see Diagram 30). Exhaust from the cage escapes through the filter top and around the edges of the cage-top interface. The motor on each rack, as well as the animals, will contribute heat to the room. Exhaust air should be free of most particulate matter, but will usually have considerable odor and other contaminants; hence frequent room air exchanges remain critical.

A negative pressure rack (see Diagram 31) is used to protect the environment outside the cage from contaminants and potential allergens (i.e. inclusion). Negative pressure is created by forcibly exhausting the air, either by a portable exhaust motor with HEPA filter and/or by connection to the room exhaust. The movement of air at the cage level is illustrated in Diagram 32. The portable motor should give good control over the rate of exhaust and the HEPA filter should remove particulate matter, including allergens. Un-

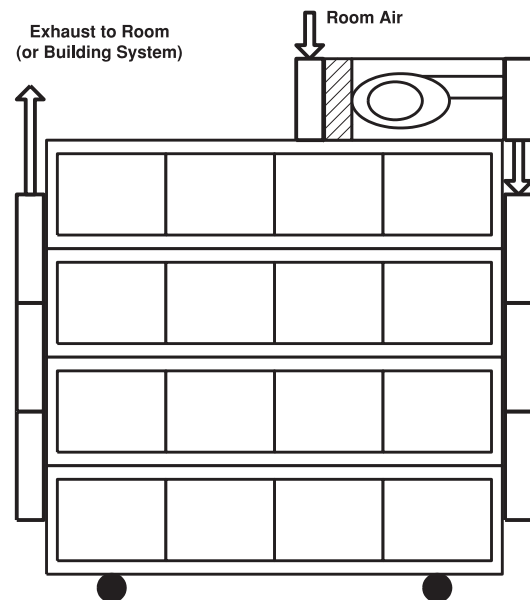

Diagram 29: Ventilated rack — positive pressure

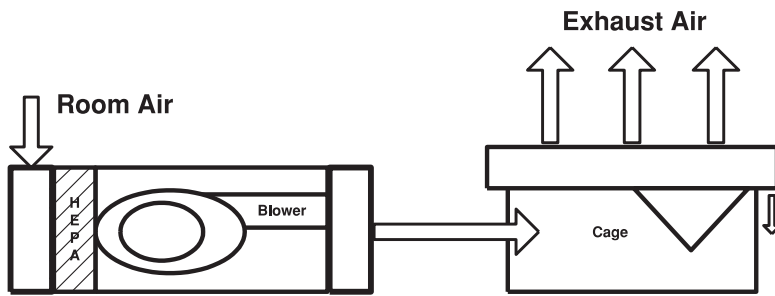

Diagram 30: Ventilated cage — positive pressure

less it is connected to the room exhaust air duct, however, the system will contribute odors, animal heat and motor heat to the room, necessitating frequent air exchanges.

The use of two independent motors for supply and exhaust on ventilated racks (see Diagram 33) will allow the cages to be maintained at negative or positive pressure, provided the supply and exhaust is directly connected to each cage. Another variation of this system involves the scavenging of exhaust air from around the cage rather than from directly within (see Diagram 34). In this type of unit, the cage is kept at a positive pressure while the area surrounding the cage is kept strongly negative, thus giving both an inclusion and exclusion system if designed efficiently. Both the intake and exhaust air of these units are HEPA filtered. The heat generated by two motors per rack, as well as animal heat and some animal odors, is released into the room, thus increasing the room ventilation requirements. The room ventilation requirements can be reduced significantly by attaching the rack exhaust to the room exhaust, or better still, to a dedicated exhaust.

Another type of ventilated rack is a negative pressure rack for both inclusion and exclusion that is solely dependent on the building exhaust for removing air. The air is filtered into tightly-sealed cages via polyester filters and exhausted by connecting the rack directly to the room exhaust. The lack of motors in these units means quieter running systems without the additional motor heat. The fact

that they are directly connected to the exhaust system means that heat and pollutants generated by the animals are exhausted outside the room. This should reduce the need for high room air exchanges.

If a room is supplied with HEPA filtered air at positive pressure to the cages, a negative pressure rack will function effectively as both an inclusion and

exclusion barrier. This is the recommended set-up to provide maximum flexibility and safety for both the animals and the users. This relies on the assumption that effective biosecure room entry and exit SOPs are in place and that a biosafety cabinet will be used for all animal manipulations.

The fan motors operating the supply and HEPA filtered exhaust systems on ventilated racks may create noise and vibration that seri-

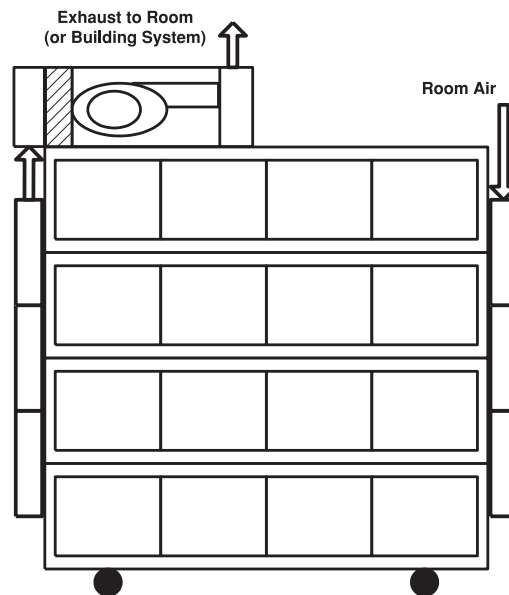

Diagram 31: Ventilated rack — negative pressure

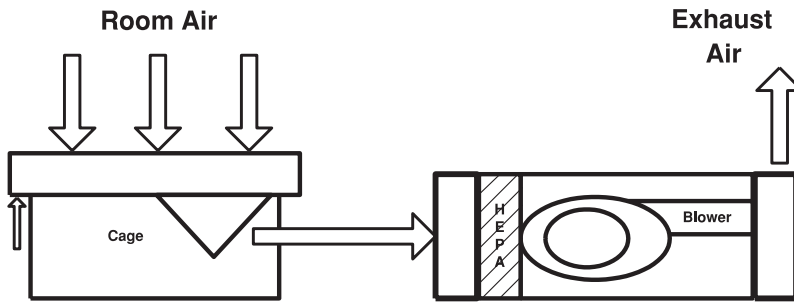

Diagram 32: Ventilated cage — negative pressure

ously disturb the animals. Some manufacturers have these units wall-mounted and set underneath or beside the rack to attenuate both noise and vibration.

Ventilated cage racks have been useful when retrofitting older facilities. They increase the animal holding capacity per room and can reduce the frequency of cage changes. Negative pressure ventilated racks are becoming more important for the effective management of laboratory animal allergens (see Section 12.3.7 Air distribution). For this reason alone, all new facilities involved in the care and use of small rodents, particularly in large numbers, should seriously consider the incorporation of ventilated cage racks in their design process.

13. Redundancy

Guideline 99:

HVAC systems should be designed to provide adequate air exchange and maintain critical air differential pressures during mechanical breakdowns and power outages.

Guideline 100:

All animal facilities must have an emergency electrical supply capable of maintaining at least some of the functions of the HVAC system and essential services.

The maintenance of air pressure differentials is essential, especially in inclusion or exclusion situations, in order to contain a biohazardous risk and protect extremely valuable animal research stock from contamination. Critical areas should be identified and HVAC systems built accordingly, with

appropriate controls and monitoring systems.

Fresh air at the appropriate temperature must be available 24 hours per day, year round. The animal facility should be divided-up into various functional areas and separate HVAC systems designed for each. For example, separate HVAC systems could supply the animal rooms, the surgical suite, personnel areas and each biocontainment area.

There should be more than one supply and exhaust fan to all of the above areas, with the

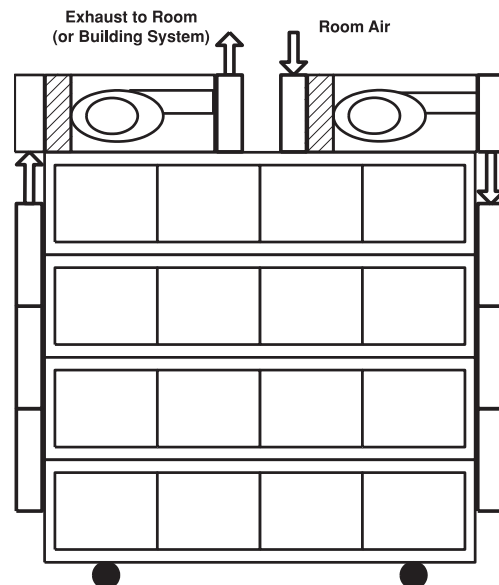

Diagram 33: Ventilated rack — positive/negative pressure

possible exception of areas for human occupancy. The total maximum capacity required for each area may be divided by the number of supply and exhaust fans to be installed. Ideally, if two complementary fans are to be installed, each should be capable of supplying 100% of the total required capacity during an outage of the other fan. Normally, the fans should be used at 50% of their total capacity, with the anticipation that outage times will be less than 12 hours. The supply and exhaust fans should also be sized and controlled so that differential pressures between critical areas are maintained during the failure of a fan. In containment facilities, an exhaust fan must be functional and capable of maintaining the containment facility at a negative differential pressure at all times (AAFC, *Containment Standards for Veterinary Facilities*, <http://www.inspection.gc.ca/english/sci/lab/convet/convete.shtml>).

Backup chillers and heat exchangers should also be installed. It is recommended that they be individually sized to meet maximum requirements independently, and then that they each be run at 50% capacity. This will allow one unit to meet all requirements while the other is being repaired or maintained. An example of a dual parallel HVAC system is given in Diagram 35.

Generator capacity to operate the animal facility at normal levels during grid failures is recommended. If this is not possible, then power must be available to maintain the HVAC system, emergency lighting and other critical equipment, such as surgical lights and life monitors. Continuous operation without compromising the health and welfare of the animals is fundamental to the commitment to the best principles of animal care and the protection of the research programs.

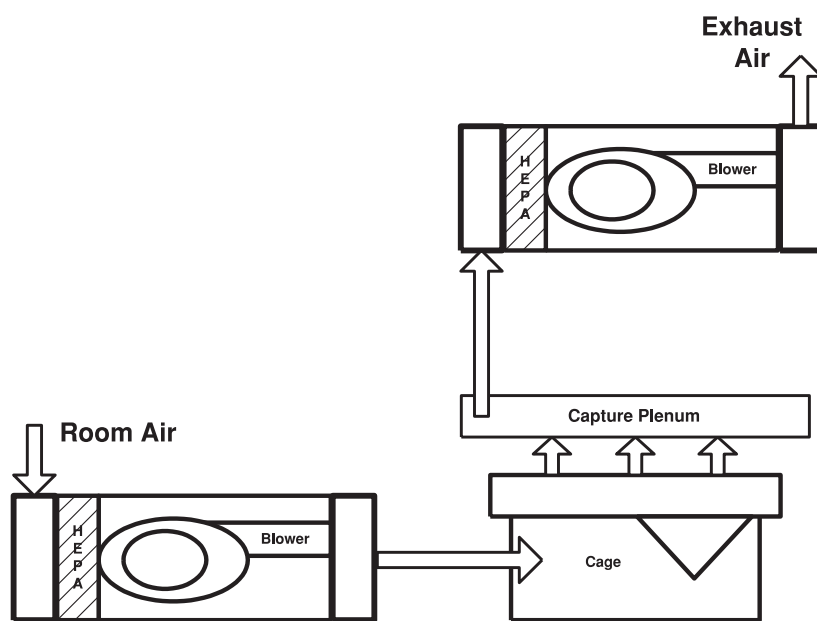

Diagram 34: Ventilated cage with scavenging system

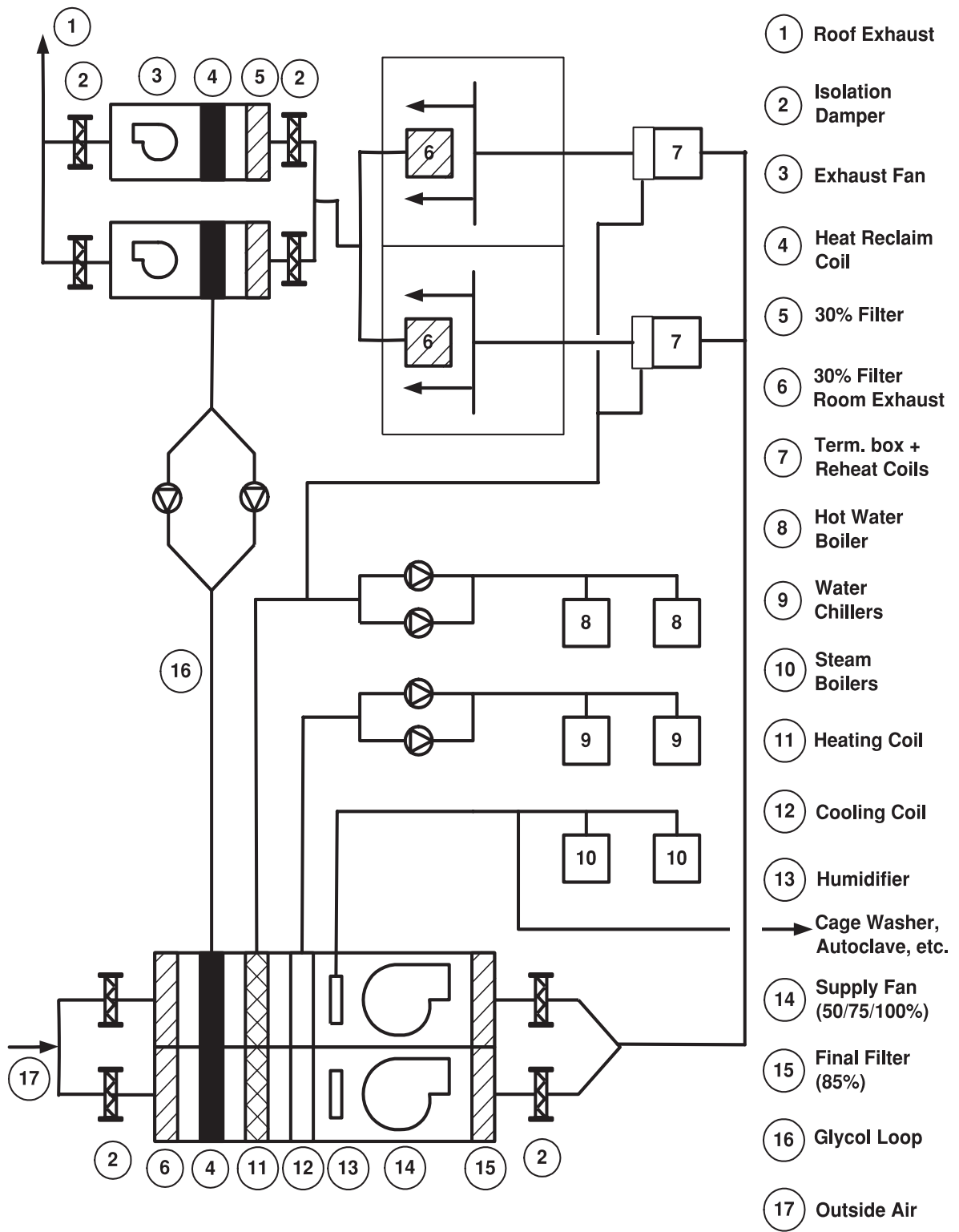

Diagram 35: Dual HVAC system

D. THE PROCESS FOR THE PLANNING, DESIGN AND DEVELOPMENT OF A LABORATORY ANIMAL FACILITY

Animal facilities built to appropriate architectural and engineering standards are expensive to build. The finished structure should reflect both the present and, as far as possible, the future needs of the research community. In addition, the structure should be integrated into a cohesive design in which the animal care staff and the physical plant maintenance personnel can each perform optimally. The collective outcome must be an enhanced research environment and the uninterrupted facilitation of excellent animal care practices.

The considerable size of capital investment required is such that every effort must be made to ensure that planning, programming and design are not flawed.

Ensuring a satisfactory result involves the input of many people. It also requires professionally-guided acquisition and integration of the information which will drive the programming, design and ensuing construction to an ultimately successful conclusion.

The process may be broken down into four basic stages:

1. Programming
2. Design
3. Construction and commissioning
4. Occupancy and operation

1. Programming

This is arguably the most important stage in planning an animal facility. A comprehensive program must be developed before an integrated layout of the facility components and fixed equipment can be attempted.

The program will form the basis of instructions and guidelines for the architect and engineer to develop detailed designs. Following the clear identification of need, as out-

lined above, the next step is the preparation of detailed space data sheets combined with space relationship diagrams. This is often referred to as a 'detailed space program'. It should also take into consideration budget constraints.

The programmers have fundamental tasks to complete in order to prepare a detailed space program. These are to:

- a) develop a clear mission statement (purpose) and define the goals and objectives of this project. These goals and objectives must be fully supported (if not defined) by senior administration;
- b) define the functions required to meet these goals and objectives (including the number and type of staff, research animals, and biological, chemical and radioactive agents). The functions must be defined by experienced research and technical staff, under the control of senior management, to avoid the 'excess wish list syndrome'. Future requirements must also be addressed so that the facility offers adequate space for a reasonable number of years. Researchers should be required to prioritize these needs to keep the project cost-effective;
- c) identify all criteria (budget, regulations, guidelines, by-laws, etc.) that may have an impact on the project;
- d) define the space requirements needed to accommodate the present and future functions and occupants (including services and equipment). Space requirements should be defined by experienced planners and should be tested by comparisons to similar existing functional use spaces to ensure adequacy and efficiency. This applies to services and equipment as well;
- e) develop detailed space data sheets that include the design requirements for each identified space. This information includes:

- functional description;
 - dimension requirements;
 - finishes and hardware;
 - furniture and equipment;
 - plumbing, heating, ventilation and air conditioning;
 - lighting, power and communication; and
 - equipment and accessories, etc.;
- f) define required functional adjacencies by graphically linking the various components of the animal facility together;
- g) co-ordinate and document the definitions and information in a report that can be used to develop a preliminary schedule and cost estimate. This is an extremely important document that is often used to sell the project to senior administration or funding agencies; and
- h) develop a budget.

Once these tasks are understood, it is important to make sure that the team members are capable and experienced in these areas. At least one key person from this team (preferably an end user) should continue on as a participant in all the other stages to maintain continuity. The following individuals should be consulted and, in most cases, play an active role in the planning phase:

- a) the senior administrators directly involved with the project. These people control the budget and make all major financial decisions. They are involved in prioritization throughout the institution and know the animal facility's status in this context;
- b) the institutional directors of planning, facilities, etc. They oversee the emerging need for compatibility with institutional policies and objectives as the program develops. They will retain the appropriate architectural and engineering consultants for the project. The planning office will usually convene all the fact-finding activities from the very beginning;
- c) the investigators who are using, or intend to use, animals (their major input will be dealt with in more detail below);
- d) research department heads with an overall view of the direction and emphasis of the research program and of future needs;
- e) the research technicians who will be using animals in the facility;
- f) the facility director as the principal advisor on compliance with animal care, care and use guidelines and regulations, and laboratory animal science issues, and as the principal manager of the facility and the personnel who will operate it;
- g) the laboratory animal veterinarian(s) for application of sound principles of laboratory animal science and medicine;
- h) the laboratory animal technicians who will be responsible for operating the proposed new facility and who will have invaluable input into appropriate ergonomics and equipment utilization;
- i) plant maintenance supervisors who are responsible on-site for keeping the facility fully operational, electrically and mechanically;
- j) occupational health and safety advisors and compliance officers for radiation safety, biosafety, etc. The criteria for safety guidelines must be present from the very beginning; and
- k) a security officer who is familiar with the institutional security requirements and the unique requirements of animal facilities.

Although the tasks involved in a detailed space program appear to be straightforward, it is preferable to engage the services of an experienced programmer (architect or engineer) at this stage, unless the project is relatively simple. Animal care facilities are not common and the regulations and technology are changing rapidly; therefore, it is often difficult to find local consultants who are experienced with current animal care requirements.

If the institution has knowledgeable users who are experienced with the design process, local consultants may be engaged and educated to understand the peculiarities of animal care facilities. Consultants with extensive medical care or research facility experience usually adapt to these peculiarities quickly. If there is no access to in-house experience, it is wise to engage an experienced animal care consultant to prepare the program. The program team should be encouraged to challenge all preconceived notions of the users and examine alternative approaches to providing the most flexible and effective program criteria.

1.1 Information gathering and communication

All relevant information should be collected and matched until the influence of each component of responsibility has been integrated into a statement of specific requirements.

1.1.1 The interview process

What is involved? Institutional representatives such as the director of laboratory animal resources and key managers, together with the director of planning or a designate, should meet with all of the investigators or groups of investigators and determine the future needs. A similar meeting should occur with the compliance and safety officers and physical plant supervisors. The programming consultant(s) should be familiar with the goals of the interviews and should be able to facilitate this stage of the process.

Why are the interviews conducted? The interviews with the principal investigators and their research teams are not only critical for extracting data relevant to project size and scope, but also for determining physical support for optimal performance. The current numbers of animals, rooms, cage types, etc. should be available from current inventory. Future projections can be sought by verbal communication and written forms. However, additional information from the respective individuals and research teams must be sought. During personal interviews, the fol-

lowing questions may assist in eliciting productive discussion:

- What does your research involve?
- Where does animal use fit into the big picture? Will the level of animal use increase or decrease?
- How do you do your animal work? (This relates to the physical activities.) How might your work be better facilitated?
- In which places do you currently perform the work? What is good about and/or what is not good about these areas?
- What movement of personnel and animals is involved?

As the questions are dealt with, discussion should be encouraged on current concerns and problems, and obvious improvements. The discussions should be of a 'brainstorming' format. All information is relevant and must be recorded, even when it does not appear to have any immediate impact. For example, an investigator casually mentioned that some old silos had proven really valuable for the creation of simulated natural environments for certain critical experiments with wildlife. At the time, he was already readjusting his research priorities around a bright new animal facility with standard animal rooms in which he had been told this would no longer be possible. The notes on his comment were the seeds of what subsequently became a few specially-designed and constructed animal rooms of great versatility called the 'simulated natural environment suite'. This unit had all the desirable features of the old silo, but with many essential and desirable features added to meet contemporary standards.

1.1.2 Gathering existing information

In an institution where animal research is ongoing, information should be available to establish the current size and scope of the operation. For example, answers to these questions should be available:

- a) How many mice, rats, rabbits, guinea pigs, etc. are held at one time (maximum)?

- b) How many of each of the above are specific pathogen-free (SPF), viral antibody-free (VAF), conventional, etc.?
- c) How many animals and what type are maintained in Biocontainment Level 3 at one time?
- d) What forms of barriers or sequestration are currently being used?

There is a need to know how the animals in each particular situation are housed (e.g., singly, in pairs, triads, groups of four, etc.) and from this, the numbers of cages, etc. needed can be estimated. It is then possible to compute an estimate of the number and type of cage racks, pens, tanks and runs needed in the different zones of the animal facility, such as biocontainment, disease-free rodent barrier area, SPF beagles, hagfish, frogs, etc.

Decisions related to the degree of separation of groups of animals are among the most difficult. For example, in older facilities, five, six, or more investigators may share a mouse room. How do they really feel about this? How does the laboratory animal veterinarian view this? How do the laboratory animal technicians see this working in relation to their obligations to each investigator? Are lots of small spaces going to be more valuable than fewer larger rooms? Can adequate sequestration be accommodated by the newer individually-ventilated cage systems?

1.1.3 Incorporating new ideas

Planning a new facility presents an opportunity to re-evaluate how each facet of the operation ought to be done in light of current knowledge in epidemiology and disease control, environmental factors, housing methods and environmental enrichment, improved hygiene standards, upgraded radiation safety and biocontainment requirements, more designated procedural areas, etc. Meeting more sophisticated requirements and providing greater versatility is a challenge, but also an opportunity to build a facility that complements the performance of exemplary contemporary practice. Meeting this challenge requires thoroughness in the information gathering process.

1.2 Estimating the size and scope of project

In proposed units where only a few investigators will be involved, each of whom have predictable and fairly constant needs, it is relatively straightforward to determine the type of animal rooms, ancillary spaces and gross area required. As the number of investigators increases, the complexity of programming increases exponentially, and estimating the size and scope of an animal facility solely on the basis of individually-perceived needs can lead to large overestimations, especially if needs fluctuate. However, the growth of the institution and the needs of any researchers who will be recruited in the future also need to be considered. This is where experience with user requirements is extremely important. The 'wish list' must be given a reality check to eliminate those things that are not feasible or may jeopardize the project because of budget. Duplication must be eliminated and some services combined. This is an extremely important but often difficult and tedious task. Appendix C illustrates how the interview data can be used to estimate the size and scope of the project. This information is then incorporated into the plan.

1.2.1 Identify all criteria

All of the guidelines, rules and regulations that may affect the design of the laboratory animal facility must be incorporated into the detailed space program. Therefore, the program team must be familiar with the criteria outlined in these guidelines, as well as local codes and regulations. For example, the required air temperatures, humidity, air exchanges, wall finishes, floors, etc. must be clearly specified for each space.

1.2.2 Ergonomic considerations

A clear understanding of the ergonomics of the general operation and maintenance of the animal facility is essential for effective design.

Many tasks in animal facilities can be physically demanding or expose workers to allergens and create the potential for work-related injury. Common examples of this are:

- lifting and moving cases of water bottles, particularly after they have been filled;
- handling and moving bags of food and bedding;
- handling bags containing soiled bedding;
- distributing clean cage racks and cages in the facility;
- collecting soiled equipment and delivering it to the dirty equipment staging;
- emptying the soiled contents of each cage prior to washing;
- distributing bedding into clean cages, manual or machine assisted; and
- repeated bending or stooping to access cages on the lower shelves of cage racks, and stretching or using step-up devices to access higher shelves on cage racks.

Equipment is readily available commercially to help deal with many of the physical challenges encountered in the animal facility. Examples of this are:

- automatic watering systems which virtually replace the use of water bottles;
- hand-operated, electrically-powered hydraulic dollies for movement of food and bedding bags;
- electrically-powered towing units for rack and cage movement;
- effective vacuum systems for removing soiled bedding from dirty cages (without the need to scrape or bang them) and for the bulk collection of this material in containers for subsequent removal by motor vehicle;
- robotic systems that effectively pick up and knock out soiled bedding from cages prior to loading them on the tunnel washer belt;
- robotic systems integrated with tunnel cage washers that collect and stack clean cages; and
- safe, ergonomically-designed mobile platforms and stools for sitting to facilitate work with higher and lower rodent cages.

1.2.2.1 The animal room layout

The introduction of ventilated isolator cage systems (VCS) units enables larger numbers of rodents (particularly mice) to be housed within an animal room than ever before. To take full advantage of the biosecurity afforded by VCS units, it is necessary to change cages and manipulate animals in biosafety cabinets (BSC) or in mobile cage stations with BSC equivalency that are manufactured specifically for the purpose. Where the number of VCS units and cages in the room is high, the use of the mobile change station is mandatory for efficiency and practicality. Since double-sided BSC units tend to be integral to the effective utilization of space, the circulation patterns of personnel and/or mobile equipment require careful attention.

In larger mouse rooms, great care should be taken to ensure that the servicing of the animal room by animal care staff does not clash with activities of the investigator's team. For example, animal care activities should be facilitated to the extent that they are efficient and not inordinately time consuming. Manipulation space for the investigator's team should be distinct from that of the animal care personnel.

The layout of the animal rooms, particularly where VCS units are involved, is therefore a vital part of the planning and design process in which particular attention is paid to the effective movement of animal care equipment in the room and the various groups working there.

1.2.2.2 Modeling or mock-ups

The use of life-size mock-ups is recommended to examine the ergonomics of the animal facility, particularly the animal rooms. This does not necessarily require the actual apparatus, but the dimensions must be precise to enable personnel to act out the physical aspects of the various tasks within a given space. Personnel location, task interaction and traffic flow can be much better understood and planned for when realistic scenarios are attempted. Staff interaction in this process is essential.

1.2.3 Impact of management decisions

The potential use and management of a facility contribute important criteria that should be considered in the design. Management and design should go hand-in-hand and complement each other. For example, if one assumes that there will be separate personnel working on the clean and dirty side of the cage washer, the area may be designed so it is very cumbersome to pass between the clean and dirty sides. However, if it is known ahead of time that only one person will be hired, then a clothes changing station and possibly a shower can be built between the two areas. Assuming all of the information regarding the potential use of the facility has been collected, it should be possible to make some management decisions that will have a significant impact on the design of the facility. Some examples of management criteria that may influence design are given in Table 1.

1.3 Integrating the program

1.3.1 Detailed space data sheets

The programming team combines the current information with that collected in the interview process to identify the types and sizes of spaces required. This information is com-

bined with the criteria above to develop detailed space data sheets that outline essential requirements for each space (see Appendix B).

1.3.2 Functional relationships

In addition to the detailed space data sheets, the programming committee must identify all required functional relationships and traffic flow patterns between the various spaces (see Section C.4. Functional Adjacencies and Section C.5. Traffic Flow Patterns). For example, the dirty side of a cagewash area should be located such that there is good access to a loading dock for waste disposal. The required functional adjacencies are commonly depicted with the use of bubble diagrams, such as those shown in Diagrams 14 to 19.

1.3.3 Budget

Once the previous stages of the program have been completed, it should be possible to derive a fairly accurate estimate for the cost of construction of the proposed facility. It is at this point that the services of a professional cost consultant (quantity surveyor) are required. The cost of construction of similar facilities may be useful in deriving rough estimates. If the estimate is greater than the amount budgeted for in the planning phase, then it is necessary to review the program in

Table 1: Influence of Management Criteria on Design

Management Criteria	Possible influence on design
Number of users	Security, number of holding rooms
Number of staff	Number and type of barriers between areas
Qualifications of staff	Voluntary versus forced barriers
Services offered	Procedures rooms (e.g., necropsy and surgery)
Quality of animals	Procedures, air pressure control by room or area
Normal working hours	Security systems, lighting
Designated clean and dirty areas	Barriers, number and location of corridors

detail. The scope or size of the program will have to be reduced if additional funds are not forthcoming, or alternatively, the program may be divided into phases if there is a reasonable chance that further funding may be forthcoming in the future. It is irresponsible to proceed to the design stage if the program is not within budget. It should also be remembered that changes are more costly further into the design and/or construction stages. Therefore, it is essential that the program be well prepared to meet the needs as closely as possible within budget constraints.

The funds committed in the planning phase must be divided up into a budget. The line items in a budget are additional criteria that must be incorporated into the program.

The total project costs are the sum of the following items and make up the 'capital funding budget':

- a) **Design fees:** All costs involved in the design process, which include architectural and engineering planning, drawings, etc. This may include the cost of programming if it is under the same consultant. It has become more common, however, to hire one consultant for programming and subsequently a different design consultant. In this case, the programming fee is distinct from the design fee.
- b) **Administration fees:** These are the funds necessary for:
 - project management (from beginning to end); and
 - commissioning of surveys, soil testing, fluid dynamic studies of air movement in building clusters, etc.
- c) **Construction costs:** The major part is the costs to construct the physical structure, including mechanical and electrical systems; however, other construction costs must also be noted.
- d) **Equipment:** This is divided into:
 - **fixed** — whether such things as cage washers and autoclaves, etc. are in-

cluded in the construction costs should be clarified at an early stage;

- **movable** — cage racks, carts, steam cleaners, pens, etc.;
- **furniture** — benches, cupboards, desks, etc.; and
- **miscellaneous** — items not covered in the above three categories (e.g., an electric tractor for pulling flat carts loaded with cages and closed circuit TV for the genetically modified animal suite).

Variability obviously exists from place to place. It is very important to know how each of the above categories is to be funded.

- e) **Commissioning costs:** The funds required by the institution to get the facility up and running, which can be quite demanding with animal facilities.
- f) **Moving and decanting costs:** Moving-in costs occur in all types of projects, but the situation is often complicated because large numbers of animals of varying status may have to be moved. These animals could be particularly vulnerable colonies, such as VAF, inbred, transgenic mice, or SPF beagles in a long-term reproduction study. The movement of these types of animals has to be carried out with extreme care. It is very labor intensive, time consuming and expensive, and may require special equipment. Decanting is the by-product of renovation. In order to renovate, all of the colonies and functions have to be moved elsewhere. When the renovation is complete, everything is moved back again. This may involve moving animals into temporary quarters, such as trailers. It can be very expensive; moving costs are double (there and back again) and some investment in the temporary accommodation may be necessary. When comparing total project costs for renovation versus new construction, decanting costs may well prove the equalizer. In certain circumstances, new construction, although it has had a higher per-square-metre cost

compared to renovation, has proven to be substantially less expensive by the time double decanting and temporary accommodation costs are included in the total budget. New construction also generally provides better space that can be used over a longer period.

g) **Contingencies:**

- estimation contingencies
- construction contingencies

There are inevitably unforeseen elements in both of these. Funds must, therefore, be reserved to deal with these contingencies as they arise so that the project is not compromised as they occur.

h) **Escalation:** Construction costs, like everything else, are subject to inflation. The time lag between the onset of a project and its completion may be several years, depending upon the size and urgency. Thus, the cost estimate for the proposed building is prepared at current prices and an escalator or inflation factor is used to estimate what the proposed costs will be when the competing contractors submit their bids and the price is finally fixed.

i) **Value added taxes:** Such taxes as the Canadian Goods and Service Tax (GST) must be accounted for.

j) **Financing costs and investment income:** If money has to be borrowed, this has a negative impact. If money is received up front, accrued interest until expenditure can enhance the value. This factor may be substantial.

1.3.4 Operating costs

Although the operating costs are not usually part of the capital funding budget, they are important criteria that should be considered to ensure that an animal facility is not built which cannot operate for financial reasons. Considering the useful life of a new animal facility, it has been postulated that of the total costs over time to build and operate that facility, 15 to 20% will be for design and construction and 80 to 85% will be for its operation.

All aspects, such as utility costs to maintain environmental control, mechanical maintenance (e.g., filter exchanges), personnel costs to manage the facility properly within appropriate operating procedures, costs to maintain surfaces and equipment, and waste management costs should be identified and estimated up-front.

Most significantly, it should be recognized that the manner in which individual elements will ultimately be used and operated will have a major financial impact on the yearly operational costs.

2. Design

2.1 Conceptual design

Once the program is complete, the architect and engineer should draw sketches to show the relative positions of the various spaces. It is important to leave the design to the architect and engineer in order to take advantage of the experience of these professional experts. They will often come up with designs and solutions that were not previously considered and may be far superior. Changes to the design before construction may be requested, but these should not constrain the ingenuity of the design team. The initial conceptual sketches may be fairly rough diagrams, such as that shown in Diagram 36. The conceptual designs are developed and changed until they best meet the criteria for functional adjacencies and traffic flow patterns. There may also be other criteria that must be considered in the conceptual design, such as site restrictions, existing facilities, mechanical services, etc.

2.2 Preliminary floor plans

The conceptual design that best meets the program requirements is then turned into a preliminary floor plan with straight lines, such as that illustrated in Diagram 37. This is not simply a process of changing the hand-drawn lines to straight lines. During this stage of design, the space sizes projected in the functional program become very relevant and

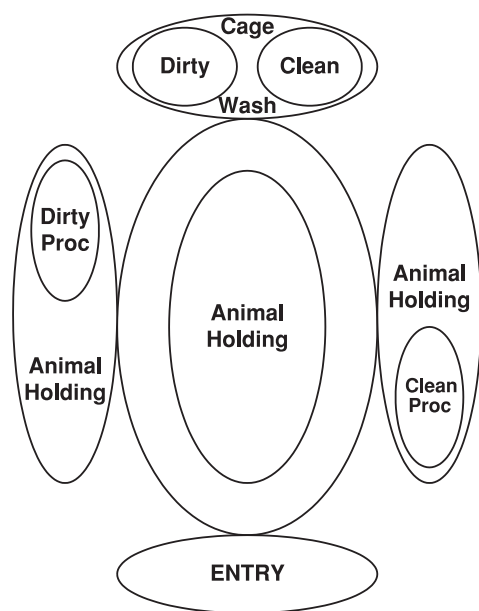

Diagram 36: Conceptual floor plan

are incorporated, where possible, into the preliminary floor plan. Various components of the animal facility are often designed separately, such as the cagewash area, surgery facility, suite of rooms, etc., and then incorporated into the overall floor plan.

2.3 Graphic test

When the design team believes they have a reasonable floor plan, it should undergo a graphic test. The design should pass this test before progressing to the next stage. This test involves evaluating the functionality of the design and asks the following questions:

- Are the traffic flow patterns correct and can they be controlled as required?
- Can corridors, doorways, anterooms, etc. accommodate the people and equipment that will be passing through them? (It is recommended that scale models of animal cage racks and other equipment be cut out of paper and moved through the floor plan as it will be after construction.)

- Are the door swings logical and functional? Are doors and rooms designed to optimize the space available?
- Are barriers located in appropriate locations and can they be changed to alter the size of barrier areas (flexible barriers)?
- Can the mechanical systems be accommodated so that they are accessible for servicing?
- Is the design such that future expansion can be accommodated?

2.4 Mechanical systems

It is important to consider how the mechanical systems will fit into the overall design. They require considerable space, especially when one considers the need for redundancy. It is also necessary that these systems be accessible for servicing, preferably from outside the facility, but at least from outside the animal holding area. All HEPA filter units must be recertified at least annually. Containment facilities must be serviced from outside the containment barrier (see AAFC, *Containment Standards for Veterinary Facilities*, 1996, <http://www.inspection.gc.ca/english/sci/lab/convet/convete.shtml>). It is prudent to develop a mock-up model of an animal holding room to check the airflow distribution by the proposed HVAC system, and to determine whether the position of the air intake and exhaust provide good distribution of air when racks and cages are present. If not, the system should be redesigned before building it into the entire facility.

2.5 Detailed design

Once the graphic tests have met the required criteria and the mechanical systems have been checked for effectiveness, the final blueprints are developed, incorporating all the details required from the functional program. It is extremely important that care be taken in developing these detailed designs since changes beyond this stage can be extremely costly.

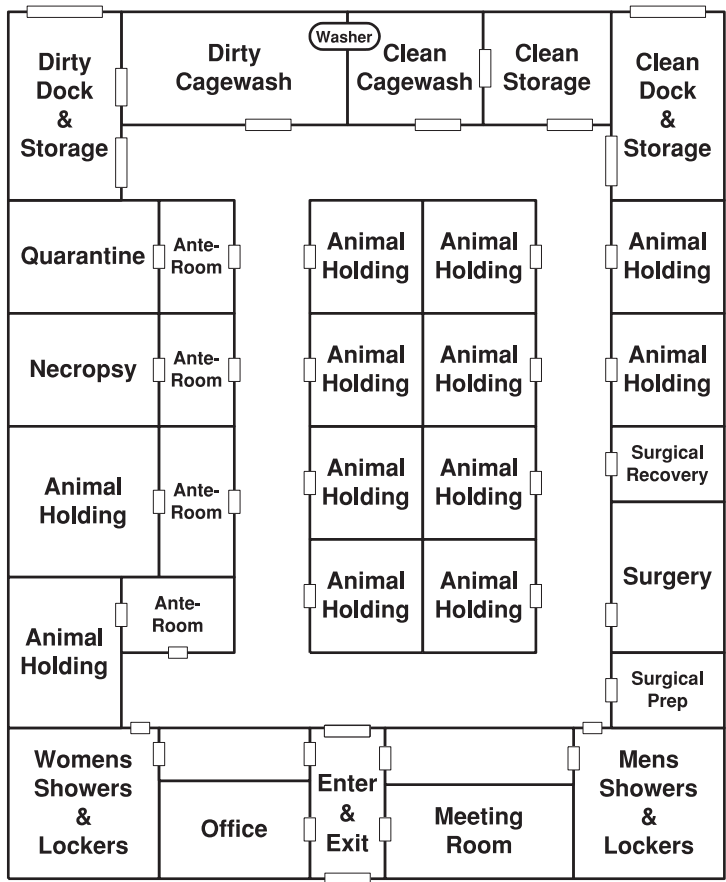

Diagram 37: Preliminary floor plan

3. Construction

The most important job of the design team at this stage of the project is quality assurance. It is highly recommended that, in addition to the architects and engineers, at least one internal quality assurance person be appointed (preferably one who will eventually be working in the facility and is familiar with the quality requirements of an animal facility). The quality of materials used and the workmanship should be checked on a daily basis to ensure they meet the program requirements. The quality and the materials specified should be used. No substitution of materials should be permitted unless previously approved. There should not be many design errors; when they do occur, the earlier they

are detected and corrected, the cheaper it will be. Detailed cost estimates of all changes should be provided prior to initiating them since these are not usually part of the original contract and may open an avenue for exorbitant charges.

4. Commissioning

Because of the complexity of laboratory animal facilities, it is essential that the commissioning process start during design and continue throughout the project. Final acceptance of the newly constructed facility entails assurance that all architectural and engineering specifications have been met. This involves testing everything in the facility to ensure that it meets the program requirements. A detailed commissioning list should be made from the program and detailed design. It should include testing and checking: the resistance of floors and walls to chemicals; the temperature, humidity and air distribution in each room; room air pressures; the functioning of redundant and emergency systems; the temperature and cycles of cage washers and autoclaves; etc. Acceptance should not occur until all deficiencies have been corrected or an agreeable plan instituted to rectify them. In particular, it may be difficult to get construction companies to take responsibility for deficiencies that are discovered after occupancy. Many institutions have had to spend considerable amounts of money to make a facility functional after occupancy. Thorough commissioning during the construction phase and prior to final acceptance should alleviate many of these problems. The success of final commissioning is dependent on earlier confirmation that all design specifications are correct.

E. REFERENCES

- Agriculture & Agri-Food Canada (AAFC) (1996) *Containment Standards for Veterinary Facilities*. 71pp. Ottawa ON: Government of Canada. Available at <http://www.inspection.gc.ca/english/sci/lab/convet/convete.shtml>
- Bellhorn R.W. (1980) Lighting in the animal environment. *Laboratory Animal Science* 30(2): 440-450.
- Canadian Council on Animal Care (CCAC) (1984) *Guide to the Care and Use of Experimental Animals*, vol. 2. 208pp. Ottawa ON: CCAC. Available at http://www.ccac.ca/english/gui_pol/guframe.htm
- Canadian Council on Animal Care (CCAC) (1993) *Guide to the Care and Use of Experimental Animals*, vol. 1, 2nd ed. 212pp. Ottawa ON: CCAC. Available at http://www.ccac.ca/english/gui_pol/guframe.htm
- Canadian Council on Animal Care (CCAC) (2003) *CCAC guidelines on: the care and use of wildlife*. Ottawa ON: CCAC. Available at http://www.ccac.ca/english/gui_pol/guframe.htm
- Canadian Council on Animal Care (CCAC) (in preparation) *CCAC guidelines on: the care and use of fish in research, teaching and testing*. Ottawa ON: CCAC.
- Canadian Council on Animal Care (CCAC) (in preparation) *CCAC guidelines on: the care and use of farm animals in research, teaching and testing*. Ottawa ON: CCAC.
- Clough G. & Fasham J.A.L. (1975) A "silent" fire alarm. *Laboratory Animals* 9(2):193-196.
- Harrison D.J. (2001) Controlling exposure to laboratory animal allergens. *ILAR Journal* 42(1):17-36.
- Health Canada (1996) *Laboratory Biosafety Guidelines*, 2nd ed. 84pp. Ottawa ON: Government of Canada. Available at <http://www.hc-sc.gc.ca/pphb-dgsp/ols-bsl/index.html>
- Heeke D.S., White M.P., Mele G.D., Hanifin J.P., Brainard G.C., Rollag M.D., Winget C.M. & Holley D.C. (1999) Light-emitting diodes and cool white fluorescent light similarly suppress pineal gland melatonin and maintain retinal function and morphology in the rat. *Laboratory Animal Science* 49(3):297-304.
- Nayfield K.C. & Besch E.L. (1981) Comparative responses of rabbits and rats to elevated noise. *Laboratory Animal Science* 31(4):386-390.
- Peterson, E.A. (1980) Noise and laboratory animals. *Laboratory Animal Science* 30(2):422-439.
- Seyfried, T.N. (1979) Audiogenic seizures in mice. *Federation Proceedings* 38(10):2399-2404.
- Swanson M.C., Campbell A.R., O'Hollaren M.T. & Reed C.E. (1990) Role of ventilation, air filtration and allergen production rate in determining concentrations of rat allergens in the air of animal quarters. *American Review of Respiratory Diseases* 141(6):1578-1581.
- Transportation of Dangerous Goods Regulations* (1992, SOR/2001-286). Available at <http://laws.justice.gc.ca/en/T-19.01/SOR-2001-286/180769.html>
- Wofle T.L. & Bush R.K. (2001) The science and pervasiveness of laboratory animal allergy. *ILAR Journal* 42(1):1-3.

F. BIBLIOGRAPHY

- Bilecki B. (2001) Integrating ventilated caging equipment with facility HVAC and monitoring systems. Facility Design and Planning, theme issue, *Lab Animal* 30:42-47.
- Frasier D. (1999) *Vivarium Sourcebook*, 2nd ed. 67pp. Newton MA: Phoenix Controls Corporation.
- Heine W.O.P. (1998) *Environmental Management in Laboratory Animal Units: Basic Technology and Hygiene — Methods and Practice*. Scottsdale AZ: Pabst Science Publishers.
- Hughes H.C. & Reynolds S. (1995) The use of computational fluid dynamics for modeling airflow design in a kennel facility. *Contemporary Topics* 34(2):49-53.
- Hughes H.C., Reynolds S. & Rodriguez M. (1996) Designing animal rooms to optimize airflow using computational fluid dynamics. *Pharmaceutical Engineering* 16(2):44-65.
- Hughes H.C. & Reynolds S. (1997) The influence of position and orientation of racks on airflow dynamics in a small animal room. *Contemporary Topics* 36(5):62-67.
- Inglis J.K. (1980) *Introduction to Laboratory Animal Science and Technology*. 321pp. Toronto ON: Pergamon Press.
- Krause J., McDonnell G. & Riedesel H. (2001) Biodecontamination of animal rooms and heat-sensitive equipment with vaporized hydrogen peroxide. *Contemporary Topics* 40(6):18-21.
- Lipman N.S. (1993) Strategies for architectural integration of ventilated caging systems. *Contemporary Topics* 32(1):7-10.
- Lipman N.S. (1999) Isolator rodent caging system (state of the art): a critical view. *Contemporary Topics* 38(5):9-17.
- Memarzadeh F. (1998) *Ventilation Design Handbook on Animal Research Facilities Using Static Microisolator*, vol. 1 and 2. Bethesda MD: National Institutes of Health. Available at <http://des.od.nih.gov/eWeb/research/farhd2/cover.htm>
- Morse B.C., Reynolds S.D., Martin D.G., Salvado A.J. & Davis J.A. (1995) Use of computational fluid dynamics to assess air distribution patterns in animal rooms. *Contemporary Topics* 34(5):65-69.
- National Research Council (2001) Laboratory Animal Allergy, theme issue, *ILAR* 42(1).
- Neil D.H. & Larsen R.E. (1982) How to develop cost-effective animal room ventilation: build a mock-up. *Lab Animal* 11(1):32-37.
- Poole T.B. (ed.) (1987) *The UFAW Handbook on the Care and Management of Laboratory Animals*, 6th ed. 933pp. Essex UK: Longman Scientific and Technical.
- Ruggiero R.F. (2001) Considerations for an automated cage-processing system. Facility Design and Planning, theme issue, *Lab Animal* 30:28-31.
- Ruys T. (ed.) (1991) *Handbook of Facilities Planning*, vol. 1: Laboratory Animal Facilities. 422pp. New York NY: Van Nostrand Reinhold.
- Tyson K.F. & Corey M.A. (2001) Facility design: forecasting space requirements. Facility Design and Planning, theme issue, *Lab Animal* 30:17-20.

G. GLOSSARY

Barrier — in the context of animal facility design, a barrier consists of physical systems and/or performance criteria that limit the transmission of etiologic agents of disease

Biocontainment — the quarantine or isolation of biohazards such as bacteria, viruses, fungi or other infectious agents that may be pathogenic to humans, animals or other forms of life

Biosafety — the proper use of containment barriers (inclusion), safety equipment and procedures to ensure the safety of all personnel, the public and the environment

Biosecurity — the prevention of animal infections and infestations from entering a unit from outside sources; biosecurity is achieved through the use of exclusion barriers

Building air envelope — a cloak of air that interfaces physically with the structure to the extent that it does not follow the movement patterns of air further away from the building

Bullnosed corners — rounded corners

Computational fluid dynamics — the use of computers to solve relevant mathematical equations in order to predict what will happen, quantitatively, when fluids or gases flow under particular circumstances; it provides information on how the fluids/gases will flow and how their flow patterns will change depending on the solid structures with which they are in contact

Etiologic agents of disease — agents that cause disease

Exclusion barriers — barriers designed to prevent the entry of animal infections and infestations from outside sources

Fomites — non-living objects that can carry disease organisms (e.g., restrainers, feeders, mops, etc.)

Genetically modified animals — animals in which there has been a deliberate modification of the genome either via a technique known as transgenesis (when individual genes from the same or a different species are inserted into another individual) or by the targeting of specific changes in individual genes or chromosomes within a single species, i.e. targeted removal of genes (knock-outs) or targeted addition of genes (knock-ins)

Immunocompromised — the condition in which the immune system is not functioning normally

Inclusion barriers — barriers designed to contain infections; they prevent the escape of agents of disease from the animals in the unit to the outside

Kilohertz (kHz) — cycles per second in thousands

Necropsy — systematic dissection of an animal after death to elucidate the cause of death; postmortem examination

Occludable — able to be closed

Sequestration — separation from others

Standard operating procedure (SOP) — written documents specifying procedures for routine activities that must be followed to ensure the quality and integrity of the study

Ventilated cage rack — a shelving unit with an integral ventilation system designed to supply fresh air to the cages stored on its shelves

Virus antibody-free — animals which do not show antibodies to viruses upon testing

Zoonotic — a disease organism that affects more than one species and can infect humans

H. ABBREVIATIONS

AAFC	— Agriculture and Agri-Food Canada	HVAC	— Heat, ventilation and air conditioning
BB	— Bio-breeding (a strain of insulin-dependent diabetic rats)	Hz	— Hertz
BSC	— Biosafety cabinets	kHz	— Kilohertz
BSE	— Bovine spongiform encephalopathy	LED	— Light emitting diode
BTU	— British thermal units	nm	— Nanometres
CFIA	— Canadian Food Inspection Agency	NOD	— Non-obese diabetic (mice)
CFM	— Cubic feet per minute	RH	— Relative humidity
CJD	— Creutzfeldt Jakob Disease	SCID	— Severe combined immunodeficiency
CNSC	— Canadian Nuclear Safety Commission	SOP	— Standard operating procedure
CWD	— Chronic wasting disease	SPF	— Specific pathogen-free
dB	— Decibel	VAF	— Viral antibody-free
GFI	— Ground fault interrupter	VCJD	— Variant Creutzfeldt Jakob Disease
HC	— Health Canada	VCS	— Ventilated cage systems
HEPA	— High efficiency particulate air		

APPENDIX A

SUMMARY OF RELEVANT GUIDELINES

The following is a summary of guidelines referred to throughout this document.

Canadian Council on Animal Care, *Guide to the Care and Use of Experimental Animals*, vol. 1, 2nd ed., 1993.

Table I: Recommended Codes of Practice for the Care and Handling of Farm Animals

Species	Agriculture and Agri-Food Canada Publication	Date
Mink	1819/E	1988
Poultry: Pullets, Layers, and Spent Fowl		2003
Chickens, Turkeys and Breeders from Hatchery to Processing Plant		2003
Dairy Cattle	1853/E	1990
Beef Cattle	1870/E	1991
Pigs	1898/E	1993
Addendum Early Weaned Pigs		2003
Horses		1998
Veal Calves		1998

The above are available from the Canadian Agri-Food Research Council (CARC), Ottawa, ON.

The most up-to-date editions of the following publications should be consulted. At the time of printing, these are:

- Health Canada (1996) *Laboratory Biosafety Guidelines*, 2nd ed. Available through Health Canada's Population and Public Health Branch, Laboratory Centre for Disease Control, <http://www.hc-sc.gc.ca/pphb-dgspsp/ols-bsl/index.html>
- Agriculture and Agri-Food Canada (1996) *Containment Standards for Veterinary Facilities*. Publication no. 1921/E. Available at <http://www.inspection.gc.ca/english/sci/lab/convet/convete.shtml>. Responsibility for these standards now rests with the Canadian Food Inspection Agency, Laboratories Directorate, Biohazard Containment and Safety Division, <http://www.inspection.gc.ca/english/sci/lab/bioe.shtml>

APPENDIX B

EXAMPLES OF DETAILED SPACE DESCRIPTIONS

EXAMPLE 1

No. Required:	25
I.D. No.	M-1
Space Name:	Conventional Animal Room
Location:	Medical Sciences Building, University of Alberta
Size/Configuration:	9.29 m ² (10' x 10'; or 100 ft ²)
Purpose:	Holding small animals. Depending upon exact size and obstructions (columns, etc.), will hold between two and four small animal racks. Not intended for large animals.
Chemicals/Pathogens:	Conventional
Relationships:	Access from conventional corridor with unidirectional traffic flow from restricted access corridor to general access corridor.

ARCHITECTURAL	Floors	Seamless epoxy with integral cove base
	Walls	Epoxy paint on concrete block
	Ceilings	Epoxy paint on drywall
	Doors	<ul style="list-style-type: none"> • 112 cm x 213 cm (44" x 84") • Hollow Metal (H.M.) with view light • H.M. frames grouted solid
	Hardware	Push, pull, closer, armor plate, weatherstrip, door bottom, hold open, deadbolt
	Cabinetry	76 cm (30") stainless steel shelf above sink
MECHANICAL	HVAC	<ul style="list-style-type: none"> • 15 air changes per hour • Temperature 18°C to 26°C, ± 1°C • 50% relative humidity, ± 10% • Use 30% filters in lieu of exhaust grilles
	Plumbing	Stainless steel handwash sink with wrist blades

ELECTRICAL	Lighting	<ul style="list-style-type: none"> • 650 lux (60 foot candles) recessed vapor-proof fluorescent with smooth lenses, double-switched half lamps to timed wall switch, half lamps to central lighting control computer • 1085 lux (100 foot candles) at sink on timed wall switch • Three weatherproof GFI duplex outlets on circuit dedicated to room plus one 20 amp outlet on dedicated circuit
	Communications	
EQUIPMENT	Fixed	
	Moveable	Occasional laminar flow rack ($\frac{1}{2}$ h.p. motor)
	Miscellaneous	Vacuum hose connection to corridor, vacuum hose hook, mop, hooks, paper towel dispenser

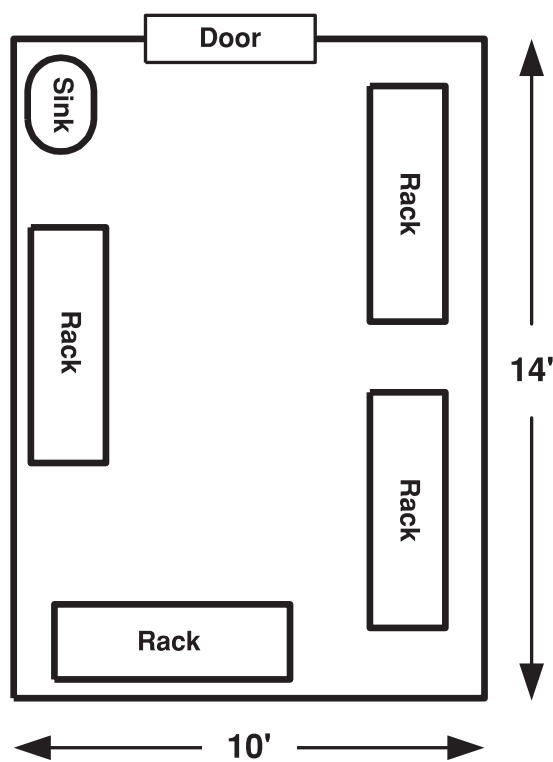

Diagram I: Conventional rodent room

EXAMPLE 2

No. Required:	10
I.D. No.	M-3
Space Name:	Cubicle Room
Location:	Medical Sciences Building, University of Alberta
Size/Configuration:	31.6 m ² (340 ft ²) with 7 alcoves with full glass aluminum doors and frames
Purpose:	Provide individual housing for one rack per alcove without tying up an entire room
Chemicals/Pathogens:	Conventional
Relationships:	On general access corridor and west end mono-directional corridors

ARCHITECTURAL	Floors	Seamless epoxy with integral cove base
	Walls	Epoxy paint on concrete block
	Ceilings	Epoxy paint on drywall
	Doors	<ul style="list-style-type: none"> • 112 cm x 213 cm (44" x 84") • Hollow Metal (H.M.) with view light • H.M. frames grouted solid • To cubicles: pair aluminum doors
	Hardware	<ul style="list-style-type: none"> • To room: push, pull, closer, armor plate, weatherstrip, door, bottom, hold open, deadbolt • To cubicles: lock, pull, hold open, flush bolt (head only)
	Cabinetry	Stainless steel countertop with lockable wall cabinet above
MECHANICAL	HVAC	<ul style="list-style-type: none"> • 15 air changes per hour • Supply and exhaust in each cubicle • Temperature 18°C to 26°C, ± 1°C of setpoint • 50% relative humidity, ± 10% • Use 30% filters in lieu of exhaust grilles
	Plumbing	Stainless steel handwash sink with wrist blades

ELECTRICAL	Lighting	<ul style="list-style-type: none"> • 650 lux (60 foot candles) recessed vapor-proof fluorescent with smooth lenses, double switched • Half lamps to timed wall switch, half lamps to central lighting control computer • 1085 lux (100 foot candles) at sink on timed wall switch • One weatherproof GFI duplex outlet at 198 cm (6'6") above finished floor in each cubicle and at 107 cm (3'6") at counter • Dedicated circuit for room
	Communications	Intercom
EQUIPMENT	Fixed	
	Moveable	
	Miscellaneous	<ul style="list-style-type: none"> • Vacuum hose connection to corridor, vacuum hose hook, mop • Hooks in every cubicle and in common area, paper towel dispenser

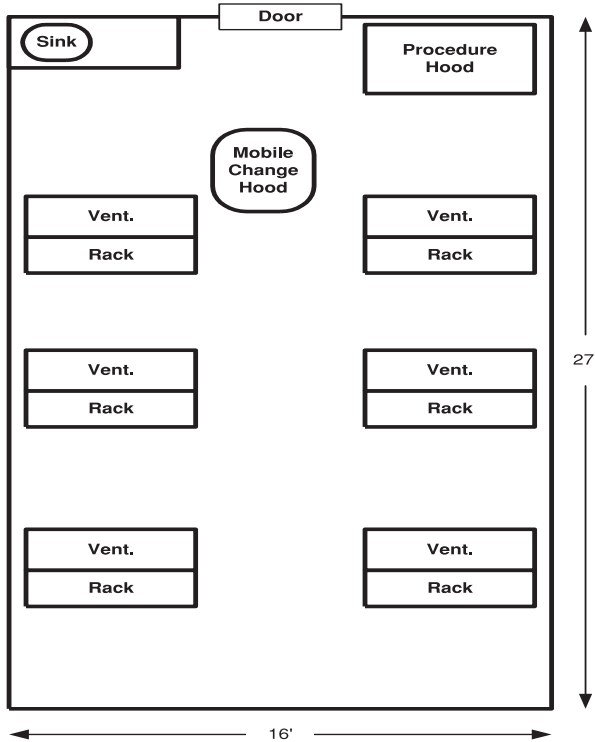

Diagram II: Rodent room with double-sided ventilated racks

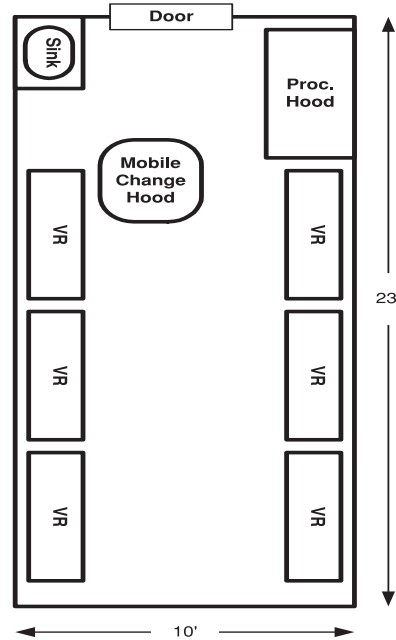

Diagram III: Rodent room with single-sided ventilated racks

AN EXAMPLE OF A MORE COMPARTMENTALIZED SPACE PROGRAM

SPACE PROGRAM DATA SHEET		
NAME OF INSTITUTION: _____ PROJECT NUMBER: _____		
IDENTITY OF SPACE: _____		
GENERAL LOCATION (ZONE OR SUITE): _____		
ARCHITECTURAL CRITERIA	Function	
	Area required	
	Number of cages	
	Number and description of racks	
	Maximum personnel at any one time	
	Biosecurity status	
	Biosafety status	
	Required sound isolation (sound transmission coefficient)	
FUNCTIONAL ADJACENCIES	Primary	
	Secondary	
PHYSICAL ADJACENCIES		
MATERIALS AND FINISHES	Floors (material)	
	Finish (non-slip, etc.)	
	Floor to wall junction (e.g., integral cove base)	
	Walls (material)	
	Finish(es)	
	Ceilings (height)	
	Material	
	Doors (material)	
	Window or viewing ports	
	Frame	
	Jamb protection	
	EQUIPMENT	Biological safety cabinet
Fume hood		
Work station (size)		
Other		

HVAC	Temperature setpoint	
	Relative humidity	
	Heating	
	Cooling	
	Directional airflow	
	Air changes per hour	
	Air exhaust	
	Air supply	
	Special room filtration	
	Special exhaust	
	Heat generating equipment	
	Mechanical noise criteria	
	Other	
POWER RECEPTACLES	Special equipment	
	Emergency (quantity)	
	GFI (quantity)	
	Dedicated circuits (quantity)	
	Other	
LIGHTING	Light type	
	Light intensity	
	Special lighting	
	Other	
COMMUNICATIONS	Telephone (quantity)	
	Data (quantity)	
	Other	
PLUMBING	Cold water	
	Hot water	
	Purified water	
	Animal water	
	Vacuum	
	Oxygen	
	Natural gas	
	CO ₂ gas	
	Other gases	

	Sink(s)	
	Cup sink	
	Eyewash	
	Safety shower	
	Floor drain(s)	
	Hose bib	
	Mixing station	
	Other	
FIRE PROTECTION	Sprinkler system	
	Extinguisher	
	Fire alarm	
	Horn	
	Strobe	
	Other	
SECURITY/ MONITOR	Security access	
	Badge reader	
	Special monitoring	
HAZARDOUS STORAGE	Flammable	
	Chemical	
	Safety closet	
	Other	
COMMENTS:		

APPENDIX C

A SIMPLIFIED EXAMPLE OF PRELIMINARY SIZE ESTIMATION FOR AN ANIMAL FACILITY

This is an exercise in estimating the size and scope of an animal facility for a small institution with six investigators.

In Tables I to VI, the experimental animal activity of six investigators is broken down. For example, Dr A. and his team are researching the development of diabetes using strains of rats and mice which develop the disease naturally. It is important to note that the information in the various columns is compiled as a result of interactions between the investigator, the laboratory animal veterinarian and the animal facility manager.

Determining the number of cages is simple arithmetic, if the number of animals to be held is known. The same applies to the number of racks on which the cages are held. It is necessary to have determined the types of caging systems to be used at this early stage, or at least to have narrowed it down sufficiently to develop some idea of the sizes of the racks to be used and the number of cages per rack.

Finally, the different zones or suites and compartments within them (e.g., modified barrier, perinatal sheep suite, etc.) are identified. The service units, such as the cagewash and storage areas, are added. All spaces are sized ergonomically to facilitate their function, and their adjacencies are considered. At this time, it is possible to get an approximate estimate of the total number of square metres needed to house these functions. What remains is the space required to effectively circulate people, animals and material around the facility. This stage, however, is prior to the development of a graphic test or tentative floor plan. An efficiency factor can be used to extrapolate the net utilizable space required into gross space. The efficiency factor is usually expressed as a

percent of the net area, to which it is added. Renovations are usually associated with greater inefficiencies of space utilization, and hence, may have an efficiency factor of 55%, as compared to a new building at 40%.

Using the standard industry guide for the region in which the project is located, a cost per gross square metres (or feet) can be used to give some useful idea of the match between the size and scope of the facility needed and the funds available or required.

Note that under 'comments', the BB rats are disease-free. The mice, however, have a known parasitic worm infestation and are not designated disease-free. They are designated 'conventional' which means they could be infected with other mouse diseases as well. As a result, the rats will be housed in a modified barrier area, whereas the mice will be housed in a conventional access area (i.e. minimal barriers).

In our modified barrier, food and bedding are autoclaved. Drinking water is sterilized and sterile hats, masks, gowns, gloves and disinfected rubber boots are used to enter the area.

Although the mice, being conventional, are not sheltered from infection in the same way, they will be placed in an area or zone where the parasitism will be kept under control by separation, treatment and stringent disinfection.

The point is that the integration of adequate information requires input from all the members of the planning team, with respect to animal rooms and the type of zone in which they are to be located, and not from any one individual.

**Table I: DR A. and TEAM
DIABETES INTERDISCIPLINARY STUDY**

Species	Status	Number held at any one time	How they are housed: group, singly, etc.	Cages	Racks, runs, pens, etc.	Comments	Compartments	Number of compartments	Where
B.B. Rats (Insulin Dependant)	Disease-free	100	Pairs and singly	75	3 racks	From disease-free colony	3 or 4 rack room (or 4 cubicle suite)	1 room	In modified barrier
NOD Mice	Conventional	300	50/50 pairs and fours	90-100	4 racks	Parasitism, serological status unknown	4 rack room (or 4 cubicle suite)	1 room or cubicle suite	Conventional access area

**Table II: DR B. and TEAM
LIPID, LIPOPROTEIN METABOLISM MOLECULAR BIOLOGY**

Species	Status	Number held at any one time	How they are housed: group, singly, etc.	Cages	Racks, runs, pens, etc.	Comments	Compartments	Number of compartments	Where
Rats (Zucker)	Conventional	120	Singly	120	5 racks	Mycoplasma – contain known infection	5 cubicle suite	1 cubicle suite	Conventional access area
Rats (SD)	Disease-free	300	Singly and in pairs	225	9 racks	From disease-free colony – barrier	3 or 4 rack room (or cubicle suites)	3 rooms 3 suites	Modified barrier
Mice	Transgenic – 3 strains	10 cages for breeding triads 10 for separating pregnant females weaned mice held to 8 weeks, 20-30 weanlings per week	One male, 2 females Pregnant females separated Weanlings caged in groups of 4	62 per strain TOTAL 186 for 3 strains	2 double-sided ventilated isolator cage system (VCS) 98 cages per rack plus change station	Free of all murine pathogens	2 double-sided 98 cage VCS	One animal room	Full barrier zone

**Table III: DR C. and TEAM
TRANSPLANTATION AND XENOGRAFTING**

Species	Status	Number held at any one time	How they are housed: group, singly, etc.	Cages	Racks, runs, pens, etc.	Comments	Compartments	Number of compartments	Where
Mice	Nude (nu/nu)	120	Pairs	60	3 racks	Immuno deficient – barrier	3 or 4 rack rooms – cubicle suite	1 room 1 cubicle suite	One large cubicle suite in modified barrier
Mice	SCID	20	Pairs	10	1 rack	Immuno deficient – barrier	Cubicle	1 cubicle	
Rabbit	Disease-free (gnotobiotic origin)	60	Singly	60	10 racks	Naïve to infection	5 rack or 4 rack room	2 to 3 rooms	Modified barrier

**Table IV: DR D. and TEAM
BACTERIAL DISEASES, IMMUNOPROPHYLAXIS
(BIOCONTAINMENT LEVEL II)**

Species	Status	Number held at any one time	How they are housed: group, singly, etc.	Cages	Racks, runs, pens, etc.	Comments	Compartments	Number of compartments	Where
Mice	Disease-free (VAF) barrier maintained	200	Fours	50	2 racks	Barrier and biocontainment	Cubicles	1 cubicle suite	Bio-containment (with naive animals)
Guinea Pigs	Disease-free barrier maintained	20	Singly	20	1 rack	Barrier and biocontainment	Cubicle	1 cubicle suite	
Rabbit	Pasteurella, coccidia, encephalitozoon free	20	Singly	20	4 racks	Treat as healthy rabbits. Make sure no conventional contact. No disease-free rabbit contact	Cubicles or 4 rack room	1 room or cubicle suite	

**Table V: DR E. and TEAM
CYSTIC FIBROSIS TREATMENT
RHEOLOGY OF BRONCHIAL MUCUS**

Species	Status	Number held at any one time	How they are housed: group, singly, etc.	Cages	Racks, runs, pens, etc.	Comments	Compartments	Number of compartments	Where
Beagles	S.P.F.	16	Pairs	-----	8 Runs	8 runs - modified barrier. No contact with any pound dogs	5 run rooms	2 rooms	Modified barrier, noise isolated

**Table VI: DR F. AND TEAM
PERINATOLOGY**

Species	Status	Number held at any one time	How they are housed: group, singly, etc.	Cages	Racks, runs, pens, etc.	Comments	Compartments	Number of compartments	Where
Sheep	Timed pregnant, farm source	6	Singly	-----	6 Pens	Must assume Q fever - always possible	6 pen room	1 large animal room	Sequestered suite - a large animal biocontainment unit (negative pressure)

Summation:

After reviewing the information relevant to each investigator, the information can be summarized and the types of zones needed to accommodate the required species of different status determined. Thus, for the six investigators in this hypothetical institution, the number and type of zones required can be determined.

Concentrating on the last four columns in Tables I to VI, the following functional zones may be identified and grouped. (Note: where rooms are favored over cubicles, anterooms may be stipulated in configuring room conformations in the detailed space program.)

Table VII: SUMMARY

Conventional Access	1 room or cubicle suite of NOD mice 5 cubicle suites of Zucker rats
Conventional Access Noise Isolated	4 five-run rooms of conditioned pound dogs
Modified Barrier	1 room or cubicle suite of BB rats 1 room or cubicle suite of transgenic mice 2 rooms or cubicle suites of SD rats (disease-free) 1 cubicle for immunocompromised mice 3 four-rack rooms (with anterooms) for rabbits (disease-free)
Modified Barrier Noise Isolated	2 five-run rooms (with anterooms) for SPF beagles
Full Barrier	Enigmatic in early stages of the program. There is a need for one room containing 2 VCS at the full barrier level immediately. Initially, a modified barrier is all that may be needed if the operating procedures are stringent enough. In this, as in most cases, growth of the unit is anticipated so that some elasticity is needed for this (i.e. an expandable barrier or modified barrier unit is desirable). Thus the personnel and material access is physically facilitated initially (autoclave, showers, etc.). In an expandable barrier, the design and adjacencies make it possible for the animal rooms to be annexed to the full barrier as needed.
Biocontainment	1 cubicle suite (5 rack) for mice and guinea pigs 1 cubicle suite (5 rack) for rabbits 1 suite for the care and use of pregnant sheep (6 pens) - with the capability for major abdominal surgery and monitoring of the live fetus.

APPENDIX D

TRAFFIC FLOW PATTERNS

Facilitation of the logical movement of personnel, animals, food, and various items of equipment around, and in and out of, the animal facility necessitates careful planning. For those unfamiliar with the day-to-day workings of an animal facility, it is necessary to visit one at its busiest time to appreciate not only the variety of movement, but the considerable volume of traffic as well. Traffic flow is, therefore, a very important consideration, and effective planning based on sound concepts and principles will have a major impact on the usefulness of the facility.

Generally, items and different categories of people can be split into 'clean' and 'dirty' (or 'soiled') designations. These simplistic terms are used to differentiate between those things (animate and inanimate) that may potentially transport infections or noxious substances from place to place, and those that are uncontaminated and unthreatening.

To those unfamiliar with animal facilities and their operation, it is quite possible for an item

or person to look clean, but in effect be classified as 'dirty'. For example, some unused clean cages from an animal room in which animals are being housed, when removed from the room are technically as dirty as those in which animals (e.g., mice) have been housed that actually contain bedding mixed with hair, dander, feces and urine.

The terms contaminated and uncontaminated (and decontaminated) could be used, but these are important terms when dealing with known infections and biohazards. They are, therefore, reserved for that purpose; for general management purposes, the terms 'clean' and 'dirty' prevail.

The importance of designating 'clean' and 'dirty' in the list of personnel, animals, food, waste materials, and items of equipment which must be moved around, in and out of the animal facility, becomes apparent in the following table.

Table I: Animals, Personnel, Food and Equipment on the Move in an Animal Facility

ITEM	STATUS	MOVEMENT
Animals for research, teaching and testing	Clean	The vast majority of rodents now being received by facilities from commercial vendors are free of infections and infestations. They are received at a <u>clean dock</u> and will either move to a quarantine area or directly to a clean animal room.
	Dirty	<u>Random source</u> animals (e.g., dogs originally from a pound) and most farm species are <u>dirty</u> and are received at the <u>dirty dock</u> . Their movement is deemed dirty and incompatible with disease-free rodents.

Table I: Animals, Personnel, Food and Equipment on the Move in an Animal Facility (continued)

ITEM	STATUS	MOVEMENT
Investigators, including post-doctoral fellows, graduate students and technical staff, in the laboratories	Initially dirty then variable	The status of the scientific community in the adjacent laboratories is unknown. Their leisure contact with animals is unknown. On coming to the animal facility, they need to remove top clothes and at least don a clean lab coat and sometimes facility footwear in a <u>locker room</u> . For those going to disease-free animals, a complete change to clean coveralls or scrub suits might be necessary. Investigators leaving <u>biocontainment zones</u> shower-out at that point.
Laboratory animal service personnel, including laboratory animal technicians and the attending veterinarian	Initially dirty from home, commencing work clean, subsequently variable	On arriving at work, the staff members of the animal facility change completely into clean work clothes (coveralls, scrub suits, etc.), and facility footwear (personal). Each employee then travels through the facility dealing with clean and dirty functions, preferably in an either/or situation. If they do both clean and dirty tasks, the clean ones are completed first. In the most complex scenario, showering and changing are required when going from dirty to clean or elevating status, e.g., entering a designated disease-free zone (a barrier zone) from the general facility. Personnel, on leaving <u>biocontainment zones</u> , shower-out at that point.
Plant maintenance personnel	Dirty	<u>Preventative maintenance</u> is essential in the mechanically intensive facility. The facility should be <u>friendly</u> to the plant maintenance staff. In newer facilities, much of their work is confined to spaces adjacent to the facility floor in locations such as interstitial, epistitial, or core areas. Working within the facility proper may require changing.
Security personnel	Dirty	This is an important feature. It is necessary but problematic in certain zones to have adequate surveillance. Electronic alarms and video scans are useful. Windows can be another advantage (internal). Actual physical movement of security personnel must be restricted.
Fresh bedding	Clean/dirty (dubious)	Shavings, sawdust and other bulk products are of <u>doubtful origin</u> . Bagged bedding materials tend to be less problematic <u>if the bags are clean, undamaged and dry</u> . Bedding should be received <u>clean</u> , but held in a peripheral location until it is examined, possibly treated (autoclaved) and then distributed.

Table I: Animals, Personnel, Food and Equipment on the Move in an Animal Facility (continued)

ITEM	STATUS	MOVEMENT
Food	Clean (especially inside the bags, exterior dubious) but not barrier ready	Food from the reputable manufacturers is cleanly bagged in designated plants, being pasteurized by the heat of manufacture. It is received at a <u>clean dock</u> , treated and stored, preferably close to the point of receipt. Distribution from then on is in clean containers and certain foods may be <u>autoclaved</u> for entry into <u>barrier zones</u> .
Cages and racks, and items for animal containment	Clean	Cages, etc., are washed in water reaching a temperature of 180°F (approximately 83°C). They are NOT strictly sterile but referred to as <u>sanitized</u> . They move from the <u>clean side of the cagewash area</u> to the designated zone of use. They may be <u>autoclaved</u> into a <u>barrier zone</u> . Where <u>clean cages</u> are moved through areas where cross-contamination theoretically may occur, they are <u>containerized</u> , either in hard-shell containers or covered with clean fitted soft covers (plastics or cloth fabrics), sometimes aptly referred to as ' <u>toaster covers</u> '.
	Dirty	Dirty cages, etc. are moved to the <u>dirty side of the cagewash area</u> for soil elimination and washing. From this point, soiled bedding must be moved in the most direct and shortest way to the dumpster or incinerator. Again, ' <u>toaster covers</u> ' may be needed en route.
Dry goods	Clean, but not necessarily barrier ready	These are sponges, paper towels, disposable items of protective clothing, etc. for general distribution received at the clean dock, stored adjacent, and distributed directly to points of use. In the case of barriers, the containers may require surface disinfection. Autoclaving is a barrier option also.
Soiled bedding material	Dirty (very)	Soiled bedding is usually moved in the dirty cages to the <u>dirty side of the cagewash area</u> . It can transport easily transmissible infectious diseases of the animals themselves (not experimentally induced). For this reason, the cages may be covered during transit. After removal from the cages, the soiled bedding must move to the <u>dirty dock</u> and then to a closed dumpster or to the incinerator. The route <u>must be short and direct</u> (see functional adjacencies). Dirty cages, etc. from a <u>biocontainment facility</u> may be <u>autoclaved out</u> of the zone prior to washing.

Table I: Animals, Personnel, Food and Equipment on the Move in an Animal Facility (continued)

ITEM	STATUS	MOVEMENT
Hazardous waste material	Dirty	When this is an item to be dealt with, designated storage is required, preferably close to the dirty dock from which it can be moved from the facility. Dirty cages containing hazardous waste material may need to be <u>containerized</u> for transport from the animal room to the <u>decontamination zone</u> adjacent to the <u>dirty side of the cagewash area</u> .
Radioactive materials	Dirty	Depending on the half-life of the radionuclide used, the material (e.g., soiled bedding) will need to be collected in a designated zone and then stored until decay has occurred, or be transported to another location for decay. In cases where gamma emissions occur, specially shielded containerization of soiled equipment may be required prior to movement.
Dead animals	Dirty	Dead animals are collected, identified and moved to cold storage which is usually adjacent to the necropsy room. Dead animals and tissues from necropsy are transported to the incinerator or dispatched to another location for incineration via the <u>dirty dock</u> . Radioactive animals and tissues are stored frozen in radioactive waste storage until harmless.

APPENDIX E

HEAT PRODUCTION

Table I: Approximate Heat Production by Various Animal Species

Animal	Individual Weight		Total Heat Produced	
	lb	kg	BTU/hr/lb	KJ/hr/kg
Mouse	0.05	0.02	65	149
Baby Chick	0.10	0.05	28	62
Hamster	0.24	0.11	34	74
Pigeon	0.61	0.28	38	84
Rat	0.66	0.30	34	76
Guinea Pig	0.90	0.41	32	71
Chicken	2.00	0.91	15	33
Rabbit	6.00	2.72	20	44
Cat	7.00	3.18	19	42
Monkey	9.00	4.08	19	42
Dog	35.00	15.88	10	22
Goat	79.00	35.83	8	18
Sheep	99.00	44.91	10	22
Pig	25.00	11.34	9	20
Hog	550.00	249.48	7	16
Calf	300.00	136.08	5	11
Cow	1000.00	453.60	3	7
Horse	1000.00	453.60	3	7
Human Adult	150.00	68.00	4	9

Factors causing variability in these figures are: room temperature; relative humidity; and levels of activity and stress of the animals, both of which affect metabolic rate.

